



EMUGE

Gewindeschneidtechnik · Spanntechnik
Thread Cutting Technology · Clamping Technology



Katalog 150

Gültig ab 1. November 2016

Catalogue 150

Valid from 1 November 2016

Im Rahmen der technischen Weiterentwicklung und Programmbereinigung behalten wir uns vor, dass im Katalog angebotene Werkzeuge nicht mehr in der bisherigen Form lieferbar sind. In diesen Fällen beraten Sie unsere Mitarbeiter gerne bezüglich geeigneter Ersatzwerkzeuge.

Änderungen jeder Art oder Druckfehler von technischen Daten berechtigen nicht zu Ansprüchen. Bildliche Darstellungen sind nicht verbindlich.

Nachdruck von Text und Bildern, auch auszugsweise, ist ohne unsere Genehmigung nicht gestattet.

Due to technical development and programme adjustments, we reserve the right to discontinue any tools in the present form offered in the catalogue. In these cases, our staff will be happy to advise you with regard to suitable replacement tools.

Changes of any kind, or printing errors regarding technical details, do not justify any claims. All pictures are without obligation.

Reprinting of text or pictures, or extracts thereof, is not allowed without our prior permission.

EMUGE-Werk Richard Glimpel GmbH & Co. KG

Fabrik für Präzisionswerkzeuge

 Nürnberger Straße 96-100
91207 Lauf
GERMANY

 +49 9123 186-0

 +49 9123 14313

 info@emuge-franken.com

 www.emuge-franken.com

	<p>1</p>	<p>15 - 266</p> <p>Gewindebohrer Taps</p>		
	<p>2</p>	<p>267 - 324</p> <p>Gewindeformer Cold-Forming Taps</p>		
	<p>3</p>	<p>325 - 472</p> <p>Gewindefräser Thread Milling Cutters</p>		
	<p>4</p>	<p>473 - 506</p> <p>Schneideisen Dies</p>		

	<p>507 - 580</p> <p>Spiralbohrer Twist Drills</p>	<p>5</p>
	<p>581 - 654</p> <p>Gewindelehren Thread Gauges</p>	<p>6</p>
	<p>655 - 836</p> <p>Aufnahmen und Gewindeschneidapparate Tap Holders and Tapping Attachments</p>	<p>7</p>
	<p>837 - 871</p> <p>Allgemeine Informationen General Information</p>	<p>8</p>



Rund 100 Jahre Präzision und Innovation. Nearly 100 years of precision and innovation.

EMUGE als Teil der EMUGE-FRANKEN Unternehmensgruppe entwickelt und produziert Präzisionswerkzeuge für die Gewindeherstellung, die Werkzeug- und die Werkstückspannung. Das vielfältige Programm verfolgt dabei das Ziel, eine Werkzeug-Systemlösung ab der Maschinenspindel bis zur Fixierung des Werkstücks anzubieten.

Gewindebohrer, Gewindeformer und Gewindefräser stehen für eine Vielzahl an Abmessungen und Werkstoffen zur Verfügung. Für hervorragende Bohrungsqualität sorgen Spiralbohrer, die zudem perfekt auf die Gewindewerkzeuge abgestimmt sind. Ein ausgewähltes Programm an Schneideisen und Gewindevälzrollen ermöglicht die zuverlässige Herstellung von Außengewinden.

Zahlreiche Werkzeug-Aufnahmen und Gewindelehren vervollständigen den Systemgedanken und tragen durch ihre Produktmerkmale zur Produktivitätserhöhung bei.

EMUGE as part of the EMUGE-FRANKEN company association develops and manufactures precision tools for thread production and for the clamping of tools and workpieces. The diverse programme aims at offering a tool system solution from the machine spindle to the clamping of the workpiece.

Taps, cold-forming taps and thread milling cutters are available for a variety of dimensions and materials. Twist drills provide an excellent drill hole quality, which are also perfectly adapted to the threading tools. A selected range of dies and thread rolls enables the reliable production of external threads.

Numerous tool holders and thread gauges complete the system-based approach and their product features contribute to an increase in productivity.



Vertriebsgebiete und Produktionsstandorte in Deutschland
Sales areas and production locations in Germany



FRANKEN – Unser Schwesterwerk in Rückersdorf

Als Systemlieferant im Bereich Frästechnik bietet FRANKEN ein breites Spektrum an Hochleistungswerkzeugen für die moderne Fertigung. Mit seiner Typen- und Schneidstoffvielfalt, dem hohen Standard und der kompromisslosen Präzision entsprechen diese Werkzeuge höchsten Qualitätsanforderungen und sind für fast alle Werkstückmaterialien geeignet. Ein durchgängiges System an Fräsespannmitteln rundet das Lagerprogramm ab.

FRANKEN – Our sister company in Rückersdorf

As a system supplier in the field of milling technology FRANKEN offers a wide range of high-performance tools for the modern production. These tools meet the highest quality requirements thanks to their wide range of designs and cutting material and the high standard of uncompromising precision, and are suitable for almost all workpiece materials. A consistent range of milling chucks completes the stock programme.

Wir sind in Ihrer Nähe. Weltweit. We are nearby. Throughout the world.

EMUGE-FRANKEN ist heute in allen wichtigen Industrienationen der Erde vertreten. Über 400 Kundenberater stehen weltweit im direkten Kundenkontakt und sorgen flächendeckend für eine individuelle Beratung vor Ort. Neben einer anwendungsspezifischen Beratung erarbeiten wir auch Konzepte zur Optimierung Ihres Fertigungsablaufes oder entwickeln eigens für Sie Sonderwerkzeuge.

Ganz gleich, wo unsere Präzisionswerkzeuge und unsere Leistungsvielfalt gefragt sind – wir sind in Ihrer Nähe.

Today EMUGE-FRANKEN is represented in all important industrial nations around the world. More than 400 customer consultants guarantee the direct contact with the customer and provide individual comprehensive consultation on-site. In addition to offering application-specific advice, we also prepare concepts for optimizing your production process or develop special tools specifically for you.

No matter where our precision tools and our range of services are required – we are nearby.

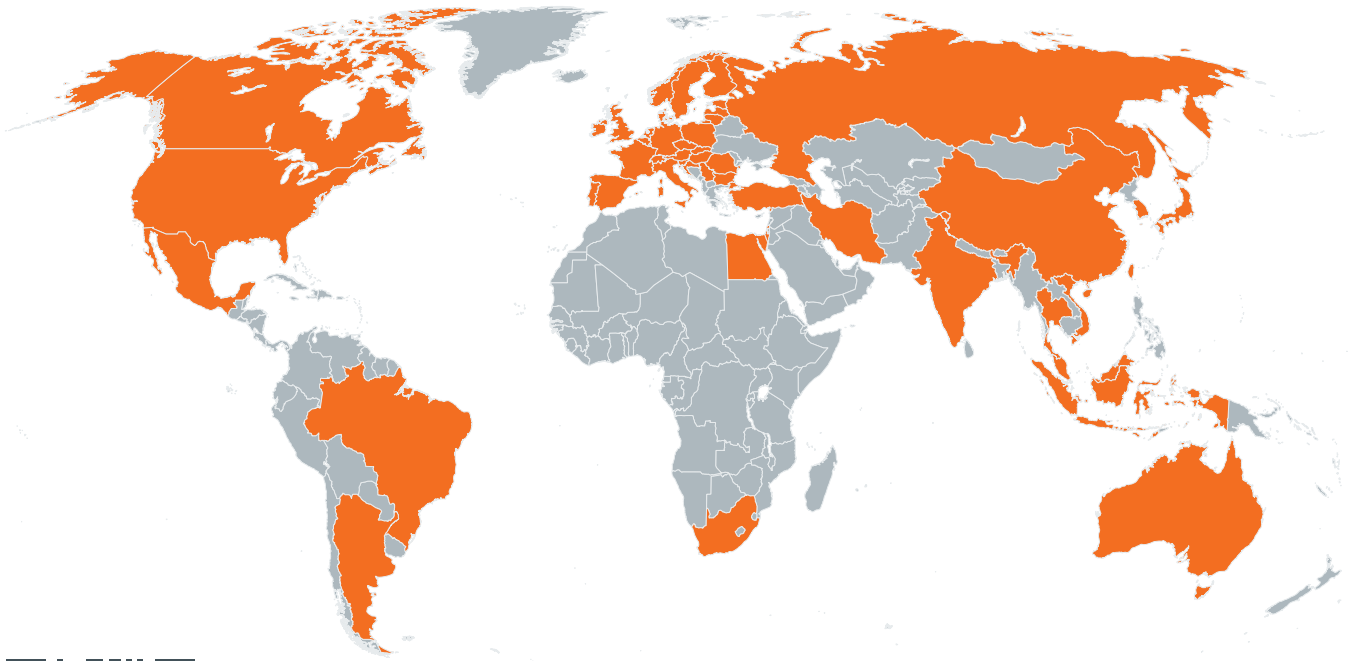

Ihren EMUGE-FRANKEN Ansprechpartner finden Sie auf www.emuge-franken.com/vertrieb
To find your EMUGE-FRANKEN contact person, please see www.emuge-franken.com/sales

Die EMUGE Punch Tap-Technologie stellt neben Gewindebohren, Gewindeformen und Gewindefräsen eine weitere Technologie zur Gewindeherstellung dar.



Mit ihrem innovativen, sehr kurzen Bewegungsablauf eröffnet sie eine völlig neue Dimension der Produktivität.

Die Grundidee der Kinematik gliedert sich in drei Arbeitsschritte. Voraussetzung ist eine Vorbohrung im Werkstück mit dem entsprechenden Vorbohrdurchmesser.

The EMUGE Punch Tap technology constitutes besides tapping, cold-forming of threads and thread milling another technology for thread production.

Thanks to its innovative, very short motion process, it establishes an entirely new dimension of productivity.

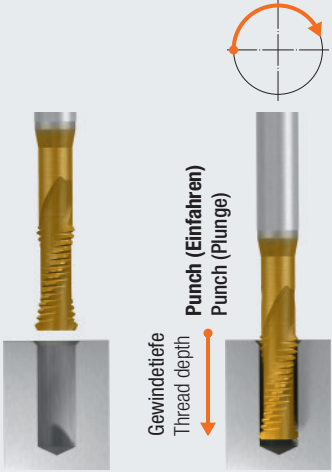
The basic idea of the kinematics is divided into three working steps. A drilled pilot hole in the workpiece with the suitable preparatory diameter is required.

Schritt 1 · Step 1	Schritt 2 · Step 2	Schritt 3 · Step 3
 <p>In der vorgefertigten Bohrungswand entstehen zwei Helikalnuten. Two helical grooves are generated in the pre-machined wall of the hole.</p>		
<p>Schritt 1: Punch (Einfahren)</p> <p>Der Punch Tap besitzt kein durchgehendes Gewindeprofil am Umfang, sondern nur zwei Zahnreihen, die um 180° versetzt angeordnet sind. Dabei übernimmt der erste Zahn jeder Zahnreihe die Nutenzeugung und ermöglicht somit den ersten Schritt des Verfahrens, das helikale Einfahren in die Vorbohrung.</p>	<p>Schritt 2: Gewindeformen</p> <p>Ist der Punch Tap auf Gewindetiefe angekommen, erfolgt das Gewindeformen, welches durch das synchrone Verfahren der Vorschubachse um die halbe Gewindesteigung bei gleichzeitiger Rotation des Werkzeuges um etwa 180° stattfindet.</p>	<p>Schritt 3: Herausfahren</p> <p>Nach der Ausführung des Gewindeformvorgangs wird der Punch Tap durch die erzeugten Nuten aus der Bohrung herausgefahren.</p> <p>Entstanden ist ein Gewinde mit zwei Helikalnuten.</p>
<p>Step 1: Punch (Plunge)</p> <p>The Punch Tap does not have a continuous thread profile on the circumference but two rows of teeth which are offset by 180°.</p> <p>The first tooth of each row of teeth is responsible for producing the groove and thereby enables the first step of the process, the helical plunge into the pre-drilled tap hole.</p>	<p>Step 2: Thread-forming</p> <p>Once the Punch Tap has reached the depth of the thread, the forming of the thread starts which is executed by a synchronous movement of the feed axis by half of the pitch while simultaneously rotating the tool by approximately 180°.</p>	<p>Step 3: Retraction</p> <p>Once the thread-forming process is finished, the Punch Tap is retracted from the hole through the generated grooves.</p> <p>The result is a thread with two helical grooves.</p>



EMUGE Punch Tap – der kurze Weg

Vergleicht man den Werkzeugweg des EMUGE Punch Tap mit dem Werkzeugweg herkömmlicher Gewindebohrer oder Gewindeformer, so fällt dieser bei einem Gewinde M6 mit 15 mm nutzbarer Gewindetiefe ca. 15 mal kürzer aus. Ergebnis ist eine deutliche Zeiteinsparung im Gewindezyklus von bis zu 75%.

EMUGE Punch Tap – the shortest way

When comparing the tool path of the EMUGE Punch Tap with the tool path of conventional taps or cold-forming taps, it shows that the path is approximately 15 times shorter for a thread M6 with a depth of thread of 15 mm. The result is a significant time savings up to 75% in a threading cycle.

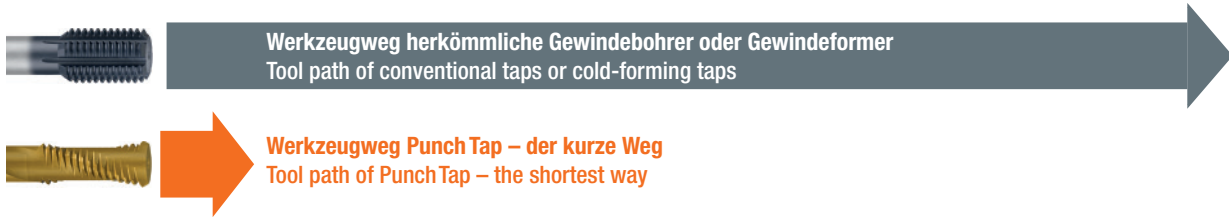

Untersuchungen am ISF der Universität Dortmund ergaben, dass das Punch Tap-Gewinde mit einem herkömmlich produzierten Gewinde in Eigenschaften und Ausreißfestigkeit vergleichbar ist.

Studies at the ISF at the University of Dortmund show that the thread produced by the Punch Tap is comparable with a conventionally produced thread in terms of properties and pull-out resistance.

Werkzeugwegvergleich

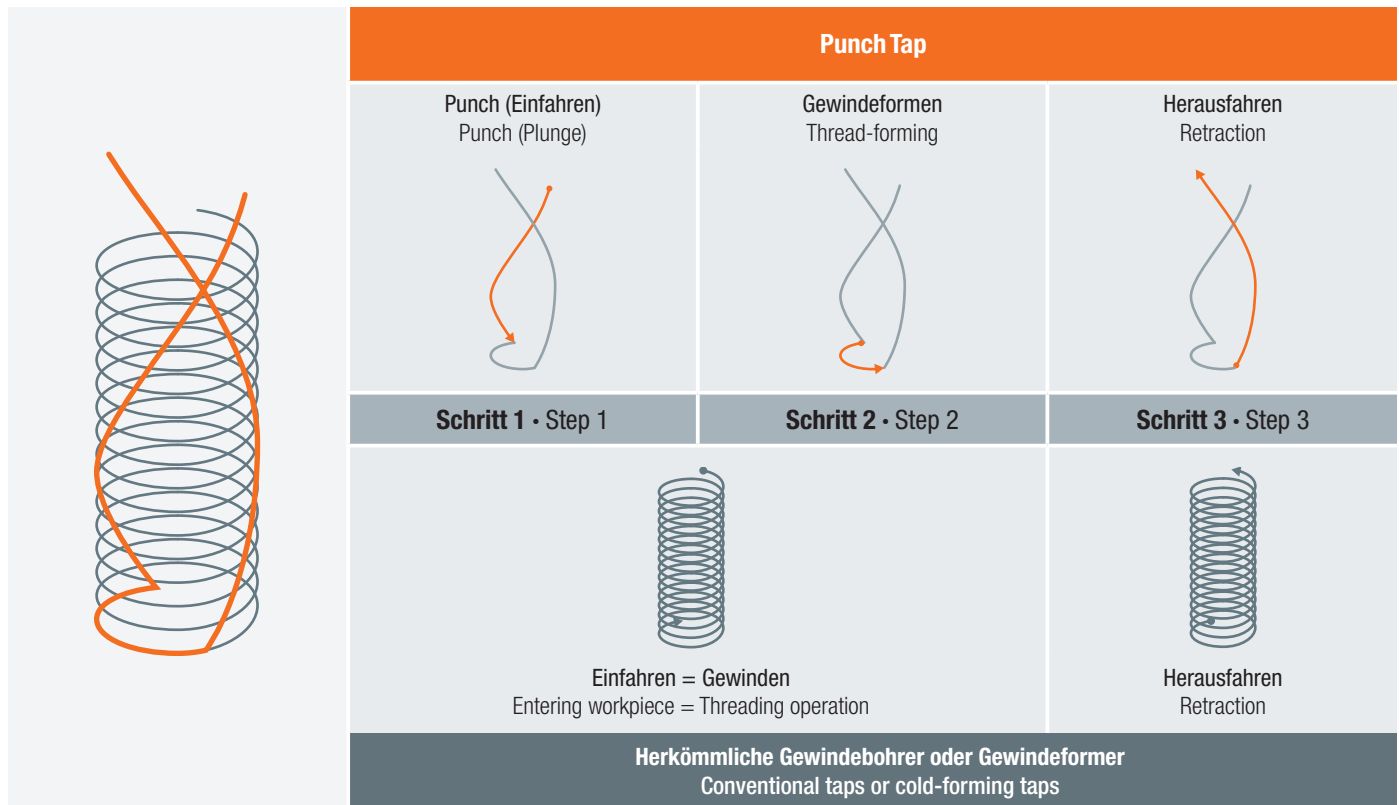

Comparison of tool paths



Die Möglichkeit eines Einsatzes der Punch Tap-Technologie hängt von den Prozessbedingungen ab und wird individuell ermittelt. Bei Interesse kontaktieren Sie uns bitte. Weitere Informationen finden Sie unter www.punchtap.com

The possibility of using the Punch Tap technology depends on the process conditions and is determined in each individual case. If interested, please contact us. For more information, see www.punchtap.com

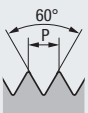
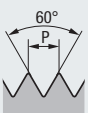
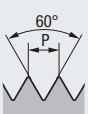
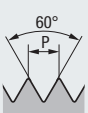
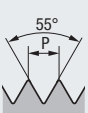

 <p>M</p>	<p>Metrisches ISO-Regelgewinde DIN 13</p>	<p>ISO Metric coarse thread DIN 13</p>
 <p>MF</p>	<p>Metrisches ISO-Feingewinde DIN 13</p>	<p>ISO Metric fine thread DIN 13</p>
 <p>UNC</p>	<p>Unified-Grobgewinde ASME B1.1</p>	<p>Unified coarse thread ASME B1.1</p>
 <p>UNF</p>	<p>Unified-Feingewinde ASME B1.1</p>	<p>Unified fine thread ASME B1.1</p>
 <p>UNEF</p>	<p>Unified-Extra-Feingewinde ASME B1.1</p>	<p>Unified extra fine thread ASME B1.1</p>
 <p>UN-8</p>	<p>Unified-Gewinde ASME B1.1 8-Gang-Reihe</p>	<p>Unified thread ASME B1.1 8-Thread series</p>
 <p>UNS</p>	<p>Unified-Gewinde ASME B1.1 Für spezielle Durchmesser und Steigungen</p>	<p>Unified thread ASME B1.1 For special diameters and pitches</p>
 <p>G (BSP)</p>	<p>Whitworth-Rohrgewinde DIN EN ISO 228 Für nicht im Gewinde dichtende Verbindungen</p>	<p>Whitworth pipe thread DIN EN ISO 228 where pressure-tight joints are not made on the threads</p>

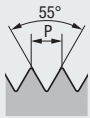

Rp (BSPP)

Zylindrisches Whitworth-Rohrgewinde
DIN EN 10226-1 und ISO 7-1

Innengewinde,
für im Gewinde dichtende Verbindungen

Cylindrical Whitworth pipe thread
DIN EN 10226-1 and ISO 7-1

Internal thread,
where pressure-tight joints are made on the threads

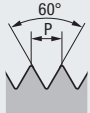

NPSM

Amerikanisches zylindrisches Rohrgewinde
ANSI B1.20.1

Mechanisches Rohrgewinde (früher NPS)

American Standard straight pipe thread
ANSI B1.20.1

For mechanical joints (previously NPS)



NPSF

Amerikanisches zylindrisches Rohrgewinde
ANSI B1.20.3

Zylindrisches Rohrdichtgewinde, gepaart mit kegeligem
Außengewinde NPTF oder PTF-SAE-SHORT;
Lehrung: konisch

American Standard straight pipe thread
ANSI B1.20.3

Dryseal internal straight pipe thread for fuel, combined with
external tapered pipe thread NPTF or PTF-SAE-SHORT;
Gauge with tapered gauges



NPT

Amerikanisches kegeliges Rohrgewinde
ANSI/ASME B1.20.1

Für Gewinde **mit Dichtmittel**, Kegel 1:16

American tapered pipe thread
ANSI/ASME B1.20.1

For threads **with sealant**, taper 1:16



NPTF

Amerikanisches kegeliges Rohrgewinde
ANSI B1.20.3

Für Gewinde **ohne Dichtmittel**, Kegel 1:16

American tapered pipe thread
ANSI B1.20.3

For threads **without sealant**, taper 1:16



R (BSPT)

Kegeliges Whitworth-Rohrgewinde
DIN EN 10226-1 und ISO 7-1

Außengewinde,
für im Gewinde dichtende Verbindungen,
Kegel 1:16

Tapered Whitworth pipe thread
DIN EN 10226-1 and ISO 7-1

External thread,
where pressure-tight joints are made on the threads,
taper 1:16



Rc (BSPT)

Kegeliges Whitworth-Rohrgewinde
DIN EN 10226-2 und ISO 7-1

Innengewinde,
für im Gewinde dichtende Verbindungen,
Kegel 1:16

Tapered Whitworth pipe thread
DIN EN 10226-2 and ISO 7-1

Internal thread,
where pressure-tight joints are made on the threads,
taper 1:16

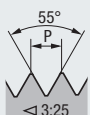

W keg
17E; 25E

Kegeliges Gewinde zur Verbindung
von Ventilen mit Gasflaschen
DIN EN ISO 11363, DIN 477-1

Kegel 3:25

Tapered thread for connection
of valves to gas cylinders
DIN EN ISO 11363, DIN 477-1

Taper 3:25

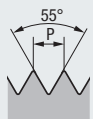
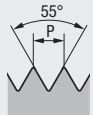
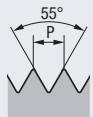
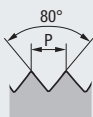
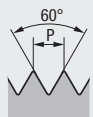
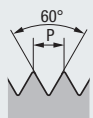
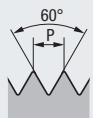
**W zyl****Zylindrisches Gewinde
für Gasflaschenventile
DIN 477-1****Cylindrical thread
for gas cylinder valves
DIN 477-1****BSW****Whitworth-Gewinde
BS 84****Whitworth thread
BS 84****BSF****Whitworth-Feingewinde
BS 84****Whitworth fine thread
BS 84****Pg****Stahlpanzerrohr-Gewinde
DIN 40430****Steel conduit thread
DIN 40430****MJ****MJ-Gewinde
DIN ISO 5855****MJ thread
DIN ISO 5855****UNJC****Unified-Grobgewinde
ASME B1.15****Unified coarse thread
ASME B1.15****UNJF****Unified-Feingewinde
ASME B1.15****Unified fine thread
ASME B1.15**

**EG M**

Metrisches ISO-Regelgewinde
DIN 8140-2

Für Gewindedrahteinsätze

ISO Metric coarse thread
DIN 8140-2

For wire thread inserts (STI)

**EG UNC**

Unified-Grobgewinde
ASME B18.29.1

Für Gewindedrahteinsätze

Unified coarse thread
ASME B18.29.1

For wire thread inserts (STI)

**EG UNF**

Unified-Feingewinde
ASME B18.29.1

Für Gewindedrahteinsätze

Unified fine thread
ASME B18.29.1

For wire thread inserts (STI)

**LK-M**

Metrisches SELF-LOCK-Regelgewinde
EMUGE-Norm

Metric SELF-LOCK coarse thread
EMUGE standard

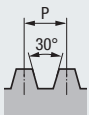
**Tr**

Metrisches ISO-Trapez-Regelgewinde
DIN 103

ISO Metric trapezoidal coarse thread
DIN 103

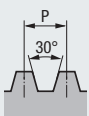
**Tr-F**

Metrisches ISO-Trapez-Feingewinde
DIN 103

ISO Metric trapezoidal fine thread
DIN 103

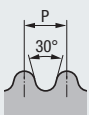
**Rd**

Rundgewinde
DIN 405

Round thread
DIN 405

1 Baumaße · Dimensions

2 Ausführung · Design

EMUGE Maschinen-Gewindebohrer · Machine Taps
Enorm 1

Product Finder

Vc

M

MF

UNC UN-8

UNF UNEF

G, Rp NPSM, NPSF

NPT, NPTF Rc, W

BSW, BSF

Pg

MJ UNJC, UNJF

EG (STI) SELF-LOCK

Tr, Tr-F Rd

Zubehör Accessories

Tech. Info

DIN 13

DIN 371

Toleranz - Tolerance
Beschichtung - Coating
Schneidstoff - Cutting material

Technische Informationen
Technical information

↪ 245 - 266

STEEL
Steel materials

7G	7G	ISO 2/6H	ISO 2/6H	ISO 2/6H
HSSE	HSSE	HSSE	HSSE	HSSE
R35	R35	LH, L35	LH, L35	R35
C/2-3	C/2-3	C/2-3	C/2-3	C/2-3
E/O	E/O	E/O	E/O	E/O

Gewindetiefe und Lochform
Thread depth and hole type

max. 2,5 x d₁

Einsatzgebiete - Material
Applications - material

↪ 22

P 1:1-3:1	P 1:1-4:1	P 1:1-3:1	P 1:1-4:1	P 1:1-3:1
N 2:2	K 2:1	N 2:2	K 2:1	N 2:2
	N 2:2		N 2:2	

Werkzeug-Ident - Tool ident

Ø d ₁ mm	P mm	l ₁	l ₂	l ₃	Ø d ₂	□	Dimens.- Ident	B0501031 Enorm 1-STEEL „7G“	B0501430 Enorm 1-STEEL TIN „7G“	B0501050 Enorm 1-STEEL-LH	B0501450 Enorm 1-STEEL-LH TIN	B0601000 Enorm 1-STEEL-X
M 1	0,25	40	5	-	2,5	2,1	.0010					
	1,1	0,25	40	5	-	2,5	2,1	.0011				
	1,2	0,25	40	5	-	2,5	2,1	.0012				
	1,4	0,3	40	6	-	2,5	2,1	.0014				
	1,6	0,35	40	6	11	2,5	2,1	.0016				
	1,7	0,35	40	6	11	2,5	2,1	.0017				
	1,8	0,35	40	6	11	2,5	2,1	.0018				
	2	0,4	45	7	12	2,8	2,1	.0020	●		○	
	2,2	0,45	45	7	12	2,8	2,1	.0022	●			
	2,3	0,4	45	7	12	2,8	2,1	.0023			○	
	2,5	0,45	50	9	14	2,8	2,1	.0025	●			
	2,6	0,45	50	9	14	2,8	2,1	.0026				
	3	0,5	56	11	18	3,5	2,7	.0030	●	●		●
	3,5	0,6	56	12	20	4	3	.0035				
	4	0,7	63	13	21	4,5	3,4	.0040	●			●
	4,5	0,75	70	14	25	6	4,9	.0045	●			●
	5	0,8	70	15	25	6	4,9	.0050	●			●
	5,5	0,9	80	16	30	6	4,9	.0055	●			●
	6	1	80	17	30	6	4,9	.0060	●			●
	7	1	80	17	30	7	5,5	.0070	●			●
	8	1,25	90	20	35	8	6,2	.0080	●			●
	9	1,25	90	20	35	9	7	.0090	●			●
	10	1,5	100	22	39	10	8	.0100	●			●
	12	1,75	120	25	47	12	10,2	.0112	●			●

● = Lagerwerkzeug, Preis siehe Preisliste
Stock tool, price see price list

Bei Bestellung bitten wir Sie, den **Dimensions-Ident** dem **Werkzeug-Ident** anzufügen.

Beispiel: **B0501430.0030**

In your order, please add to the **order ident** the **tool ident**.

Example: **B0501430.0030**



Gewindebohrer Taps

Seite · Page

Übersichten	Contents	16 - 21
Wegweiser und Schnittwerte	Product finder and cutting data	22 - 35
Produktseiten	Product pages	36 - 244
Technische Informationen	Technical information	245 - 266

Product Finder

Vc

M

MF

UNC
UN-8

UNF
UNEF

G, Rp
NPSM, NPSF

NPT, NPTF
Rc, W

BSW, BSF

Pg

MJ
UNJC, UNJF

EG (STI)
SELF-LOCK

Tr, Tr-F
Rd

Zubehör
Accessories

Tech. Info



Gewindebohrer mit verstärktem Schaft
Taps with reinforced shank

Rekord 1 Enorm 1

Gewindebohrer mit durchfallendem Schaft
Taps with reduced shank

Rekord 2 Enorm 2

Gewindebohrer mit Spanglocke
Taps with internal chip collector

Robust 2X

Gewindebohrer mit extra-langem Schaft
Taps with extra long shank

Rekord 1/2-LS Enorm 1/2-LS

Gewindebohrer mit langen Nuten und langem Schaft
Taps with long flutes and long shank

**Rekord 2-LF3
Rekord 2-LF4**

Seite · Page

M	36 - 61	64 - 83	84 - 85	62 - 63, 86 - 87	88 - 89
MF	102 - 107	108 - 125	126 - 127		128 - 129
UNC	140 - 143	144 - 147			
UNF	152 - 155	156 - 159			
UNEF		164 - 165			
UN-8		148			
G (BSP)	166 - 167	168 - 172	173		
Rp (BSPP)		179 - 180			
NPSM		182			
NPSF		183			
NPT	185 - 186	187 - 188			
NPTF	191	192			
Rc (BSPT)	195	196			
W					
BSW	201 - 202	203 - 204			
BSF	206	207			
Pg		209			
MJ	210 - 211				
UNJC	212 - 213				
UNJF	214 - 215				
EG M (STI)	216 - 217	218 - 219			
EG UNC (STI)	220 - 221	222 - 223			
EG UNF (STI)	224 - 225	226 - 227			
LK-M	228 - 229	230 - 231			
Tr					
Tr-F					
Rd					

Seite · Page

<p>Kegelreibahnen 1:16 für konische Gewinde Taper reamers 1:16 for tapered threads</p>	<p>200</p>
<p>Kühlschmierstoffe Coolant-lubricants</p>	<p>238 - 239</p>

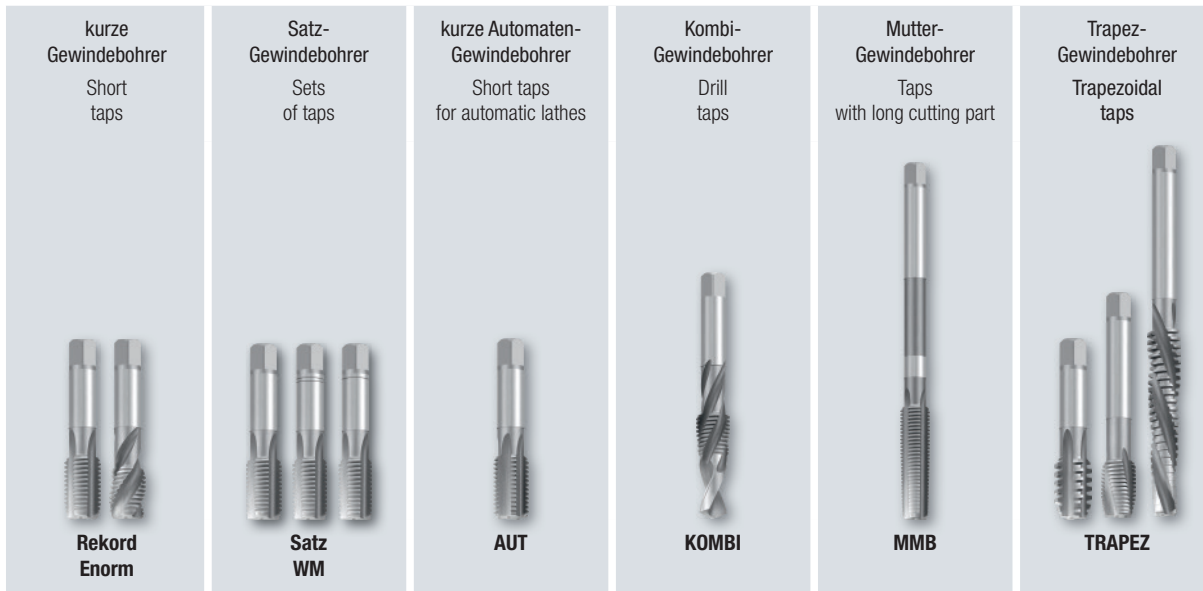

Seite · Page

90 - 91	92 - 99		100	101		M
130 - 131	132 - 137	138	139			MF
	149 - 151					UNC
160	161 - 163					UNF
						UNEF
						UN-8
174	175 - 177	178				G (BSP)
		181				Rp (BSPP)
						NPSM
						NPSF
189						NPT
193						NPTF
197						Rc (BSPT)
198 - 199						W
	205					BSW
	208					BSF
						Pg
						MJ
						UNJC
						UNJF
						EG M (STI)
						EG UNC (STI)
						EG UNF (STI)
						LK-M
					232 - 234	Tr
					235 - 236	Tr-F
237						Rd

- Product Finder**
- Vc
 - M
 - MF
 - UNC UN-8
 - UNF UNEF
 - G, Rp NPSM, NPSF
 - NPT, NPTF Rc, W
 - BSW, BSF
 - Pg
 - MJ UNJC, UNJF
 - EG (STI) SELF-LOCK
 - Tr, Tr-F Rd
 - Zubehör Accessories
 - Tech. Info



 <p>Spezial-Schaftverlängerungen Special shank extensions</p>	Seite · Page 240 - 242
 <p>Verstellbare Windeisen Adjustable tap wrenches</p>	243
 <p>Gewindebohrer-Auszieher Tap extractors</p>	244

- Product Finder
- V_c
- M
- MF
- UNC UN-8
- UNF UNEF
- G, Rp NPSM, NPSF
- NPT, NPTF Rc, W
- BSW, BSF
- Pg
- MJ UNJC, UNJF
- EG (STI) SELF-LOCK
- Tr, Tr-F Rd
- Zubehör Accessories
- Tech. Info

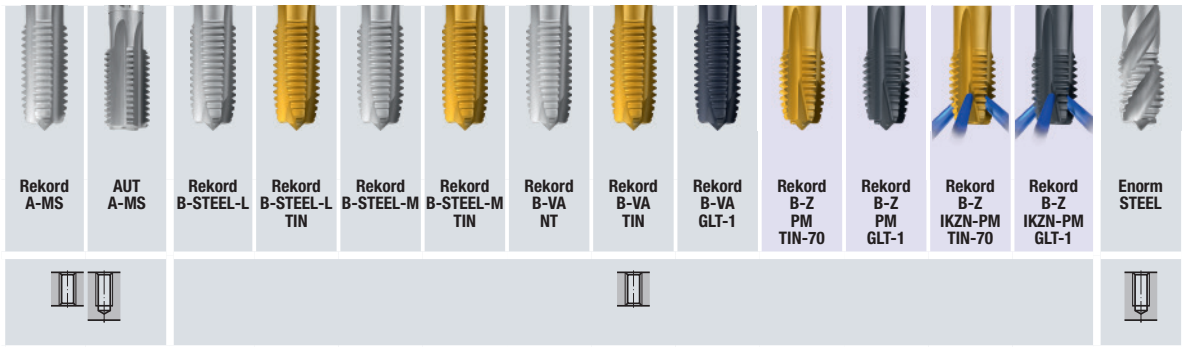

Seite · Page

M	ISO 1/4H			37 64	37 65			41 68	41 68	41 69					39 67
	ISO 3/6G			37 65	37 65	38	38	41 69	41 69	42 69					39 67
	6GX	91									55 77	55 77	55 77	55 77	
	7G			37 65	37 65	38	38	42 69	42 69	42 69					40 67
	6H +0,1														
MF	ISO 1/4H			108	108			115	115	116					103 113
	ISO 3/6G			110	110			116	116	116					
	6GX		138												
	6HX +0,1		138												
UNC	3B					140 144									141 145
	2B +0,05														
UNF	3B					152 156									153 157
	2B +0,05														
G (BSP)	+0,05														
	„X“ +0,05		178												
	„X“ +0,1		178												
Rp (BSPP)	„X“ +0,05		181												

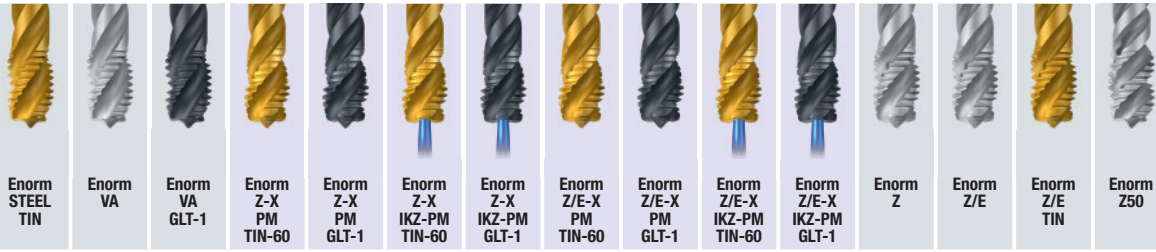

Seite · Page

39 67	43 70	43 70																ISO 1/4H	M
39 67	43 70	43 71												59 81	59 82			ISO 3/6G	
			57 79	57 79	57 80	57 80	57 80	57 80	57 80	58 81								6GX	
40 67	43 71	44 71																7G	
																	59 82	6H +0,1	MF
																		ISO 1/4H	
														107 124	107 125			ISO 3/6G	
																		6GX	
																		6HX +0,1	UNC
																		3B	
														143 147				2B +0,05	
																		3B	
																		3B	UNF
														155 159				2B +0,05	
														172				+0,05	
																		„X“ +0,05	
																		„X“ +0,1	G (BSP)
																		„X“ +0,05	
																		„X“ +0,05	Rp (BSPP)

Product
Finder

Vc

M

MF

UNC
UN-8

UNF
UNEF

G, Rp
NPSM, NPSF

NPT, NPTF
Rc, W

BSW, BSF

Pg

MJ
UNJC, UNJF

EG (STI)
SELF-LOCK

Tr, Tr-F
Rd

Zubehör
Accessories

Tech. Info



- Product Finder
- V_c
- M
- MF
- UNC UN-8
- UNF UNEF
- G, Rp NPSM, NPSF
- NPT, NPTF Rc, W
- BSW, BSF

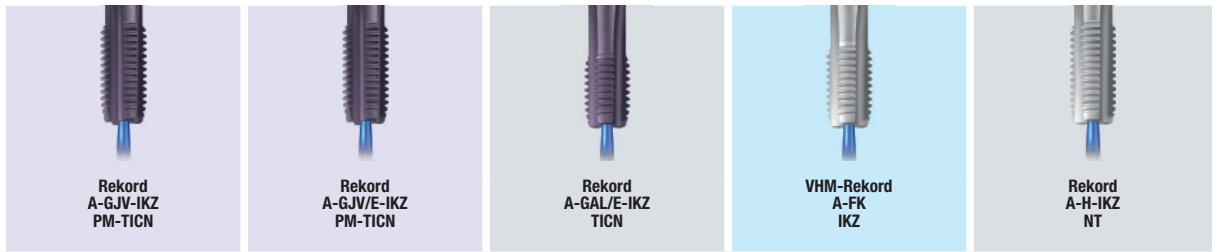
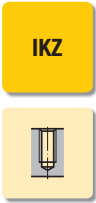

Seite · Page

M	45, 72	45, 72	47	47	50, 75
MF	117	117			119
G (BSP)					

- Pg
- MJ UNJC, UNJF
- EG (STI) SELF-LOCK
- Tr, Tr-F Rd
- Zubehör Accessories

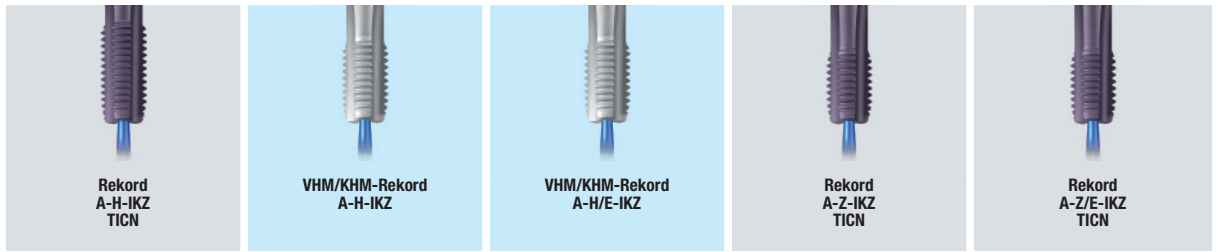
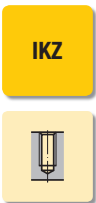

Seite · Page

M	50, 75	50, 75		53, 76, 88, 89	53, 76
MF	119	104, 119		119, 128, 129	120
G (BSP)			170		

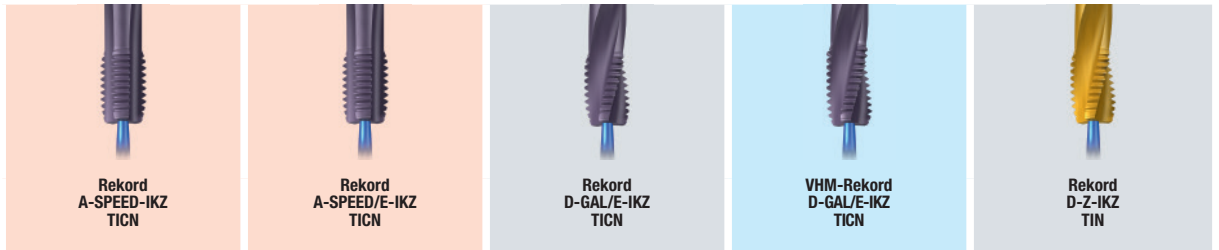
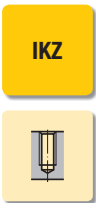

Seite · Page

M	60, 83	60, 83	47	47	55, 78, 88, 89
MF	125	125			121, 128, 129
G (BSP)					

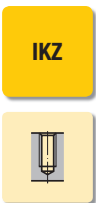

Seite · Page

M	55, 78	55, 63, 78, 87, 88, 89	55, 78	56, 57, 79, 80	56, 57, 79, 80
MF	121	121, 128, 129	121	122	122
G (BSP)				171	171

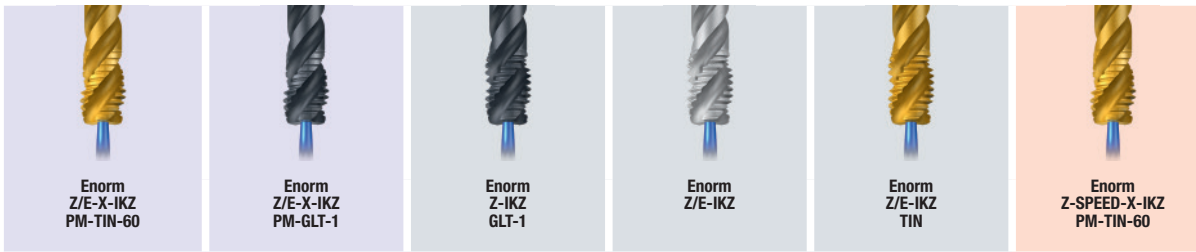

- Product Finder
- V_c
- M
- MF
- UNC UN-8
- UNF UNEF
- G, Rp NPSM, NPSF
- NPT, NPTF Rc, W
- BSW, BSF

Seite · Page

57, 79, 80	57, 58, 79, 81	58, 81	59	59, 81	61, 83	M
123	123		124	124	125	MF
171	171					G (BSP)



- Pg
- MJ UNJC, UNJF
- EG (ST) SELF-LOCK
- Tr, Tr-F Rd
- Zubehör Accessories

Seite · Page

45, 72	45, 73	47	50, 75	53, 76	54, 77	M
117	118		119	120	120	MF
						G (BSP)

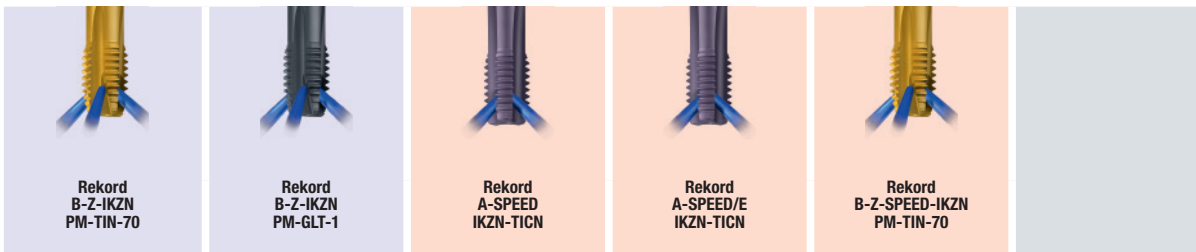

Seite · Page

54, 55, 77	54, 55, 77	60, 83	60, 83	61, 83		M
121	121	125	125	125		MF
						G (BSP)

- Product Finder
- V_c
- M
- MF
- UNC UN-8
- UNF UNEF
- G, Rp NPSM, NPSF
- NPT, NPTF Rc, W
- BSW, BSF
- Pg
- MJ UNJC, UNJF
- EG (STI) SELF-LOCK
- Tr, Tr-F Rd
- Zubehör Accessories
- Tech. Info

Wegweiser und Schnittwerte

Bitte beachten:

Die in den jeweiligen Spalten angegebenen Schnittgeschwindigkeiten (v_c in m/min) sind Richtwerte, welche je nach Einsatzbedingungen (Material, Schmierung, Maschine, usw.) angepasst werden müssen.

Die Eignung ist folgendermaßen gekennzeichnet:

- Gewindebohrer sehr gut geeignet
- Gewindebohrer gut geeignet

 = DIN-Form / Gänge (Anschnittlänge)

Internationaler Werkstoffvergleich siehe Seite 838 - 851.

Product finder and cutting data

Please note:

The cutting speeds (v_c in m/min) listed in the respective columns are standard values which have to be adjusted to individual work conditions (material, lubrication, machine etc.).

The suitability is marked as follows:

- Tap is very suitable
- Tap is suitable



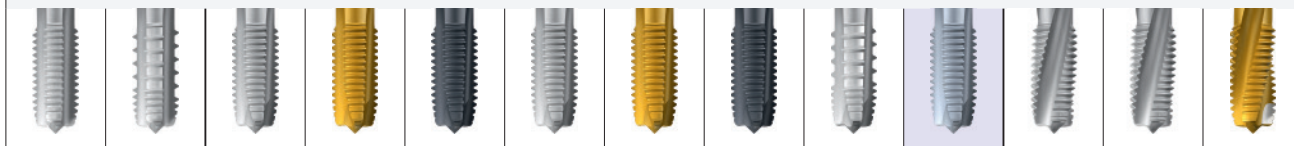

 = DIN form / threads (chamfer length)

International comparison of materials, see page 838 - 851.

		Einsatzgebiete – Material Applications – material		Material-Beispiele Material examples	Material-Nummern Material numbers
P	Stahlwerkstoffe Steel materials				
	1.1	Kaltfließpressstähle, Baustähle, Automatenstähle, u.a.	Cold-extrusion steels, Construction steels, Free-cutting steels, etc.	≤ 600 N/mm ²	Cq15 1.1132 S235JR (St37-2) 1.0037 10SPb20 1.0722
	2.1	Baustähle, Einsatzstähle, Stahlguss, u.a.	Construction steels, Cementation steels, Steel castings, etc.	≤ 800 N/mm ²	E360 (St70-2) 1.0070 16MnCr5 1.7131 GS-25CrMo4 1.7218
	3.1	Einsatzstähle, Vergütungsstähle, Kaltarbeitsstähle, u.a.	Cementation steels, Heat-treatable steels, Cold work steels, etc.	≤ 1000 N/mm ²	20MoCr3 1.7320 42CrMo4 1.7225 102Cr6 1.2067 50CrMo4 1.7228
	4.1	Vergütungsstähle, Kaltarbeitsstähle, Nitrierstähle, u.a.	Heat-treatable steels, Cold work steels, Nitriding steels, etc.	≤ 1200 N/mm ²	X45NiCrMo4 1.2767 31CrMo12 1.8515 X38CrMoV5-3 1.2367
	5.1	Hochlegierte Stähle, Kaltarbeitsstähle, Warmarbeitsstähle, u.a.	High-alloyed steels, Cold work steels, Hot work steels, etc.	≤ 1400 N/mm ²	X100CrMoV8-1-1 1.2990 X40CrMoV5-1 1.2344
M	Nichtrostende Stahlwerkstoffe Stainless steel materials				
	1.1	Ferritisch, martensitisch	Ferritic, martensitic	≤ 950 N/mm ²	X2CrTi12 1.4512
	2.1	Austenitisch	Austenitic	≤ 950 N/mm ²	X6CrNiMoTi17-12-2 1.4571
	3.1	Austenitisch-ferritisch (Duplex)	Austenitic-ferritic (Duplex)	≤ 1100 N/mm ²	X2CrNiMoN22-5-3 1.4462
	4.1	Austenitisch-ferritisch hitzebeständig (Super Duplex)	Austenitic-ferritic heat-resistant (Super Duplex)	≤ 1250 N/mm ²	X2CrNiMoN25-7-4 1.4410
K	Gusswerkstoffe Cast materials				
	1.1	Gusseisen mit Lamellengrafit (GJL)	Cast iron with lamellar graphite (GJL)	100-250 N/mm ²	EN-GJL-200 (GG20) EN-JL-1030
	1.2	Gusseisen mit Kugelgrafit (GJS)	Cast iron with nodular graphite (GJS)	250-450 N/mm ²	EN-GJL-300 (GG30) EN-JL-1050
	2.1	Gusseisen mit Kugelgrafit (GJS)	Cast iron with nodular graphite (GJS)	350-500 N/mm ²	EN-GJS-400-15 (GGG40) EN-JS-1030
	2.2	Gusseisen mit Kugelgrafit (GJS)	Cast iron with nodular graphite (GJS)	500-900 N/mm ²	EN-GJS-700-2 (GGG70) EN-JS-1070
	3.1	Gusseisen mit Vermiculargrafit (GJV)	Cast iron with vermicular graphite (GJV)	300-400 N/mm ²	GJV 300
	3.2	Gusseisen mit Vermiculargrafit (GJV)	Cast iron with vermicular graphite (GJV)	400-500 N/mm ²	GJV 450
4.1	Temperguss (GTMW, GTMB)	Malleable cast iron (GTMW, GTMB)	250-500 N/mm ²	EN-GJMW-350-4 (GTW-35) EN-JM-1010	
4.2	Temperguss (GTMW, GTMB)	Malleable cast iron (GTMW, GTMB)	500-800 N/mm ²	EN-GJMB-450-6 (GTS-45) EN-JM-1140	
N	Nichteisenwerkstoffe Non ferrous materials				
	Aluminium-Legierungen Aluminium alloys				
	1.1	Aluminium-Knetlegierungen	Aluminium wrought alloys	≤ 200 N/mm ²	EN AW-AlMn1 EN AW-3103
	1.2	Aluminium-Knetlegierungen	Aluminium wrought alloys	≤ 350 N/mm ²	EN AW-AlMgSi EN AW-6060
	1.3	Aluminium-Knetlegierungen	Aluminium wrought alloys	≤ 550 N/mm ²	EN AW-AlZn5Mg3Cu EN AW-7022
	1.4	Aluminium-Knetlegierungen	Aluminium wrought alloys	Si ≤ 7%	EN AC-AlMg5 EN AC-51300
	1.5	Aluminium-Gusslegierungen	Aluminium cast alloys	7% < Si ≤ 12%	EN AC-AISi9Cu3 EN AC-46500
	1.6	Aluminium-Gusslegierungen	Aluminium cast alloys	12% < Si ≤ 17%	GD-AISi17Cu4FeMg
	Kupfer-Legierungen Copper alloys				
	2.1	Reinkupfer, niedriglegiertes Kupfer	Pure copper, low-alloyed copper	≤ 400 N/mm ²	E-Cu 57 EN CW 004 A
	2.2	Kupfer-Zink-Legierungen (Messing, langspanend)	Copper-zinc alloys (brass, long-chipping)	≤ 550 N/mm ²	CuZn37 (Ms63) EN CW 508 L
	2.3	Kupfer-Zink-Legierungen (Messing, kurzspanend)	Copper-zinc alloys (brass, short-chipping)	≤ 550 N/mm ²	CuZn36Pb3 (Ms58) EN CW 603 N
	2.4	Kupfer-Aluminium-Legierungen (Alubronze, langspanend)	Copper-aluminium alloys (alu bronze, long-chipping)	≤ 800 N/mm ²	CuAl10Ni5Fe4 EN CW 307 G
	2.5	Kupfer-Zinn-Legierungen (Zinnbronze, langspanend)	Copper-tin alloys (tin bronze, long-chipping)	≤ 700 N/mm ²	CuSn8P EN CW 459 K
	2.6	Kupfer-Zinn-Legierungen (Zinnbronze, kurzspanend)	Copper-tin alloys (tin bronze, short-chipping)	≤ 400 N/mm ²	CuSn7 ZnPb (Rg7) 2.1090
	2.7	Kupfer-Sonderlegierungen	Special copper alloys	≤ 600 N/mm ²	(AMPCO® 8)
	2.8	Kupfer-Sonderlegierungen	Special copper alloys	≤ 1400 N/mm ²	(AMPCO® 45)
	Magnesium-Legierungen Magnesium alloys				
	3.1	Magnesium-Knetlegierungen	Magnesium wrought alloys	≤ 500 N/mm ²	MgAl6Zn 3.5612
	3.2	Magnesium-Gusslegierungen	Magnesium cast alloys	≤ 500 N/mm ²	EN-MCMgAl9Zn1 EN-MC21120
Kunststoffe Synthetics					
4.1	Duroplaste (kurzspanend)	Duroplastics (short-chipping)		Bakelit, Pertinax	
4.2	Thermoplaste (langspanend)	Thermoplastics (long-chipping)		PMMA, POM, PVC	
4.3	Faserverstärkte Kunststoffe (Faseranteil ≤ 30%)	Fibre-reinforced synthetics (fibre content ≤ 30%)		GFK, CFK, AFK	
4.4	Faserverstärkte Kunststoffe (Faseranteil > 30%)	Fibre-reinforced synthetics (fibre content > 30%)		GFK, CFK, AFK	
Besondere Werkstoffe Special materials					
5.1	Grafit	Graphite		C 8000	
5.2	Wolfram-Kupfer-Legierungen	Tungsten-copper alloys		W-Cu 80/20	
5.3	Verbundwerkstoffe	Composite materials		Hyllite, Alucobond	
S	Spezialwerkstoffe Special materials				
	Titan-Legierungen Titanium alloys				
	1.1	Reintitan	Pure titanium	≤ 450 N/mm ²	Ti1 3.7025
	1.2	Titan-Legierungen	Titanium alloys	≤ 900 N/mm ²	TiAl6V4 3.7165
	1.3	Titan-Legierungen	Titanium alloys	≤ 1250 N/mm ²	TiAl4Mo4Sn2 3.7185
	Nickel-, Kobalt- und Eisen-Legierungen Nickel alloys, cobalt alloys and iron alloys				
	2.1	Reinnickel	Pure nickel	≤ 600 N/mm ²	Ni 99.6 2.4060
	2.2	Nickel-Basis-Legierungen	Nickel-base alloys	≤ 1000 N/mm ²	Monel 400 2.4360
	2.3	Nickel-Basis-Legierungen	Nickel-base alloys	≤ 1600 N/mm ²	Inconel 718 2.4668
	2.4	Nickel-Basis-Legierungen	Nickel-base alloys	≤ 1000 N/mm ²	Udimet 605
	2.5	Kobalt-Basis-Legierungen	Cobalt-base alloys	≤ 1600 N/mm ²	Haynes 25 2.4964
	2.6	Eisen-Basis-Legierungen	Iron-base alloys	≤ 1500 N/mm ²	Incoloy 800 1.4958
H	Harte Werkstoffe Hard materials				
	1.1	Hochfeste Stähle, gehärtete Stähle, Hartguss	High strength steels, hardened steels, hard castings	44 - 50 HRC	Weldox 1100
	1.2	Hochfeste Stähle, gehärtete Stähle, Hartguss	High strength steels, hardened steels, hard castings	50 - 55 HRC	Hardox 550
	1.3	Hochfeste Stähle, gehärtete Stähle, Hartguss	High strength steels, hardened steels, hard castings	55 - 60 HRC	Armax 600T
	1.4	Hochfeste Stähle, gehärtete Stähle, Hartguss	High strength steels, hardened steels, hard castings	60 - 63 HRC	Ferro-Titanit
	1.5	Hochfeste Stähle, gehärtete Stähle, Hartguss	High strength steels, hardened steels, hard castings	63 - 66 HRC	HSSE



Rekord A-STEEL	Rekord A-STEEL-AZ	Rekord B-STEEL-L	Rekord B-STEEL-L TIN	Rekord B-STEEL-L GLT-1	Rekord B-STEEL-M	Rekord B-STEEL-M TIN	Rekord B-STEEL-M GLT-1	Rekord B-STEEL-M AZ	Rekord B-STEEL-H PM-CRT	Rekord D-STEEL	Rekord D-STEEL/E	Rekord DF-STEEL TIN
C / 2-3	C / 2-3	B / 4-5	B / 4-5	B / 4-5	B / 4-5	B / 4-5	B / 4-5	B / 4-5	B ≈ 6	C / 2-3	E / 1,5-2	C / 2-3

max. 2 x d ₁ 		max. 3 x d ₁ 							max. 2 x d ₁ 			Gewindetiefe und Lochform Thread depth and hole type 
--	--	--	--	--	--	--	--	--	--	--	--	--

36, 64, 90 102, 108, 130	36, 64, 90	36, 64 102, 108 140, 144 152, 156	36, 64 102, 108	36	37, 62, 65, 86, 90 111 140, 144 152, 156 164 168	37, 65 111	38	90	39, 65 102, 111	39, 66, 91 111	39, 62, 66, 86 111	39, 62, 66, 86
-----------------------------	------------	--	--------------------	----	---	---------------	----	----	--------------------	-------------------	-----------------------	----------------

- UNC
- UN-8
- UNEF
- M
- MF
- G, Rp
- NPSM, NPSF
- NPT, NPTF
- Rc, W
- BSW, BSF
- Pg
- MJ
- UNJC, UNJF
- EG (STI)
- LK-M
- Tr, Tr-F, Rd

Seite · Page

5 - 25	5 - 25	5 - 25	15 - 45	15 - 45									15 - 45	1.1
5 - 20	5 - 20	5 - 20	10 - 40	10 - 40	5 - 20	10 - 40	10 - 40	5 - 20		5 - 20	5 - 20	10 - 40		2.1
2 - 15	2 - 15	2 - 15	5 - 25	5 - 25	2 - 15	5 - 25	5 - 25	2 - 15	10 - 40	2 - 15	2 - 15	5 - 25		3.1
			5 - 20	5 - 20	2 - 10	5 - 20	5 - 20	2 - 10	5 - 25				5 - 20	4.1
									5 - 20					5.1
														1.1
														2.1
													15 - 45	3.1
													10 - 40	4.1
													10 - 30	1.1
													10 - 40	1.2
													10 - 30	2.1
													10 - 25	2.2
													10 - 25	3.1
													10 - 20	3.2
													15 - 45	4.1
													10 - 40	4.2
														1.1
														1.2
														1.3
													15 - 40	1.4
													15 - 40	1.5
														1.6
														2.1
														2.2
														2.3
														2.4
														2.5
														2.6
														2.7
														2.8
														3.1
														3.2
														4.1
														4.2
														4.3
														4.4
														5.1
														5.2
														5.3
														1.1
														1.2
														1.3
														2.1
														2.2
														2.3
														2.4
														2.5
														2.6
														1.1
														1.2
														1.3
														1.4
														1.5

- Product Finder
- V_c
- M
- MF
- UNC
- UN-8
- UNEF
- G, Rp
- NPSM, NPSF
- NPT, NPTF
- Rc, W
- BSW, BSF
- Pg
- MJ
- UNJC, UNJF
- EG (STI)
- SELF-LOCK
- Tr, Tr-F, Rd
- Zubehör
- Accessories
- Tech. Info



Product Finder

V_c

M

MF

UNC UN-8

UNF UNEF

G, Rp NPSM, NPSF

NPT, NPTF Rc, W

BSW, BSF

Pg

MJ UNJC, UNJF

EG (STI) SELF-LOCK

Tr, Tr-F Rd

Zubehör Accessories

Tech. Info



	Enorm STEEL	Enorm STEEL TIN	Enorm STEEL-X	Enorm STEEL-X TIN	Rekord B-VA NT	Rekord B-VA TIN	Rekord B-VA GLT-1	Rekord B-VA-AZ NT	Enorm VA	Enorm VA GLT-1	Enorm VA-X	Enorm VA-X GLT-1
	C / 2-3	C / 2-3	C / 2-3	C / 2-3	B / 4-5	B / 4-5	B / 4-5	B / 4-5	C / 2-3	C / 2-3	C / 2-3	C / 2-3

Gewindetiefe und Lochform Thread depth and hole type	max. 2,5 x d ₁				max. 3 x d ₁				max. 2,5 x d ₁			

M	39, 62, 66, 86, 91	39, 66	40, 67	41, 67	41, 63, 68, 87, 91	41, 68	41, 63, 68, 87	43	43, 63, 70, 87	43, 63, 70, 87	44, 71	44, 71
MF	103, 113	103, 113			115	103, 115	103, 115		103, 116	103, 117		
UNC	140, 144	140, 144			141, 145	141, 145	141, 145		141, 145	141, 145		
UNF	152, 156	152, 156			153, 157	153, 157	153, 157		153, 157	153, 157		
UNEF, UN-8	164				165	165	165		148			
G, Rp	169	169			169	169	169		169	170		
NPSM, NPSF												
NPT, NPTF, Rc, W												
BSW, BSF	201, 203				201, 203	201, 203	201, 203		202, 204	202, 204		
Pg												
MJ												
UNJC, UNJF												
EG (STI)					216 - 226	216 - 226	216 - 226					
LK-M					228, 230	228, 230	228, 230					
Tr, Tr-F, Rd												

P	1.1	5 - 25	15 - 45	5 - 25	15 - 45	5 - 25	15 - 45	15 - 45	5 - 25	5 - 25	15 - 45	5 - 25	15 - 45
	2.1	5 - 20	10 - 40	5 - 20	10 - 40	5 - 20	10 - 40	10 - 40	5 - 20	5 - 20	10 - 40	5 - 20	10 - 40
	3.1	2 - 15	5 - 25	2 - 15	5 - 25	2 - 15	5 - 25	5 - 25	2 - 15	2 - 15	5 - 25	2 - 15	5 - 25
	4.1		5 - 20		5 - 20		5 - 20	5 - 20			5 - 20		5 - 20
	5.1												

M	1.1												
	2.1					2 - 10	5 - 20	5 - 20	2 - 10	2 - 10	5 - 20	2 - 10	5 - 20
	3.1					2 - 10	5 - 20	5 - 20	2 - 10	2 - 10	5 - 20	2 - 10	5 - 20
	4.1						5 - 15	5 - 15			5 - 15		5 - 15

K	1.1												
	1.2												
	2.1		10 - 30		10 - 30	5 - 20	10 - 30	10 - 30	5 - 20	5 - 20	10 - 30	5 - 20	10 - 30
	2.2												
	3.1												
	3.2												
	4.1												
	4.2												

N	1.1												
	1.2												
	1.3												
	1.4												
	1.5												
	1.6												
	2.1												
	2.2	10 - 40	20 - 60	10 - 40	20 - 60	10 - 40	20 - 60	20 - 60	10 - 40				

N	2.3												
	2.4												
	2.5					2 - 10	5 - 25		2 - 10				
	2.6					2 - 10	5 - 25		2 - 10				
	2.7												
	2.8												
	3.1												
	3.2												

N	4.1												
	4.2												
	4.3												
	4.4												
	5.1												

N	5.2												
	5.3												
	1.1												
	1.2												
	1.3												
	2.1												

S	2.2												
	2.3												
	2.4												
	2.5												
	2.6												

H	1.1												
	1.2												
	1.3												
	1.4												
	1.5												

EMUGE
VA

EMUGE
GG

EMUGE
GJV



Robust
2X-VA
NE2
C / 2-3

Robust
2X-VA
TIN
C / 2-3

Rekord
A-GG
NT
C / 2-3

Rekord
A-GG
TICN
C / 2-3

Rekord
A-GJV
PM-TICN
C / 2-3

Rekord
A-GJV-1KZ
PM-TICN
C / 2-3

Rekord
A-GJV-1KZN
PM-TICN
C / 2-3

Rekord
A-GJV/E
PM-TICN
E / 1,5-2

Rekord
A-GJV/E-1KZ
PM-TICN
E / 1,5-2

Rekord
A-GJV/E-1KZN
PM-TICN
E / 1,5-2



Gewindetiefe und Lochform
Thread depth and hole type

84
126

173

85
126

173

45, 71
117

45, 71
117

45, 72
117

45, 72
117

45, 72
117

45, 72
117

45, 72
117

45, 73
118

Seite . Page

2 - 8

2 - 8

1.1

2 - 6

2 - 6

2.1

1 - 8

1 - 8

3.1

1 - 5

1 - 5

4.1

5.1

1 - 8

1 - 8

1.1

1 - 8

1 - 8

2.1

3.1

4.1

2 - 10

2 - 10

10 - 25

15 - 45

15 - 45

15 - 45

15 - 45

15 - 45

15 - 45

15 - 45

1.1

2 - 10

2 - 10

10 - 20

10 - 40

10 - 40

10 - 40

10 - 40

10 - 40

10 - 40

10 - 40

1.2

2 - 8

2 - 8

10 - 30

10 - 30

10 - 30

10 - 30

10 - 30

10 - 30

2.1

2 - 8

2 - 8

10 - 25

10 - 25

10 - 25

10 - 25

10 - 25

10 - 25

2.2

2 - 8

2 - 8

10 - 25

10 - 25

10 - 25

10 - 25

10 - 25

10 - 25

3.1

2 - 8

2 - 8

10 - 20

10 - 20

10 - 20

10 - 20

10 - 20

10 - 20

3.2

2 - 10

2 - 10

15 - 45

15 - 45

15 - 45

15 - 45

15 - 45

15 - 45

4.1

2 - 10

2 - 10

10 - 40

10 - 40

10 - 40

10 - 40

10 - 40

10 - 40

4.2

1.1

1.2

1.3

1.4

1.5

1.6

2.1

2.2

2.3

2.4

2.5

2.6

2.7

2.8

3.1

3.2

4.1

4.2

4.3

4.4

5.1

5.2

5.3

1.1

1.2

1.3

2.1

2.2

2.3

2.4

2.5

2.6

1.1

1.2

1.3

1.4

1.5

Product Finder

Vc

M

MF

UNC UN-8

UNEF

G, Rp

NPT, NPTF Rc, W

BSW, BSF

Pg

MJ

EG (ST) SELF-LOCK

Tr, Tr-F Rd

Zubehör Accessories

Tech. Info



- Product Finder
- V_c
- M
- MF
- UNC UN-8
- UNF UNEF
- G, Rp NPSM, NPSF
- NPT, NPTF Rc, W
- BSW, BSF
- Pg
- MJ UNJC, UNJF
- EG (STI) SELF-LOCK
- Tr, Tr-F Rd
- Zubehör Accessories
- Tech. Info

EMUGE
AL

EMUGE
GAL

EMUGE
MG



	Rekord B-AL	Rekord B-AL GLT-8	Enorm AL	Enorm AL GLT-8	Enorm AL/E GLT-8	Rekord A-GAL/E IKZ-TICN	Rekord A-GAL/E IKZN-TICN	Rekord D-GAL/E IKZ-TICN	VHM-Rekord D-GAL/E IKZ-TICN	Rekord A-MG GLT-1
	B / ≈3	B / ≈3	C / 2-3	C / 2-3	E / 1,5-2	E / 1,5-2	E / 1,5-2	E / 1,5-2	E / 1,5-2	C / 2-3
Gewindetiefe und Lochform Thread depth and hole type	max. 3 x d ₁ 		max. 2,5 x d ₁ 			max. 2 x d ₁ 		max. 2 x d ₁ 		max. 2 x d ₁
M	46, 73	46, 73	46, 73	46, 73	46	47	47	47	47	47
MF			118							
UNC										
UNF										
UNEF										
G, Rp										
NPSM, NPSF										
NPT, NPTF										
Rc, W										
BSW, BSF										
Pg				210						
MJ				212, 214						
UNJC, UNJF				217 - 225						
EG (STI)	217	217		229						
LK-M										
Tr, Tr-F, Rd										
P	1.1									
	2.1									
	3.1									
	4.1									
	5.1									
M	1.1									
	2.1									
	3.1									
	4.1									
K	1.1									
	1.2									
	2.1									
	2.2									
	3.1									
	3.2									
	4.1									
	4.2									
N	1.1	10 - 20	15 - 40	10 - 20	15 - 40	15 - 40				
	1.2	10 - 20	15 - 40	10 - 20	15 - 40	15 - 40				
	1.3	10 - 20	15 - 40	10 - 20	15 - 40	15 - 40				
	1.4	10 - 20	15 - 40	10 - 20	15 - 40	15 - 40	15 - 40	15 - 40	15 - 40	40 - 80
	1.5						15 - 40	15 - 40	15 - 40	40 - 80
	1.6						10 - 30	10 - 30	10 - 30	30 - 60
	2.1									
	2.2									
	2.3									
	2.4									
	2.5									
	2.6									
	2.7									
	2.8									
	3.1									20 - 60
	3.2									20 - 60
4.1										
4.2										
4.3										
4.4										
5.1										
5.2										
5.3										
S	1.1									
	1.2									
	1.3									
	2.1									
	2.2									
	2.6									
H	1.1									
	1.2									
	1.3									
	1.4									
	1.5									

1) Gewindebohren in Durchgangslöcher nur mit externer Kühlschmierung möglich
Threading in through holes is possible only with external cooling/lubrication

EMUGE FK		EMUGE PVC		EMUGE MS		EMUGE TI				EMUGE TILEG	
Rekord A-FK NT	VHM-Rekord A-FK-1KZ	Rekord D-PVC/E CRN	Rekord A-MS	Rekord C-TI NT2	Rekord C-TI TICN	Rekord D-TI NT2	Rekord D-TI TICN	Rekord DF-TILEG TICN			
C / 2-3	C / 2-3	E / 1,5-2	C / 2-3	D / 4-5	D / 4-5	C / 2-3	C / 2-3	C / 2-3			
max. 2 x d ₁ 	max. 2 x d ₁ 	max. 2 x d ₁ 	max. 2 x d ₁ 	max. 3 x d ₁ 		max. 2 x d ₁ 		max. 2 x d ₁ 			Gewindetiefe und Lochform Thread depth and hole type
47	47	48	48, 91	48, 73	49, 73	49, 73	49, 74	49			
											M MF UNC UNF G, Rp NPSM, NPSF NPT, NPTF Rc, W BSW, BSF Pg MJ UNJC, UNJF EG (ST) LK-M Tr, Tr-F, Rd
											1.1
											2.1
											3.1
											4.1
											5.1
											1.1
											2.1
											3.1
											4.1
											1.1
											2.1
											3.1
											4.1
											5.1
											1.1
											2.1
											3.1
											4.1
											5.1
											1.1
											2.1
											3.1
											4.1
											5.1
											1.1
											2.1
											3.1
											4.1
											5.1
											1.1
											2.1
											3.1
											4.1
											5.1
											1.1
											2.1
											3.1
											4.1
											5.1
											1.1
											2.1
											3.1
											4.1
											5.1
											1.1
											2.1
											3.1
											4.1
											5.1
											1.1
											2.1
											3.1
											4.1
											5.1
											1.1
											2.1
											3.1
											4.1
											5.1
											1.1
											2.1
											3.1
											4.1
											5.1
											1.1
											2.1
											3.1
											4.1
											5.1

Product Finder

V_c

M

MF

UNC UN-8

UNEF

G, Rp NPSM, NPSF

NPT, NPTF Rc, W

BSW, BSF

Pg

MJ UNJC, UNJF

EG (ST) SELF-LOCK

Tr, Tr-F Rd

Zubehör Accessories

Tech. Info



Product Finder

V_c

M

MF

UNC UN-8
Gewindetiefe und Lochform
Thread depth and hole type

UNF UNEF

G, Rp
NPSM, NPSF

NPT, NPTF
Rc, W

BSW, BSF

Pg

MJ
UNJC, UNJF
EG (STI)
LK-M
Tr, Tr-F, Rd

EG (STI)
SELF-LOCK

Tr, Tr-F
Rd







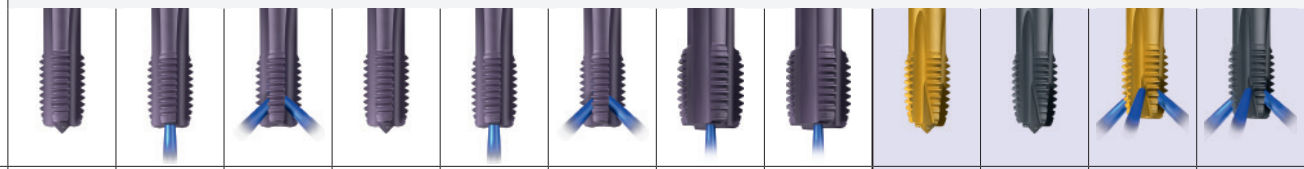

Zubehör
Accessories

Tech. Info



	Rekord C-NI-PM TiCN	Rekord DF-NI-PM TiCN	Rekord A-H NT	Rekord A-H TiCN	Rekord A-H-IKZ NT	Rekord A-H-IKZ TiCN	Rekord A-H-IKZN TiCN	VHM/KHM Rekord A-H-IKZ	VHM/KHM Rekord A-H/E-IKZ	Rekord A-HCUT-PM TiCN	VHM-Rekord A-HCUT/D TiCN	VHM-Rekord A-HCUT/C TiCN 3)
	D / 4-5	C / 2-3	C / 2-3	C / 2-3	C / 2-3	C / 2-3	C / 2-3	C / 2-3	E / 1,5-2	C / 2-3	D / 4-5	C / 2-3
	max. 3 x d ₁	max. 2 x d ₁	max. 2 x d ₁		max. 2 x d ₁		max. 2 x d ₁	max. 2 x d ₁		max. 1,5 x d ₁		max. 1,5 x d ₁
M	49, 74	49, 74	49, 63, 75, 87	50, 75	50, 75	50, 75	50, 75	50, 75	104, 119	51, 75	52	52
MF			104, 118	119	119	119	119			104, 119	105	105
UNC UN-8			141, 145									
UNF UNEF			153, 157									
G, Rp				170	170							
NPSM, NPSF												
NPT, NPTF												
Rc, W												
BSW, BSF												
Pg			209									
MJ	211	211										
UNJC, UNJF	213, 215	213, 215										
EG (STI)												
LK-M												
Tr, Tr-F, Rd												
P	1.1		5 - 25	15 - 45	5 - 25	15 - 45	15 - 45					
	2.1		5 - 20	10 - 40	5 - 20	10 - 40	10 - 40					
	3.1		2 - 15	5 - 25	2 - 15	5 - 25	5 - 25					
	4.1			5 - 20		5 - 20	5 - 20					
	5.1							5 - 15	5 - 15			
M	1.1											
	2.1											
	3.1											
	4.1	2 - 10	2 - 10									
K	1.1		10 - 25	15 - 45	10 - 25	15 - 45	15 - 45	40 - 80	40 - 80			
	1.2		10 - 20	10 - 40	10 - 20	10 - 40	10 - 40	30 - 60	30 - 60			
	2.1		5 - 20	10 - 30	5 - 20	10 - 30	10 - 30	30 - 60	30 - 60			
	2.2		5 - 15	10 - 25	5 - 15	10 - 25	10 - 25	20 - 40	20 - 40			
	3.1		5 - 15	10 - 25	5 - 15	10 - 25	10 - 25	20 - 40	20 - 40			
	3.2		5 - 10	10 - 20	5 - 10	10 - 20	10 - 20	20 - 40	20 - 40			
	4.1		10 - 25	15 - 45	10 - 25	15 - 45	15 - 45	40 - 80	40 - 80			
4.2		10 - 20	10 - 40	10 - 20	10 - 40	10 - 40	30 - 60	30 - 60				
N	1.1											
	1.2											
	1.3											
	1.4											
	1.5							20 - 60	20 - 60			
	1.6							20 - 40	20 - 40			
	2.1											
	2.2											
	2.3											
	2.4			2 - 10	5 - 25	2 - 10	5 - 25	5 - 25				
	2.5			2 - 10	5 - 25	2 - 10	5 - 25	5 - 25				
	2.6			5 - 20	10 - 30	5 - 20	10 - 30	10 - 30	20 - 40	20 - 40		
	2.7			1 - 5	2 - 10	1 - 5	2 - 10	2 - 10	5 - 15	5 - 15		
2.8	1 - 5	1 - 5						1 - 8	1 - 8			
3.1												
3.2												
4.1			5 - 25	10 - 40	5 - 25	10 - 40	10 - 40	20 - 60	20 - 60			
4.2												
4.3												
4.4								10 - 25	10 - 25			
5.1			10 - 20	10 - 20	10 - 20	10 - 20	10 - 20	20 - 60	20 - 60			
5.2								10 - 30	10 - 30			
5.3												
S	1.1											
	1.2	2 - 10	2 - 10									
	1.3	1 - 8	1 - 8									
	2.1											
	2.2											
	2.3	1 - 8	1 - 8									
2.4												
2.5	1 - 8	1 - 8										
2.6	1 - 8	1 - 8										
H	1.1							1 - 5	1 - 5	1 - 5		
	1.2							1 - 3	1 - 3	1 - 3		
	1.3										1 - 3	1 - 3
	1.4										1 - 2	1 - 2
	1.5											



Rekord A-Z TICN	Rekord A-Z-IKZ TICN	Rekord A-Z-IKZN TICN	Rekord A-Z/E TICN	Rekord A-Z/E-IKZ TICN	Rekord A-Z/E-IKZN TICN	Rekord A-Z-IKZ-LF3 TICN	Rekord A-Z-IKZ-LF4 TICN	Rekord B-Z-PM TIN-70	Rekord B-Z-PM GLT-1	Rekord B-Z-IKZN PM-TIN-70	Rekord B-Z-IKZN PM-GLT-1	
C / 2-3	C / 2-3	C / 2-3	E / 1,5-2	E / 1,5-2	E / 1,5-2	C / 2-3	C / 2-3	B / 4-5	B / 4-5	B / 4-5	B / 4-5	
max. 2 x d ₁	max. 2 x d ₁	max. 2 x d ₁	max. 2 x d ₁	max. 2 x d ₁	max. 2 x d ₁	max. 3 x d ₁	max. 4 x d ₁	max. 3 x d ₁				Gewindetiefe und Lochform Thread depth and hole type
												
53,76 119	53,76 119	53,76 120	53,76 120	53,76 120	54,77 120	88 128	89 129	54,77 106, 121	54,77 106, 121	54,77 121	54,77 121	

 Gewindetiefe und Lochform
 Thread depth and hole type
 M
 MF
 UNF
 G, Rp
 NPSM, NPSF
 UNEF, UN-8
 G, Rp
 NPT, NPTF
 Rc, W
 NPT, NPTF, Rc
 W
 BSW, BSF
 Pg
 MJ
 UNJC, UNJF
 EG (ST)
 LK-M
 Tr, Tr-F, Rd

Seite . Page

15 - 45	15 - 45	15 - 45	15 - 45	15 - 45	15 - 45	15 - 45	15 - 45	15 - 45	15 - 45	15 - 45	15 - 45	15 - 45	1.1
10 - 40	10 - 40	10 - 40	10 - 40	10 - 40	10 - 40	10 - 40	10 - 40	10 - 40	10 - 40	10 - 40	10 - 40	10 - 40	2.1
5 - 25	5 - 25	5 - 25	5 - 25	5 - 25	5 - 25	5 - 25	5 - 25	5 - 25	5 - 25	5 - 25	5 - 25	5 - 25	3.1
5 - 20	5 - 20	5 - 20	5 - 20	5 - 20	5 - 20	5 - 20	5 - 20	5 - 20	5 - 20	5 - 20	5 - 20	5 - 20	4.1
									2 - 15	2 - 15	2 - 15	2 - 15	5.1
									5 - 20	5 - 20	5 - 20	5 - 20	1.1
									5 - 20	5 - 20	5 - 20	5 - 20	2.1
									5 - 15	5 - 15	5 - 15	5 - 15	3.1
													4.1
15 - 45	15 - 45	15 - 45	15 - 45	15 - 45	15 - 45	15 - 45	15 - 45						1.1
10 - 40	10 - 40	10 - 40	10 - 40	10 - 40	10 - 40	10 - 40	10 - 40						1.2
10 - 30	10 - 30	10 - 30	10 - 30	10 - 30	10 - 30	10 - 30	10 - 30	10 - 30	10 - 30	10 - 30	10 - 30	10 - 30	2.1
10 - 25	10 - 25	10 - 25	10 - 25	10 - 25	10 - 25	10 - 25	10 - 25						2.2
10 - 25	10 - 25	10 - 25	10 - 25	10 - 25	10 - 25	10 - 25	10 - 25						3.1
10 - 20	10 - 20	10 - 20	10 - 20	10 - 20	10 - 20	10 - 20	10 - 20						3.2
15 - 45	15 - 45	15 - 45	15 - 45	15 - 45	15 - 45	15 - 45	15 - 45						4.1
10 - 40	10 - 40	10 - 40	10 - 40	10 - 40	10 - 40	10 - 40	10 - 40						4.2
													1.1
													1.2
													1.3
15 - 40	15 - 40	15 - 40	15 - 40	15 - 40	15 - 40	15 - 40	15 - 40	15 - 40	15 - 40	15 - 40	15 - 40	15 - 40	1.4
15 - 40	15 - 40	15 - 40	15 - 40	15 - 40	15 - 40	15 - 40	15 - 40	15 - 40	15 - 40	15 - 40	15 - 40	15 - 40	1.5
10 - 30	10 - 30	10 - 30	10 - 30	10 - 30	10 - 30	10 - 30	10 - 30	10 - 30	10 - 30	10 - 30	10 - 30	10 - 30	1.6
								5 - 30	5 - 30	5 - 30	5 - 30	5 - 30	2.1
								20 - 60	20 - 60	20 - 60	20 - 60	20 - 60	2.2
													2.3
5 - 25	5 - 25	5 - 25	5 - 25	5 - 25	5 - 25	5 - 25	5 - 25	5 - 25	5 - 25	5 - 25	5 - 25	5 - 25	2.4
5 - 25	5 - 25	5 - 25	5 - 25	5 - 25	5 - 25	5 - 25	5 - 25	5 - 25	5 - 25	5 - 25	5 - 25	5 - 25	2.5
10 - 30	10 - 30	10 - 30	10 - 30	10 - 30	10 - 30	10 - 30	10 - 30	10 - 30	10 - 30	10 - 30	10 - 30	10 - 30	2.6
2 - 10	2 - 10	2 - 10	2 - 10	2 - 10	2 - 10	2 - 10	2 - 10	2 - 10	2 - 10	2 - 10	2 - 10	2 - 10	2.7
													2.8
													3.1
													3.2
10 - 40	10 - 40	10 - 40	10 - 40	10 - 40	10 - 40	10 - 40	10 - 40						4.1
													4.2
													4.3
													4.4
													5.1
													5.2
													5.3
								5 - 15	5 - 15	5 - 15	5 - 15	5 - 15	1.1
													1.2
													1.3
													2.1
													2.2
													2.3
													2.4
													2.5
													2.6
													1.1
													1.2
													1.3
													1.4
													1.5

Product Finder

V_c

M

MF

UNC
UN-8

UNF

G, Rp
NPSM, NPSF

NPT, NPTF
Rc, W

BSW, BSF

Pg

MJ
UNJC, UNJF

EG (ST)
SELF-LOCK

Tr, Tr-F
Rd

Zubehör
Accessories

Tech. Info

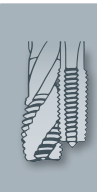

Product Finder

V_c

M

MF

UNC UN-8

UNF UNEF

G, Rp NPSM, NPSF

NPT, NPTF Rc, W

BSW, BSF

Pg

MJ UNJC, UNJF

EG (STI) SELF-LOCK

Tr, Tr-F Rd

Zubehör Accessories

Tech. Info

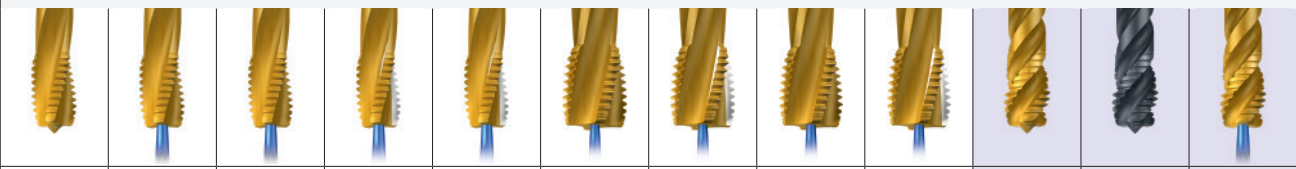

	Rekord D-Z TIN	Rekord D-Z- IKZ TIN	Rekord D-Z/E- IKZ TIN	Rekord D-Z-BF IKZ -TIN	Rekord D-Z/E-BF IKZ -TIN	Rekord D-Z- IKZ LF3-TIN	Rekord D-Z-BF- IKZ LF3-TIN	Rekord D-Z- IKZ LF4-TIN	Rekord D-Z-BF- IKZ LF4-TIN	Enorm Z-X-PM TIN-60	Enorm Z-X-PM GLT-1	Enorm Z-X- IKZ PM-TIN-60
	C / 2-3	C / 2-3	E / 1,5-2	C / 2-3	E / 1,5-2	C / 2-3	C / 2-3	C / 2-3	C / 2-3	C / 2-3	C / 2-3	C / 2-3
	max. 2 x d ₁				max. 3 x d ₁				max. 4 x d ₁		max. 3 x d ₁	
M	55, 78	55, 78	55, 78	55, 63, 78, 87	55, 78	88	88	89	89	56, 79	56, 79	56, 79
MF	121	121	121	121	121	128	128	129	129	122	122	122
UNC										142, 146	142, 146	142, 146
UNF										154, 158	154, 158	154, 158
UNEF												
UNEF, UN-8												
G, Rp										171	171	171
NPSM, NPSF												
NPT, NPTF												
Rc, W												
NPSM, NPSF												
NPT, NPTF, Rc												
W												
BSW, BSF												
Pg												
MJ												
UNJC, UNJF												
EG (STI)												
LK-M												
Tr, Tr-F, Rd												
P												
1.1												
2.1	10 - 40	10 - 40	10 - 40	10 - 40	10 - 40	10 - 40	10 - 40	10 - 40	10 - 40	10 - 60	10 - 60	10 - 60
3.1	5 - 25	5 - 25	5 - 25	5 - 25	5 - 25	5 - 25	5 - 25	5 - 25	5 - 25	5 - 40	5 - 40	5 - 40
4.1	5 - 20	5 - 20	5 - 20	5 - 20	5 - 20	5 - 20	5 - 20	5 - 20	5 - 20	5 - 30	5 - 30	5 - 30
5.1	2 - 10	2 - 10	2 - 10	2 - 10	2 - 10	2 - 10	2 - 10	2 - 10	2 - 10			
M												
1.1										5 - 20	5 - 20	5 - 20
2.1										5 - 20	5 - 20	5 - 20
3.1										5 - 15	5 - 15	5 - 15
4.1												
K												
1.1												
1.2												
2.1	10 - 30	10 - 30	10 - 30	10 - 30	10 - 30	10 - 30	10 - 30	10 - 30	10 - 30	10 - 30	10 - 30	10 - 30
2.2	10 - 25	10 - 25	10 - 25	10 - 25	10 - 25	10 - 25	10 - 25	10 - 25	10 - 25	10 - 30	10 - 30	10 - 30
3.1												
3.2												
4.1												
4.2												
N												
1.1												
1.2												
1.3												
1.4	15 - 40	15 - 40	15 - 40	15 - 40	15 - 40	15 - 40	15 - 40	15 - 40	15 - 40	15 - 40	15 - 40	15 - 40
1.5	15 - 40	15 - 40	15 - 40	15 - 40	15 - 40	15 - 40	15 - 40	15 - 40	15 - 40	15 - 40	15 - 40	15 - 40
1.6	10 - 30	10 - 30	10 - 30	10 - 30	10 - 30	10 - 30	10 - 30	10 - 30	10 - 30	10 - 30	10 - 30	10 - 30
2.1										5 - 30	5 - 30	5 - 30
2.2										20 - 60	20 - 60	20 - 60
2.3												
2.4	5 - 25	5 - 25	5 - 25	5 - 25	5 - 25	5 - 25	5 - 25	5 - 25	5 - 25	5 - 25	5 - 25	5 - 25
2.5	5 - 25	5 - 25	5 - 25	5 - 25	5 - 25	5 - 25	5 - 25	5 - 25	5 - 25	5 - 25	5 - 25	5 - 25
2.6												
2.7												
2.8												
3.1												
3.2												
4.1												
4.2												
4.3												
4.4												
5.1												
5.2												
5.3												
S												
1.1										5 - 15	5 - 15	5 - 15
1.2												
1.3												
2.1												
2.2												
2.3												
2.4												
2.5												
2.6												
H												
1.1												
1.2												
1.3												
1.4												
1.5												

Seite · Page

Vertriebspartner



Enorm Z-X- IKZ PM-GLT-1	Enorm Z/E-X- PM TIN-60	Enorm Z/E-X- PM GLT-1	Enorm Z/E-X- IKZ PM-TIN-60	Enorm Z/E-X- IKZ PM-GLT-1	Enorm Z	Enorm Z TIN	Enorm Z GLT-1	Enorm Z- IKZ GLT-1	Enorm Z/E	Enorm Z/E TIN	Enorm Z/E GLT-1
C / 2-3	E / 1,5-2	E / 1,5-2	E / 1,5-2	E / 1,5-2	C / 2-3	C / 2-3	C / 2-3	C / 2-3	E / 1,5-2	E / 1,5-2	E / 1,5-2

max. 3 x d₁



Gewindetiefe
und Lochform
Thread depth
and hole type

56, 79 122	56, 79 122	57, 79 123	57, 79 123	57, 79 123	58, 81	58, 81	58, 81	58, 81	59, 81, 91 107, 124	59, 81 107, 124	59, 81
	142, 146 154, 158	142, 146 154, 158			143, 147				143, 147 155, 159	143, 147 155, 159	
171	171	171	171	171					172, 180 182, 183	172, 180 182, 183	
					217, 219				217 - 227 229, 231	217 - 227 229, 231	

Seite . Page

					5 - 25	15 - 45	15 - 45	15 - 45	5 - 25	15 - 45	15 - 45	1.1
10 - 60	10 - 60	10 - 60	10 - 60	10 - 60	5 - 20	10 - 40	10 - 40	10 - 40	5 - 20	10 - 40	10 - 40	2.1
5 - 40	5 - 40	5 - 40	5 - 40	5 - 40	2 - 15	5 - 25	5 - 25	5 - 25	2 - 15	5 - 25	5 - 25	3.1
5 - 30	5 - 30	5 - 30	5 - 30	5 - 30	2 - 10	5 - 20	5 - 20	5 - 20	2 - 10	5 - 20	5 - 20	4.1
												5.1
5 - 20	5 - 20	5 - 20	5 - 20	5 - 20	2 - 10	5 - 20	5 - 20	5 - 20	2 - 10	5 - 20	5 - 20	1.1
5 - 20	5 - 20	5 - 20	5 - 20	5 - 20	2 - 10	5 - 20	5 - 20	5 - 20	2 - 10	5 - 20	5 - 20	2.1
5 - 15	5 - 15	5 - 15	5 - 15	5 - 15		5 - 15	5 - 15	5 - 15		5 - 15	5 - 15	3.1
												4.1
												1.1
												1.2
10 - 30	10 - 30	10 - 30	10 - 30	10 - 30								2.1
												2.2
												3.1
												3.2
												4.1
												4.2
												1.1
												1.2
												1.3
15 - 40	15 - 40	15 - 40	15 - 40	15 - 40		15 - 40	15 - 40	15 - 40		15 - 40	15 - 40	1.4
15 - 40	15 - 40	15 - 40	15 - 40	15 - 40		15 - 40	15 - 40	15 - 40		15 - 40	15 - 40	1.5
10 - 30	10 - 30	10 - 30	10 - 30	10 - 30		10 - 30	10 - 30	10 - 30		10 - 30	10 - 30	1.6
5 - 30	5 - 30	5 - 30	5 - 30	5 - 30	5 - 20	5 - 30	5 - 30	5 - 30	5 - 20	5 - 30	5 - 30	2.1
20 - 60	20 - 60	20 - 60	20 - 60	20 - 60		20 - 60	20 - 60	20 - 60		20 - 60	20 - 60	2.2
												2.3
5 - 25	5 - 25	5 - 25	5 - 25	5 - 25		5 - 25	5 - 25	5 - 25		5 - 25	5 - 25	2.4
5 - 25	5 - 25	5 - 25	5 - 25	5 - 25		5 - 25	5 - 25	5 - 25		5 - 25	5 - 25	2.5
												2.6
												2.7
												2.8
												3.1
												3.2
												4.1
												4.2
												4.3
												4.4
												5.1
												5.2
												5.3
5 - 15	5 - 15	5 - 15	5 - 15	5 - 15		5 - 15	5 - 15	5 - 15		5 - 15	5 - 15	1.1
												1.2
												1.3
												2.1
												2.2
												2.3
												2.4
												2.5
												2.6
												1.1
												1.2
												1.3
												1.4
												1.5

Product Finder

V_c

M

MF

UNC
UN-8

UNF

G, Rp
NPSM, NPSF

NPT, NPTF
Rc, W

BSW, BSF

Pg

MJ
UNJC, UNJF

EG (STI)
SELF-LOCK

Tr, Tr-F
Rd

Zubehör
Accessories

Tech. Info



Product Finder

V_c

M

MF

UNC UN-8

UNF UNF

G, Rp NPSM, NPSF

NPT, NPTF Rc, W

BSW, BSF

Pg

MJ UNJC, UNJF

EG (STI) SELF-LOCK

Tr, Tr-F Rd

Zubehör Accessories

Tech. Info

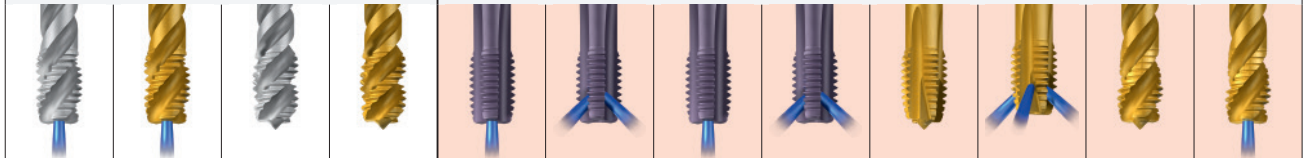

	Enorm Z/E-IKZ	Enorm Z/E-IKZ TIN	Enorm Z50	Enorm Z50 TIN	Rekord A-SPEED IKZ-TICN	Rekord A-SPEED IKZN-TICN	Rekord A-SPEED/E IKZ-TICN	Rekord A-SPEED/E IKZN-TICN	Rekord B-Z-SPEED PM-TIN-70	Rekord B-Z-SPEED-IKZN PM-TIN-70	Enorm Z-SPEED-X PM-TIN-60	Enorm Z-SPEED-X-IKZ PM-TIN-60
	E / 1,5-2	E / 1,5-2	C / 2-3	C / 2-3	C / 2-3	C / 2-3	E / 1,5-2	E / 1,5-2	B / 4-5	B / 4-5	C / 2-3	C / 2-3
Gewindtiefe und Lochform Thread depth and hole type	max. 3 x d ₁ 				max. 2 x d ₁ 		max. 2 x d ₁ 		max. 3 x d ₁ 		max. 3 x d ₁ 	
M	59	59,81	59,82	59,82	60,83	60,83	60,83	60,83	61,83	61,83	61,83	61,83
MF	124	124			125	125	125	125	125	125	125	125
UNC UN-8												
UNF UNF												
G, Rp NPSM, NPSF												
NPT, NPTF Rc, W												
BSW, BSF												
Pg												
MJ UNJC, UNJF												
EG (STI) SELF-LOCK												
Tr, Tr-F Rd												
Zubehör Accessories												
Tech. Info												
P												
1.1	5 - 25	15 - 45	5 - 25	15 - 45					40 - 80	40 - 80		
2.1	5 - 20	10 - 40	5 - 20	10 - 40					30 - 60	30 - 60	30 - 60	30 - 60
3.1	2 - 15	5 - 25	2 - 15	5 - 25					20 - 40	20 - 40	20 - 40	20 - 40
4.1	2 - 10	5 - 20	2 - 10	5 - 20					10 - 30	10 - 30	10 - 30	10 - 30
5.1												
M												
1.1	2 - 10	5 - 20	2 - 10	5 - 20								
2.1	2 - 10	5 - 20	2 - 10	5 - 20								
3.1		5 - 15		5 - 15								
4.1												
K												
1.1					40 - 80	40 - 80	40 - 80	40 - 80				
1.2					30 - 60	30 - 60	30 - 60	30 - 60				
2.1					30 - 60	30 - 60	30 - 60	30 - 60	30 - 60	30 - 60		
2.2					20 - 40	20 - 40	20 - 40	20 - 40	20 - 40	20 - 40		
3.1					20 - 40	20 - 40	20 - 40	20 - 40				
3.2					20 - 40	20 - 40	20 - 40	20 - 40				
4.1					40 - 80	40 - 80	40 - 80	40 - 80				
4.2					30 - 60	30 - 60	30 - 60	30 - 60				
N												
1.1												
1.2												
1.3												
1.4		15 - 40		15 - 40	20 - 60	20 - 60	20 - 60	20 - 60	20 - 60	20 - 60		
1.5		15 - 40		15 - 40	20 - 60	20 - 60	20 - 60	20 - 60	20 - 60	20 - 60		
1.6		10 - 30		10 - 30	20 - 40	20 - 40	20 - 40	20 - 40	20 - 40	20 - 40		
2.1	5 - 20	5 - 30	5 - 20	5 - 30								
2.2		20 - 60		20 - 60								
2.3												
2.4		5 - 25		5 - 25								
2.5		5 - 25		5 - 25								
2.6												
2.7												
2.8												
3.1												
3.2												
4.1												
4.2												
4.3												
4.4												
5.1												
5.2												
5.3												
S												
1.1		5 - 15		5 - 15								
1.2												
1.3												
2.1												
2.2												
2.3												
2.4												
2.5												
2.6												
H												
1.1												
1.2												
1.3												
1.4												
1.5												

SET

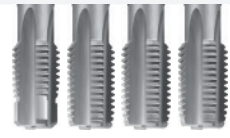
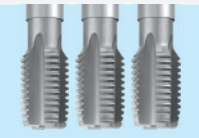

HGB-Set

VHM/KHM-Set

WM-Set

WM-Set
TIN

WM-F-TIC-Set

C / 2-3

C / ≈3

C / 2-3

C / 2-3

C / 2-3

max. 2 x d₁



Gewindetiefe
und Lochform
Thread depth
and hole type

92
132
149
161

93
135

94
136
150
162

96

98

175

176

205, 208

M
MF
UNC
UNF
G, Rp
NPSM, NPSF
NPT, NPTF
Rc, W
BSW, BSF
Pg
MJ
UNJC, UNJF
EG (ST)
LK-M
Tr, Tr-F, Rd

1-3

1-3

1-3

1.1

1-3

1-3

1-3

2.1

1-3

1-3

1-3

1-3

3.1

1-3

1-3

1-3

4.1

1-3

1-3

1-3

1-3

5.1

1-3

1-3

1.1

1-3

1-3

2.1

1-3

1-3

3.1

1-3

1-3

4.1

1.1

1.2

2.1

2.2

3.1

3.2

4.1

4.2

1.1

1.2

1.3

1.4

1.5

1.6

2.1

2.2

2.3

2.4

2.5

2.6

2.7

2.8

3.1

3.2

4.1

4.2

4.3

4.4

5.1

5.2

5.3

1.1

1.2

1.3

2.1

2.2

2.3

2.4

2.5

2.6

1.1

1.2

1.3

1.4

1.5

Product
Finder

v_c

M

MF

UNC

UN-8

UNF

UNEF

G, Rp

NPSM, NPSF

NPT, NPTF

Rc, W

BSW, BSF

Pg

MJ

UNJC, UNJF

EG (ST)

SELF-LOCK

Tr, Tr-F

Rd













Zubehör
Accessories

Tech. Info



v_c in m/min

- Product Finder
- V_c
- M
- MF
- UNC UN-8
- UNF UNEF
- G, Rp NPSM, NPSF
- NPT, NPTF Rc, W
- BSW, BSF
- Pg
- MJ UNJC, UNJF
- EG (STI) SELF-LOCK
- Tr, Tr-F Rd
- Zubehör Accessories
- Tech. Info

		EMUGE MS				EMUGE STEEL		EMUGE VA			
		AUT-A	KOMBI	MMB	KEG	Rekord KEG STEEL	Rekord KEG STEEL-AZ	Rekord KEG VA	Rekord KEG VA-AZ	Rekord KEG R35-VA	Rekord KEG R35-VA-AZ
											
		AUT-A MS-R	KOMBI	MMB DIN 357		Rekord KEG STEEL	Rekord KEG STEEL-AZ	Rekord KEG VA	Rekord KEG VA-AZ	Rekord KEG R35-VA	Rekord KEG R35-VA-AZ
		max. 1	C / 2-3	—		C / 2-3	C / 2-3	C / 2-3	C / 2-3	C / 2-3	C / 2-3
Gewindetiefe und Lochform Thread depth and hole type		max. 1 x d ₁ 	max. 1 x d ₁ 	max. 1,5 x d ₁ 		—		—			
M		138	100	101							
MF		178, 181	139								
UNC UN-8						185 - 197 198	189	185 - 196	185, 187	186 - 192	186, 188
UNF UNEF											
G, Rp NPSM, NPSF											
NPT, NPTF Rc, W											
BSW, BSF											
Pg											
MJ UNJC, UNJF											
EG (STI) SELF-LOCK											
Tr, Tr-F Rd											
P	1.1		5 - 25	5 - 25		2 - 8	2 - 8	2 - 8	2 - 8	2 - 8	2 - 8
	2.1		5 - 20	5 - 20		2 - 6	2 - 6	2 - 6	2 - 6	2 - 6	2 - 6
	3.1							1 - 8	1 - 8	1 - 8	1 - 8
	4.1							1 - 5	1 - 5		
	5.1										
M	1.1							1 - 8	1 - 8	1 - 8	1 - 8
	2.1							1 - 8	1 - 8	1 - 8	1 - 8
	3.1							1 - 5	1 - 5	1 - 5	1 - 5
	4.1										
K	1.1					2 - 10	2 - 10				
	1.2					2 - 10	2 - 10				
	2.1							2 - 8	2 - 8		
	2.2							2 - 8	2 - 8		
	3.1							2 - 8	2 - 8		
	3.2							2 - 8	2 - 8		
	4.1							2 - 10	2 - 10		
4.2							2 - 10	2 - 10			
N	1.1										
	1.2										
	1.3										
	1.4							2 - 10			
	1.5							2 - 10			
	1.6										
	2.1										
	2.2			10 - 40	10 - 40		2 - 10	2 - 10			
	2.3						2 - 10	2 - 10			
	2.4		10 - 40						1 - 8	1 - 8	
	2.5								1 - 8	1 - 8	
	2.6		5 - 20						1 - 8	1 - 8	
	2.7										
	2.8										
	3.1										
	3.2										
4.1											
4.2											
4.3											
4.4											
5.1											
5.2											
5.3											
S	1.1										
	1.2										
	1.3										
	2.1										
	2.2										
	2.6										
H	1.1										
	1.2										
	1.3										
	1.4										
	1.5										

Seite · Page

V_c in m/min

4) Bei entsprechender Einspannlänge bis ca. 2,5 x d₁
With sufficient clamping length up to approx. 2.5 x d₁

EMUGE NI	TRAPEZ	EMUGE STEEL		EMUGE VA		EMUGE MS	RUND	EMUGE STEEL	
Rekord KEG R10-NI-PM-TiCN		TRAPEZ 2Stuf STEEL	TRAPEZ Rekord C-STEEL	TRAPEZ AM-VA NT	TRAPEZ Rekord C-VA-NT	TRAPEZ AUT A-MS		RUND Rekord A-STEEL	
C / 2-3						E / 1,5-2		C / 2-3	
		max. 2 x d ₁ 4)	max. 2 x d ₁ 4)	max. 1,5 x d ₁	max. 2 x d ₁	max. 1 x d ₁		max. 1 x d ₁	
									Gewindetiefe und Lochform Thread depth and hole type
186, 191									M MF UNC UNF G, Rp NPSM, NPSF NPT, NPTF Rc, W BSW, BSF Pg MJ UNJC, UNJF EG (ST) LK-M Tr, Tr-F, Rd
		232	235	233	235	234, 236		237	
		2 - 8	2 - 8	2 - 8	2 - 8			2 - 8	1.1
		2 - 6	2 - 6	2 - 6	2 - 6			2 - 6	2.1
		1 - 8		1 - 8	1 - 8				3.1
									4.1
									5.1
				1 - 8	1 - 8				1.1
1 - 8				1 - 8	1 - 8				2.1
1 - 5									3.1
1 - 3									4.1
		2 - 10						2 - 10	1.1
		2 - 10						2 - 10	1.2
				2 - 8	2 - 8			2 - 8	2.1
				2 - 8	2 - 8			2 - 8	2.2
				2 - 8	2 - 8			2 - 8	3.1
				2 - 8	2 - 8			2 - 8	3.2
				2 - 10	2 - 10			2 - 10	4.1
				2 - 10	2 - 10			2 - 10	4.2
									1.1
									1.2
									1.3
									1.4
									1.5
									1.6
									2.1
		2 - 10				2 - 10		2 - 10	2.2
		2 - 10						2 - 10	2.3
				1 - 8	1 - 8				2.4
				1 - 8	1 - 8				2.5
		1 - 8		1 - 8	1 - 8				2.6
									2.7
									2.8
									3.1
									3.2
									4.1
									4.2
									4.3
									4.4
									5.1
									5.2
									5.3
									1.1
									1.2
									1.3
									2.1
1 - 3									2.2
									2.3
1 - 3									2.4
1 - 3									2.5
									2.6
									1.1
									1.2
									1.3
									1.4
									1.5

Product
Finder

v_c

M

MF

UNC
UN-8

UNF
UNEF

G, Rp
NPSM, NPSF

NPT, NPTF
Rc, W

BSW, BSF

Pg

MJ

UNJC, UNJF

EG (ST)
SELF-LOCK

Tr, Tr-F
Rd

Zubehör
Accessories

Tech. Info

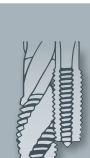

- Product Finder
- V_c
- M
- MF
- UNC UN-8
- UNF UNEF
- G, Rp NPSM, NPSF
- NPT, NPTF Rc, W
- BSW, BSF
- Pg
- MJ UNJC, UNJF
- EG (STI) SELF-LOCK
- Tr, Tr-F Rd
- Zubehör Accessories
- Tech. Info



DIN 13

DIN 371

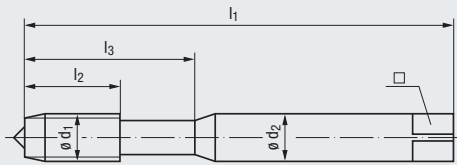

STEEL
Steel materials



Toleranz · Tolerance
Beschichtung · Coating
Schneidstoff · Cutting material

Technische Informationen
Technical information

» 245 - 266

6HX	6HX	ISO 2/6H	ISO 2/6H	ISO 2/6H
HSSE	HSSE	HSSE	TIN	GLT-1
C / 2-3	C / 2-3	B / 4-5	B / 4-5	B / 4-5
E / 0	E / 0	E / 0	E / 0	E / 0

Gewindetiefe und Lochform
Thread depth and hole type



Einsatzgebiete – Material
Applications – material

» 22

P 1.1-3.1	P 1.1-3.1	P 1.1-3.1	P 1.1-4.1	P 1.1-4.1
N 2.3	N 2.3	N 2.2	K 2.1	K 2.1
			N 2.2, 2.4-5	

Werkzeug-Ident · Tool ident

M	ø d ₁ mm	P mm	l ₁	l ₂	l ₃	ø d ₂	□	Dimens.- Ident	Rekord	Rekord	Rekord	Rekord	Rekord	
									1A-STEEL	1A-STEEL-AZ	1B-STEEL-L	1B-STEEL-L TIN	1B-STEEL-L GLT-1	
	1	0,25	40	5	–	2,5	2,1	0,75	.0010	●*)		●*)	○*)	
	1,1	0,25	40	5	–	2,5	2,1	0,85	.0011	●*)		●*)	○*)	
	1,2	0,25	40	5	–	2,5	2,1	0,95	.0012	●*)		●*)	○*)	
	1,4	0,3	40	6	–	2,5	2,1	1,1	.0014	●*)		●*)	○*)	
	1,6	0,35	40	6	11	2,5	2,1	1,25	.0016	●		●	●	
	1,7	0,35	40	6	11	2,5	2,1	1,35	.0017	●		●	○	
	1,8	0,35	40	6	11	2,5	2,1	1,45	.0018	●		●	○	
	2	0,4	45	7	12	2,8	2,1	1,6	.0020	●		●	●	
	2,2	0,45	45	7	12	2,8	2,1	1,75	.0022	●		●	○	
	2,3	0,4	45	7	12	2,8	2,1	1,9	.0023	●		●	○	
	2,5	0,45	50	9	14	2,8	2,1	2,05	.0025	●		●	●	
	2,6	0,45	50	9	14	2,8	2,1	2,15	.0026	●		○	○	
	3	0,5	56	11	18	3,5	2,7	2,5	.0030	●	●	●	●	
	3,5	0,6	56	12	20	4	3	2,9	.0035	●		○	○	
	4	0,7	63	13	21	4,5	3,4	3,3	.0040	●	●	●	●	
	4,5	0,75	70	14	25	6	4,9	3,7	.0045	●		●	○	
	5	0,8	70	15	25	6	4,9	4,2	.0050	●	●	●	●	
	5,5	0,9	80	16	30	6	4,9	4,6	.0055	●		●	○	
	6	1	80	17	30	6	4,9	5	.0060	●	●	●	●	
	7	1	80	17	30	7	5,5	6	.0070	●		●	○	
	8	1,25	90	20	35	8	6,2	6,8	.0080	●	●	●	●	
	9	1,25	90	20	35	9	7	7,8	.0090	●		●	○	
	10	1,5	100	22	39	10	8	8,5	.0100	●	●	●	●	
	12	1,75	110	24	44	12	9	10,2	.0112	●		●	○	



DIN 376	64	64	64	64	
DIN 352	90	90			

*) ≤ M1,4 Tol. 4H(X)/5H(X)

- Product Finder
- V_c
- M
- MF
- UNC UN-8
- UNF UNEF
- G, Rp NPSM, NPSF
- NPT, NPTF Rc, W
- BSW, BSF
- Pg
- MJ UNJC, UNJF
- EG (STI) SELF-LOCK
- Tr, Tr-F Rd
- Zubehör Accessories
- Tech. Info



DIN 13

DIN 371

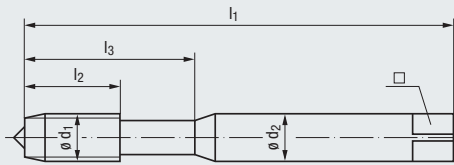

STEEL
Steel materials



Toleranz · Tolerance
Beschichtung · Coating
Schneidstoff · Cutting material

Technische Informationen
Technical information

» 245 - 266

ISO 2/6H	ISO 3/6G	ISO 3/6G	7G	7G
GLT-1		TIN		TIN
HSSE	HSSE	HSSE	HSSE	HSSE
B / 4-5	B / 4-5	B / 4-5	B / 4-5	B / 4-5
E / O	E / O	E / O	E / O	E / O

Gewindetiefe und Lochform
Thread depth and hole type

max. 3 x d₁



Einsatzgebiete – Material
Applications – material

» 22

P 2.1-4.1	P 2.1-4.1	P 2.1-4.1	P 2.1-4.1	P 2.1-4.1
K 2.1		K 2.1		K 2.1

Werkzeug-Ident · Tool ident

M	Ø d ₁ mm	P mm	l ₁	l ₂	l ₃	Ø d ₂	□	Image	Dimens.-Ident	B020C000	B0201020	B0201420	B0201030	B0201430
										Rekord 1B-STEEL-M GLT-1	Rekord 1B-STEEL-M „6G“	Rekord 1B-STEEL-M TIN „6G“	Rekord 1B-STEEL-M „7G“	Rekord 1B-STEEL-M TIN „7G“
	1	0,25	40	5	–	2,5	2,1	0,75	.0010					
	1,1	0,25	40	5	–	2,5	2,1	0,85	.0011					
	1,2	0,25	40	5	–	2,5	2,1	0,95	.0012					
	1,4	0,3	40	6	–	2,5	2,1	1,1	.0014					
	1,6	0,35	40	6	11	2,5	2,1	1,25	.0016	•				
	1,7	0,35	40	6	11	2,5	2,1	1,35	.0017					
	1,8	0,35	40	6	11	2,5	2,1	1,45	.0018					
	2	0,4	45	7	12	2,8	2,1	1,6	.0020	•	•		•	
	2,2	0,45	45	7	12	2,8	2,1	1,75	.0022					
	2,3	0,4	45	7	12	2,8	2,1	1,9	.0023					
	2,5	0,45	50	9	14	2,8	2,1	2,05	.0025	•	•		•	
	2,6	0,45	50	9	14	2,8	2,1	2,15	.0026					
	3	0,5	56	11	18	3,5	2,7	2,5	.0030		•	○	•	○
	3,5	0,6	56	12	20	4	3	2,9	.0035					
	4	0,7	63	13	21	4,5	3,4	3,3	.0040		•	○	•	○
	4,5	0,75	70	14	25	6	4,9	3,7	.0045					
	5	0,8	70	15	25	6	4,9	4,2	.0050		•	○	•	○
	5,5	0,9	80	16	30	6	4,9	4,6	.0055					
	6	1	80	17	30	6	4,9	5	.0060		•	○	•	○
	7	1	80	17	30	7	5,5	6	.0070					
	8	1,25	90	20	35	8	6,2	6,8	.0080		•	○	•	○
	9	1,25	90	20	35	9	7	7,8	.0090					
	10	1,5	100	22	39	10	8	8,5	.0100		•	○	•	○
	12	1,75	110	24	44	12	9	10,2	.0112					



2) < M3 mit GLT-1-Beschichtung auf Anfrage
< M3 with GLT-1 coating upon request

STEEL
Steel
materials

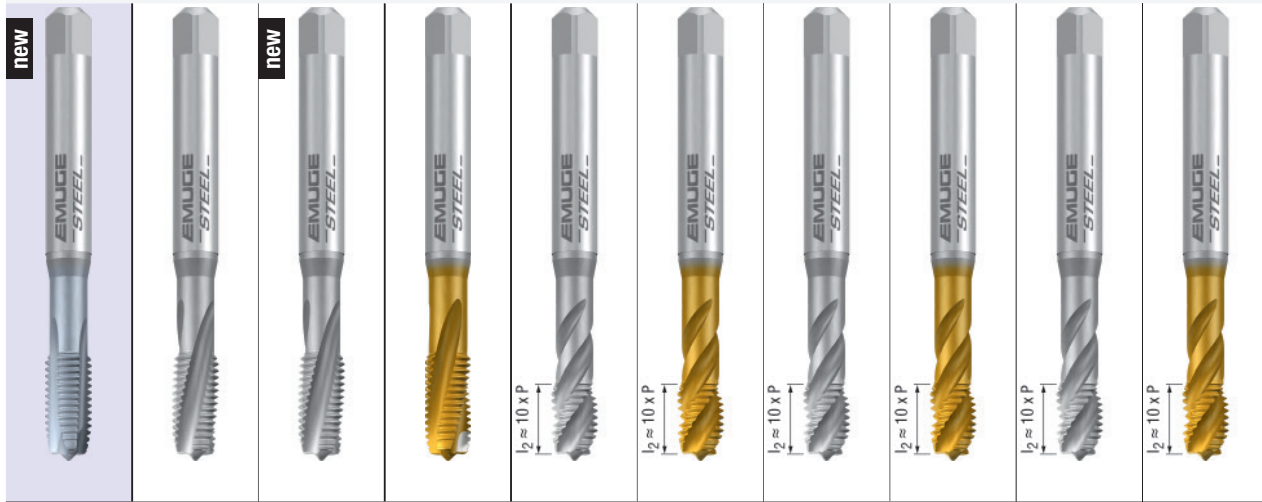

6HX	ISO 2/6H	ISO 2/6H	ISO 2/6H	ISO 2/6H	ISO 2/6H	ISO 1/4H	ISO 1/4H	ISO 3/6G	ISO 3/6G
CRT			TIN		TIN		TIN		TIN
HSSE-PM	HSSE	HSSE	HSSE	HSSE	HSSE	HSSE	HSSE	HSSE	HSSE
	R15	R15	R15	R35	R35	R35	R35	R35	R35
B / ≈6	C / 2-3	E / 1,5-2	C / 2-3	C / 2-3	C / 2-3	C / 2-3	C / 2-3	C / 2-3	C / 2-3
E / 0	E / 0	E / 0	E / 0	E / 0	E / 0	E / 0	E / 0	E / 0	E / 0



P 3.1-5.1	P 2.1-3.1	P 2.1-3.1	P 1.1-4.1 K 1.1-4.2 N 1.4-5, 2.4-5	P 1.1-3.1 N 2.2	P 1.1-4.1 K 2.1 N 2.2	P 1.1-3.1 N 2.2	P 1.1-4.1 K 2.1 N 2.2	P 1.1-3.1 N 2.2	P 1.1-4.1 K 2.1 N 2.2
-----------	-----------	-----------	--	--------------------	-----------------------------	--------------------	-----------------------------	--------------------	-----------------------------

B0208E01	B0451000	B0461000	B0401400	B0501000	B0501400	B0501010	B0501410	B0501020	B0501420
Rekord 1B-STEEL-H PM-CRT	Rekord 1D-STEEL	Rekord 1D-STEEL/E	Rekord 1DF-STEEL TIN	Enorm 1-STEEL	Enorm 1-STEEL TIN	Enorm 1-STEEL „4H“	Enorm 1-STEEL TIN „4H“	Enorm 1-STEEL „6G“	Enorm 1-STEEL TIN „6G“

										M	1
											1,1
											1,2
											1,4
											1,6
											1,7
											1,8
											2
											2,2
											2,3
											2,5
											2,6
											3
											3,5
											4
											4,5
											5
											5,5
											6
											7
											8
											9
											10
											12
65	66	66	66	66	66	67	67	67	67		
	91			91							

*) ≤ M1,4 Tol. 4H/5H

- Product Finder
- V_c
- M
- MF
- UNC UN-8
- UNF UNEF
- G, Rp NPSM, NPSF
- NPT, NPTF Rc, W
- BSW, BSF
- Pg
- MJ UNJC, UNJF
- EG (STI) SELF-LOCK
- Tr, Tr-F Rd
- Zubehör Accessories
- Tech. Info



- Product Finder
- V_c
- M
- MF
- UNC UN-8
- UNF UNEF
- G, Rp NPSM, NPSF
- NPT, NPTF Rc, W
- BSW, BSF
- Pg
- MJ UNJC, UNJF
- EG (STI) SELF-LOCK
- Tr, Tr-F Rd
- Zubehör Accessories
- Tech. Info



DIN 13

DIN 371

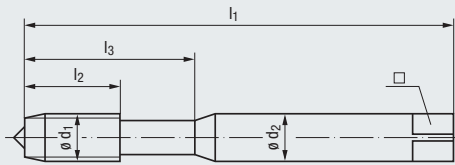

STEEL
Steel materials

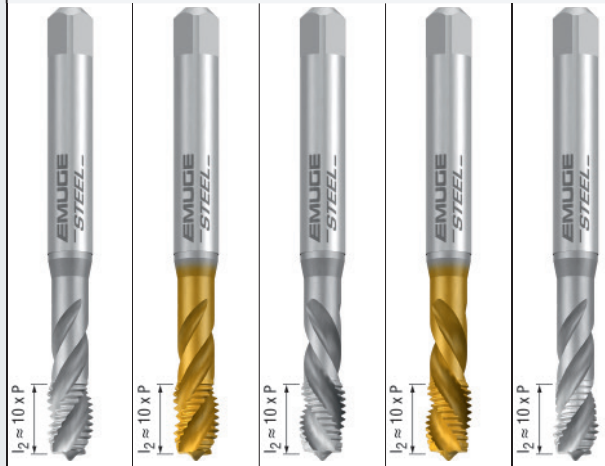

Toleranz · Tolerance
Beschichtung · Coating
Schneidstoff · Cutting material

Technische Informationen
Technical information

» 245 - 266



7G	7G	ISO 2/6H	ISO 2/6H	ISO 2/6H
TIN	TIN	TIN	TIN	TIN
HSSE	HSSE	HSSE	HSSE	HSSE
R35	R35	LH, L35	LH, L35	R35
C / 2-3	C / 2-3	C / 2-3	C / 2-3	C / 2-3
E / O	E / O	E / O	E / O	E / O

Gewindetiefe und Lochform
Thread depth and hole type

max. 2,5 x d₁



Einsatzgebiete – Material
Applications – material

» 22

P 1.1-3.1	P 1.1-4.1	P 1.1-3.1	P 1.1-4.1	P 1.1-3.1
N 2.2	K 2.1	N 2.2	K 2.1	N 2.2
	N 2.2		N 2.2	

Werkzeug-Ident · Tool ident

B0501030 B0501430 B0501050 B0501450 B0601000

M	d ₁ mm	P mm	l ₁	l ₂	l ₃	d ₂	□	Image	Dimens.- Ident	Enorm	Enorm	Enorm	Enorm	Enorm
										1-STEEL „7G“	1-STEEL TIN „7G“	1-STEEL-LH	1-STEEL-LH TIN	1-STEEL-X
1	1,1	0,25	40	5	–	2,5	2,1	0,75	.0010					
1,1	1,1	0,25	40	5	–	2,5	2,1	0,85	.0011					
1,2	1,2	0,25	40	5	–	2,5	2,1	0,95	.0012					
1,4	1,4	0,3	40	6	–	2,5	2,1	1,1	.0014					
1,6	1,6	0,35	40	6	11	2,5	2,1	1,25	.0016					
1,7	1,7	0,35	40	6	11	2,5	2,1	1,35	.0017					
1,8	1,8	0,35	40	6	11	2,5	2,1	1,45	.0018					
2	2	0,4	45	7	12	2,8	2,1	1,6	.0020	●	●	○		
2,2	2,2	0,45	45	7	12	2,8	2,1	1,75	.0022					
2,3	2,3	0,4	45	7	12	2,8	2,1	1,9	.0023					
2,5	2,5	0,45	50	9	14	2,8	2,1	2,05	.0025	●	●	○		
2,6	2,6	0,45	50	9	14	2,8	2,1	2,15	.0026					
3	3	0,5	56	11	18	3,5	2,7	2,5	.0030	●	●	●	●	●
3,5	3,5	0,6	56	12	20	4	3	2,9	.0035					
4	4	0,7	63	13	21	4,5	3,4	3,3	.0040	●	●	●	●	●
4,5	4,5	0,75	70	14	25	6	4,9	3,7	.0045					
5	5	0,8	70	15	25	6	4,9	4,2	.0050	●	●	●	●	●
5,5	5,5	0,9	80	16	30	6	4,9	4,6	.0055					
6	6	1	80	17	30	6	4,9	5	.0060	●	●	●	●	●
7	7	1	80	17	30	7	5,5	6	.0070					
8	8	1,25	90	20	35	8	6,2	6,8	.0080	●	●	●	●	●
9	9	1,25	90	20	35	9	7	7,8	.0090					
10	10	1,5	100	22	39	10	8	8,5	.0100	●	●	●	●	●
12	12	1,75	110	24	44	12	9	10,2	.0112					

DIN 376



» 67

» 67

» 67

» 67

» 67

DIN 352



STEEL Steel materials	VA Stainless steel materials								
				new 	new 	new 			new
ISO 2/6H	ISO 2/6H	ISO 2/6H	ISO 2/6H	ISO 1/4H	ISO 1/4H	ISO 1/4H	ISO 3/6G	ISO 3/6G	
TIN	NT	TIN	GLT-1	NT	TIN	GLT-1	NT	TIN	
HSSE	HSSE	HSSE	HSSE	HSSE	HSSE	HSSE	HSSE	HSSE	
R35									
C / 2-3	B / 4-5	B / 4-5	B / 4-5	B / 4-5	B / 4-5	B / 4-5	B / 4-5	B / 4-5	B / 4-5
E / 0	E / 0 / P	E / 0 / P	E / 0 / P	E / 0 / P	E / 0 / P	E / 0 / P	E / 0 / P	E / 0 / P	E / 0 / P
max. 2,5 x d ₁ 	max. 3 x d ₁ 								
P 1.1-4.1 K 2.1 N 2.2	P 1.1-3.1 M 1.1-2.1 K 2.1 N 2.2, 2.5-6	P 1.1-4.1 M 1.1-3.1 K 2.1 N 2.2, 2.5-6	P 1.1-4.1 M 1.1-3.1 K 2.1 N 2.2	P 1.1-3.1 M 1.1-2.1 K 2.1 N 2.2, 2.5-6	P 1.1-4.1 M 1.1-3.1 K 2.1 N 2.2, 2.5-6	P 1.1-4.1 M 1.1-3.1 K 2.1 N 2.2	P 1.1-3.1 M 1.1-2.1 K 2.1 N 2.2, 2.5-6	P 1.1-4.1 M 1.1-3.1 K 2.1 N 2.2, 2.5-6	P 1.1-4.1 M 1.1-3.1 K 2.1 N 2.2, 2.5-6
B0601400	B0203000	B0203100	B020C300	B0203010	B0203110	B020C310	B0203020	B0203120	
Enorm 1-STEEL-X TIN	Rekord 1B-VA NT	Rekord 1B-VA TIN	Rekord 1B-VA GLT-1	Rekord 1B-VA NT „4H“	Rekord 1B-VA TIN „4H“	Rekord 1B-VA GLT-1 „4H“	Rekord 1B-VA NT „6G“	Rekord 1B-VA TIN „6G“	
	●)	●)	●)						M 1
	●)	●)	●)						1,1
	●)	●)	●)						1,2
	●)	●)	●)						1,4
	●)	●)	●)						1,6
	●)	●)	●)						1,7
	●)	●)	●)	●)			○)		1,8
	●)	●)	●)	●)	●)		○)	●)	2
	●)	●)	●)	●)	●)	○)	○)	●)	2,2
	●)	●)	●)	●)	●)	○)	○)	●)	2,3
	●)	●)	●)	●)	●)	○)	○)	●)	2,5
●)	●)	●)	●)	●)	●)	○)	○)	●)	2,6
●)	●)	●)	●)	●)	●)	○)	○)	○)	3
●)	●)	●)	●)	●)	●)	○)	○)	○)	3,5
●)	●)	●)	●)	●)	●)	○)	○)	○)	4
●)	●)	●)	●)	●)	●)	○)	○)	○)	4,5
●)	●)	●)	●)	●)	●)	○)	○)	○)	5
●)	●)	●)	●)	●)	●)	○)	○)	○)	5,5
●)	●)	●)	●)	●)	●)	○)	○)	○)	6
●)	●)	●)	●)	●)	●)	○)	○)	○)	7
●)	●)	●)	●)	●)	●)	○)	○)	○)	8
●)	●)	●)	●)	●)	●)	○)	○)	○)	9
●)	●)	●)	●)	●)	●)	○)	○)	○)	10
●)	●)	●)	●)	●)	●)	○)	○)	○)	12

*) ≤ M1,4 Tol. 4H/5H

Product
Finder

Vc

M

MF

UNC
UN-8

UNF
UNEF

G, Rp
NPSM, NPSF

NPT, NPTF
Rc, W

BSW, BSF

Pg

MJ
UNJC, UNJF

EG (STI)
SELF-LOCK

Tr, Tr-F
Rd

Zubehör
Accessories

Tech. Info



- Product Finder
- V_c
- M
- MF
- UNC UN-8
- UNF UNEF
- G, Rp NPSM, NPSF
- NPT, NPTF Rc, W
- BSW, BSF
- Pg
- MJ UNJC, UNJF
- EG (STI) SELF-LOCK
- Tr, Tr-F Rd
- Zubehör Accessories
- Tech. Info

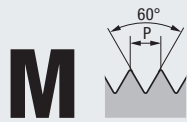

DIN 13

DIN 371

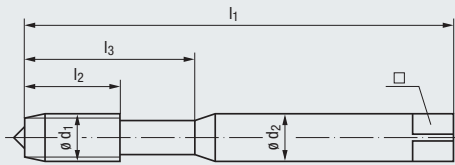

Toleranz · Tolerance
Beschichtung · Coating
Schneidstoff · Cutting material

Technische Informationen
Technical information

» 245 - 266



ISO 3/6G	7G	7G	7G	ISO 2/6H
GLT-1	NT	TIN	GLT-1	NT
HSSE	HSSE	HSSE	HSSE	HSSE
B / 4-5	B / 4-5	B / 4-5	B / 4-5	B / 4-5
E / O / P	E / O / P	E / O / P	E / O / P	E / O / P

Gewindetiefe und Lochform
Thread depth and hole type

max. 3 x d₁



Einsatzgebiete – Material
Applications – material

» 22

P 1.1-4.1	P 1.1-3.1	P 1.1-4.1	P 1.1-4.1	P 1.1-3.1
M 1.1-3.1	M 1.1-2.1	M 1.1-3.1	M 1.1-3.1	M 1.1-2.1
K 2.1	K 2.1	K 2.1	K 2.1	K 2.1
N 2.2	N 2.2, 2.5-6	N 2.2, 2.5-6	N 2.2	N 2.2, 2.5-6

Werkzeug-Ident · Tool ident

M	ø d ₁ mm	P mm	l ₁	l ₂	l ₃	ø d ₂	□	Dimens.- Ident	Rekord 1B-VA GLT-1 „6G“	Rekord 1B-VA NT „7G“	Rekord 1B-VA TIN „7G“	Rekord 1B-VA GLT-1 „7G“	Rekord 1B-VA-LH NT
									B020C320	B0203030	B0203130	B020C330	B0203050
1	1,1	0,25	40	5	–	2,5	2,1	0,75	.0010				
1,1	1,1	0,25	40	5	–	2,5	2,1	0,85	.0011				
1,2	1,2	0,25	40	5	–	2,5	2,1	0,95	.0012				
1,4	1,4	0,3	40	6	–	2,5	2,1	1,1	.0014				
1,6	1,6	0,35	40	6	11	2,5	2,1	1,25	.0016				
1,7	1,7	0,35	40	6	11	2,5	2,1	1,35	.0017				
1,8	1,8	0,35	40	6	11	2,5	2,1	1,45	.0018				
2	2	0,4	45	7	12	2,8	2,1	1,6	.0020	○	●	○	●
2,2	2,2	0,45	45	7	12	2,8	2,1	1,75	.0022				
2,3	2,3	0,4	45	7	12	2,8	2,1	1,9	.0023				
2,5	2,5	0,45	50	9	14	2,8	2,1	2,05	.0025	○	●	○	●
2,6	2,6	0,45	50	9	14	2,8	2,1	2,15	.0026				
3	3	0,5	56	11	18	3,5	2,7	2,5	.0030	○	●	○	●
3,5	3,5	0,6	56	12	20	4	3	2,9	.0035	○	●	○	●
4	4	0,7	63	13	21	4,5	3,4	3,3	.0040	○	●	○	●
4,5	4,5	0,75	70	14	25	6	4,9	3,7	.0045				
5	5	0,8	70	15	25	6	4,9	4,2	.0050	○	●	○	●
5,5	5,5	0,9	80	16	30	6	4,9	4,6	.0055				
6	6	1	80	17	30	6	4,9	5	.0060	○	●	○	●
7	7	1	80	17	30	7	5,5	6	.0070				
8	8	1,25	90	20	35	8	6,2	6,8	.0080	○	●	○	●
9	9	1,25	90	20	35	9	7	7,8	.0090				
10	10	1,5	100	22	39	10	8	8,5	.0100	○	●	○	●
12	12	1,75	110	24	44	12	9	10,2	.0112				

DIN 376



» 69

» 69

» 69

» 69

» 69

DIN 352



VA
Stainless steel
materials



ISO 2/6H	ISO 2/6H	ISO 2/6H	ISO 2/6H	ISO 2/6H	ISO 1/4H	ISO 1/4H	ISO 3/6G	ISO 3/6G	7G
TIN	GLT-1	NT		GLT-1	GLT-1	GLT-1	GLT-1	GLT-1	
HSSE	HSSE	HSSE	HSSE	HSSE	HSSE	HSSE	HSSE	HSSE	HSSE
LH	LH		R35	R35	R35	R35	R35	R35	R35
B / 4-5	B / 4-5	B / 4-5	C / 2-3	C / 2-3	C / 2-3	C / 2-3	C / 2-3	C / 2-3	C / 2-3
E / O / P	E / O / P	E / O / P	E / O / P	E / O / P	E / O / P	E / O / P	E / O / P	E / O / P	E / O / P

max. 3 x d₁



max. 2,5 x d₁



P 1.1-4.1	P 1.1-4.1	P 1.1-3.1	P 1.1-3.1	P 1.1-4.1	P 1.1-3.1	P 1.1-4.1	P 1.1-3.1	P 1.1-4.1	P 1.1-3.1
M 1.1-3.1	M 1.1-3.1	M 1.1-2.1	M 1.1-2.1	M 1.1-3.1	M 1.1-2.1	M 1.1-3.1	M 1.1-2.1	M 1.1-3.1	M 1.1-2.1
K 2.1	K 2.1	K 2.1	K 2.1	K 2.1	K 2.1	K 2.1	K 2.1	K 2.1	K 2.1
N 2.2, 2.5-6	N 2.2	N 2.2, 2.5-6							

B0203150	B020C350	B0223000	B0503000	B050C300	B0503010	B050C310	B0503020	B050C320	B0503030
Rekord 1B-VA-LH TIN	Rekord 1B-VA-LH GLT-1	Rekord 1B-VA-AZ NT	Enorm 1-VA	Enorm 1-VA GLT-1	Enorm 1-VA „4H“	Enorm 1-VA GLT-1 „4H“	Enorm 1-VA „6G“	Enorm 1-VA GLT-1 „6G“	Enorm 1-VA „7G“

										M	1
											1,1
											1,2
			○ *)								1,4
			○								1,6
			○								1,7
			○								1,8
	○	●	●	●			●	●			2
			●								2,2
	○	●	●	●			●	●	●		2,3
			●								2,5
	○	○	●	●			●	●	●		2,6
	○	○	●	●	●	●	●	●	●		3
			●								3,5
	○	○	●	●	●	●	●	●	●		4
	○	○	●	●	●	●	●	●	●		4,5
	○	○	●	●	●	●	●	●	●		5
	○	○	●	●	●	●	●	●	●		5,5
	○	○	●	●	●	●	●	●	●		6
	○	○	●	●	●	●	●	●	●		7
	○	○	●	●	●	●	●	●	●		8
	○	○	●	●	●	●	●	●	●		9
	○	○	●	●	●	●	●	●	●		10
			○								12
69	69		70	70	70	70	70	71	71		

*) ≤ M1,4 Tol. 4H/5H

- Product Finder
- Vc
- M
- MF
- UNC UN-8
- UNF UNEF
- G, Rp NPSM, NPSF
- NPT, NPTF Rc, W
- BSW, BSF
- Pg
- MJ UNJC, UNJF
- EG (STI) SELF-LOCK
- Tr, Tr-F Rd
- Zubehör Accessories
- Tech. Info



- Product Finder
- Vc
- M
- MF
- UNC UN-8
- UNF UNEF
- G, Rp NPSM, NPSF
- NPT, NPTF Rc, W
- BSW, BSF
- Pg
- MJ UNJC, UNJF
- EG (STI) SELF-LOCK
- Tr, Tr-F Rd
- Zubehör Accessories
- Tech. Info

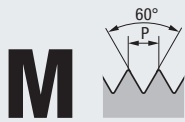

DIN 13

DIN 371

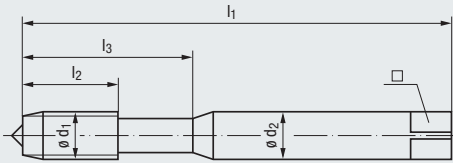

VA
Stainless steel materials



Toleranz · Tolerance
Beschichtung · Coating
Schneidstoff · Cutting material

Technische Informationen
Technical information

» 245 - 266

7G	ISO 2/6H	ISO 2/6H	ISO 2/6H	ISO 2/6H
GLT-1		GLT-1		GLT-1
HSSE	HSSE	HSSE	HSSE	HSSE
R35	LH, L35	LH, L35	R35	R35
C / 2-3	C / 2-3	C / 2-3	C / 2-3	C / 2-3
E / O / P	E / O / P	E / O / P	E / O / P	E / O / P

Gewindetiefe und Lochform
Thread depth and hole type

max. 2,5 x d₁



Einsatzgebiete – Material
Applications – material

» 22

P 1.1-4.1	P 1.1-3.1	P 1.1-4.1	P 1.1-3.1	P 1.1-4.1
M 1.1-3.1	M 1.1-2.1	M 1.1-3.1	M 1.1-2.1	M 1.1-3.1
K 2.1	K 2.1	K 2.1	K 2.1	K 2.1

Werkzeug-Ident · Tool ident

B050C330 B0503050 B050C350 B0603000 B060C300

M	ø d ₁ mm	P mm	l ₁	l ₂	l ₃	ø d ₂	□		Dimens.- Ident	Enorm	Enorm	Enorm	Enorm	Enorm
										1-VA GLT-1 „7G“	1-VA-LH	1-VA-LH GLT-1	1-VA-X	1-VA-X GLT-1
	1	0,25	40	5	–	2,5	2,1	0,75	.0010					
	1,1	0,25	40	5	–	2,5	2,1	0,85	.0011					
	1,2	0,25	40	5	–	2,5	2,1	0,95	.0012					
	1,4	0,3	40	6	–	2,5	2,1	1,1	.0014					
	1,6	0,35	40	6	11	2,5	2,1	1,25	.0016					
	1,7	0,35	40	6	11	2,5	2,1	1,35	.0017					
	1,8	0,35	40	6	11	2,5	2,1	1,45	.0018					
	2	0,4	45	7	12	2,8	2,1	1,6	.0020					
	2,2	0,45	45	7	12	2,8	2,1	1,75	.0022					
	2,3	0,4	45	7	12	2,8	2,1	1,9	.0023					
	2,5	0,45	50	9	14	2,8	2,1	2,05	.0025	•				
	2,6	0,45	50	9	14	2,8	2,1	2,15	.0026					
	3	0,5	56	11	18	3,5	2,7	2,5	.0030	•	•	•	•	•
	3,5	0,6	56	12	20	4	3	2,9	.0035					
	4	0,7	63	13	21	4,5	3,4	3,3	.0040	•	•	•	•	•
	4,5	0,75	70	14	25	6	4,9	3,7	.0045					
	5	0,8	70	15	25	6	4,9	4,2	.0050	•	•	•	•	•
	5,5	0,9	80	16	30	6	4,9	4,6	.0055					
	6	1	80	17	30	6	4,9	5	.0060	•	•	•	•	•
	7	1	80	17	30	7	5,5	6	.0070					
	8	1,25	90	20	35	8	6,2	6,8	.0080	•	•	•	•	•
	9	1,25	90	20	35	9	7	7,8	.0090					
	10	1,5	100	22	39	10	8	8,5	.0100	•	•	•	•	•
	12	1,75	110	24	44	12	9	10,2	.0112					

DIN 376

71 71 71 71 71

DIN 352

GG Cast iron		GJV Cast iron vermicular							
6HX	6HX	6HX	6HX	6HX	6HX	6HX	6HX	6HX	6HX
NT	TICN	TICN	TICN	TICN	TICN	TICN	TICN	TICN	TICN
HSSE	HSSE	HSSE-PM	HSSE-PM	HSSE-PM	HSSE-PM	HSSE-PM	HSSE-PM	HSSE-PM	HSSE-PM
C / 2-3	C / 2-3	C / 2-3	C / 2-3	C / 2-3	E / 1,5-2	E / 1,5-2	E / 1,5-2	E / 1,5-2	E / 1,5-2
E	E	E	E	E	E	E	E	E	E
max. 2 x d ₁ 		max. 2 x d ₁ 		max. 2 x d ₁ 		max. 2 x d ₁ 		max. 2 x d ₁ 	
K 1.1-2	K 1.1-2	K 1.1-4.2	K 1.1-4.2	K 1.1-4.2	K 1.1-4.2	K 1.1-4.2	K 1.1-4.2	K 1.1-4.2	K 1.1-4.2
B0102001	B0109201	B010R501	B195R501	B106R501	B011R501	B196R501	B109R501	B109R501	
Rekord 1A-GG NT	Rekord 1A-GG TICN	Rekord 1A-GJV PM-TICN	Rekord 1A-GJV IKZ-PM TICN	Rekord 1A-GJV IKZN-PM TICN	Rekord 1A-GJV/E PM-TICN	Rekord 1A-GJV/E IKZ-PM TICN	Rekord 1A-GJV/E IKZN-PM TICN	Rekord 1A-GJV/E IKZN-PM TICN	
									M 1
									1,1
									1,2
									1,4
									1,6
									1,7
									1,8
									2
									2,2
									2,3
									2,5
									2,6
●									3
●	●	●	○		●	○			3,5
									4
●	●	●	●	○	●	●	○		4,5
									5
●	●	●	●	○	●	●	○		5,5
									6
●	●	●	●	○	●	●	○		7
									8
●	●	●	●	○	●	●	○		9
									10
									12
71	71	72	72	72	72	72	72	73	

1) Gewindebohren in Durchgangslöcher nur mit externer Kühlschmierung möglich
Threading in through holes is possible only with external cooling/lubrication

Product Finder

V_c

M

MF

UNC UN-8

UNF UNEF

G, Rp NPSM, NPSF

NPT, NPTF Rc, W

BSW, BSF

Pg

MJ UNJC, UNJF

EG (ST) SELF-LOCK

Tr, Tr-F Rd

Zubehör Accessories

Tech. Info



- Product Finder
- V_c
- M
- MF
- UNC UN-8
- UNF UNEF
- G, Rp NPSM, NPSF
- NPT, NPTF Rc, W
- BSW, BSF
- Pg
- MJ UNJC, UNJF
- EG (STI) SELF-LOCK
- Tr, Tr-F Rd
- Zubehör Accessories
- Tech. Info

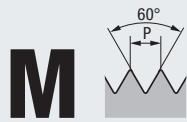

DIN 13

DIN 371

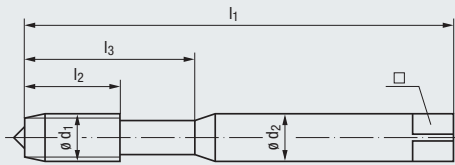

AL
Aluminium wrought alloys



Technische Informationen Technical information ▶ 245 - 266	Toleranz · Tolerance	ISO 2/6H	ISO 2/6H	ISO 2/6H	ISO 2/6H	ISO 2/6H
	Beschichtung · Coating	HSSE	GLT-8	HSSE	GLT-8	GLT-8
	Schneidstoff · Cutting material	HSSE	HSSE	HSSE	HSSE	HSSE
		B / ≈3	B / ≈3	C / 2-3	C / 2-3	E / 1,5-2
		E / O	E / O	E / O	E / O	E / O

Gewindetiefe und Lochform Thread depth and hole type	max. 3 x d ₁	max. 2,5 x d ₁			

Einsatzgebiete – Material Applications – material ▶ 22	N 1.1-4	N 1.1-4	N 1.1-4	N 1.1-4	N 1.1-4
--	---------	---------	---------	---------	---------

Werkzeug-Ident · Tool ident										B0204500	B020S800	B0504500	B050S800	B051S800
M	d ₁ mm	P mm	l ₁	l ₂	l ₃	d ₂	□		Dimens.-Ident	Rekord 1B-AL	Rekord 1B-AL GLT-8	Enorm 1-AL	Enorm 1-AL GLT-8	Enorm 1-AL/E GLT-8
										1	0,25	40	5	–
1,1	0,25	40	5	–	2,5	2,1	0,85	.0011						
1,2	0,25	40	5	–	2,5	2,1	0,95	.0012						
1,4	0,3	40	6	–	2,5	2,1	1,1	.0014	● ^{*)}	● ^{*)}	● ^{*)}	● ^{*)}		
1,6	0,35	40	6	11	2,5	2,1	1,25	.0016	●	●	●	●		
1,7	0,35	40	6	11	2,5	2,1	1,35	.0017						
1,8	0,35	40	6	11	2,5	2,1	1,45	.0018						
2	0,4	45	7	12	2,8	2,1	1,6	.0020	●	●	●	●		
2,2	0,45	45	7	12	2,8	2,1	1,75	.0022						
2,3	0,4	45	7	12	2,8	2,1	1,9	.0023						
2,5	0,45	50	9	14	2,8	2,1	2,05	.0025	●	●	●	●		
2,6	0,45	50	9	14	2,8	2,1	2,15	.0026						
3	0,5	56	11	18	3,5	2,7	2,5	.0030	●	●	●	●	●	
3,5	0,6	56	12	20	4	3	2,9	.0035	○	○	○	○		
4	0,7	63	13	21	4,5	3,4	3,3	.0040	●	●	●	●	●	
4,5	0,75	70	14	25	6	4,9	3,7	.0045						
5	0,8	70	15	25	6	4,9	4,2	.0050	●	●	●	●	●	
5,5	0,9	80	16	30	6	4,9	4,6	.0055						
6	1	80	17	30	6	4,9	5	.0060	●	●	●	●	●	
7	1	80	17	30	7	5,5	6	.0070						
8	1,25	90	20	35	8	6,2	6,8	.0080	●	●	●	●	●	
9	1,25	90	20	35	9	7	7,8	.0090						
10	1,5	100	22	39	10	8	8,5	.0100	●	●	●	●	●	
12	1,75	110	24	44	12	9	10,2	.0112						

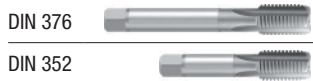

^{*)} ≤ M1,4 Tol. 4H/5H

- Product Finder
- V_c
- M
- MF
- UNC UN-8
- UNF UNEF
- G, Rp NPSM, NPSF
- NPT, NPTF Rc, W
- BSW, BSF
- Pg
- MJ UNJC, UNJF
- EG (STI) SELF-LOCK
- Tr, Tr-F Rd
- Zubehör Accessories
- Tech. Info

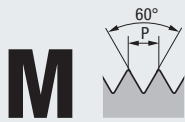

M
DIN 13

DIN 371

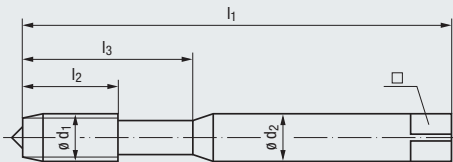

PVC
Long-chipping synthetics



MS
Copper-zinc alloys



TI
Titanium



Toleranz · Tolerance
Beschichtung · Coating
Schneidstoff · Cutting material

Technische Informationen
Technical information

» 245 - 266



- 6HX
- CRN
- HSSE
- R15
- E / 1,5-2**
- E

- 6HX
- HSSE
- C / 2-3
- E

- 6HX
- NT2
- HSSE
- L15
- D / 4-5
- E / O / P

Gewindetiefe und Lochform
Thread depth and hole type

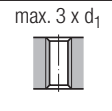
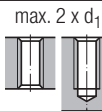
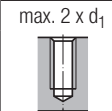

Einsatzgebiete – Material
Applications – material

» 22

N 4.2

N 2.3

- P 4.1-5.1**
- M 3.1-4.1**
- N 2.4-5, 2.7**
- S 1.1-2.2, 2.4**

Werkzeug-Ident · Tool ident

B046L801

B0102501

B0306001



















M	ø d ₁ mm	P mm	l ₁	l ₂	l ₃	ø d ₂	□	Image	Dimens.-Ident	Rekord 1D-PVC/E CRN	Rekord 1A-MS	Rekord 1C-TI NT2
	1	0,25	40	5	–	2,5	2,1	0,75	.0010			
	1,1	0,25	40	5	–	2,5	2,1	0,85	.0011			
	1,2	0,25	40	5	–	2,5	2,1	0,95	.0012			
	1,4	0,3	40	6	–	2,5	2,1	1,1	.0014			
	1,6	0,35	40	6	11	2,5	2,1	1,25	.0016			
	1,7	0,35	40	6	11	2,5	2,1	1,35	.0017			
	1,8	0,35	40	6	11	2,5	2,1	1,45	.0018			
	2	0,4	45	7	12	2,8	2,1	1,6	.0020		●	●
	2,2	0,45	45	7	12	2,8	2,1	1,75	.0022			
	2,3	0,4	45	7	12	2,8	2,1	1,9	.0023			
	2,5	0,45	50	9	14	2,8	2,1	2,05	.0025		●	●
	2,6	0,45	50	9	14	2,8	2,1	2,15	.0026			
	3	0,5	56	11	18	3,5	2,7	2,5	.0030	●	●	●
	3,5	0,6	56	12	20	4	3	2,9	.0035			○
	4	0,7	63	13	21	4,5	3,4	3,3	.0040	●	●	●
	4,5	0,75	70	14	25	6	4,9	3,7	.0045			
	5	0,8	70	15	25	6	4,9	4,2	.0050	●	●	●
	5,5	0,9	80	16	30	6	4,9	4,6	.0055			
	6	1	80	17	30	6	4,9	5	.0060	●	●	●
	7	1	80	17	30	7	5,5	6	.0070			
	8	1,25	90	20	35	8	6,2	6,8	.0080	●	●	●
	9	1,25	90	20	35	9	7	7,8	.0090			
	10	1,5	100	22	39	10	8	8,5	.0100	●	●	●
	12	1,75	110	24	44	12	9	10,2	.0112			

DIN 376

DIN 352

» 73

» 91

TI Titanium			TILEG Titanium alloys	NI Nickel alloys		H Materials of high tensile strength
						
6HX	6HX	6HX	6HX	6HX	6HX	6HX
TICN	NT2	TICN	TICN	TICN	TICN	NT
HSSE	HSSE	HSSE	HSSE	HSSE-PM	HSSE-PM	HSSE
L15	R15	R15	R15	L08	R10	
D / 4-5	C / 2-3	C / 2-3	C / 2-3	D / 4-5	C / 2-3	C / 2-3
E / O / P	E / O / P	E / O / P	E / O / P	O / P	O / P	E / O / P
max. 3 x d ₁ 	max. 2 x d ₁ 		max. 2 x d ₁ 	max. 3 x d ₁ 	max. 2 x d ₁ 	max. 2 x d ₁ 
P 4.1-5.1 M 3.1-4.1 N 2.4-5, 2.7 S 1.1-2.2, 2.4	P 4.1-5.1 M 3.1-4.1 N 2.4-5, 2.7 S 1.1-2.2, 2.4	P 4.1-5.1 M 3.1-4.1 N 2.4-5, 2.7 S 1.1-2.2, 2.4	M 4.1 S 1.2-3	M 4.1 N 2.8 S 1.2-3 S 2.3, 2.5-6	M 4.1 N 2.8 S 1.2-3 S 2.3, 2.5-6	P 1.1-3.1 K 1.1-4.2 N 2.4-7 N 4.1, 5.1
B0309601	B0456001	B0459601	B040V401	B030J401	B438J401	B0100501
Rekord 1C-TI TICN	Rekord 1D-TI NT2	Rekord 1D-TI TICN	Rekord 1DF-TILEG TICN	Rekord 1C-NI-PM TICN	Rekord 1DF-NI-PM TICN	Rekord 1A-H NT
						M 1
						1,1
						1,2
						1,4
						1,6
						1,7
						1,8
●	●	●				2
						2,2
●	●	●				2,3
						2,5
●	●	●	●	●	●	2,6
						3
○	○	○				3,5
●	●	●	●	●	●	4
						4,5
●	●	●	●	●	●	5
						5,5
●	●	●	●	●	●	6
						7
●	●	●	●	●	●	8
						9
●	●	●	●	●	●	10
						12
						

- Product Finder
- V_c
- M
- MF
- UNC UN-8
- UNF
- G, Rp NPSM, NPSF
- NPT, NPTF Rc, W
- BSW, BSF
- Pg
- MJ UNJC, UNJF
- EG (STI) SELF-LOCK
- Tr, Tr-F Rd
- Zubehör Accessories
- Tech. Info

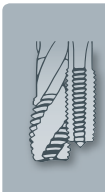

- Product Finder
- V_c
- M
- MF
- UNC UN-8
- UNF UNEF
- G, Rp NPSM, NPSF
- NPT, NPTF Rc, W
- BSW, BSF
- Pg
- MJ UNJC, UNJF
- EG (STI) SELF-LOCK
- Tr, Tr-F Rd
- Zubehör Accessories
- Tech. Info

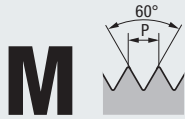

DIN 13

DIN 371

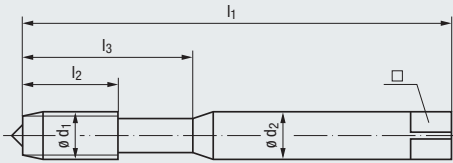

H
Materials of high tensile strength



Toleranz · Tolerance
Beschichtung · Coating
Schneidstoff · Cutting material

Technische Informationen
Technical information

» 245 - 266



6HX	6HX	6HX	6HX	6HX
TICN	NT	TICN	TICN	
HSSE	HSSE	HSSE	HSSE	VHM
C / 2-3	C / 2-3	C / 2-3	C / 2-3	C / 2-3
E / O / P	E / O	E / O	E / O	E / O

Gewindetiefe und Lochform
Thread depth and hole type

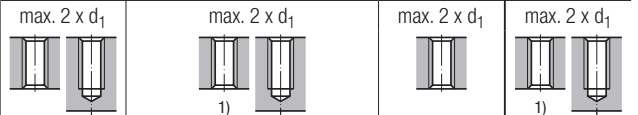

Einsatzgebiete – Material
Applications – material

» 22

P 1.1-4.1	P 1.1-3.1	P 1.1-4.1	P 1.1-4.1	P 5.1
K 1.1-4.2	K 1.1-4.2	K 1.1-4.2	K 1.1-4.2	K 1.1-4.2
N 2.4-7	N 2.4-7	N 2.4-7	N 2.4-7	N 1.5-6, 2.6-8
N 4.1, 5.1	N 4.1, 5.1	N 4.1, 5.1	N 4.1, 5.1	N 4.1, 4.3-5.2
				H 1.1-2

Werkzeug-Ident · Tool ident

B0109101 B1950501 B1959101 B1069101 B1950901

M	Ø d ₁ mm	P mm	l ₁	l ₂	l ₃	Ø d ₂	□	Dimens.- Ident	Rekord 1A-H TICN	Rekord 1A-H-IKZ NT	Rekord 1A-H-IKZ TICN	Rekord 1A-H-IKZN TICN	VHM Rekord 1A-H-IKZ
1	1	0,25	40	5	–	2,5	2,1	0,75					
1,1	1,1	0,25	40	5	–	2,5	2,1	0,85					
1,2	1,2	0,25	40	5	–	2,5	2,1	0,95					
1,4	1,4	0,3	40	6	–	2,5	2,1	1,1					
1,6	1,6	0,35	40	6	11	2,5	2,1	1,25					
1,7	1,7	0,35	40	6	11	2,5	2,1	1,35					
1,8	1,8	0,35	40	6	11	2,5	2,1	1,45					
2	2	0,4	45	7	12	2,8	2,1	1,6	●				
2,2	2,2	0,45	45	7	12	2,8	2,1	1,75					
2,3	2,3	0,4	45	7	12	2,8	2,1	1,9					
2,5	2,5	0,45	50	9	14	2,8	2,1	2,05	●				
2,6	2,6	0,45	50	9	14	2,8	2,1	2,15					
3	3	0,5	56	11	18	3,5	2,7	2,5	●				●
3,5	3,5	0,6	56	12	20	4	3	2,9	●				●
4	4	0,7	63	13	21	4,5	3,4	3,3 ²⁾	●				●
4,5	4,5	0,75	70	14	25	6	4,9	3,7					
5	5	0,8	70	15	25	6	4,9	4,2 ²⁾	●	●	●	○	●
5,5	5,5	0,9	80	16	30	6	4,9	4,6					
6	6	1	80	17	30	6	4,9	5 ²⁾	●	●	●	○	●
7	7	1	80	17	30	7	5,5	6	●				
8	8	1,25	90	20	35	8	6,2	6,8 ²⁾	●	●	●	○	●
9	9	1,25	90	20	35	9	7	7,8					
10	10	1,5	100	22	39	10	8	8,5 ²⁾	●	●	●	○	●
12	12	1,75	110	24	44	12	9	10,2					



» 75 » 75 » 75 » 75 » 75

1) Gewindebohren in Durchgangslöcher nur mit externer Kühlschmierung möglich
Threading in through holes is possible only with external cooling/lubrication

M



DIN 13

DIN 371

HCUT
Hardened steels

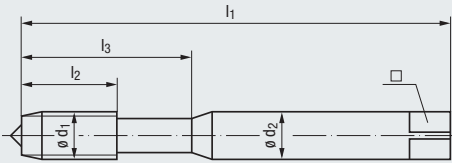

Technische Informationen
Technical information

» 245 - 266

Toleranz · Tolerance
Beschichtung · Coating
Schneidstoff · Cutting material



6HX

TICN

HSSE-PM

C / 2-3

O / P

Gewindetiefe und Lochform
Thread depth and hole type

max. 1,5 x d₁

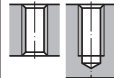

Einsatzgebiete – Material
Applications – material

» 22

H 1.1-2

Werkzeug-Ident · Tool ident

B010J901

M	ø d ₁ mm	P mm	l ₁	l ₂	l ₃	ø d ₂	□		Dimens.-Ident	Rekord 1A-HCUT-PM TICN		
										○	●	●
	4	0,7	63	7	21	4,5	3,4	3,4	.0040	○		
	5	0,8	70	8	25	6	4,9	4,3	.0050	○		
	6	1	80	10	30	6	4,9	5,1	.0060	●		
	8	1,25	90	14	35	8	6,2	6,9	.0080	●		
	10	1,5	100	16	39	10	8	8,6	.0100	●		

DIN 376



» 75

DIN 352



Product Finder

V_c

M

MF

UNC UN-8

UNF UNEF

G, Rp NPSM, NPSF

NPT, NPTF Rc, W

BSW, BSF

Pg

MJ UNJC, UNJF

EG (ST) SELF-LOCK

Tr, Tr-F Rd

Zubehör Accessories

Tech. Info



Werkzeug-Aufnahmen der Typenreihe Softsynchro® siehe Seite 661 - 681

Tool holders of our Softsynchro® series, see page 661 - 681

- Product Finder
- V_c
- M
- MF
- UNC UN-8
- UNF UNEF
- G, Rp NPSM, NPSF
- NPT, NPTF Rc, W
- BSW, BSF
- Pg
- MJ UNJC, UNJF
- EG (STI) SELF-LOCK
- Tr, Tr-F Rd
- Zubehör Accessories
- Tech. Info

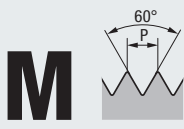

DIN 13

≈DIN 371

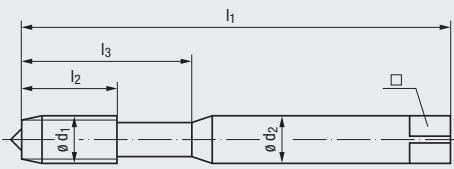

HCUT
Hardened steels



Toleranz · Tolerance
Beschichtung · Coating
Schneidstoff · Cutting material

Technische Informationen
Technical information

Technical information → 245 - 266

6HX	6HX
TICN	TICN
VHM	VHM
D / 4-5	C / 2-3
O / P	O / P

Gewindetiefe und Lochform
Thread depth and hole type

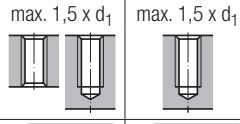

Einsatzgebiete – Material
Applications – material

Applications – material → 22

H 1.3-4	H 1.3-4
---------	---------

Werkzeug-Ident · Tool ident

B016K101 B010K101

M	ø d ₁ mm	P mm	l ₁	l ₂	l ₃	ø d ₂	□	2,55	Dimens.- Ident	VHM Rekord	
										1A-HCUT/D TICN	1A-HCUT/C TICN
	3	0,5	63	6	18	4,5	3,4	2,55	.0030	●	●
	4	0,7	63	8	20	4,5	3,4	3,4	.0040	●	●
	5	0,8	70	10	26	6	4,9	4,3	.0050	●	●
	6	1	80	12	28	6	4,9	5,1	.0060	●	●
	8	1,25	90	15	35	8	6,2	6,9	.0080	●	●
	10	1,5	100	18	38	10	8	8,6	.0100	●	●
	12	1,75	110	21	41	12	9	10,4	.0112	●	●
	14	2	110	24	44	14	11	12,2	.0114	○	○
	16	2	110	24	44	16	12	14,2	.0116	●	●

2) Achtung: VHM-Rekord 1A-HCUT/D-TICN als Vorschneider verwenden!
Please note: Use solid carbide tap VHM-Rekord 1A-HCUT/D-TICN as No.1 tap!



Spiralbohrer Typ EF-Drill-HCUT
siehe Seite 558

Twist drills type EF-Drill-HCUT,
see page 558

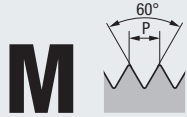

DIN 13

DIN 371

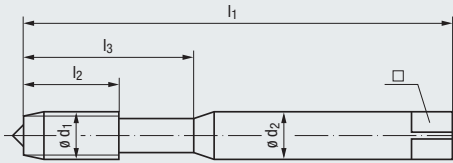

Technische Informationen
Technical information

» 245 - 266

Toleranz · Tolerance
Beschichtung · Coating
Schneidstoff · Cutting material



Gewindetiefe und Lochform
Thread depth and hole type

Einsatzgebiete – Material
Applications – material

» 22

Werkzeug-Ident · Tool ident

M	ø d ₁ mm	P mm	l ₁	l ₂	l ₃	ø d ₂	□	Dimens.- Ident	Z CNC-controlled machines					
									Rekord 1A-Z TICN	Rekord 1A-Z- IKZ TICN	Rekord 1A-Z- IKZN TICN	Rekord 1A-Z/ E TICN	Rekord 1A-Z- E- IKZ TICN	
	1	0,25	40	2,5	–	2,5	2,1	0,75						
	1,1	0,25	40	2,5	–	2,5	2,1	0,85						
	1,2	0,25	40	2,5	–	2,5	2,1	0,95						
	1,4	0,3	40	3	–	2,5	2,1	1,1						
	1,6	0,35	40	4	11	2,5	2,1	1,25						
	1,7	0,35	40	4	11	2,5	2,1	1,35						
	1,8	0,35	40	4	11	2,5	2,1	1,45						
	2	0,4	45	4	12	2,8	2,1	1,6						
	2,2	0,45	45	4,5	12	2,8	2,1	1,75						
	2,3	0,4	45	4,5	12	2,8	2,1	1,9						
	2,5	0,45	50	5	14	2,8	2,1	2,05						
	2,6	0,45	50	5	14	2,8	2,1	2,15						
	3	0,5	56	6	18	3,5	2,7	2,5						
	3,5	0,6	56	7	20	4	3	2,9						
	4	0,7	63	7	21	4,5	3,4	3,3						
	4,5	0,75	70	8	25	6	4,9	3,7						
	5	0,8	70	8	25	6	4,9	4,2						
	5,5	0,9	80	10	30	6	4,9	4,6						
	6	1	80	10	30	6	4,9	5						
	7	1	80	10	30	7	5,5	6						
	8	1,25	90	14	35	8	6,2	6,8						
	9	1,25	90	14	35	9	7	7,8						
	10	1,5	100	16	39	10	8	8,5						
	12	1,75	110	18	44	12	9	10,2						

DIN 376



» 76

» 76

» 76

» 76

» 76

DIN 352



1) Gewindebohren in Durchgangslöcher nur mit externer Kühlschmierung möglich
Threading in through holes is possible only with external cooling/lubrication

Product Finder

- Vc
- M
- MF
- UNC UN-8
- UNF
- G, Rp NPSM, NPSF
- NPT, NPTF Rc, W
- BSW, BSF
- Pg
- MJ UNJC, UNJF
- EG (ST) SELF-LOCK
- Tr, Tr-F Rd
- Zubehör Accessories
- Tech. Info

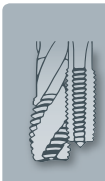

- Product Finder
- V_c
- M
- MF
- UNC UN-8
- UNF UNEF
- G, Rp NPSM, NPSF
- NPT, NPTF Rc, W
- BSW, BSF
- Pg
- MJ UNJC, UNJF
- EG (STI) SELF-LOCK
- Tr, Tr-F Rd
- Zubehör Accessories
- Tech. Info

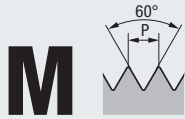

DIN 13

DIN 371

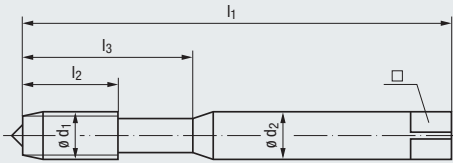

Toleranz · Tolerance
Beschichtung · Coating
Schneidstoff · Cutting material

Technische Informationen
Technical information

Technical information 245 - 266

Gewindetiefe und Lochform
Thread depth and hole type

Einsatzgebiete – Material
Applications – material

Werkzeug-Ident · Tool ident

M	ø d ₁ mm	P mm	l ₁	l ₂	l ₃	ø d ₂	□	Dimens.- Ident						
									Rekord 1A-Z/E- IKZN TICN	Rekord 1B-Z-PM TIN-70	Rekord 1B-Z-PM GLT-1	Rekord 1B-Z- IKZN PM-TIN-70	Rekord 1B-Z- IKZN PM-GLT-1	
	1	0,25	40	2,5	–	2,5	2,1	0,75	.0010					
	1,1	0,25	40	2,5	–	2,5	2,1	0,85	.0011					
	1,2	0,25	40	2,5	–	2,5	2,1	0,95	.0012					
	1,4	0,3	40	3	–	2,5	2,1	1,1	.0014					
	1,6	0,35	40	4	11	2,5	2,1	1,25	.0016					
	1,7	0,35	40	4	11	2,5	2,1	1,35	.0017					
	1,8	0,35	40	4	11	2,5	2,1	1,45	.0018					
	2	0,4	45	4	12	2,8	2,1	1,6	.0020		●	●		
	2,2	0,45	45	4,5	12	2,8	2,1	1,75	.0022					
	2,3	0,4	45	4,5	12	2,8	2,1	1,9	.0023					
	2,5	0,45	50	5	14	2,8	2,1	2,05	.0025		●	●		
	2,6	0,45	50	5	14	2,8	2,1	2,15	.0026					
	3	0,5	56	6	18	3,5	2,7	2,5	.0030		●	●		
	3,5	0,6	56	7	20	4	3	2,9	.0035		●	●		
	4	0,7	63	7	21	4,5	3,4	3,3	.0040		●	●		
	4,5	0,75	70	8	25	6	4,9	3,7	.0045					
	5	0,8	70	8	25	6	4,9	4,2	.0050	○	●	●	○	○
	5,5	0,9	80	10	30	6	4,9	4,6	.0055					
	6	1	80	10	30	6	4,9	5	.0060	○	●	●	○	○
	7	1	80	10	30	7	5,5	6	.0070					
	8	1,25	90	14	35	8	6,2	6,8	.0080	○	●	●	○	○
	9	1,25	90	14	35	9	7	7,8	.0090					
	10	1,5	100	16	39	10	8	8,5	.0100	○	●	●	○	○
	12	1,75	110	18	44	12	9	10,2	.0112					

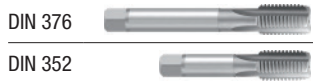

Z CNC-controlled machines				
6HX	6HX	6HX	6HX	6HX
TICN	TIN-70	GLT-1	TIN-70	GLT-1
HSSE	HSSE-PM	HSSE-PM	HSSE-PM	HSSE-PM
E / 1,5-2	B / 4-5	B / 4-5	B / 4-5	B / 4-5
E / O	E / O / P	E / O / P	E / O	E / O
max. 2 x d ₁	max. 3 x d ₁			
P 1.1-4.1	P 1.1-5.1	P 1.1-5.1	P 1.1-5.1	P 1.1-5.1
K 1.1-4.2	M 1.1-3.1	M 1.1-3.1	M 1.1-3.1	M 1.1-3.1
N 1.4-6, 2.4-7	K 2.1	K 2.1	K 2.1	K 2.1
N 4.1	N 1.4-2.2, 2.4-5	N 1.4-2.2, 2.4-5	N 1.4-2.2, 2.4-5	N 1.4-2.2, 2.4-5
S 1.1	S 1.1	S 1.1	S 1.1	S 1.1
B1099401	B0208F01	B020A601	B1088F01	B108A601
Rekord 1A-Z/E- IKZN TICN	Rekord 1B-Z-PM TIN-70	Rekord 1B-Z-PM GLT-1	Rekord 1B-Z- IKZN PM-TIN-70	Rekord 1B-Z- IKZN PM-GLT-1
77	77	77	77	77
DIN 352				

Z CNC-controlled machines									
new	new	new	new			new	new	new	new
6GX	6GX	6GX	6GX	6HX	6HX	6HX	6HX	6HX	6HX
TIN-70	GLT-1	TIN-70	GLT-1	TIN	TIN	TIN	TIN	TIN	TIN
HSSE-PM	HSSE-PM	HSSE-PM	HSSE-PM	HSSE	HSSE	HSSE	HSSE	HSSE	HSSE
R15	R15	R15	R15	R15	R15	R15	R15	R15	R15
B / 4-5	B / 4-5	B / 4-5	B / 4-5	C / 2-3	C / 2-3	E / 1,5-2	C / 2-3	E / 1,5-2	C / 2-3
E / O / P	E / O / P	E / O	E / O	E / O / P	E / O	E / O	E / O	E / O	E / O
max. 3 x d ₁ 				max. 2 x d ₁ 					
P 1.1-5.1	P 1.1-5.1	P 1.1-5.1	P 1.1-5.1	P 2.1-5.1	P 2.1-5.1	P 2.1-5.1	P 2.1-5.1	P 2.1-5.1	P 2.1-5.1
M 1.1-3.1	M 1.1-3.1	M 1.1-3.1	M 1.1-3.1	K 2.1-2	K 2.1-2	K 2.1-2	K 2.1-2	K 2.1-2	K 2.1-2
N 1.4-2.2, 2.4-5	N 1.4-2.2, 2.4-5	N 1.4-2.2, 2.4-5	N 1.4-2.2, 2.4-5	N 1.4-6, 2.4-5	N 1.4-6, 2.4-5	N 1.4-6, 2.4-5	N 1.4-6, 2.4-5	N 1.4-6, 2.4-5	N 1.4-6, 2.4-5
S 1.1	S 1.1	S 1.1	S 1.1						
B0208F21	B020A621	B1088F21	B108A621	B0453701	B0963701	B0983701	B4253701	B4053701	
Rekord 1B-Z-PM TIN-70 „6GX“	Rekord 1B-Z-PM GLT-1 „6GX“	Rekord 1B-Z-1KZN PM-TIN-70 „6GX“	Rekord 1B-Z-1KZN PM-GLT-1 „6GX“	Rekord 1D-Z TIN	Rekord 1D-Z-1KZ TIN	Rekord 1D-Z/E-1KZ TIN	Rekord 1D-Z-BF 1KZ-TIN	Rekord 1D-Z/E-BF 1KZ-TIN	
									M
									1
									1,1
									1,2
									1,4
									1,6
									1,7
									1,8
●	●								2
									2,2
●	●								2,3
									2,5
●	●			●					2,6
									3
●	●			●	●				3,5
									4
●	●	○	○	●	●	●	●	●	4,5
									5
●	●	○	○	●	●	●	●	●	5,5
									6
●	●	○	○	●	●	●	●	●	7
									8
●	●	○	○	●	●	●	●	●	9
									10
									12

- Product Finder
- V_c
- M
- MF
- UNC UN-8
- UNF UNEF
- G, Rp NPSM, NPSF
- NPT, NPTF Rc, W
- BSW, BSF
- Pg
- MJ UNJC, UNJF
- EG (ST) SELF-LOCK
- Tr, Tr-F Rd
- Zubehör Accessories
- Tech. Info

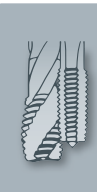

● = Lagerwerkzeug, siehe Preisliste · Stock tool, see price list
 ○ = Kurzfristig lieferbar, Preis auf Anfrage · Available on short notice, price upon inquiry

- Product Finder
- V_c
- M
- MF
- UNC UN-8
- UNF UNEF
- G, Rp NPSM, NPSF
- NPT, NPTF Rc, W
- BSW, BSF
- Pg
- MJ UNJC, UNJF
- EG (STI) SELF-LOCK
- Tr, Tr-F Rd
- Zubehör Accessories
- Tech. Info

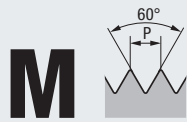

DIN 13

DIN 371

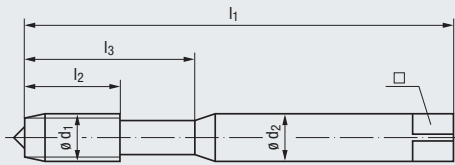

Toleranz · Tolerance
Beschichtung · Coating
Schneidstoff · Cutting material

Technische Informationen
Technical information

» 245 - 266



Z
CNC-controlled machines



6HX	6HX	6HX	6HX	6HX
TIN-60	GLT-1	TIN-60	GLT-1	TIN-60
HSSE-PM	HSSE-PM	HSSE-PM	HSSE-PM	HSSE-PM
R45	R45	R45	R45	R45
C / 2-3	C / 2-3	C / 2-3	C / 2-3	E / 1,5-2
E / O / P	E / O / P	E / O	E / O	E / O / P

Gewindetiefe und Lochform
Thread depth and hole type

max. 3 x d₁



Einsatzgebiete – Material
Applications – material

» 22

P 2.1-4.1	P 2.1-4.1	P 2.1-4.1	P 2.1-4.1	P 2.1-4.1
M 1.1-3.1	M 1.1-3.1	M 1.1-3.1	M 1.1-3.1	M 1.1-3.1
K 2.1	K 2.1	K 2.1	K 2.1	K 2.1
N 1.4-2.2, 2.4-5	N 1.4-2.2, 2.4-5	N 1.4-2.2, 2.4-5	N 1.4-2.2, 2.4-5	N 1.4-2.2, 2.4-5
S 1.1	S 1.1	S 1.1	S 1.1	S 1.1

Werkzeug-Ident · Tool ident

M	ø d ₁ mm	P mm	l ₁	l ₂	l ₃	ø d ₂	□	Dimens.- Ident	B5760F01	B576A601	B5810F01	B581A601	B5820F01
									Enorm 1-Z-X-PM TIN-60	Enorm 1-Z-X-PM GLT-1	Enorm 1-Z-X IKZ-PM TIN-60	Enorm 1-Z-X IKZ-PM GLT-1	Enorm 1-Z/E-X-PM TIN-60
1	1	0,25	40	2,5	–	2,5	2,1	0,75					
1,1	1,1	0,25	40	2,5	–	2,5	2,1	0,85					
1,2	1,2	0,25	40	2,5	–	2,5	2,1	0,95					
1,4	1,4	0,3	40	3	–	2,5	2,1	1,1					
1,6	1,6	0,35	40	4	11	2,5	2,1	1,25					
1,7	1,7	0,35	40	4	11	2,5	2,1	1,35					
1,8	1,8	0,35	40	4	11	2,5	2,1	1,45					
2	2	0,4	45	4	12	2,8	2,1	1,6	○	○			○
2,2	2,2	0,45	45	4,5	12	2,8	2,1	1,75					
2,3	2,3	0,4	45	4,5	12	2,8	2,1	1,9					
2,5	2,5	0,45	50	5	14	2,8	2,1	2,05	○	○			○
2,6	2,6	0,45	50	5	14	2,8	2,1	2,15					
3	3	0,5	56	6	18	3,5	2,7	2,5	●	●			●
3,5	3,5	0,6	56	7	20	4	3	2,9	○	○			○
4	4	0,7	63	7	21	4,5	3,4	3,3	●	●	●	●	●
4,5	4,5	0,75	70	8	25	6	4,9	3,7			●	●	●
5	5	0,8	70	8	25	6	4,9	4,2	●	●	●	●	●
5,5	5,5	0,9	80	10	30	6	4,9	4,6			●	●	●
6	6	1	80	10	30	6	4,9	5	●	●	●	●	●
7	7	1	80	10	30	7	5,5	6			●	●	●
8	8	1,25	90	14	35	8	6,2	6,8	●	●	●	●	●
9	9	1,25	90	14	35	9	7	7,8			●	●	●
10	10	1,5	100	16	39	10	8	8,5	●	●	●	●	●
12	12	1,75	110	18	44	12	9	10,2					

DIN 376



» 79

» 79

» 79

» 79

» 79

DIN 352



Z
CNC-controlled
machines

new	new	new	new	new	new	new	new	new	new
6HX	6HX	6HX	6GX	6GX	6GX	6GX	6GX	6GX	6GX
GLT-1	TIN-60	GLT-1	TIN-60	GLT-1	TIN-60	GLT-1	TIN-60	GLT-1	TIN-60
HSSE-PM	HSSE-PM	HSSE-PM	HSSE-PM	HSSE-PM	HSSE-PM	HSSE-PM	HSSE-PM	HSSE-PM	HSSE-PM
R45	R45	R45	R45	R45	R45	R45	R45	R45	R45
E / 1,5-2	E / 1,5-2	E / 1,5-2	C / 2-3	C / 2-3	C / 2-3	C / 2-3	E / 1,5-2	E / 1,5-2	E / 1,5-2
E / O / P	E / O	E / O	E / O / P	E / O / P	E / O	E / O	E / O / P	E / O / P	E / O

max. 3 x d₁



P 2.1-4.1	P 2.1-4.1	P 2.1-4.1	P 2.1-4.1	P 2.1-4.1	P 2.1-4.1	P 2.1-4.1	P 2.1-4.1	P 2.1-4.1	P 2.1-4.1	P 2.1-4.1
M 1.1-3.1	M 1.1-3.1	M 1.1-3.1	M 1.1-3.1	M 1.1-3.1	M 1.1-3.1	M 1.1-3.1	M 1.1-3.1	M 1.1-3.1	M 1.1-3.1	M 1.1-3.1
K 2.1	K 2.1	K 2.1	K 2.1	K 2.1	K 2.1	K 2.1	K 2.1	K 2.1	K 2.1	K 2.1
N 1.4-2.2, 2.4-5	N 1.4-2.2, 2.4-5	N 1.4-2.2, 2.4-5	N 1.4-2.2, 2.4-5	N 1.4-2.2, 2.4-5	N 1.4-2.2, 2.4-5	N 1.4-2.2, 2.4-5	N 1.4-2.2, 2.4-5	N 1.4-2.2, 2.4-5	N 1.4-2.2, 2.4-5	N 1.4-2.2, 2.4-5
S 1.1	S 1.1	S 1.1	S 1.1	S 1.1	S 1.1	S 1.1	S 1.1	S 1.1	S 1.1	S 1.1
B582A601	B5830F01	B583A601	B5760F21	B576A621	B5810F21	B581A621	B5820F21	B582A621	B5830F21	
Enorm 1-Z/E-X-PM GLT-1	Enorm 1-Z/E-X IKZ-PM TIN-60	Enorm 1-Z/E-X IKZ-PM GLT-1	Enorm 1-Z-X-PM TIN-60 „6GX“	Enorm 1-Z-X-PM GLT-1 „6GX“	Enorm 1-Z-X-IKZ PM-TIN-60 „6GX“	Enorm 1-Z-X-IKZ PM-GLT-1 „6GX“	Enorm 1-Z/E-X-PM TIN-60 „6GX“	Enorm 1-Z/E-X-PM GLT-1 „6GX“	Enorm 1-Z/E-X-IKZ PM-TIN-60 „6GX“	
										M 1
										1,1
										1,2
										1,4
										1,6
										1,7
										1,8
○										2
										2,2
○										2,3
										2,5
										2,6
●			●	●			●	●		3
○										3,5
●	●	●	●	●	●	●	●	●	●	4
										4,5
●	●	●	●	●	●	●	●	●	●	5
										5,5
●	●	●	●	●	●	●	●	●	●	6
										7
●	●	●	●	●	●	●	●	●	●	8
										9
●	●	●	●	●	●	●	●	●	●	10
										12
79	79	79	79	79	80	80	80	80	80	

- Product Finder
- V_c
- M
- MF
- UNC UN-8
- UNF UNEF
- G, Rp NPSM, NPSF
- NPT, NPTF Rc, W
- BSW, BSF
- Pg
- MJ UNJC, UNJF
- EG (ST) SELF-LOCK
- Tr, Tr-F Rd
- Zubehör Accessories
- Tech. Info



● = Lagerwerkzeug, siehe Preisliste · Stock tool, see price list
○ = Kurzfristig lieferbar, Preis auf Anfrage · Available on short notice, price upon inquiry

- Product Finder
- V_c
- M
- MF
- UNC UN-8
- UNF UNEF
- G, Rp NPSM, NPSF
- NPT, NPTF Rc, W
- BSW, BSF
- Pg
- MJ UNJC, UNJF
- EG (STI) SELF-LOCK
- Tr, Tr-F Rd
- Zubehör Accessories
- Tech. Info

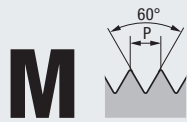

DIN 13

DIN 371

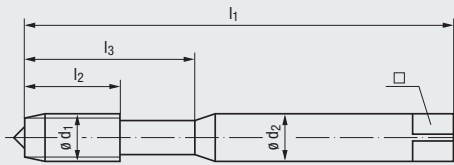

Z
CNC-controlled machines

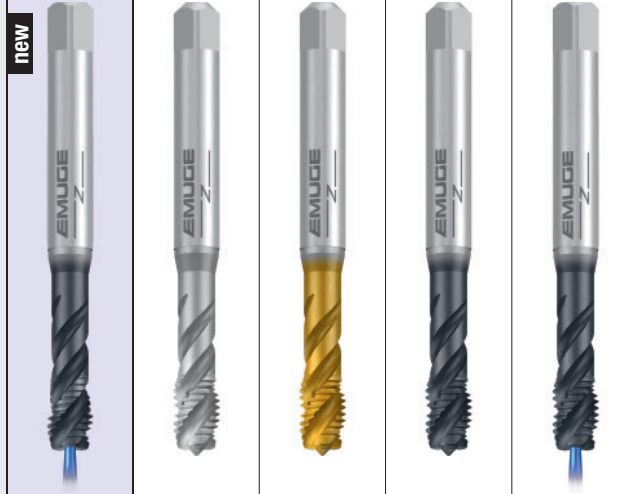

Toleranz · Tolerance
Beschichtung · Coating
Schneidstoff · Cutting material

Technische Informationen
Technical information

» 245 - 266

6GX	ISO 2/6H	ISO 2/6H	ISO 2/6H	ISO 2/6H
GLT-1		TIN	GLT-1	GLT-1
HSSE-PM	HSSE	HSSE	HSSE	HSSE
R45	R45	R45	R45	R45
E / 1,5-2	C / 2-3	C / 2-3	C / 2-3	C / 2-3
E / O	E / O / P	E / O / P	E / O / P	E / O

Gewindetiefe und Lochform
Thread depth and hole type

max. 3 x d₁



Einsatzgebiete – Material
Applications – material

» 22

P 2.1-4.1	P 1.1-4.1	P 1.1-4.1	P 1.1-4.1	P 1.1-4.1
M 1.1-3.1	M 1.1-2.1	M 1.1-3.1	M 1.1-3.1	M 1.1-3.1
K 2.1	N 2.1	N 1.4-6	N 1.4-6	N 1.4-6
N 1.4-2.2, 2.4-5		N 2.1-2, 2.4-5	N 2.1-2, 2.4-5	N 2.1-2, 2.4-5
S 1.1		S 1.1	S 1.1	S 1.1

Werkzeug-Ident · Tool ident

B583A621 B0503500 B0503700 B050C400 B099C400

M	Ø d ₁ mm	P mm	l ₁	l ₂	l ₃	Ø d ₂	□	Dimens.- Ident	Enorm	Enorm	Enorm	Enorm	Enorm	
									1-Z/E-X- IKZ PM-GLT-1 „6GX“	1-Z	1-Z TIN	1-Z GLT-1	1-Z- IKZ GLT-1	
	1	0,25	40	2,5	–	2,5	2,1	0,75	.0010					
	1,1	0,25	40	2,5	–	2,5	2,1	0,85	.0011					
	1,2	0,25	40	2,5	–	2,5	2,1	0,95	.0012					
	1,4	0,3	40	3	–	2,5	2,1	1,1	.0014					
	1,6	0,35	40	4	11	2,5	2,1	1,25	.0016					
	1,7	0,35	40	4	11	2,5	2,1	1,35	.0017					
	1,8	0,35	40	4	11	2,5	2,1	1,45	.0018					
	2	0,4	45	4	12	2,8	2,1	1,6	.0020					
	2,2	0,45	45	4,5	12	2,8	2,1	1,75	.0022					
	2,3	0,4	45	4,5	12	2,8	2,1	1,9	.0023					
	2,5	0,45	50	5	14	2,8	2,1	2,05	.0025					
	2,6	0,45	50	5	14	2,8	2,1	2,15	.0026					
	3	0,5	56	6	18	3,5	2,7	2,5	.0030		•	•	•	
	3,5	0,6	56	7	20	4	3	2,9	.0035		•	•	•	
	4	0,7	63	7	21	4,5	3,4	3,3	.0040	•	•	•	•	
	4,5	0,75	70	8	25	6	4,9	3,7	.0045		•	•	•	
	5	0,8	70	8	25	6	4,9	4,2	.0050	•	•	•	•	•
	5,5	0,9	80	10	30	6	4,9	4,6	.0055		•	•	•	
	6	1	80	10	30	6	4,9	5	.0060	•	•	•	•	•
	7	1	80	10	30	7	5,5	6	.0070		•	•	•	
	8	1,25	90	14	35	8	6,2	6,8	.0080	•	•	•	•	•
	9	1,25	90	14	35	9	7	7,8	.0090		•	•	•	
	10	1,5	100	16	39	10	8	8,5	.0100	•	•	•	•	•
	12	1,75	110	18	44	12	9	10,2	.0112					

DIN 376



81

81

81

81

81

DIN 352



Z
CNC-controlled
machines

ISO 2/6H	ISO 2/6H TIN	ISO 2/6H GLT-1	ISO 2/6H	ISO 2/6H TIN	ISO 3/6G	ISO 3/6G	6HX	6HX	6H +0,1 2)
HSSE	HSSE	HSSE	HSSE	HSSE	HSSE	HSSE	HSSE	HSSE	HSSE
R45	R45	R45	R45	R45	R45	R45	R50	R50	R50
E / 1,5-2	E / 1,5-2	E / 1,5-2	E / 1,5-2	E / 1,5-2	E / 1,5-2	E / 1,5-2	C / 2-3	C / 2-3	C / 2-3
E / O / P	E / O / P	E / O / P	E / O	E / O	E / O / P	E / O / P	E / O / P	E / O / P	E / O / P

max. 3 x d₁



P 1.1-4.1	P 1.1-4.1	P 1.1-4.1	P 1.1-4.1	P 1.1-4.1	P 1.1-4.1	P 1.1-4.1	P 1.1-4.1	P 1.1-4.1	P 1.1-4.1
M 1.1-2.1	M 1.1-3.1	M 1.1-3.1	M 1.1-2.1	M 1.1-3.1	M 1.1-2.1	M 1.1-3.1	M 1.1-2.1	M 1.1-3.1	M 1.1-2.1
N 2.1	N 1.4-6	N 1.4-6	N 2.1	N 1.4-6	N 2.1	N 1.4-6	N 2.1	N 1.4-6	N 2.1
	N 2.1-2, 2.4-5	N 2.1-2, 2.4-5		N 2.1-2, 2.4-5		N 2.1-2, 2.4-5		N 2.1-2, 2.4-5	
	S 1.1	S 1.1		S 1.1		S 1.1		S 1.1	

B0513500	B0513700	B051C400	B0973500	B0973700	B0513520	B0513720	B0653501	B0653701	B0653540
Enorm 1-Z/E	Enorm 1-Z/E TIN	Enorm 1-Z/E GLT-1	Enorm 1-Z/E- IKZ	Enorm 1-Z/E- IKZ TIN	Enorm 1-Z/E „6G“	Enorm 1-Z/E TIN „6G“	Enorm 1-Z50	Enorm 1-Z50 TIN	Enorm 1-Z50 „+0,1“

										M	1
											1,1
											1,2
											1,4
											1,6
											1,7
											1,8
○					○		○				2
											2,2
○					○		○				2,3
											2,5
●	●	●	●	●	●	●	●	●	●		2,6
○	○										3
●	●	●	●	●	●	●	●	●	●		3,5
											4
●	●	●	●	●	●	●	●	●	●		4,5
											5
											5,5
○	○	○	○	○	○	○	○	○	○		6
●	●	●	●	●	●	●	●	●	●		7
○	○	○	○	○	○	○	○	○	○		8
●	●	●	●	●	●	●	●	●	●		9
●	●	●	●	●	●	●	●	●	●		10
											12
📄 81	📄 81	📄 81		📄 81	📄 81	📄 82	📄 82	📄 82	📄 82		
📄 91											

2) Vorbohrdurchmesser für Gewindebohrer mit Übermaß um 0,1 mm anheben
Increase drill diameter for taps with oversize by 0.1 mm

Product Finder

V_c

M

MF

UNC UN-8

UNF UNEF

G, Rp NPSM, NPSF

NPT, NPTF Rc, W

BSW, BSF

Pg

MJ UNJC, UNJF

EG (STI) SELF-LOCK

Tr, Tr-F Rd

Zubehör Accessories

Tech. Info



- Product Finder
- V_c
- M
- MF
- UNC UN-8
- UNF UNEF
- G, Rp NPSM, NPSF
- NPT, NPTF Rc, W
- BSW, BSF
- Pg
- MJ UNJC, UNJF
- EG (STI) SELF-LOCK
- Tr, Tr-F Rd
- Zubehör Accessories
- Tech. Info

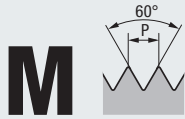

DIN 13

DIN 371

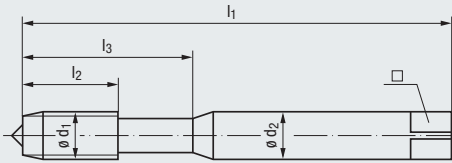

SPEED
High-speed cutting



Toleranz · Tolerance
Beschichtung · Coating
Schneidstoff · Cutting material

Technische Informationen
Technical information

» 245 - 266



6HX	6HX	6HX	6HX
TICN	TICN	TICN	TICN
HSSE	HSSE	HSSE	HSSE
C / 2-3	C / 2-3	E / 1,5-2	E / 1,5-2
E	E	E	E

Gewindetiefe und Lochform
Thread depth and hole type

max. 2 x d ₁	max. 2 x d ₁	max. 2 x d ₁	max. 2 x d ₁

Einsatzgebiete – Material
Applications – material

» 22

K 1.1-4.2	K 1.1-4.2	K 1.1-4.2	K 1.1-4.2
N 1.4-6	N 1.4-6	N 1.4-6	N 1.4-6

Werkzeug-Ident · Tool ident

B3159401 B3179401 B3169401 B3189401

M	ø d ₁ mm	P mm	l ₁	l ₂	l ₃	ø d ₂	□		Dimens.- Ident	Rekord 1A-SPEED IKZ-TICN	Rekord 1A-SPEED IKZN-TICN	Rekord 1A-SPEED/E IKZ-TICN	Rekord 1A-SPEED/E IKZN-TICN
1	1	0,25	40	2,5	–	2,5	2,1	0,75	.0010				
1,1	1,1	0,25	40	2,5	–	2,5	2,1	0,85	.0011				
1,2	1,2	0,25	40	2,5	–	2,5	2,1	0,95	.0012				
1,4	1,4	0,3	40	3	–	2,5	2,1	1,1	.0014				
1,6	1,6	0,35	40	4	11	2,5	2,1	1,25	.0016				
1,7	1,7	0,35	40	4	11	2,5	2,1	1,35	.0017				
1,8	1,8	0,35	40	4	11	2,5	2,1	1,45	.0018				
2	2	0,4	45	4	12	2,8	2,1	1,6	.0020				
2,2	2,2	0,45	45	4,5	12	2,8	2,1	1,75	.0022				
2,3	2,3	0,4	45	4,5	12	2,8	2,1	1,9	.0023				
2,5	2,5	0,45	50	5	14	2,8	2,1	2,05	.0025				
2,6	2,6	0,45	50	5	14	2,8	2,1	2,15	.0026				
3	3	0,5	56	6	18	3,5	2,7	2,5	.0030				
3,5	3,5	0,6	56	7	20	4	3	2,9	.0035				
4	4	0,7	63	7	21	4,5	3,4	3,3	.0040	●		●	
4,5	4,5	0,75	70	8	25	6	4,9	3,7	.0045				
5	5	0,8	70	8	25	6	4,9	4,2	.0050	●	○	●	○
5,5	5,5	0,9	80	10	30	6	4,9	4,6	.0055				
6	6	1	80	10	30	6	4,9	5	.0060	●	○	●	○
7	7	1	80	10	30	7	5,5	6	.0070				
8	8	1,25	90	14	35	8	6,2	6,8	.0080	●	○	●	○
9	9	1,25	90	14	35	9	7	7,8	.0090				
10	10	1,5	100	16	39	10	8	8,5	.0100	●	○	●	○
12	12	1,75	110	18	44	12	9	10,2	.0112				

DIN 376

» 83 » 83 » 83 » 83

DIN 352

1) Gewindebohren in Durchgangslöcher nur mit externer Kühlschmierung möglich
Threading in through holes is possible only with external cooling/lubrication

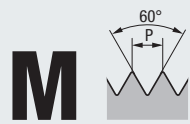

DIN 13

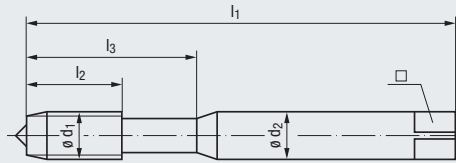

DIN 371

SPEED
High-speed cutting

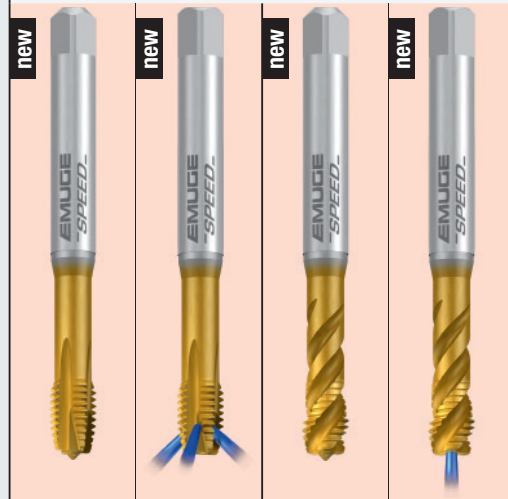

Toleranz · Tolerance
Beschichtung · Coating
Schneidstoff · Cutting material

Technische Informationen
Technical information

» 245 - 266

6HX	6HX	6HX	6HX
TIN-70	TIN-70	TIN-60	TIN-60
HSSE-PM	HSSE-PM	HSSE-PM	HSSE-PM
B / 4-5	B / 4-5	C / 2-3	C / 2-3
E	E	E	E

Gewindetiefe und Lochform
Thread depth and hole type

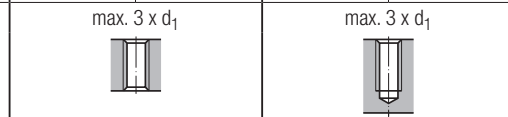

Einsatzgebiete – Material
Applications – material

» 22

P 1.1-4.1	P 1.1-4.1	P 2.1-4.1	P 2.1-4.1
K 2.1-2	K 2.1-2		
N 1.4-6	N 1.4-6		

Werkzeug-Ident · Tool ident

M	ø d ₁ mm	P mm	l ₁	l ₂	l ₃	ø d ₂	□	Dimens.- Ident	Rekord	Rekord	Enorm	Enorm	
									1B-Z-SPEED PM-TIN-70	1B-Z-SPEED IKZN-PM TIN-70	1-Z-SPEED X-PM TIN-60	1-Z-SPEED X-IKZ-PM TIN-60	
	1	0,25	40	2,5	–	2,5	2,1	0,75	.0010				
	1,1	0,25	40	2,5	–	2,5	2,1	0,85	.0011				
	1,2	0,25	40	2,5	–	2,5	2,1	0,95	.0012				
	1,4	0,3	40	3	–	2,5	2,1	1,1	.0014				
	1,6	0,35	40	4	11	2,5	2,1	1,25	.0016				
	1,7	0,35	40	4	11	2,5	2,1	1,35	.0017				
	1,8	0,35	40	4	11	2,5	2,1	1,45	.0018				
	2	0,4	45	4	12	2,8	2,1	1,6	.0020				
	2,2	0,45	45	4,5	12	2,8	2,1	1,75	.0022				
	2,3	0,4	45	4,5	12	2,8	2,1	1,9	.0023				
	2,5	0,45	50	5	14	2,8	2,1	2,05	.0025				
	2,6	0,45	50	5	14	2,8	2,1	2,15	.0026				
	3	0,5	56	6	18	3,5	2,7	2,5	.0030				
	3,5	0,6	56	7	20	4	3	2,9	.0035				
	4	0,7	63	7	21	4,5	3,4	3,3	.0040	●		●	
	4,5	0,75	70	8	25	6	4,9	3,7	.0045	●	○	●	●
	5	0,8	70	8	25	6	4,9	4,2	.0050	●	○	●	●
	5,5	0,9	80	10	30	6	4,9	4,6	.0055	●	○	●	●
	6	1	80	10	30	6	4,9	5	.0060	●	○	●	●
	7	1	80	10	30	7	5,5	6	.0070	●	○	●	●
	8	1,25	90	14	35	8	6,2	6,8	.0080	●	○	●	●
	9	1,25	90	14	35	9	7	7,8	.0090	●	○	●	●
	10	1,5	100	16	39	10	8	8,5	.0100	●	○	●	●
	12	1,75	110	18	44	12	9	10,2	.0112	●	○	●	●

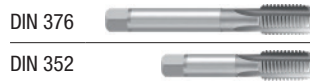

83	83	83	83
----	----	----	----

- Product Finder
- Vc
- M
- MF
- UNC UN-8
- UNF UNEF
- G, Rp NPSM, NPSF
- NPT, NPTF Rc, W
- BSW, BSF
- Pg
- MJ UNJC, UNJF
- EG (ST) SELF-LOCK
- Tr, Tr-F Rd
- Zubehör Accessories
- Tech. Info



● = Lagerwerkzeug, siehe Preisliste · Stock tool, see price list
○ = Kurzfristig lieferbar, Preis auf Anfrage · Available on short notice, price upon inquiry

- Product Finder
- Vc
- M**
- MF
- UNC UN-8
- UNF UNEF
- G, Rp NPSM, NPSF
- NPT, NPTF Rc, W
- BSW, BSF
- Pg
- MJ UNJC, UNJF
- EG (STI) SELF-LOCK
- Tr, Tr-F Rd
- Zubehör Accessories
- Tech. Info

M



DIN 13

Mit extra langem Schaft
With extra long shank

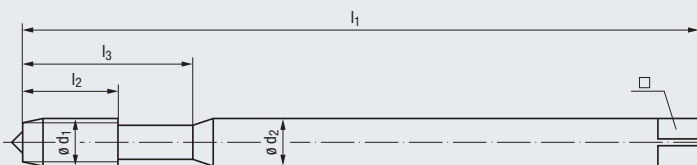

















STEEL
Steel materials



<p>Toleranz · Tolerance Beschichtung · Coating Schneidstoff · Cutting material</p> <p>Technische Informationen Technical information</p> <p>Technical information » 245 - 266</p>		<p>ISO 2/6H</p> <p>HSSE</p> <p>B / 4-5</p> <p>E / 0</p>	<p>new</p> <p>ISO 2/6H</p> <p>HSSE</p> <p>E / 1,5-2</p> <p>E / 0</p>	<p>ISO 2/6H</p> <p>TIN</p> <p>HSSE</p> <p>R15</p> <p>C / 2-3</p> <p>E / 0</p>	<p>ISO 2/6H</p> <p>HSSE</p> <p>R35</p> <p>C / 2-3</p> <p>E / 0</p>								
<p>Gewindetiefe und Lochform Thread depth and hole type</p>		<p>max. 3 x d₁</p>	<p>max. 2 x d₁</p>	<p>max. 2,5 x d₁</p>									
<p>Einsatzgebiete – Material Applications – material</p> <p>Applications – material » 22</p>		<p>P 2.1-4.1</p>	<p>P 2.1-3.1</p>	<p>P 1.1-4.1</p> <p>K 1.1-4.2</p> <p>N 1.4-5, 2.4-5</p>	<p>P 1.1-3.1</p> <p>N 2.2</p>								
<p>Werkzeug-Ident · Tool ident</p>		<p>B2201000</p> <p>Rekord 1B-STEEL-M LS</p>	<p>B2461000</p> <p>Rekord 1D-STEEL/E LS</p>	<p>B2401400</p> <p>Rekord 1DF-STEEL LS-TIN</p>	<p>B2501000</p> <p>Enorm 1-STEEL-LS</p>								
<p>Ø d₁ mm</p>	<p>P mm</p>	<p>l₁</p>	<p>l₂</p>	<p>l₃</p>	<p>Ø d₂</p>	<p>□</p>		<p>Dimens.-Ident</p>	<p>86</p>	<p>86</p>	<p>86</p>	<p>86</p>	
M	3	0,5	100	11	18	3,5	2,7	2,5	.0030	•	•	•	•
	4	0,7	125	13	21	4,5	3,4	3,3	.0040	•	•	•	•
	5	0,8	140	15	25	6	4,9	4,2	.0050	•	•	•	•
	6	1	160	17	30	6	4,9	5	.0060	•	•	•	•
	8	1,25	180	20	35	8	6,2	6,8	.0080	•	•	•	•
	10	1,5	200	22	39	10	8	8,5	.0100	•	•	•	•

1) Ab M4 auch mit innerer Kühlschmierstoff-Zufuhr IKZ möglich
From M4 also available with internal coolant supply IKZ

2) Ab M5 auch mit innerer Kühlschmierstoff-Zufuhr IKZN möglich
From M5 also available with internal coolant supply IKZN

VA Stainless steel materials				H Materials of high tensile strength	Z CNC-controlled machines			
	new 		new 		new 			
ISO 2/6H	ISO 2/6H	ISO 2/6H	ISO 2/6H	6HX	6HX			
NT	GLT-1		GLT-1	NT	TIN			
HSSE	HSSE	HSSE	HSSE	HSSE	HSSE			
		R35	R35		R15			
B / 4-5	B / 4-5	C / 2-3	C / 2-3	C / 2-3	C / 2-3			
E / O / P	E / O / P	E / O / P	E / O / P	E / O / P	E / O			
max. 3 x d ₁		max. 2,5 x d ₁		max. 2 x d ₁	max. 2 x d ₁			
								
P 1.1-3.1	P 1.1-4.1	P 1.1-3.1	P 1.1-4.1	P 1.1-3.1	P 2.1-5.1			
M 1.1-2.1	M 1.1-3.1	M 1.1-2.1	M 1.1-3.1	K 1.1-4.2	K 2.1-2			
K 2.1	K 2.1	K 2.1	K 2.1	N 2.4-7	N 1.4-6, 2.4-5			
N 2.2, 2.5-6	N 2.2			N 4.1, 5.1				
B2203000	B220C300	B2503000	B250C300	B2100501	B4093701			
Rekord 1B-VA-LS NT	Rekord 1B-VA-LS GLT-1	Enorm 1-VA-LS	Enorm 1-VA-LS GLT-1	Rekord 1A-H-LS NT	Rekord 1D-Z-BF IKZ-LS TIN			
●	●	●	●	●	○			M 3
●	●	●	●	●	○			4
●	●	●	●	●	○			5
●	●	●	●	●	○			6
●	●	●	●	●	○			8
					○			10
 87	 87	 87	 87	 87	 87			

- Product Finder
- V_c
- M
- MF
- UNC UN-8
- UNF UNEF
- G, Rp NPSM, NPSF
- NPT, NPTF Rc, W
- BSW, BSF
- Pg
- MJ UNJC, UNJF
- EG (STI) SELF-LOCK
- Tr, Tr-F Rd
- Zubehör Accessories
- Tech. Info

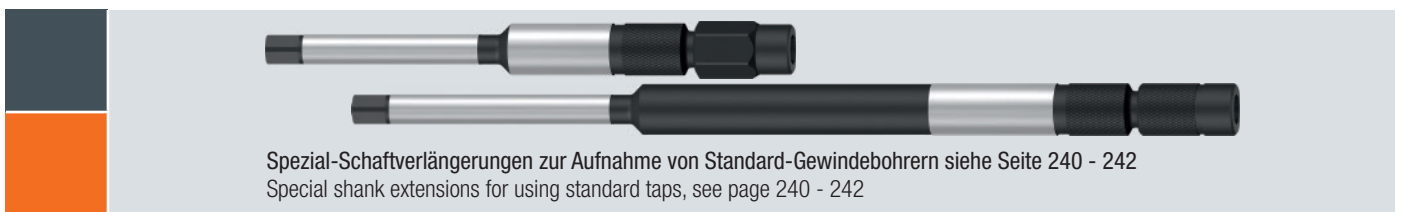

Spezial-Schaftverlängerungen zur Aufnahme von Standard-Gewindebohrern siehe Seite 240 - 242
 Special shank extensions for using standard taps, see page 240 - 242

● = Lagerwerkzeug, siehe Preisliste · Stock tool, see price list
 ○ = Kurzfristig lieferbar, Preis auf Anfrage · Available on short notice, price upon inquiry

- Product Finder
- Vc
- M
- MF
- UNC UN-8
- UNF UNEF
- G, Rp NPSM, NPSF
- NPT, NPTF Rc, W
- BSW, BSF
- Pg
- MJ UNJC, UNJF
- EG (STI) SELF-LOCK
- Tr, Tr-F Rd
- Zubehör Accessories
- Tech. Info



DIN 13

DIN 376

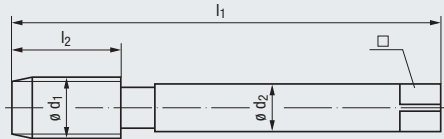

STEEL
Steel materials

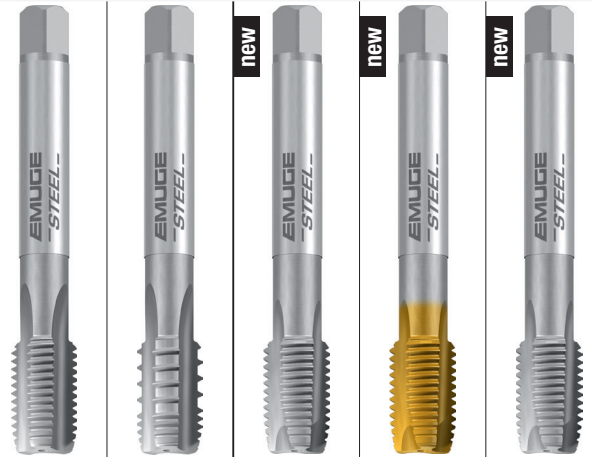

Toleranz · Tolerance
Beschichtung · Coating
Schneidstoff · Cutting material

Technische Informationen
Technical information

» 245 - 266



6HX	6HX	ISO 2/6H	ISO 2/6H	ISO 1/4H
HSSE	HSSE	HSSE	TIN HSSE	HSSE
C / 2-3	C / 2-3	B / 4-5	B / 4-5	B / 4-5
E / O	E / O	E / O	E / O	E / O

Gewindetiefe und Lochform
Thread depth and hole type



Einsatzgebiete – Material
Applications – material

» 22

P 1.1-3.1 N 2.3	P 1.1-3.1 N 2.3	P 1.1-3.1 N 2.2	P 1.1-4.1 K 2.1 N 2.2, 2.4-5	P 1.1-3.1 N 2.2
--------------------	--------------------	--------------------	------------------------------------	--------------------

Werkzeug-Ident · Tool ident

M	Ø d ₁ mm	P mm	l ₁	l ₂	Ø d ₂	□	Dimens.- Ident	Rekord	Rekord	Rekord	Rekord	Rekord
								2A-STEEL	2A-STEEL-AZ	2B-STEEL-L	2B-STEEL-L TIN	2B-STEEL-L „4H“
	3	0,5	56	11	2,2	–	.0030					
	4	0,7	63	13	2,8	2,1	.0040					
	5	0,8	70	15	3,5	2,7	.0050					
	6	1	80	17	4,5	3,4	.0060					
	7	1	80	17	5,5	4,3	.0070					
	8	1,25	90	20	6	4,9	.0080					
	9	1,25	90	20	7	5,5	.0090					
	10	1,5	100	22	7	5,5	.0100					
	11	1,5	100	22	8	6,2	.0111					
	12	1,75	110	24	9	7	.0112					
	14	2	110	26	11	9	.0114					
	16	2	110	27	12	9	.0116					
	18	2,5	125	30	14	11	.0118					
	20	2,5	140	32	16	12	.0120					
	22	2,5	140	32	18	14,5	.0122					
	24	3	160	34	18	14,5	.0124					
	27	3	160	36	20	16	.0127					
	30	3,5	180	40	22	18	.0130					
	33	3,5	180	40	25	20	.0133					
	36	4	200	50	28	22	.0136					
	39	4	200	50	32	24	.0139					
	42	4,5	200	56	32	24	.0142					
	45	4,5	220	58	36	29	.0145					
	48	5	250	65	36	29	.0148					
	52	5	250	65	40	32	.0152					

DIN 371		36	36	36	36	37
DIN 352		90	90			

STEEL
Steel materials

new	new	new	new	new	new	new			new
ISO 1/4H	ISO 3/6G	ISO 3/6G	7G	7G	ISO 2/6H	ISO 2/6H	ISO 2/6H	ISO 2/6H	6HX
TIN		TIN		TIN		TIN		TIN	CRT
HSSE	HSSE	HSSE	HSSE	HSSE	HSSE	HSSE	HSSE	HSSE	HSSE-PM
					LH	LH			
B / 4-5	B / 4-5	B / 4-5	B / 4-5	B / 4-5	B / 4-5	B / 4-5	B / 4-5	B / 4-5	B / ≈6
E / 0	E / 0	E / 0	E / 0	E / 0	E / 0	E / 0	E / 0	E / 0	E / 0

max. 3 x d₁



P 1.1-4.1	P 1.1-3.1	P 1.1-4.1	P 1.1-3.1	P 1.1-4.1	P 1.1-3.1	P 1.1-4.1	P 2.1-4.1	P 2.1-4.1	P 3.1-5.1
K 2.1	N 2.2	K 2.1	N 2.2	K 2.1	N 2.2	K 2.1		K 2.1	
N 2.2, 2.4-5		N 2.2, 2.4-5		N 2.2, 2.4-5		N 2.2, 2.4-5			
C0208410	C0208920	C0208420	C0208930	C0208430	C0208950	C0208450	C0201000	C0201400	C0208E01
Rekord 2B-STEEL-L TIN „4H“	Rekord 2B-STEEL-L „6G“	Rekord 2B-STEEL-L TIN „6G“	Rekord 2B-STEEL-L „7G“	Rekord 2B-STEEL-L TIN „7G“	Rekord 2B-STEEL-L LH	Rekord 2B-STEEL-L LH-TIN	Rekord 2B-STEEL-M	Rekord 2B-STEEL-M TIN	Rekord 2B-STEEL-H PM-CRT

										M	3
											4
											5
											6
											7
											8
											9
											10
●	●	●	●	●	●	●	●	●	●		11
○	○	○	○	○	○	○	○	○	○		12
●	●	●	●	●	●	●	●	●	●		14
○	○	○	○	○	○	○	○	○	○		16
●	●	●	●	●	●	●	●	●	●		18
○	○	○	○	○	○	○	○	○	○		20
●	●	●	●	●	●	●	●	●	●		22
○	○	○	○	○	○	○	○	○	○		24
●	●	●	●	●	●	●	●	●	●		27
											30
											33
											36
											39
											42
											45
											48
											52
📄 37	📄 37	📄 37	📄 37	📄 37	📄 37	📄 37	📄 37	📄 37	📄 39		
							📄 90				

Product Finder

Vc

M

MF

UNC UN-8

UNC UNEF

G, Rp NPSM, NPSF

NPT, NPTF Rc, W

BSW, BSF

Pg

MJ UNJC, UNJF

EG (STI) SELF-LOCK

Tr, Tr-F Rd

Zubehör Accessories

Tech. Info

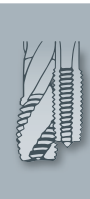

● = Lagerwerkzeug, siehe Preisliste · Stock tool, see price list
○ = Kurzfristig lieferbar, Preis auf Anfrage · Available on short notice, price upon inquiry

- Product Finder
- Vc
- M
- MF
- UNC UN-8
- UNF UNEF
- G, Rp NPSM, NPSF
- NPT, NPTF Rc, W
- BSW, BSF
- Pg
- MJ UNJC, UNJF
- EG (STI) SELF-LOCK
- Tr, Tr-F Rd
- Zubehör Accessories
- Tech. Info

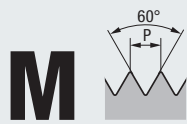

DIN 13

DIN 376

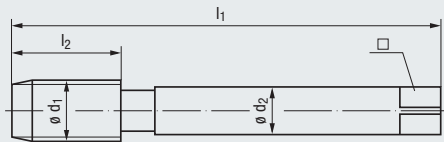

STEEL
Steel materials



Toleranz · Tolerance
Beschichtung · Coating
Schneidstoff · Cutting material

Technische Informationen
Technical information

Technical information icon: 245 - 266

ISO 2/6H	ISO 2/6H	ISO 2/6H	ISO 2/6H	ISO 2/6H
HSSE	HSSE	TIN	HSSE	TIN
R15	R15	HSSE	R35	R35
C / 2-3	E / 1,5-2	C / 2-3	C / 2-3	C / 2-3
E / 0	E / 0	E / 0	E / 0	E / 0

Gewindetiefe und Lochform
Thread depth and hole type



Einsatzgebiete – Material
Applications – material

Technical information icon: 22

P 2.1-3.1	P 2.1-3.1	P 1.1-4.1 K 1.1-4.2 N 1.4-5, 2.4-5	P 1.1-3.1 N 2.2	P 1.1-4.1 K 2.1 N 2.2
-----------	-----------	--	--------------------	-----------------------------

Werkzeug-Ident · Tool ident

C0451000 C0461000 C0401400 C0501000 C0501400

M	Ø d ₁ mm	P mm	l ₁	l ₂	Ø d ₂	□	Tap Image	Dimens.- Ident	Rekord	Rekord	Rekord	Enorm	Enorm
									2D-STEEL	2D-STEEL/E	2DF-STEEL TIN	2-STEEL	2-STEEL TIN
3	0,5	56	11	2,2	–	–	2,5	.0030				●	
4	0,7	63	13	2,8	2,1	3,3	3,3	.0040				●	
5	0,8	70	15	3,5	2,7	4,2	4,2	.0050				●	
6	1	80	17	4,5	3,4	5	5	.0060	●			●	
7	1	80	17	5,5	4,3	6	6	.0070				●	
8	1,25	90	20	6	4,9	6,8	6,8	.0080	●			●	
9	1,25	90	20	7	5,5	7,8	7,8	.0090				●	
10	1,5	100	22	7	5,5	8,5	8,5	.0100	●			●	
11	1,5	100	22	8	6,2	9,5	9,5	.0111				●	
12	1,75	110	24	9	7	10,2	10,2	.0112	●	●	●	●	●
14	2	110	26	11	9	12	12	.0114			●	●	●
16	2	110	27	12	9	14	14	.0116	●	●	●	●	●
18	2,5	125	30	14	11	15,5	15,5	.0118			●	●	●
20	2,5	140	32	16	12	17,5	17,5	.0120	●	●	●	●	●
22	2,5	140	32	18	14,5	19,5	19,5	.0122			●	●	●
24	3	160	34	18	14,5	21	21	.0124	●	●	○	●	●
27	3	160	36	20	16	24	24	.0127	●			●	●
30	3,5	180	40	22	18	26,5	26,5	.0130	●			●	●
33	3,5	180	40	25	20	29,5	29,5	.0133				●	●
36	4	200	50	28	22	32	32	.0136				●	○
39	4	200	50	32	24	35	35	.0139				●	●
42	4,5	200	56	32	24	37,5	37,5	.0142				●	●
45	4,5	220	58	36	29	40,5	40,5	.0145				●	●
48	5	250	65	36	29	43	43	.0148				●	●
52	5	250	65	40	32	47	47	.0152				●	●

DIN 371
DIN 352

39	39	39	39	39
91			91	

STEEL
Steel
materials

ISO 1/4H	ISO 1/4H	ISO 3/6G	ISO 3/6G	7G	7G	ISO 2/6H	ISO 2/6H	ISO 2/6H	ISO 2/6H	ISO 2/6H
	TIN		TIN		TIN		TIN		TIN	TIN
HSSE	HSSE	HSSE	HSSE	HSSE	HSSE	HSSE	HSSE	HSSE	HSSE	HSSE
R35	R35	R35	R35	R35	R35	LH, L35	LH, L35	R35	R35	R35
C / 2-3	C / 2-3	C / 2-3	C / 2-3	C / 2-3	C / 2-3	C / 2-3	C / 2-3	C / 2-3	C / 2-3	C / 2-3
E / 0	E / 0	E / 0	E / 0	E / 0	E / 0	E / 0	E / 0	E / 0	E / 0	E / 0

max. 2,5 x d₁



P 1.1-3.1	P 1.1-4.1	P 1.1-3.1	P 1.1-4.1	P 1.1-3.1	P 1.1-4.1	P 1.1-3.1	P 1.1-4.1	P 1.1-3.1	P 1.1-4.1
N 2.2	K 2.1	N 2.2	K 2.1	N 2.2	K 2.1	N 2.2	K 2.1	N 2.2	K 2.1
	N 2.2		N 2.2		N 2.2		N 2.2		N 2.2

C0501010	C0501410	C0501020	C0501420	C0501030	C0501430	C0501050	C0501450	C0601000	C0601400
Enorm 2-STEEL „4H“	Enorm 2-STEEL TIN „4H“	Enorm 2-STEEL „6G“	Enorm 2-STEEL TIN „6G“	Enorm 2-STEEL „7G“	Enorm 2-STEEL TIN „7G“	Enorm 2-STEEL-LH	Enorm 2-STEEL-LH TIN	Enorm 2-STEEL-X	Enorm 2-STEEL-X TIN

										M	3
											4
											5
											6
											7
											8
											9
											10
											11
●	○	●	●	●	●	●	●	●	●		12
●	○	●	●	●	●	●	●	●	●		14
●	○	●	●	●	●	●	●	●	●		16
●	○	●	●	●	●	●	○	●	●		18
○	○	●	●	●	●	●	○	○	○		20
											22
											24
											27
								○	○		30
								○	○		33
											36
											39
											42
											45
											48
											52
39	39	39	39	40	40	40	40	40	41		

Product Finder

V_c

M

MF

UNC UN-8

UNF

G, Rp NPSM, NPSF

NPT, NPTF Rc, W

BSW, BSF

Pg

MJ UNJC, UNJF

EG (STI) SELF-LOCK

Tr, Tr-F Rd

Zubehör Accessories

Tech. Info



- Product Finder
- Vc
- M
- MF
- UNC UN-8
- UNF UNEF
- G, Rp NPSM, NPSF
- NPT, NPTF Rc, W
- BSW, BSF
- Pg
- MJ UNJC, UNJF
- EG (STI) SELF-LOCK
- Tr, Tr-F Rd
- Zubehör Accessories
- Tech. Info



DIN 13

DIN 376

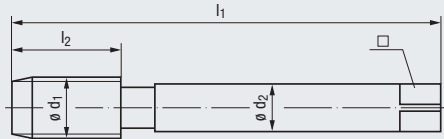

VA
Stainless steel materials



Toleranz · Tolerance
Beschichtung · Coating
Schneidstoff · Cutting material

Technische Informationen
Technical information

» 245 - 266

Schneidstoff · Cutting material



ISO 2/6H	ISO 2/6H	ISO 2/6H	ISO 1/4H	ISO 1/4H
NT	TIN	GLT-1	NT	TIN
HSSE	HSSE	HSSE	HSSE	HSSE
B / 4-5	B / 4-5	B / 4-5	B / 4-5	B / 4-5
E / O / P	E / O / P	E / O / P	E / O / P	E / O / P

Gewindetiefe und Lochform
Thread depth and hole type

max. 3 x d₁



Einsatzgebiete – Material
Applications – material

» 22

P 1.1-3.1	P 1.1-4.1	P 1.1-4.1	P 1.1-3.1	P 1.1-4.1
M 1.1-2.1	M 1.1-3.1	M 1.1-3.1	M 1.1-2.1	M 1.1-3.1
K 2.1	K 2.1	K 2.1	K 2.1	K 2.1
N 2.2, 2.5-6	N 2.2, 2.5-6	N 2.2	N 2.2, 2.5-6	N 2.2, 2.5-6

Werkzeug-Ident · Tool ident

M	Ø d ₁ mm	P mm	l ₁	l ₂	Ø d ₂	□	Dimens.- Ident	Rekord 2B-VA NT	Rekord 2B-VA TIN	Rekord 2B-VA GLT-1	Rekord 2B-VA NT „4H“	Rekord 2B-VA TIN „4H“
								C0203000	C0203100	C020C300	C0203010	C0203110
	3	0,5	56	11	2,2	–	.0030					
	4	0,7	63	13	2,8	2,1	.0040					
	5	0,8	70	15	3,5	2,7	.0050	●	●	●		
	6	1	80	17	4,5	3,4	.0060	●	●	●		
	7	1	80	17	5,5	4,3	.0070					
	8	1,25	90	20	6	4,9	.0080	●	●	●		
	9	1,25	90	20	7	5,5	.0090					
	10	1,5	100	22	7	5,5	.0100	●	●	●		
	11	1,5	100	22	8	6,2	.0111	●	●	●		
	12	1,75	110	24	9	7	.0112	●	●	●	●	○
	14	2	110	26	11	9	.0114	●	●	●	○	○
	16	2	110	27	12	9	.0116	●	●	●	●	○
	18	2,5	125	30	14	11	.0118	●	●	●	○	○
	20	2,5	140	32	16	12	.0120	●	●	●	●	○
	22	2,5	140	32	18	14,5	.0122	●	●	●	○	○
	24	3	160	34	18	14,5	.0124	●	●	●	●	○
	27	3	160	36	20	16	.0127	●	●	●		
	30	3,5	180	40	22	18	.0130	●	●	●		
	33	3,5	180	40	25	20	.0133	●	○	○		
	36	4	200	50	28	22	.0136	●	○	○		
	39	4	200	50	32	24	.0139	●	○	○		
	42	4,5	200	56	32	24	.0142	●	○	○		
	45	4,5	220	58	36	29	.0145	●	○	○		
	48	5	250	65	36	29	.0148	●	○	○		
	52	5	250	65	40	32	.0152	●	○	○		

DIN 371

41 41 41 41 41

DIN 352

91

VA
Stainless steel
materials

new		new	new		new	new	new	new	new	new
ISO 1/4H	ISO 3/6G	ISO 3/6G	ISO 3/6G	7G	7G	7G	ISO 2/6H	ISO 2/6H	ISO 2/6H	ISO 2/6H
GLT-1	NT	TIN	GLT-1	NT	TIN	GLT-1	NT	TIN	GLT-1	GLT-1
HSSE	HSSE	HSSE	HSSE	HSSE	HSSE	HSSE	HSSE	HSSE	HSSE	HSSE
							LH	LH	LH	LH
B / 4-5	B / 4-5	B / 4-5	B / 4-5	B / 4-5	B / 4-5	B / 4-5	B / 4-5	B / 4-5	B / 4-5	B / 4-5
E / O / P	E / O / P	E / O / P	E / O / P	E / O / P	E / O / P	E / O / P	E / O / P	E / O / P	E / O / P	E / O / P

max. 3 x d₁



P 1.1-4.1	P 1.1-3.1	P 1.1-4.1	P 1.1-4.1	P 1.1-3.1	P 1.1-4.1	P 1.1-4.1	P 1.1-3.1	P 1.1-4.1	P 1.1-4.1
M 1.1-3.1	M 1.1-2.1	M 1.1-3.1	M 1.1-3.1	M 1.1-2.1	M 1.1-3.1	M 1.1-3.1	M 1.1-2.1	M 1.1-3.1	M 1.1-3.1
K 2.1	K 2.1	K 2.1	K 2.1	K 2.1	K 2.1	K 2.1	K 2.1	K 2.1	K 2.1
N 2.2	N 2.2, 2.5-6	N 2.2, 2.5-6	N 2.2	N 2.2, 2.5-6	N 2.2, 2.5-6	N 2.2	N 2.2, 2.5-6	N 2.2, 2.5-6	N 2.2
C020C310	C0203020	C0203120	C020C320	C0203030	C0203130	C020C330	C0203050	C0203150	C020C350
Rekord 2B-VA GLT-1 „4H“	Rekord 2B-VA NT „6G“	Rekord 2B-VA TIN „6G“	Rekord 2B-VA GLT-1 „6G“	Rekord 2B-VA NT „7G“	Rekord 2B-VA TIN „7G“	Rekord 2B-VA GLT-1 „7G“	Rekord 2B-VA-LH NT	Rekord 2B-VA-LH TIN	Rekord 2B-VA-LH GLT-1

										M	3
											4
											5
											6
											7
											8
											9
											10
											11
○	●	○	○	●	○	○	●	○	○		12
○	○	○	○	○	○	○	○	○	○		14
○	●	○	○	●	○	○	●	○	○		16
○	○	○	○	○	○	○	○	○	○		18
○	●	○	○	●	○	○	●	○	○		20
○	○	○	○	○	○	○	○	○	○		22
○	●	○	○	●	○	○	●	○	○		24
											27
											30
											33
											36
											39
											42
											45
											48
											52
41	41	41	42	42	42	42	42	43	43		

● = Lagerwerkzeug, siehe Preisliste · Stock tool, see price list
○ = Kurzfristig lieferbar, Preis auf Anfrage · Available on short notice, price upon inquiry

Product Finder

V_c

M

MF

UNC UN-8

UNF UNEF

G, Rp NPSM, NPSF

NPT, NPTF Rc, W

BSW, BSF

Pg

MJ UNJC, UNJF

EG (ST) SELF-LOCK

Tr, Tr-F Rd

Zubehör Accessories

Tech. Info



- Product Finder
- Vc
- M
- MF
- UNC UN-8
- UNF UNEF
- G, Rp NPSM, NPSF
- NPT, NPTF Rc, W
- BSW, BSF
- Pg
- MJ UNJC, UNJF
- EG (STI) SELF-LOCK
- Tr, Tr-F Rd
- Zubehör Accessories
- Tech. Info

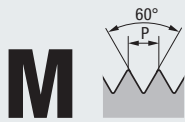

DIN 13

DIN 376

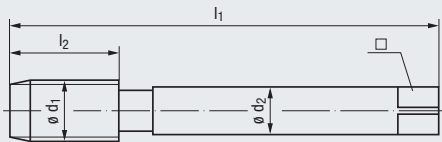

VA
Stainless steel materials

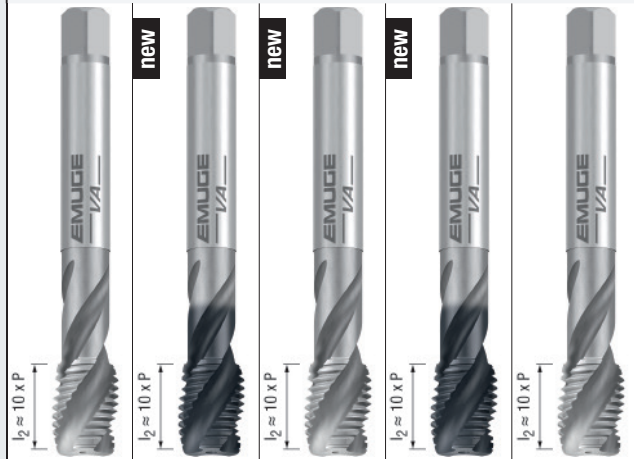

Toleranz · Tolerance
Beschichtung · Coating
Schneidstoff · Cutting material

Technische Informationen
Technical information

» 245 - 266



ISO 2/6H	ISO 2/6H	ISO 1/4H	ISO 1/4H	ISO 3/6G
HSSE	GLT-1	HSSE	GLT-1	HSSE
R35	R35	R35	R35	R35
C / 2-3	C / 2-3	C / 2-3	C / 2-3	C / 2-3
E / O / P	E / O / P	E / O / P	E / O / P	E / O / P

Gewindetiefe und Lochform
Thread depth and hole type

max. 2,5 x d₁



Einsatzgebiete – Material
Applications – material

» 22

P 1.1-3.1	P 1.1-4.1	P 1.1-3.1	P 1.1-4.1	P 1.1-3.1
M 1.1-2.1	M 1.1-3.1	M 1.1-2.1	M 1.1-3.1	M 1.1-2.1
K 2.1	K 2.1	K 2.1	K 2.1	K 2.1

Werkzeug-Ident · Tool ident

M	Ø d ₁ mm	P mm	l ₁	l ₂	Ø d ₂	□	Dimens.- Ident	Werkzeug-Ident · Tool ident				
								Enorm 2-VA	Enorm 2-VA GLT-1	Enorm 2-VA „4H“	Enorm 2-VA GLT-1 „4H“	Enorm 2-VA „6G“
	3	0,5	56	11	2,2	–	.0030	○				
	4	0,7	63	13	2,8	2,1	.0040	○				
	5	0,8	70	15	3,5	2,7	.0050	○				
	6	1	80	17	4,5	3,4	.0060	○				
	7	1	80	17	5,5	4,3	.0070	○				
	8	1,25	90	20	6	4,9	.0080	○				
	9	1,25	90	20	7	5,5	.0090	○				
	10	1,5	100	22	7	5,5	.0100	○				
	11	1,5	100	22	8	6,2	.0111	○				
	12	1,75	110	24	9	7	.0112	●	○	●	○	●
	14	2	110	26	11	9	.0114	●	○	○	○	○
	16	2	110	27	12	9	.0116	●	○	●	○	●
	18	2,5	125	30	14	11	.0118	●	○	○	○	○
	20	2,5	140	32	16	12	.0120	●	○	●	○	●
	22	2,5	140	32	18	14,5	.0122	●	○	○	○	○
	24	3	160	34	18	14,5	.0124	●	○	●	○	●
	27	3	160	36	20	16	.0127	●	○			
	30	3,5	180	40	22	18	.0130	●	○			
	33	3,5	180	40	25	20	.0133	○				
	36	4	200	50	28	22	.0136	○				
	39	4	200	50	32	24	.0139	○				
	42	4,5	200	56	32	24	.0142	○				
	45	4,5	220	58	36	29	.0145	○				
	48	5	250	65	36	29	.0148	○				
	52	5	250	65	40	32	.0152					

DIN 371

» 43

» 43

» 43

» 43

» 43

DIN 352

- Product Finder
- Vc
- M
- MF
- UNC UN-8
- UNF UNEF
- G, Rp NPSM, NPSF
- NPT, NPTF Rc, W
- BSW, BSF
- Pg
- MJ UNJC, UNJF
- EG (STI) SELF-LOCK
- Tr, Tr-F Rd
- Zubehör Accessories
- Tech. Info

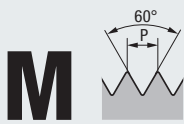

DIN 13

DIN 376

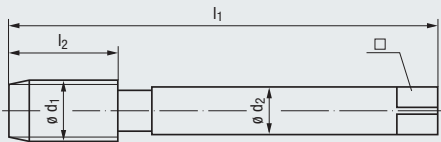

GJV
Cast iron
vermicular

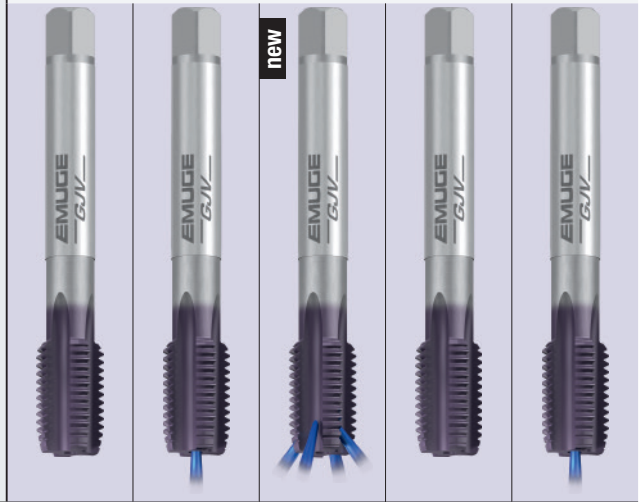

Toleranz · Tolerance
Beschichtung · Coating
Schneidstoff · Cutting material

Technische Informationen
Technical information

» 245 - 266

Schneidstoff · Cutting material



6HX	6HX	6HX	6HX	6HX
TICN	TICN	TICN	TICN	TICN
HSSE-PM	HSSE-PM	HSSE-PM	HSSE-PM	HSSE-PM
C / 2-3	C / 2-3	C / 2-3	E / 1,5-2	E / 1,5-2
E	E	E	E	E

Gewindetiefe und Lochform
Thread depth and hole type

max. 2 x d ₁	max. 2 x d ₁	max. 2 x d ₁	max. 2 x d ₁	max. 2 x d ₁

Einsatzgebiete – Material
Applications – material

» 22

K 1.1-4.2	K 1.1-4.2	K 1.1-4.2	K 1.1-4.2	K 1.1-4.2
-----------	-----------	-----------	-----------	-----------

Werkzeug-Ident · Tool ident





















M	Ø d ₁ mm	P mm	l ₁	l ₂	Ø d ₂	□		Dimens.- Ident	C010R501	C195R501	C106R501	C011R501	C196R501
									Rekord 2A-GJV PM-TICN	Rekord 2A-GJV IKZ-PM TICN	Rekord 2A-GJV IKZN-PM TICN	Rekord 2A-GJV/E PM-TICN	Rekord 2A-GJV/E IKZ-PM TICN
	3	0,5	56	11	2,2	–	2,5	.0030					
	4	0,7	63	13	2,8	2,1	3,3	.0040					
	5	0,8	70	15	3,5	2,7	4,2	.0050					
	6	1	80	17	4,5	3,4	5	.0060					
	7	1	80	17	5,5	4,3	6	.0070					
	8	1,25	90	20	6	4,9	6,8	.0080					
	9	1,25	90	20	7	5,5	7,8	.0090					
	10	1,5	100	22	7	5,5	8,5	.0100					
	11	1,5	100	22	8	6,2	9,5	.0111					
	12	1,75	110	24	9	7	10,2	.0112	●	●	○	●	●
	14	2	110	26	11	9	12	.0114					
	16	2	110	27	12	9	14	.0116	●	●	○	●	●
	18	2,5	125	30	14	11	15,5	.0118					
	20	2,5	140	32	16	12	17,5	.0120		●	○		●
	22	2,5	140	32	18	14,5	19,5	.0122					
	24	3	160	34	18	14,5	21	.0124					
	27	3	160	36	20	16	24	.0127					
	30	3,5	180	40	22	18	26,5	.0130					
	33	3,5	180	40	25	20	29,5	.0133					
	36	4	200	50	28	22	32	.0136					
	39	4	200	50	32	24	35	.0139					
	42	4,5	200	56	32	24	37,5	.0142					
	45	4,5	220	58	36	29	40,5	.0145					
	48	5	250	65	36	29	43	.0148					
	52	5	250	65	40	32	47	.0152					

DIN 371

» 45 » 45 » 45 » 45 » 45

DIN 352

1) Gewindebohren in Durchgangslöcher nur mit externer Kühlschmierung möglich
Threading in through holes is possible only with external cooling/lubrication

GJV Cast iron vermicular		AL Aluminium wrought alloys				TI Titanium			
									
new				new					
6HX		ISO 2/6H	ISO 2/6H	ISO 2/6H	ISO 2/6H	6HX	6HX	6HX	
TICN			GLT-8		GLT-8	NT2	TICN	NT2	
HSSE-PM		HSSE	HSSE	HSSE	HSSE	HSSE	HSSE	HSSE	
E / 1,5-2		B / ≈3	B / ≈3	C / 2-3	C / 2-3	L15	L15	R15	
E		E / 0	E / 0	E / 0	E / 0	D / 4-5	D / 4-5	C / 2-3	
E / 0 / P		E / 0 / P	E / 0 / P	E / 0 / P	E / 0 / P	E / 0 / P	E / 0 / P	E / 0 / P	
max. 2 x d ₁		max. 3 x d ₁	max. 3 x d ₁	max. 2,5 x d ₁	max. 2,5 x d ₁	max. 3 x d ₁	max. 3 x d ₁	max. 2 x d ₁	
									
K 1.1-4.2		N 1.1-4	N 1.1-4	N 1.1-4	N 1.1-4	P 4.1-5.1	P 4.1-5.1	P 4.1-5.1	
						M 3.1-4.1	M 3.1-4.1	M 3.1-4.1	
						N 2.4-5, 2.7	N 2.4-5, 2.7	N 2.4-5, 2.7	
						S 1.1-2.2, 2.4	S 1.1-2.2, 2.4	S 1.1-2.2, 2.4	
C109R501		C0204500	C020S800	C0504500	C050S800	C0306001	C0309601	C0456001	
Rekord 2A-GJV/E IKZN-PM TICN		Rekord 2B-AL	Rekord 2B-AL GLT-8	Enorm 2-AL	Enorm 2-AL GLT-8	Rekord 2C-TI NT2	Rekord 2C-TI TICN	Rekord 2D-TI NT2	
									M 3
									4
									5
									6
									7
									8
									9
									10
									11
○		●	●	●	●	●	●	●	12
○		○	○	○	○	○	○	○	14
○		●	●	●	●	●	●	●	16
									18
○		○	○	○	○	○	○	○	20
									22
									24
									27
									30
									33
									36
									39
									42
									45
									48
									52
 45		 46	 46	 46	 46	 48	 49	 49	

- Product Finder
- V_c
- M
- MF
- UNC UN-8
- UNF
- G, Rp NPSM, NPSF
- NPT, NPTF Rc, W
- BSW, BSF
- Pg
- MJ UNJC, UNJF
- EG (STI) SELF-LOCK
- Tr, Tr-F Rd
- Zubehör Accessories
- Tech. Info

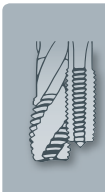

- Product Finder
- Vc
- M
- MF
- UNC UN-8
- UNF UNEF
- G, Rp NPSM, NPSF
- NPT, NPTF Rc, W
- BSW, BSF
- Pg
- MJ UNJC, UNJF
- EG (STI) SELF-LOCK
- Tr, Tr-F Rd
- Zubehör Accessories
- Tech. Info

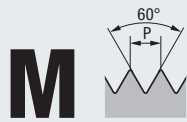

M
DIN 13

DIN 376

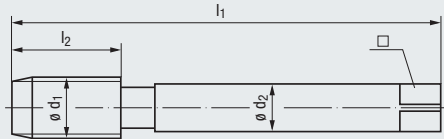

TI
Titanium



NI
Nickel alloys



Technische Informationen
Technical information

Toleranz · Tolerance
Beschichtung · Coating
Schneidstoff · Cutting material



- 6HX
- TICN
- HSSE
- R15
- C / 2-3
- E / O / P

- 6HX
- TICN
- HSSE-PM**
- L08
- D / 4-5
- O / P

- 6HX
- TICN
- HSSE-PM**
- R10
- C / 2-3
- O / P

Gewindetiefe und Lochform
Thread depth and hole type

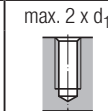
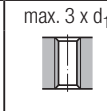
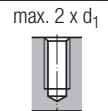

Einsatzgebiete – Material
Applications – material

- P 4.1-5.1**
- M 3.1-4.1**
- N 2.4-5, 2.7**
- S 1.1-2.2, 2.4**

- M 4.1**
- N 2.8**
- S 1.2-3**
- S 2.3, 2.5-6**

- M 4.1**
- N 2.8**
- S 1.2-3**
- S 2.3, 2.5-6**

Werkzeug-Ident · Tool ident

C0459601

C030J401

C438J401

M	Ø d ₁ mm	P mm	l ₁	l ₂	Ø d ₂	□	Dimens.- Ident	Rekord 2D-TI TICN	Rekord 2C-NI-PM TICN	Rekord 2DF-NI-PM TICN
	3	0,5	56	11	2,2	–	2,5	.0030		
	4	0,7	63	13	2,8	2,1	3,3	.0040		
	5	0,8	70	15	3,5	2,7	4,2	.0050		
	6	1	80	17	4,5	3,4	5	.0060		
	7	1	80	17	5,5	4,3	6	.0070		
	8	1,25	90	20	6	4,9	6,8	.0080		
	9	1,25	90	20	7	5,5	7,8	.0090		
	10	1,5	100	22	7	5,5	8,5	.0100		
	11	1,5	100	22	8	6,2	9,5	.0111		
	12	1,75	110	24	9	7	10,2 ²⁾	.0112	●	●
	14	2	110	26	11	9	12 ²⁾	.0114	○	●
	16	2	110	27	12	9	14 ²⁾	.0116	●	●
	18	2,5	125	30	14	11	15,5	.0118	○	●
	20	2,5	140	32	16	12	17,5 ²⁾	.0120	●	●
	22	2,5	140	32	18	14,5	19,5	.0122	○	
	24	3	160	34	18	14,5	21	.0124	●	
	27	3	160	36	20	16	24	.0127		
	30	3,5	180	40	22	18	26,5	.0130		
	33	3,5	180	40	25	20	29,5	.0133		
	36	4	200	50	28	22	32	.0136		
	39	4	200	50	32	24	35	.0139		
	42	4,5	200	56	32	24	37,5	.0142		
	45	4,5	220	58	36	29	40,5	.0145		
	48	5	250	65	36	29	43	.0148		
	52	5	250	65	40	32	47	.0152		

DIN 371

49

49

49

DIN 352

²⁾ Vorbohrdurchmesser für Gewindebohrer Rekord 2A-HCUT-PM-TICN um 0,2 mm anheben
Increase drill diameter for taps Rekord 2A-HCUT-PM-TICN by 0.2 mm

H Materials of high tensile strength						HCUT Hardened steels			
6HX	6HX	6HX	6HX	6HX	6HX	6HX			
NT	TICN	NT	TICN	TICN	KHM	TICN			
HSSE	HSSE	HSSE	HSSE	HSSE		HSSE-PM			
C / 2-3	C / 2-3	C / 2-3	C / 2-3	C / 2-3	C / 2-3	C / 2-3			
E / O / P	E / O / P	E / O	E / O	E / O	E / O	O / P			
max. 2 x d ₁ 		max. 2 x d ₁ 		max. 2 x d ₁ 	max. 2 x d ₁ 	max. 1,5 x d ₁ 			
P 1.1-3.1	P 1.1-4.1	P 1.1-3.1	P 1.1-4.1	P 1.1-4.1	P 5.1	H 1.1-2			
K 1.1-4.2	K 1.1-4.2	K 1.1-4.2	K 1.1-4.2	K 1.1-4.2	K 1.1-4.2				
N 2.4-7	N 2.4-7	N 2.4-7	N 2.4-7	N 2.4-7	N 1.5-6, 2.6-8				
N 4.1, 5.1	N 4.1, 5.1	N 4.1, 5.1	N 4.1, 5.1	N 4.1, 5.1	N 4.1, 4.3-5.2				
					H 1.1-2				
C0100501	C0109101	C1950501	C1959101	C1069101	C1950901	C010J901			
Rekord 2A-H NT	Rekord 2A-H TICN	Rekord 2A-H-IKZ NT	Rekord 2A-H-IKZ TICN	Rekord 2A-H-IKZ TICN	KHM-Rekord 2A-H-IKZ	Rekord 2A-HCUT-PM TICN			
									M 3
									4
									5
									6
									7
									8
									9
									10
									11
●	●	●	●	○	●	●			12
●	●	●	●	○	●	○			14
●	●	●	●	○	●	●			16
○	○	○	○	○	●	●			18
●	●	●	●	○	●	●			20
○	○	○	○	○	●	●			22
●	●	○	○	○	●	●			24
○	○				●				27
○	○								30
○									33
									36
									39
									42
									45
									48
									52
📄 49	📄 50	📄 50	📄 50	📄 50	📄 50	📄 51			

1) Gewindebohren in Durchgangslöchern nur mit externer Kühlschmierung möglich
Threading in through holes is possible only with external cooling/lubrication

Product Finder

V_c

M

MF

UNC UN-8

UNF UNEF

G, Rp NPSM, NPSF

NPT, NPTF Rc, W

BSW, BSF

Pg

MJ UNJC, UNJF

EG (STI) SELF-LOCK

Tr, Tr-F Rd

Zubehör Accessories

Tech. Info



- Product Finder
- V_c
- M
- MF
- UNC UN-8
- UNF UNEF
- G, Rp NPSM, NPSF
- NPT, NPTF Rc, W
- BSW, BSF
- Pg
- MJ UNJC, UNJF
- EG (STI) SELF-LOCK
- Tr, Tr-F Rd
- Zubehör Accessories
- Tech. Info

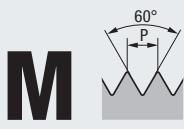

DIN 13

DIN 376

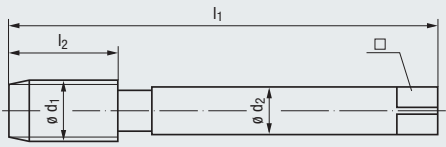

Z
CNC-controlled machines



Toleranz · Tolerance
Beschichtung · Coating
Schneidstoff · Cutting material

Technische Informationen
Technical information
» 245 - 266

6HX	6HX	6HX	6HX	6HX
TICN	TICN	TICN	TICN	TICN
HSSE	HSSE	HSSE	HSSE	HSSE
C / 2-3	C / 2-3	C / 2-3	E / 1,5-2	E / 1,5-2
E / O / P	E / O	E / O	E / O / P	E / O

Gewindetiefe und Lochform
Thread depth and hole type

max. 2 x d ₁	max. 2 x d ₁	max. 2 x d ₁	max. 2 x d ₁	max. 2 x d ₁

Einsatzgebiete – Material
Applications – material
» 22

P 1.1-4.1	P 1.1-4.1	P 1.1-4.1	P 1.1-4.1	P 1.1-4.1
K 1.1-4.2	K 1.1-4.2	K 1.1-4.2	K 1.1-4.2	K 1.1-4.2
N 1.4-6, 2.4-7	N 1.4-6, 2.4-7	N 1.4-6, 2.4-7	N 1.4-6, 2.4-7	N 1.4-6, 2.4-7
N 4.1	N 4.1	N 4.1	N 4.1	N 4.1

Werkzeug-Ident · Tool ident

M	Ø d ₁ mm	P mm	l ₁	l ₂	Ø d ₂	□		Dimens.-Ident	C0109401	C1959401	C1069401	C0119401	C1969401
									Rekord 2A-Z TICN	Rekord 2A-Z-IKZ TICN	Rekord 2A-Z-IKZN TICN	Rekord 2A-Z/E TICN	Rekord 2A-Z/E-IKZ TICN
	3	0,5	56	6	2,2	–	2,5	.0030					
	4	0,7	63	7	2,8	2,1	3,3	.0040					
	5	0,8	70	8	3,5	2,7	4,2	.0050					
	6	1	80	10	4,5	3,4	5	.0060					
	7	1	80	10	5,5	4,3	6	.0070					
	8	1,25	90	14	6	4,9	6,8	.0080					
	9	1,25	90	14	7	5,5	7,8	.0090					
	10	1,5	100	16	7	5,5	8,5	.0100					
	11	1,5	100	18	8	6,2	9,5	.0111					
	12	1,75	110	18	9	7	10,2	.0112	●	●	○	●	●
	14	2	110	20	11	9	12	.0114	●	●	○	●	●
	16	2	110	22	12	9	14	.0116	●	●	○	●	●
	18	2,5	125	25	14	11	15,5	.0118	○	○	○	○	○
	20	2,5	140	25	16	12	17,5	.0120	●	●	○	●	●
	22	2,5	140	27	18	14,5	19,5	.0122					
	24	3	160	30	18	14,5	21	.0124		●	○		
	27	3	160	30	20	16	24	.0127					
	30	3,5	180	35	22	18	26,5	.0130					
	33	3,5	180	35	25	20	29,5	.0133					
	36	4	200	40	28	22	32	.0136					
	39	4	200	40	32	24	35	.0139					
	42	4,5	200	45	32	24	37,5	.0142					
	45	4,5	220	45	36	29	40,5	.0145					
	48	5	250	50	36	29	43	.0148					
	52	5	250	50	40	32	47	.0152					

DIN 371	53	53	53	53	53
DIN 352					

1) Gewindebohren in Durchgangslöcher nur mit externer Kühlschmierung möglich
Threading in through holes is possible only with external cooling/lubrication

Z
CNC-controlled
machines

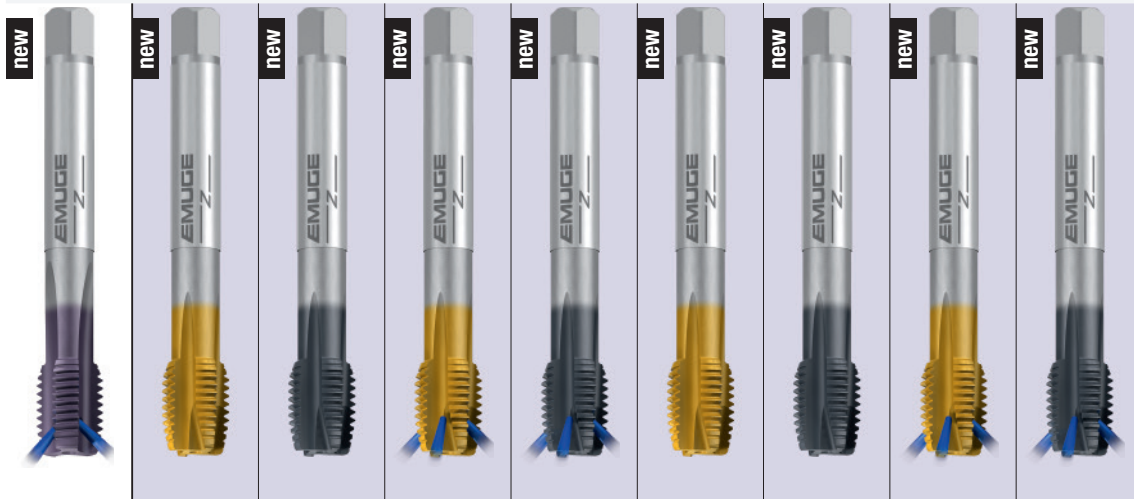

6HX	6HX	6HX	6HX	6HX	6GX	6GX	6GX	6GX
TICN	TIN-70	GLT-1	TIN-70	GLT-1	TIN-70	GLT-1	TIN-70	GLT-1
HSSE	HSSE-PM	HSSE-PM	HSSE-PM	HSSE-PM	HSSE-PM	HSSE-PM	HSSE-PM	HSSE-PM
E / 1,5-2	B / 4-5	B / 4-5	B / 4-5	B / 4-5	B / 4-5	B / 4-5	B / 4-5	B / 4-5
E / O	E / O / P	E / O / P	E / O	E / O	E / O / P	E / O / P	E / O	E / O

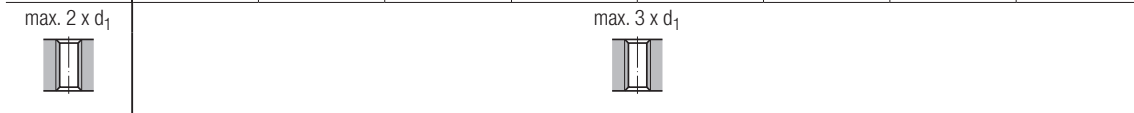

P 1.1-4.1	P 1.1-5.1	P 1.1-5.1	P 1.1-5.1	P 1.1-5.1	P 1.1-5.1	P 1.1-5.1	P 1.1-5.1	P 1.1-5.1
K 1.1-4.2	M 1.1-3.1	M 1.1-3.1	M 1.1-3.1	M 1.1-3.1	M 1.1-3.1	M 1.1-3.1	M 1.1-3.1	M 1.1-3.1
N 1.4-6, 2.4-7	K 2.1	K 2.1	K 2.1	K 2.1	K 2.1	K 2.1	K 2.1	K 2.1
N 4.1	N 1.4-2.2, 2.4-5	N 1.4-2.2, 2.4-5	N 1.4-2.2, 2.4-5	N 1.4-2.2, 2.4-5	N 1.4-2.2, 2.4-5	N 1.4-2.2, 2.4-5	N 1.4-2.2, 2.4-5	N 1.4-2.2, 2.4-5
S 1.1	S 1.1	S 1.1	S 1.1	S 1.1	S 1.1	S 1.1	S 1.1	S 1.1

C1099401	C0208F01	C020A601	C1088F01	C108A601	C0208F21	C020A621	C1088F21	C108A621
Rekord 2A-Z/E-1KZN TICN	Rekord 2B-Z-PM TIN-70	Rekord 2B-Z-PM GLT-1	Rekord 2B-Z-1KZN PM-TIN-70	Rekord 2B-Z-1KZN PM-GLT-1	Rekord 2B-Z-PM TIN-70 „6GX“	Rekord 2B-Z-PM GLT-1 „6GX“	Rekord 2B-Z-1KZN PM-TIN-70 „6GX“	Rekord 2B-Z-1KZN PM-GLT-1 „6GX“

										M	3
											4
											5
											6
											7
											8
											9
											10
											11
○	●	●	○	○	●	●	○	○			12
○	●	●	○	○	○	○	○	○			14
○	○	●	○	○	○	○	○	○			16
○	○	○	○	○	○	○	○	○			18
○	○	○	○	○	○	○	○	○			20
	○	○	○	○	○	○	○	○			22
	●	●	○	○	●	●	○	○			24
											27
	●	●									30
											33
											36
											39
											42
											45
											48
											52

54	54	54	54	54	55	55	55	55
----	----	----	----	----	----	----	----	----

- Product Finder
- V_c
- M
- MF
- UNC UN-8
- UNF
- G, Rp NPSM, NPSF
- NPT, NPTF Rc, W
- BSW, BSF
- Pg
- MJ UNJC, UNJF
- EG (ST) SELF-LOCK
- Tr, Tr-F Rd
- Zubehör Accessories
- Tech. Info



● = Lagerwerkzeug, siehe Preisliste · Stock tool, see price list
○ = Kurzfristig lieferbar, Preis auf Anfrage · Available on short notice, price upon inquiry

- Product Finder
- V_c
- M
- MF
- UNC UN-8
- UNF UNEF
- G, Rp NPSM, NPSF
- NPT, NPTF Rc, W
- BSW, BSF
- Pg
- MJ UNJC, UNJF
- EG (STI) SELF-LOCK
- Tr, Tr-F Rd
- Zubehör Accessories
- Tech. Info



DIN 13

DIN 376

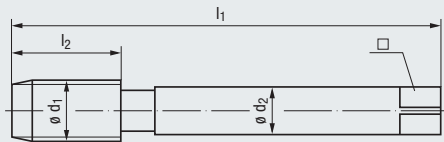

Z
CNC-controlled machines

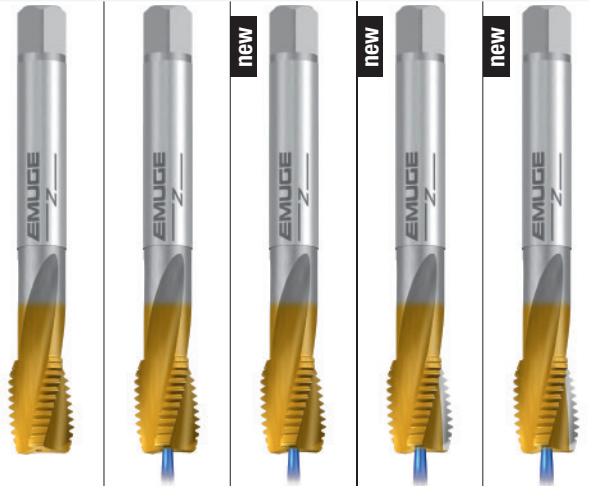

Toleranz · Tolerance
Beschichtung · Coating
Schneidstoff · Cutting material

Technische Informationen
Technical information

» 245 - 266

6HX	6HX	6HX	6HX	6HX
TIN	TIN	TIN	TIN	TIN
HSSE	HSSE	HSSE	HSSE	HSSE
R15	R15	R15	R15	R15
C / 2-3	C / 2-3	E / 1,5-2	C / 2-3	E / 1,5-2
E / O / P	E / O	E / O	E / O	E / O

Gewindetiefe und Lochform
Thread depth and hole type

max. 2 x d₁



Einsatzgebiete – Material
Applications – material

» 22

P 2.1-5.1	P 2.1-5.1	P 2.1-5.1	P 2.1-5.1	P 2.1-5.1
K 2.1-2	K 2.1-2	K 2.1-2	K 2.1-2	K 2.1-2
N 1.4-6, 2.4-5	N 1.4-6, 2.4-5	N 1.4-6, 2.4-5	N 1.4-6, 2.4-5	N 1.4-6, 2.4-5

Werkzeug-Ident · Tool ident

C0453701 C0963701 C0983701 C4253701 C4053701

M	∅ d ₁ mm	P mm	l ₁	l ₂	∅ d ₂	□	Dimens.- Ident	Rekord	Rekord	Rekord	Rekord	Rekord
								2D-Z TIN	2D-Z- IKZ TIN	2D-Z/E- IKZ TIN	2D-Z-BF IKZ-TIN	2D-Z-E-BF IKZ-TIN
	3	0,5	56	6	2,2	–	.0030					
	4	0,7	63	7	2,8	2,1	.0040					
	5	0,8	70	8	3,5	2,7	.0050					
	6	1	80	10	4,5	3,4	.0060					
	7	1	80	10	5,5	4,3	.0070					
	8	1,25	90	14	6	4,9	.0080					
	9	1,25	90	14	7	5,5	.0090					
	10	1,5	100	16	7	5,5	.0100					
	11	1,5	100	18	8	6,2	.0111					
	12	1,75	110	18	9	7	.0112	●	●	●	●	●
	14	2	110	20	11	9	.0114		○		○	
	16	2	110	22	12	9	.0116	●	●	●	●	●
	18	2,5	125	25	14	11	.0118		○		○	
	20	2,5	140	25	16	12	.0120	●	●	●	●	●
	22	2,5	140	27	18	14,5	.0122				○	
	24	3	160	30	18	14,5	.0124		●		○	
	27	3	160	30	20	16	.0127		○		○	
	30	3,5	180	35	22	18	.0130		●		○	
	33	3,5	180	35	25	20	.0133					
	36	4	200	40	28	22	.0136					
	39	4	200	40	32	24	.0139					
	42	4,5	200	45	32	24	.0142					
	45	4,5	220	45	36	29	.0145					
	48	5	250	50	36	29	.0148					
	52	5	250	50	40	32	.0152					

DIN 371

» 55 » 55 » 55 » 55 » 55

DIN 352

Z
CNC-controlled
machines

new	new	new	new	new	new	new	new	new	new
6HX	6HX	6HX	6HX	6HX	6HX	6HX	6HX	6GX	6GX
TIN-60	GLT-1	TIN-60	GLT-1	TIN-60	GLT-1	TIN-60	GLT-1	TIN-60	GLT-1
HSSE-PM	HSSE-PM	HSSE-PM	HSSE-PM	HSSE-PM	HSSE-PM	HSSE-PM	HSSE-PM	HSSE-PM	HSSE-PM
R45	R45	R45	R45	R45	R45	R45	R45	R45	R45
C / 2-3	C / 2-3	C / 2-3	C / 2-3	E / 1,5-2	E / 1,5-2	E / 1,5-2	E / 1,5-2	C / 2-3	C / 2-3
E / O / P	E / O / P	E / O	E / O	E / O / P	E / O / P	E / O	E / O	E / O / P	E / O / P

max. 3 x d₁



P 2.1-4.1	P 2.1-4.1	P 2.1-4.1	P 2.1-4.1	P 2.1-4.1	P 2.1-4.1	P 2.1-4.1	P 2.1-4.1	P 2.1-4.1	P 2.1-4.1
M 1.1-3.1	M 1.1-3.1	M 1.1-3.1	M 1.1-3.1	M 1.1-3.1	M 1.1-3.1	M 1.1-3.1	M 1.1-3.1	M 1.1-3.1	M 1.1-3.1
K 2.1	K 2.1	K 2.1	K 2.1	K 2.1	K 2.1	K 2.1	K 2.1	K 2.1	K 2.1
N 1.4-2.2, 2.4-5	N 1.4-2.2, 2.4-5	N 1.4-2.2, 2.4-5	N 1.4-2.2, 2.4-5	N 1.4-2.2, 2.4-5	N 1.4-2.2, 2.4-5	N 1.4-2.2, 2.4-5	N 1.4-2.2, 2.4-5	N 1.4-2.2, 2.4-5	N 1.4-2.2, 2.4-5
S 1.1	S 1.1	S 1.1	S 1.1	S 1.1	S 1.1	S 1.1	S 1.1	S 1.1	S 1.1
C5760F01	C576A601	C5810F01	C581A601	C5820F01	C582A601	C5830F01	C583A601	C5760F21	C576A621
Enorm 2-Z-X-PM TIN-60	Enorm 2-Z-X-PM GLT-1	Enorm 2-Z-X IKZ-PM TIN-60	Enorm 2-Z-X IKZ-PM GLT-1	Enorm 2-Z/E-X-PM TIN-60	Enorm 2-Z/E-X-PM GLT-1	Enorm 2-Z/E-X IKZ-PM TIN-60	Enorm 2-Z/E-X IKZ-PM GLT-1	Enorm 2-Z-X-PM TIN-60 „6GX“	Enorm 2-Z-X-PM GLT-1 „6GX“

										M	3
											4
											5
											6
											7
											8
											9
											10
											11
●	●	●	●	●	●	●	●	●	●		12
●	●	●	●	●	●	●	●	●	●		14
●	●	●	●	●	●	●	●	●	●		16
											18
●	●	●	●	●	●	●	●	●	●		20
											22
●	●	●	●	●	●	●	●	●	●		24
											27
●	●	●	●	●	●	●	●	●	●		30
											33
											36
											39
											42
											45
											48
											52
📄 56	📄 56	📄 56	📄 56	📄 56	📄 57	📄 57	📄 57	📄 57	📄 57		

Product Finder

V_c

M

MF

UNC UN-8

UNF UNEF

G, Rp NPSM, NPSF

NPT, NPTF Rc, W

BSW, BSF

Pg

MJ UNJC, UNJF

EG (ST) SELF-LOCK

Tr, Tr-F Rd

Zubehör Accessories

Tech. Info



- Product Finder
- V_c
- M
- MF
- UNC UN-8
- UNF UNEF
- G, Rp NPSM, NPSF
- NPT, NPTF Rc, W
- BSW, BSF
- Pg
- MJ UNJC, UNJF
- EG (STI) SELF-LOCK
- Tr, Tr-F Rd
- Zubehör Accessories
- Tech. Info

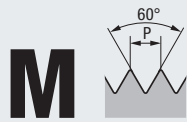

DIN 13

DIN 376

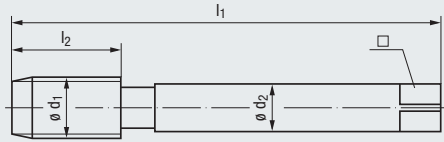

Toleranz · Tolerance
Beschichtung · Coating
Schneidstoff · Cutting material

Technische Informationen
Technical information

» 245 - 266



Z
CNC-controlled machines



6GX	6GX	6GX	6GX	6GX
TIN-60	GLT-1	TIN-60	GLT-1	TIN-60
HSSE-PM	HSSE-PM	HSSE-PM	HSSE-PM	HSSE-PM
R45	R45	R45	R45	R45
C / 2-3	C / 2-3	E / 1,5-2	E / 1,5-2	E / 1,5-2
E / 0	E / 0	E / 0 / P	E / 0 / P	E / 0

Gewindetiefe und Lochform
Thread depth and hole type

max. 3 x d₁



Einsatzgebiete – Material
Applications – material

» 22

P 2.1-4.1	P 2.1-4.1	P 2.1-4.1	P 2.1-4.1	P 2.1-4.1
M 1.1-3.1	M 1.1-3.1	M 1.1-3.1	M 1.1-3.1	M 1.1-3.1
K 2.1	K 2.1	K 2.1	K 2.1	K 2.1
N 1.4-2.2, 2.4-5	N 1.4-2.2, 2.4-5	N 1.4-2.2, 2.4-5	N 1.4-2.2, 2.4-5	N 1.4-2.2, 2.4-5
S 1.1	S 1.1	S 1.1	S 1.1	S 1.1

Werkzeug-Ident · Tool ident

M	Ø d ₁ mm	P mm	l ₁	l ₂	Ø d ₂	□	Dimens.- Ident	Enorm 2-Z-X- IKZ	Enorm 2-Z-X- IKZ	Enorm 2-Z/E-X- PM	Enorm 2-Z/E-X- PM	Enorm 2-Z/E-X- IKZ
								PM-TIN-60 „6GX“	PM-GLT-1 „6GX“	TIN-60 „6GX“	GLT-1 „6GX“	PM-TIN-60 „6GX“
	3	0,5	56	6	2,2	–	.0030					
	4	0,7	63	7	2,8	2,1	.0040					
	5	0,8	70	8	3,5	2,7	.0050					
	6	1	80	10	4,5	3,4	.0060					
	7	1	80	10	5,5	4,3	.0070					
	8	1,25	90	14	6	4,9	.0080					
	9	1,25	90	14	7	5,5	.0090					
	10	1,5	100	16	7	5,5	.0100					
	11	1,5	100	18	8	6,2	.0111					
	12	1,75	110	18	9	7	.0112	●	●	●	●	●
	14	2	110	20	11	9	.0114					
	16	2	110	22	12	9	.0116	●	●	●	●	●
	18	2,5	125	25	14	11	.0118					
	20	2,5	140	25	16	12	.0120	●	●	●	●	●
	22	2,5	140	27	18	14,5	.0122					
	24	3	160	30	18	14,5	.0124	●	●	●	●	●
	27	3	160	30	20	16	.0127					
	30	3,5	180	35	22	18	.0130	●	●	●	●	●
	33	3,5	180	35	25	20	.0133					
	36	4	200	40	28	22	.0136					
	39	4	200	40	32	24	.0139					
	42	4,5	200	45	32	24	.0142					
	45	4,5	220	45	36	29	.0145					
	48	5	250	50	36	29	.0148					
	52	5	250	50	40	32	.0152					

DIN 371

» 57

» 57

» 57

» 57

» 57

DIN 352

Z
CNC-controlled
machines

new										
	6GX	ISO 2/6H	ISO 2/6H	ISO 2/6H	ISO 2/6H	ISO 2/6H	ISO 2/6H	ISO 2/6H	ISO 2/6H	ISO 3/6G
	GLT-1		TIN	GLT-1	GLT-1		TIN	GLT-1	TIN	
	HSSE-PM	HSSE	HSSE	HSSE	HSSE	HSSE	HSSE	HSSE	HSSE	HSSE
	R45	R45	R45	R45	R45	R45	R45	R45	R45	R45
	E / 1,5-2	C / 2-3	C / 2-3	C / 2-3	C / 2-3	E / 1,5-2	E / 1,5-2	E / 1,5-2	E / 1,5-2	E / 1,5-2
E / 0	E / 0 / P	E / 0 / P	E / 0 / P	E / 0	E / 0 / P	E / 0 / P	E / 0 / P	E / 0	E / 0 / P	

max. 3 x d₁



P 2.1-4.1	P 1.1-4.1	P 1.1-4.1	P 1.1-4.1	P 1.1-4.1	P 1.1-4.1	P 1.1-4.1	P 1.1-4.1	P 1.1-4.1	P 1.1-4.1	P 1.1-4.1
M 1.1-3.1	M 1.1-2.1	M 1.1-3.1	M 1.1-3.1	M 1.1-3.1	M 1.1-2.1	M 1.1-3.1	M 1.1-3.1	M 1.1-3.1	M 1.1-3.1	M 1.1-2.1
K 2.1	N 2.1	N 1.4-6	N 1.4-6	N 1.4-6	N 2.1	N 1.4-6	N 1.4-6	N 1.4-6	N 1.4-6	N 2.1
N 1.4-2.2, 2.4-5		N 2.1-2, 2.4-5	N 2.1-2, 2.4-5	N 2.1-2, 2.4-5		N 2.1-2, 2.4-5	N 2.1-2, 2.4-5	N 2.1-2, 2.4-5	N 2.1-2, 2.4-5	
S 1.1		S 1.1	S 1.1	S 1.1		S 1.1	S 1.1	S 1.1	S 1.1	
C583A621	C0503500	C0503700	C050C400	C099C400	C0513500	C0513700	C051C400	C0973700	C0513520	
Enorm 2-Z/E-X- IKZ PM-GLT-1 „6GX“	Enorm 2-Z	Enorm 2-Z TIN	Enorm 2-Z GLT-1	Enorm 2-Z- IKZ GLT-1	Enorm 2-Z/E	Enorm 2-Z/E TIN	Enorm 2-Z/E GLT-1	Enorm 2-Z/E- IKZ TIN	Enorm 2-Z/E „6G“	
										M 3
										4
										5
										6
										7
										8
										9
										10
●	●	●	●	●	●	●	●	●	●	11
●	●	○	○	●	●	○	●	●	○	12
●	●	○	○	●	●	○	●	●	○	14
●	●	○	○	●	●	○	●	●	○	16
●	●	○	○	●	●	○	●	●	○	18
●	●	○	○	●	●	○	●	●	○	20
●	●	○	○	●	●	○	●	●	○	22
●	○	○	○	●	○	○	○	○	○	24
	○				○					27
	○				○					30
	○				○					33
	○				○					36
	○				○					39
	○				○					42
	○				○					45
	○				○					48
					○					52
📄 58	📄 58	📄 58	📄 58	📄 58	📄 59	📄 59	📄 59	📄 59	📄 59	
	📄 91									

Product Finder

V_c

M

MF

UNC UN-8

UNF UNEF

G, Rp NPSM, NPSF

NPT, NPTF Rc, W

BSW, BSF

Pg

MJ UNJC, UNJF

EG (ST) SELF-LOCK

Tr, Tr-F Rd

Zubehör Accessories

Tech. Info



- Product Finder
- Vc
- M
- MF
- UNC UN-8
- UNF UNEF
- G, Rp NPSM, NPSF
- NPT, NPTF Rc, W
- BSW, BSF
- Pg
- MJ UNJC, UNJF
- EG (STI) SELF-LOCK
- Tr, Tr-F Rd
- Zubehör Accessories
- Tech. Info



DIN 13

DIN 376

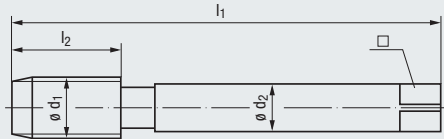

Z
CNC-controlled machines



Toleranz · Tolerance
Beschichtung · Coating
Schneidstoff · Cutting material

Technische Informationen
Technical information

» 245 - 266

ISO 3/6G	6HX	6HX	6H +0,1 2)
TIN		TIN	
HSSE	HSSE	HSSE	HSSE
R45	R50	R50	R50
E / 1,5-2	C / 2-3	C / 2-3	C / 2-3
E / O / P	E / O / P	E / O / P	E / O / P

Gewindetiefe und Lochform
Thread depth and hole type

max. 3 x d₁



Einsatzgebiete – Material
Applications – material

» 22

P 1.1-4.1	P 1.1-4.1	P 1.1-4.1	P 1.1-4.1
M 1.1-3.1	M 1.1-2.1	M 1.1-3.1	M 1.1-2.1
N 1.4-6	N 2.1	N 1.4-6	N 2.1
N 2.1-2, 2.4-5		N 2.1-2, 2.4-5	
S 1.1		S 1.1	

Werkzeug-Ident · Tool ident

C0513720 C0653501 C0653701 C0653540

M	Ø d ₁ mm	P mm	l ₁	l ₂	Ø d ₂	□	Dimens.- Ident	Enorm	Enorm	Enorm	Enorm
								2-Z/E TIN „6G“	2-Z50	2-Z50 TIN	2-Z50
	3	0,5	56	6	2,2	–	.0030				
	4	0,7	63	7	2,8	2,1	.0040				
	5	0,8	70	8	3,5	2,7	.0050				
	6	1	80	10	4,5	3,4	.0060				●
	7	1	80	10	5,5	4,3	.0070				●
	8	1,25	90	14	6	4,9	.0080				●
	9	1,25	90	14	7	5,5	.0090				●
	10	1,5	100	16	7	5,5	.0100				●
	11	1,5	100	18	8	6,2	.0111				●
	12	1,75	110	18	9	7	.0112	●	●	●	●
	14	2	110	20	11	9	.0114	○			
	16	2	110	22	12	9	.0116	●	●	●	●
	18	2,5	125	25	14	11	.0118	○			
	20	2,5	140	25	16	12	.0120	●	●	●	●
	22	2,5	140	27	18	14,5	.0122				
	24	3	160	30	18	14,5	.0124				○
	27	3	160	30	20	16	.0127				
	30	3,5	180	35	22	18	.0130				
	33	3,5	180	35	25	20	.0133				
	36	4	200	40	28	22	.0136				
	39	4	200	40	32	24	.0139				
	42	4,5	200	45	32	24	.0142				
	45	4,5	220	45	36	29	.0145				
	48	5	250	50	36	29	.0148				
	52	5	250	50	40	32	.0152				

DIN 371

» 59

» 59

» 59

» 59

DIN 352

2) Vorbohrdurchmesser für Gewindebohrer mit Übermaß um 0,1 mm anheben
Increase drill diameter for taps with oversize by 0.1 mm

SPEED
High-speed
cutting



6HX	6HX	6HX	6HX	6HX	6HX	6HX	6HX
TICN	TICN	TICN	TICN	TIN-70	TIN-70	TIN-60	TIN-60
HSSE	HSSE	HSSE	HSSE	HSSE-PM	HSSE-PM	HSSE-PM	HSSE-PM
C / 2-3	C / 2-3	E / 1,5-2	E / 1,5-2	B / 4-5	B / 4-5	C / 2-3	C / 2-3
E	E	E	E	E	E	E	E

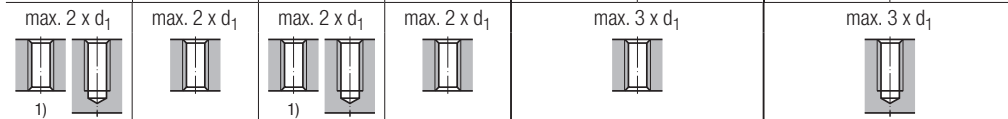

K 1.1-4.2	K 1.1-4.2	K 1.1-4.2	K 1.1-4.2	P 1.1-4.1	P 1.1-4.1	P 2.1-4.1	P 2.1-4.1
N 1.4-6	N 1.4-6	N 1.4-6	N 1.4-6	K 2.1-2	K 2.1-2		
				N 1.4-6	N 1.4-6		

C3159401	C3179401	C3169401	C3189401	C3208F01	C3258F01	C3600F01	C3650F01
Rekord 2A-SPEED IKZ-TICN	Rekord 2A-SPEED IKZN-TICN	Rekord 2A-SPEED/E IKZ-TICN	Rekord 2A-SPEED/E IKZN-TICN	Rekord 2B-Z-SPEED PM-TIN-70	Rekord 2B-Z-SPEED IKZN-PM TIN-70	Enorm 2-Z-SPEED X-PM TIN-60	Enorm 2-Z-SPEED X-PM TIN-60

										M	3
											4
											5
											6
											7
											8
											9
											10
											11
●	○	●	○	●	○	●	●				12
●	○	●	○	●	○	●	●				14
●	○	●	○	●	○	●	●				16
○	○	○	○	○	○	○	○				18
●	○	●	○	●	○	●	●				20
											22
											24
											27
											30
											33
											36
											39
											42
											45
											48
											52
60	60	60	60	61	61	61	61				

1) Gewindebohren in Durchgangslöchern nur mit externer Kühlschmierung möglich
Threading in through holes is possible only with external cooling/lubrication

Product Finder

Vc

M

MF

UNC UN-8

UNF UNEF

G, Rp NPSM, NPSF

NPT, NPTF Rc, W

BSW, BSF

Pg

MJ UNJC, UNJF

EG (STI) SELF-LOCK

Tr, Tr-F Rd

Zubehör Accessories

Tech. Info



- Product Finder
- Vc
- M
- MF
- UNC UN-8
- UNF UNEF
- G, Rp NPSM, NPSF
- NPT, NPTF Rc, W
- BSW, BSF
- Pg
- MJ UNJC, UNJF
- EG (STI) SELF-LOCK
- Tr, Tr-F Rd
- Zubehör Accessories
- Tech. Info

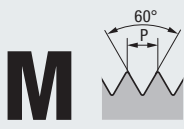

DIN 13

DIN 376

Mit Spanglocke
With internal chip collector

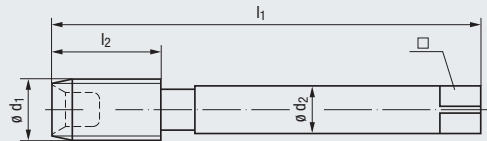

VA
Stainless steel materials

Toleranz · Tolerance
Beschichtung · Coating
Schneidstoff · Cutting material

Technische Informationen
Technical information

» 245 - 266

- | | |
|----------|----------|
| NE2 | 6HX |
| HSSE | NE2 |
| C / 2-3 | HSSE |
| P / O 1) | C / 2-3 |
| | P / O 1) |

Gewindetiefe und Lochform
Thread depth and hole type

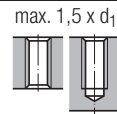

Einsatzgebiete – Material
Applications – material

» 22

- | | |
|------------------|------------------|
| P 1.1-4.1 | P 1.1-4.1 |
| M 1.1-2.1 | M 1.1-2.1 |
| K 1.1-4.2 | K 1.1-4.2 |

Werkzeug-Ident · Tool ident									C0803009	C0803001
Ø d ₁ mm	P mm	l ₁	l ₂	Ø d ₂	□		Dimens.- Ident	Robust 2X-VA V-Nr.1 NE2	Robust 2X-VA NE2	
M 20	2,5	140	32	16	12	17,5	.0120		●	
22	2,5	140	32	18	14,5	19,5	.0122		●	
24	3	160	34	18	14,5	21	.0124		●	
27	3	160	36	20	16	24	.0127		●	
30	3,5	180	40	22	18	26,5	.0130		●	
33	3,5	180	40	25	20	29,5	.0133		●	
36	4	200	50	28	22	32	.0136		●	
39	4	200	50	32	24	35	.0139		●	
42	4,5	200	56	32	24	37,5	.0142		●	
45	4,5	220	58	36	29	40,5	.0145		●	
48	5	250	65	36	29	43	.0148		●	
52	5	250	65	40	32	47	.0152	●	●	
56	5,5	250	70	40	32	50,5	.0156	●	●	
60	5,5	280	70	45	35	54,5	.0160	●	●	
64	6	315	75	50	39	58	.0164	●	●	
68	6	315	75	50	39	62	.0168	●	●	

1) Bevorzugt mit Pastenschmierung einsetzen, neben Werkzeug auch Bohrungswandung einstreichen.
Ölschmierung ist nur bei senkrechter Grundlochbearbeitung möglich, wenn das Grundloch mit Öl vollgefüllt ist.
If possible, use paste lubrication, coating both the tool and the walls of the drilled hole.
Lubrication with oil is possible only in the vertical machining of blind holes, if the hole is entirely filled with oil.

≥ M56 Schaft mit Griffrielen!
≥ M56 Shank with grooves for better handling!

2) Robust 2X-VA-NE2 kann auch im Satz als Fertigschneider benutzt werden.
Hierbei kann eine Gewindetiefe von bis zu 3 x d₁ hergestellt werden.
Robust 2X-VA-NE2 can also be used as finishing taps in a set of taps.
In this way, thread depths of up to 3 x d₁ can be produced.

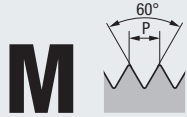

DIN 13

DIN 376

Mit Spanglocke
With internal chip collector

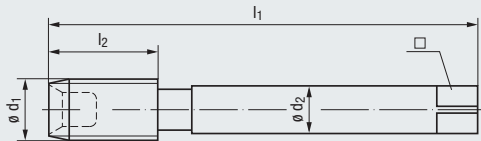

Technische Informationen
Technical information

» 245 - 266

Toleranz · Tolerance
Beschichtung · Coating
Schneidstoff · Cutting material



Gewindetiefe und Lochform
Thread depth and hole type

max. 1,5 x d₁

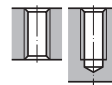

Einsatzgebiete – Material
Applications – material

» 22

Werkzeug-Ident · Tool ident

									C0803109	C0803101
									Robust 2X-VA V-Nr.1 TIN	Robust 2X-VA TIN
Ø d ₁ mm	P mm	l ₁	l ₂	Ø d ₂	□		Dimens.-Ident			
M 20	2,5	140	32	16	12	17,5	.0120		○	
22	2,5	140	32	18	14,5	19,5	.0122		○	
24	3	160	34	18	14,5	21	.0124		○	
27	3	160	36	20	16	24	.0127		○	
30	3,5	180	40	22	18	26,5	.0130		○	
33	3,5	180	40	25	20	29,5	.0133		○	
36	4	200	50	28	22	32	.0136		○	
39	4	200	50	32	24	35	.0139		○	
42	4,5	200	56	32	24	37,5	.0142		○	
45	4,5	220	58	36	29	40,5	.0145		○	
48	5	250	65	36	29	43	.0148		○	
52	5	250	65	40	32	47	.0152	○	○	
56	5,5	250	70	40	32	50,5	.0156	○	○	
60	5,5	280	70	45	35	54,5	.0160	○	○	
64	6	315	75	50	39	58	.0164	○	○	
68	6	315	75	50	39	62	.0168	○	○	

1) Bevorzugt mit Pastenschmierung einsetzen, neben Werkzeug auch Bohrungswandung einstreichen.
Ölschmierung ist nur bei senkrechter Grundlochbearbeitung möglich, wenn das Grundloch mit Öl vollgefüllt ist.
If possible, use paste lubrication, coating both the tool and the walls of the drilled hole.
Lubrication with oil is possible only in the vertical machining of blind holes, if the hole is entirely filled with oil.

≥ M56 Schaft mit Griffriellen!
≥ M56 Shank with grooves for better handling!

2) Robust 2X-VA-TIN kann auch im Satz als Fertigschneider benutzt werden.
Hierbei kann eine Gewindetiefe von bis zu 3 x d₁ hergestellt werden.
Robust 2X-VA-TIN can also be used as finishing taps in a set of taps.
In this way, thread depths of up to 3 x d₁ can be produced.

- Product Finder
- V_c
- M
- MF
- UNC UN-8
- UNF UNEF
- G, Rp NPSM, NPSF
- NPT, NPTF Rc, W
- BSW, BSF
- Pg
- MJ UNJC, UNJF
- EG (ST) SELF-LOCK
- Tr, Tr-F Rd
- Zubehör Accessories
- Tech. Info

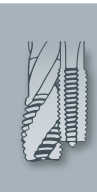

- Product Finder
- Vc
- M
- MF
- UNC UN-8
- UNF UNEF
- G, Rp NPSM, NPSF
- NPT, NPTF Rc, W
- BSW, BSF
- Pg
- MJ UNJC, UNJF
- EG (STI) SELF-LOCK
- Tr, Tr-F Rd
- Zubehör Accessories
- Tech. Info

M



DIN 13

Mit extra langem Schaft
With extra long shank

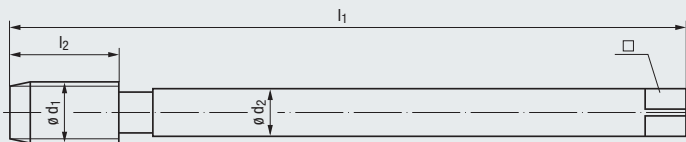

STEEL
Steel materials



Toleranz · Tolerance
Beschichtung · Coating
Schneidstoff · Cutting material

Technische Informationen
Technical information

» 245 - 266

ISO 2/6H	ISO 2/6H	ISO 2/6H	ISO 2/6H
HSSE	HSSE	HSSE	HSSE
B / 4-5	E / 1,5-2	C / 2-3	C / 2-3
E / 0	E / 0	E / 0	E / 0

Gewindetiefe und Lochform
Thread depth and hole type

max. 3 x d ₁	max. 2 x d ₁	max. 2,5 x d ₁	

Einsatzgebiete – Material
Applications – material

» 22

P 2.1-4.1	P 2.1-3.1	P 1.1-4.1 K 1.1-4.2 N 1.4-5, 2.4-5	P 1.1-3.1 N 2.2
-----------	-----------	--	--------------------

Werkzeug-Ident · Tool ident











Ø d ₁ mm	P mm	l ₁	l ₂	Ø d ₂	□		Dimens.- Ident	C2201000	C2461000	C2401400	C2501000
								Rekord 2B-STEEL-M LS	Rekord 2D-STEEL/E LS	Rekord 2DF-STEEL LS-TIN	Enorm 2-STEEL-LS
M 6	1	160	17	4,5	3,4	5	.0060	●	●		●
8	1,25	180	20	6	4,9	6,8	.0080	●	●		●
10	1,5	200	22	7	5,5	8,5	.0100	●	●		●
12	1,75	224	24	9	7	10,2	.0112	●	●	●	●
14	2	224	26	11	9	12	.0114	●	●		●
16	2	224	27	12	9	14	.0116	●	●	●	●
18	2,5	250	30	14	11	15,5	.0118	●	●		●
20	2,5	280	32	16	12	17,5	.0120	●	●		●



62 62 62 62

1) Auch mit innerer Kühlschmierstoff-Zufuhr IKZ möglich
Also available with internal coolant supply IKZ

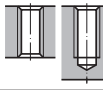
2) Auch mit innerer Kühlschmierstoff-Zufuhr IKZN möglich
Also available with internal coolant supply IKZN

VA Stainless steel materials				H Materials of high tensile strength	Z CNC-controlled machines			
	new 		new 		new 			
2)		1)	1)	1) 2)	1) 2)			
ISO 2/6H	ISO 2/6H	ISO 2/6H	ISO 2/6H	6HX	6HX			
NT	GLT-1		GLT-1	NT	TIN			
HSSE	HSSE	HSSE	HSSE	HSSE	HSSE			
		R35	R35		R15			
B / 4-5	B / 4-5	C / 2-3	C / 2-3	C / 2-3	C / 2-3			
E / O / P	E / O / P	E / O / P	E / O / P	E / O / P	E / O			
max. 3 x d ₁		max. 2,5 x d ₁		max. 2 x d ₁				
								
P 1.1-3.1	P 1.1-4.1	P 1.1-3.1	P 1.1-4.1	P 1.1-3.1	P 2.1-5.1			
M 1.1-2.1	M 1.1-3.1	M 1.1-2.1	M 1.1-3.1	K 1.1-4.2	K 2.1-2			
K 2.1	K 2.1	K 2.1	K 2.1	N 2.4-7	N 1.4-6, 2.4-5			
N 2.2, 2.5-6	N 2.2			N 4.1, 5.1				
C2203000	C220C300	C2503000	C250C300	C2100501	C4093701			
Rekord 2B-VA-LS NT	Rekord 2B-VA-LS GLT-1	Enorm 2-VA-LS	Enorm 2-VA-LS GLT-1	Rekord 2A-H-LS NT	Rekord 2D-Z-BF IKZ-LS TIN			
●	○	●	○	●				M 6
●	○	●	○	●				8
●	○	●	○	●				10
●	○	●	○	●		○		12
●	○	●	○	●				14
●	○	●	○	●		○		16
●	○	●	○	●				18
●	○	●	○	●				20
63	63	63	63	63	63			

- Product Finder
- V_c
- M
- MF
- UNC UN-8
- UNF UNEF
- G, Rp NPSM, NPSF
- NPT, NPTF Rc, W
- BSW, BSF
- Pg
- MJ UNJC, UNJF
- EG (STI) SELF-LOCK
- Tr, Tr-F Rd
- Zubehör Accessories
- Tech. Info



- Product Finder
- Vc
- M
- MF
- UNC UN-8
- UNF UNEF
- G, Rp NPSM, NPSF
- NPT, NPTF Rc, W
- BSW, BSF
- Pg
- MJ UNJC, UNJF
- EG (STI) SELF-LOCK
- Tr, Tr-F Rd
- Zubehör Accessories
- Tech. Info

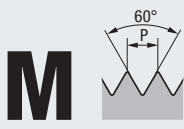

DIN 13

Mit langen Nuten und langem Schaft für Gewindetiefen bis max. 3 x d₁
 With long flutes and long shank for thread depths up to max. 3 x d₁

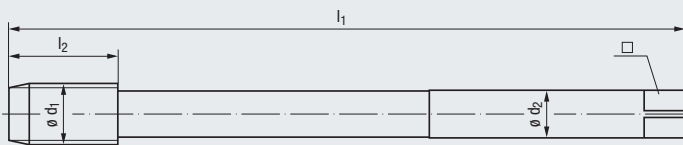

Technische Informationen Technical information	Toleranz · Tolerance Beschichtung · Coating Schneidstoff · Cutting material	6HX	6HX	6HX
		TICN	TIN	TIN
» 245 - 266		HSSE	HSSE	HSSE
		C / 2-3	C / 2-3	C / 2-3
		E / O	E / O	E / O

Gewindetiefe und Lochform Thread depth and hole type	max. 3 x d ₁ 	max. 3 x d ₁ 	
---	-----------------------------	-----------------------------	--

Einsatzgebiete – Material Applications – material	» 22	P 1.1-4.1 K 1.1-4.2 N 1.4-6, 2.4-7 N 4.1	P 2.1-5.1 K 2.1-2 N 1.4-6, 2.4-5	P 2.1-5.1 K 2.1-2 N 1.4-6, 2.4-5
--	------	---	---	---

Werkzeug-Ident · Tool ident								C0579401	C4963701	C4973701
Ø d ₁ mm	P mm	l ₁	l ₂	Ø d ₂	□		Dimens.- Ident	Rekord 2A-Z-1KZ-LF3 TICN	Rekord 2D-Z-1KZ-LF3 TIN	Rekord 2D-Z-BF-1KZ-LF3 TIN
M 24	3	215	30	18	14,5	21	.0124	●	●	○
30	3,5	240	35	22	18	26,5	.0130	●	●	○
33	3,5	255	35	25	20	29,5	.0133	●	●	○
36	4	275	40	28	22	32	.0136	●	●	○
42	4,5	295	45	32	24	37,5	.0142	●	●	○

1) Gewindebohren in Durchgangslöcher nur mit externer Kühlschmierung möglich
 Threading in through holes is possible only with external cooling/lubrication

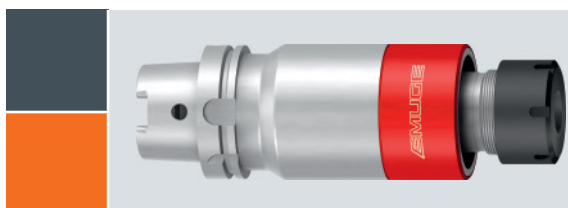

Zum Spannen von Gewindebohrern für die Herstellung großer Gewinde empfehlen wir die Verwendung von Aufnahmen der Typenreihen Softsynchro® und HF. Diese finden Sie auf den Seiten 664 - 665, 675 - 676 und 747 - 754.

For the clamping of taps for the production of large threads, we recommend using our holders of the Softsynchro® and HF series. You will find these on pages 664 - 665, 675 - 676 and 747 - 754.

M



DIN 13

Mit langen Nuten und langem Schaft für Gewindetiefen bis max. 4 x d₁
With long flutes and long shank for thread depths up to max. 4 x d₁

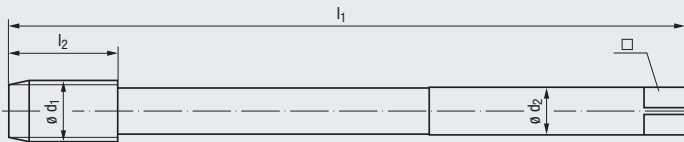

Technische Informationen
Technical information

» 245 - 266

Toleranz · Tolerance
Beschichtung · Coating
Schneidstoff · Cutting material



Gewindetiefe und Lochform
Thread depth and hole type

Einsatzgebiete – Material
Applications – material

» 22

Werkzeug-Ident · Tool ident

M	Ø d ₁ mm	P mm	l ₁	l ₂	Ø d ₂	□	Ø	Dimens.- Ident	Z CNC-controlled machines		
									C0539401 Rekord 2A-Z-1KZ-LF4 TICN	C4283701 Rekord 2D-Z-1KZ-LF4 TIN	C4063701 Rekord 2D-Z-BF-1KZ-LF4 TIN
	20	2,5	190	25	16	12	17,5	.0120	●	●	○
	22	2,5	230	27	18	14,5	19,5	.0122	●	●	○
	24	3	240	30	18	14,5	21	.0124	●	●	○
	27	3	250	30	20	16	24	.0127	●	●	○
	30	3,5	270	35	22	18	26,5	.0130	●	●	○
	33	3,5	290	35	25	20	29,5	.0133	●	●	○
	36	4	310	40	28	22	32	.0136	●	●	○
	42	4,5	340	45	32	24	37,5	.0142	●	●	○
	45	4,5	360	45	36	29	40,5	.0145	●	●	○

1) Gewindebohren in Durchgangslöchern nur mit externer Kühlschmierung möglich
Threading in through holes is possible only with external cooling/lubrication

- Product Finder
- V_c
- M
- MF
- UNC UN-8
- UNF UNEF
- G, Rp NPSM, NPSF
- NPT, NPTF Rc, W
- BSW, BSF
- Pg
- MJ UNJC, UNJF
- EG (ST) SELF-LOCK
- Tr, Tr-F Rd
- Zubehör Accessories
- Tech. Info



- Product Finder
- V_c
- M
- MF
- UNC UN-8
- UNF UNEF
- G, Rp NPSM, NPSF
- NPT, NPTF Rc, W
- BSW, BSF
- Pg
- MJ UNJC, UNJF
- EG (STI) SELF-LOCK
- Tr, Tr-F Rd
- Zubehör Accessories
- Tech. Info

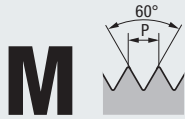

DIN 13

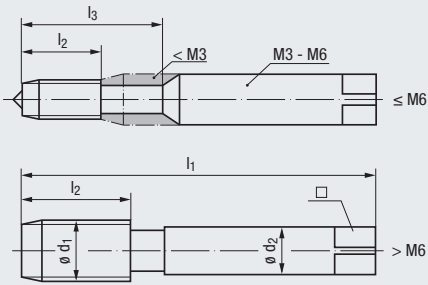

DIN 352

STEEL
Steel materials



Toleranz · Tolerance
Beschichtung · Coating
Schneidstoff · Cutting material

Technische Informationen
Technical information

» 245 - 266



6HX	6HX	6HX	ISO 2/6H	ISO 2/6H
HSSE	HSSE	HSSE	HSSE	HSSE
	LH			
C / 2-3	C / 2-3	C / 2-3	B / 4-5	B / 4-5
E / 0	E / 0	E / 0	E / 0	E / 0

Gewindetiefe und Lochform
Thread depth and hole type



Einsatzgebiete – Material
Applications – material

» 22

P 1.1-3.1 N 2.3	P 1.1-3.1 N 2.3	P 1.1-3.1 N 2.3	P 2.1-4.1	P 2.1-4.1
--------------------	--------------------	--------------------	-----------	-----------

Werkzeug-Ident · Tool ident

M	ϕd_1 mm	P mm	l ₁	l ₂	l ₃	ϕd_2	\square	Dimens.- Ident	Rekord A-STEEL	Rekord A-STEEL-LH	Rekord A-STEEL-AZ	Rekord B-STEEL-M	Rekord B-STEEL-M AZ
									A0101001	A0101051	A0121001	A0201000	A0221000
1	1	0,25	32	5	–	2,5	2,1	0,75	○ ^{*)}				
1,1	1,1	0,25	32	5	–	2,5	2,1	0,85	.0011				
1,2	1,2	0,25	32	5	–	2,5	2,1	0,95	.0012	○ ^{*)}			
1,4	1,4	0,3	32	7	–	2,5	2,1	1,1	.0014	○ ^{*)}			
1,6	1,6	0,35	32	8	–	2,5	2,1	1,25	.0016	○			
1,8	1,8	0,35	32	8	–	2,5	2,1	1,45	.0018	○			
2	2	0,4	36	8	–	2,8	2,1	1,6	.0020	○			
2,2	2,2	0,45	36	9	–	2,8	2,1	1,75	.0022	○			
2,3	2,3	0,4	36	9	–	2,8	2,1	1,9	.0023	○			
2,5	2,5	0,45	40	9	–	2,8	2,1	2,05	.0025	○			
2,6	2,6	0,45	40	9	–	2,8	2,1	2,15	.0026	○			
3	3	0,5	40	10	18	3,5	2,7	2,5	.0030	●	●	○	○
3,5	3,5	0,6	45	11	20	4	3	2,9	.0035	○	○	○	○
4	4	0,7	45	12	22	4,5	3,4	3,3	.0040	●	●	○	○
4,5	4,5	0,75	50	13	24	6	4,9	3,7	.0045				
5	5	0,8	50	14	25	6	4,9	4,2	.0050	●	●	○	○
6	6	1	56	16	28	6	4,9	5	.0060	●	●	○	○
7	7	1	56	18	–	6	4,9	6	.0070				
8	8	1,25	63	20	–	6	4,9	6,8	.0080	●	●	○	○
9	9	1,25	63	20	–	7	5,5	7,8	.0090				
10	10	1,5	70	22	–	7	5,5	8,5	.0100	●	●	○	○
11	11	1,5	70	22	–	8	6,2	9,5	.0111				
12	12	1,75	75	24	–	9	7	10,2	.0112	●	●	○	○
14	14	2	80	26	–	11	9	12	.0114	○	○		
16	16	2	80	27	–	12	9	14	.0116	○	○		
18	18	2,5	95	30	–	14	11	15,5	.0118	○	○		
20	20	2,5	95	32	–	16	12	17,5	.0120	○	○		
22	22	2,5	100	32	–	18	14,5	19,5	.0122	○	○		
24	24	3	110	34	–	18	14,5	21	.0124	○	○		
27	27	3	110	36	–	20	16	24	.0127	○			
30	30	3,5	125	40	–	22	18	26,5	.0130	○			



DIN 371	36		36	37
DIN 376	64		64	65

^{*)} ≤ M1,4 Tol. 4H(X)/5H(X)



STEEL Steel materials		VA Stainless steel materials	MS Copper-zinc alloys		Z CNC-controlled machines
ISO 2/6H	ISO 2/6H	ISO 2/6H	6HX	6GX	ISO 2/6H
HSSE	HSSE	NT	HSSE	HSSE	HSSE
R15	R35	HSSE	C / 2-3	C / 2-3	R45
C / 2-3	C / 2-3	B / 4-5	E	E	E / 1,5-2
E / O	E / O	E / O / P			E / O / P
max. 2 x d ₁	max. 2,5 x d ₁	max. 3 x d ₁	max. 2 x d ₁		max. 3 x d ₁
P 2.1-3.1	P 1.1-3.1	P 1.1-3.1	N 2.3	N 2.3	P 1.1-4.1
	N 2.2	M 1.1-2.1			M 1.1-2.1
		K 2.1			N 2.1
		N 2.2, 2.5-6			
A0451000	A0501000	A0203000	A0102501	A0102521	A0513500
Rekord D-STEEL	Enorm STEEL	Rekord B-VA NT	Rekord A-MS	Rekord A-MS „6GX“	Enorm Z/E
			○		
			○		
			○		
			○		
●	●	●	●	●	○
			○	○	
●	●	●	●	●	○
●	●	●	●	●	○
●	●	●	●	●	○
●	●	●	●	●	○
	○				
	○				
📄 39	📄 39	📄 41	📄 48		📄 59
📄 66	📄 66	📄 68			📄 81

M
1
1,1
1,2
1,4
1,6
1,8
2
2,2
2,3
2,5
2,6
3
3,5
4
4,5
5
6
7
8
9
10
11
12
14
16
18
20
22
24
27
30

● = Lagerwerkzeug, siehe Preisliste · Stock tool, see price list
 ○ = Kurzfristig lieferbar, Preis auf Anfrage · Available on short notice, price upon inquiry

- Product Finder
- V_c
- M
- MF
- UNC UN-8
- UNF UNEF
- G, Rp NPSM, NPSF
- NPT, NPTF Rc, W
- BSW, BSF
- Pg
- MJ UNJC, UNJF
- EG (STI) SELF-LOCK
- Tr, Tr-F Rd
- Zubehör Accessories
- Tech. Info

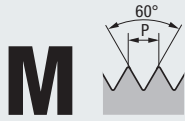

DIN 13

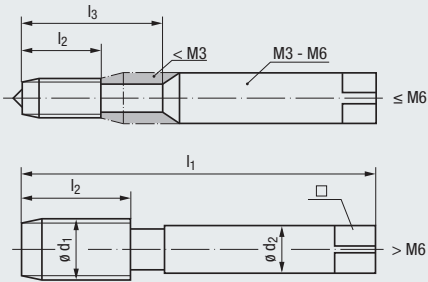

DIN 352



Technische Informationen Technical information	Toleranz · Tolerance Beschichtung · Coating Schneidstoff · Cutting material	HSSE	HSSE	HSSE	HSSE
		A / 5-6 O / P	D / 3-4 O / P	C / 2-3 O / P	C / 2-3 O / P
Gewindetiefe und Lochform Thread depth and hole type	max. 2 x d ₁				

Einsatzgebiete – Material
Applications – material

P 1.1-3.1

Werkzeug-Ident · Tool ident

H0111019 H0111029 H0111001 H0101001

M	Ø d ₁ mm	P mm	l ₁	l ₂	l ₃	Ø d ₂	□	Dimens.- Ident	HGB-Set V-Nr.1	HGB-Set M-Nr.2	HGB-Set F	HGB-Set 3S (Nr.1, Nr.2, F)
									•	•	• ^{*)}	• ^{*)}
1	0,25	32	5	–	2,5	2,1	0,75	.0010	•	•	• ^{*)}	• ^{*)}
1,1	0,25	32	5	–	2,5	2,1	0,85	.0011				
1,2	0,25	32	5	–	2,5	2,1	0,95	.0012				
1,4	0,3	32	7	–	2,5	2,1	1,1	.0014	•	•	• ^{*)}	• ^{*)}
1,6	0,35	32	8	–	2,5	2,1	1,25	.0016	•	•	•	•
1,7	0,35	32	8	–	2,5	2,1	1,35	.0017				
1,8	0,35	32	8	–	2,5	2,1	1,45	.0018				
2	0,4	36	8	–	2,8	2,1	1,6	.0020	•	•	•	•
2,2	0,45	36	9	–	2,8	2,1	1,75	.0022				
2,3	0,4	36	9	–	2,8	2,1	1,9	.0023				
2,5	0,45	40	9	–	2,8	2,1	2,05	.0025	•	•	•	•
2,6	0,45	40	9	–	2,8	2,1	2,15	.0026				
3	0,5	40	10	18	3,5	2,7	2,5	.0030	•	•	•	•
3,5	0,6	45	11	20	4	3	2,9	.0035	•	•	•	•
4	0,7	45	12	22	4,5	3,4	3,3	.0040	•	•	•	•
4,5	0,75	50	13	24	6	4,9	3,7	.0045				
5	0,8	50	14	25	6	4,9	4,2	.0050	•	•	•	•
6	1	56	16	28	6	4,9	5	.0060	•	•	•	•
7	1	56	18	–	6	4,9	6	.0070	•	•	•	•
8	1,25	63	20	–	6	4,9	6,8	.0080	•	•	•	•
9	1,25	63	20	–	7	5,5	7,8	.0090				
10	1,5	70	22	–	7	5,5	8,5	.0100	•	•	•	•
11	1,5	70	22	–	8	6,2	9,5	.0111	•	•	•	•
12	1,75	75	24	–	9	7	10,2	.0112	•	•	•	•
14	2	80	26	–	11	9	12	.0114	•	•	•	•
16	2	80	27	–	12	9	14	.0116	•	•	•	•
18	2,5	95	30	–	14	11	15,5	.0118				
20	2,5	95	32	–	16	12	17,5	.0120	•	•	•	•
22	2,5	100	32	–	18	14,5	19,5	.0122				
24	3	110	34	–	18	14,5	21	.0124	•	•	•	•
27	3	110	36	–	20	16	24	.0127	•	•	•	•
30	3,5	125	40	–	22	18	26,5	.0130	•	•	•	•
33	3,5	125	40	–	25	20	29,5	.0133	•	•	•	•
36	4	150	50	–	28	22	32	.0136	•	•	•	•

^{*)} ≤ M1,4 Tol. 4HX/5HX

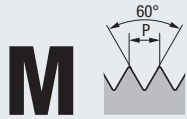

DIN 13

≈ DIN 352

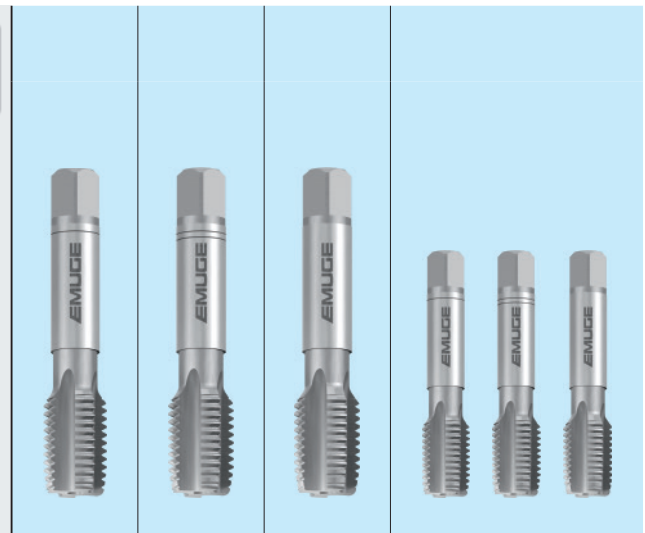
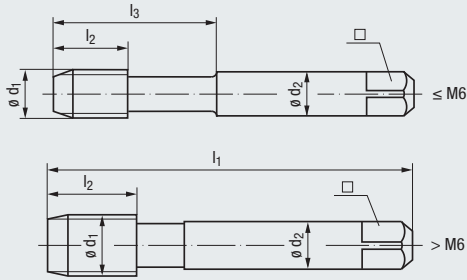

- Product Finder
- Vc
- M
- MF
- UNC UN-8
- UNF UNEF
- G, Rp NPSM, NPSF
- NPT, NPTF Rc, W
- BSW, BSF
- Pg
- MJ UNJC, UNJF
- EG (STI) SELF-LOCK
- Tr, Tr-F Rd
- Zubehör Accessories
- Tech. Info

Toleranz · Tolerance
Beschichtung · Coating
Schneidstoff · Cutting material

Technische Informationen
Technical information

» 245 - 266

		6HX	6HX
VHM/KHM	VHM/KHM	VHM/KHM	VHM/KHM
C / ≈3	C / ≈3	C / ≈3	C / ≈3
O / P	O / P	O / P	O / P

Gewindetiefe und Lochform
Thread depth and hole type

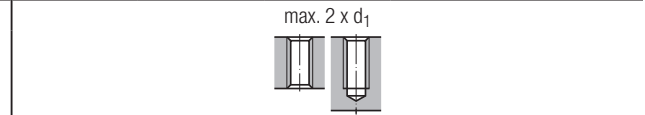

Einsatzgebiete – Material
Applications – material

» 22

P 5.1	P 5.1	P 5.1	P 5.1
N 2.8.5.2	N 2.8.5.2	N 2.8.5.2	N 2.8.5.2
H 1.1-3	H 1.1-3	H 1.1-3	H 1.1-3

Werkzeug-Ident · Tool ident

M	ø d1 mm	P mm	l1	l2	max. l3	ø d2	□	Dimens.- Ident	H0310919	H0310929	H0310901	H0300901
									VHM/KHM Set V-Nr.1	VHM/KHM Set M-Nr.2	VHM/KHM Set F	VHM/KHM Set 3S (Nr.1, Nr.2, F)
	3	0,5	40	6	18	3,5	2,7	2,5	●	●	●	●
	4	0,7	45	7	19	4,5	3,4	3,3	●	●	●	●
	5	0,8	50	9	25	6	4,9	4,2	●	●	●	●
	6	1	56	10	26	6	4,9	5	●	●	●	●
	8	1,25	63	14	—	6	4,9	6,8	●	●	●	●
	10	1,5	70	16	—	7	5,5	8,5	●	●	●	●
	12	1,75	75	18	—	9	7	10,2	●	●	●	●
	14	2	80	20	—	11	9	12	●	●	●	●
	16	2	80	22	—	12	9	14	●	●	●	●
	20	2,5	95	25	—	16	12	17,5	●	●	●	●



Kühlschmierstoffe siehe Seite 238 - 239

Coolant-lubricants, see page 238 - 239

- Product Finder
- V_c
- M
- MF
- UNC UN-8
- UNF UNEF
- G, Rp NPSM, NPSF
- NPT, NPTF Rc, W
- BSW, BSF
- Pg
- MJ UNJC, UNJF
- EG (STI) SELF-LOCK
- Tr, Tr-F Rd
- Zubehör Accessories
- Tech. Info

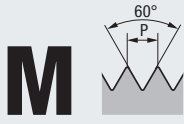

DIN 352

DIN 13

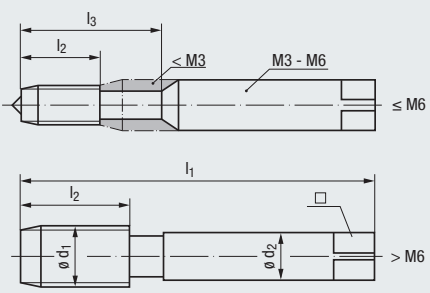

Toleranz · Tolerance
 Beschichtung · Coating
 Schneidstoff · Cutting material

Technische Informationen
 Technical information

Technical information icon: 245 - 266

HSSE	HSSE	HSSE	6HX HSSE
C / 2-3	C / 2-3	C / 2-3	C / 2-3
O / P	O / P	O / P	O / P

Gewindetiefe und Lochform
 Thread depth and hole type

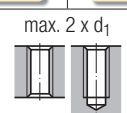

Einsatzgebiete – Material
 Applications – material

Technical information icon: 22

P 1.1-5.1	P 1.1-5.1	P 1.1-5.1	P 1.1-5.1
M 1.1-4.1	M 1.1-4.1	M 1.1-4.1	M 1.1-4.1
S 2.1-2, 2.4	S 2.1-2, 2.4	S 2.1-2, 2.4	S 2.1-2, 2.4

Werkzeug-Ident · Tool ident

H0413019 H0423019 H0423029 H0423001

M	Ø d ₁ mm	P mm	l ₁	l ₂	l ₃	Ø d ₂	□	Dimens.- Ident	WM-Set V-Nr.1Z	WM-Set V-Nr.1	WM-Set M-Nr.2	WM-Set F
	2	0,4	36	8	–	2,8	2,1	1,6	●	●	●	●
	2,2	0,45	36	9	–	2,8	2,1	1,75				
	2,3	0,4	36	9	–	2,8	2,1	1,9				
	2,5	0,45	40	9	–	2,8	2,1	2,05	●	●	●	●
	2,6	0,45	40	9	–	2,8	2,1	2,15				
	3	0,5	40	10	18	3,5	2,7	2,5	●	●	●	●
	3,5	0,6	45	11	20	4	3	2,9	●	●	●	●
	4	0,7	45	12	22	4,5	3,4	3,3	●	●	●	●
	5	0,8	50	14	25	6	4,9	4,2	●	●	●	●
	6	1	56	16	28	6	4,9	5	●	●	●	●
	8	1,25	63	20	–	6	4,9	6,8	●	●	●	●
	10	1,5	70	22	–	7	5,5	8,5	●	●	●	●
	12	1,75	75	24	–	9	7	10,2	●	●	●	●
	14	2	80	26	–	11	9	12	●	●	●	●
	16	2	80	27	–	12	9	14	●	●	●	●
	18	2,5	95	30	–	14	11	15,5				
	20	2,5	95	32	–	16	12	17,5	●	●	●	●
	22	2,5	100	32	–	18	14,5	19,5				
	24	3	110	34	–	18	14,5	21	●	●	●	●
	27	3	110	36	–	20	16	24				
	30	3,5	125	40	–	22	18	26,5				

1) Der Vorschneider Nr.1Z mit Führungszapfen ist eine zusätzliche Hilfe zum winkelrechten Anschneiden von Hand. Er kann z.B. auf der Maschine weggelassen werden. Die Profilabstufung von Nr.1Z und Nr.1 ist gleich. The taper tap No. 1Z with cylindrical pilot is an additional aid for true alignment especially when tapping by hand. It can be deleted when tapping by machine. The profile graduation of No.1Z, and No.1 is the same.

Product Finder

V_c

M

MF

UNC
UN-8

UNF
UNEF

G, Rp
NPSM, NPSF

NPT, NPTF
Rc, W

BSW, BSF

Pg

MJ
UNJC, UNJF

EG (STI)
SELF-LOCK

Tr, Tr-F
Rd

Zubehör
Accessories

Tech. Info

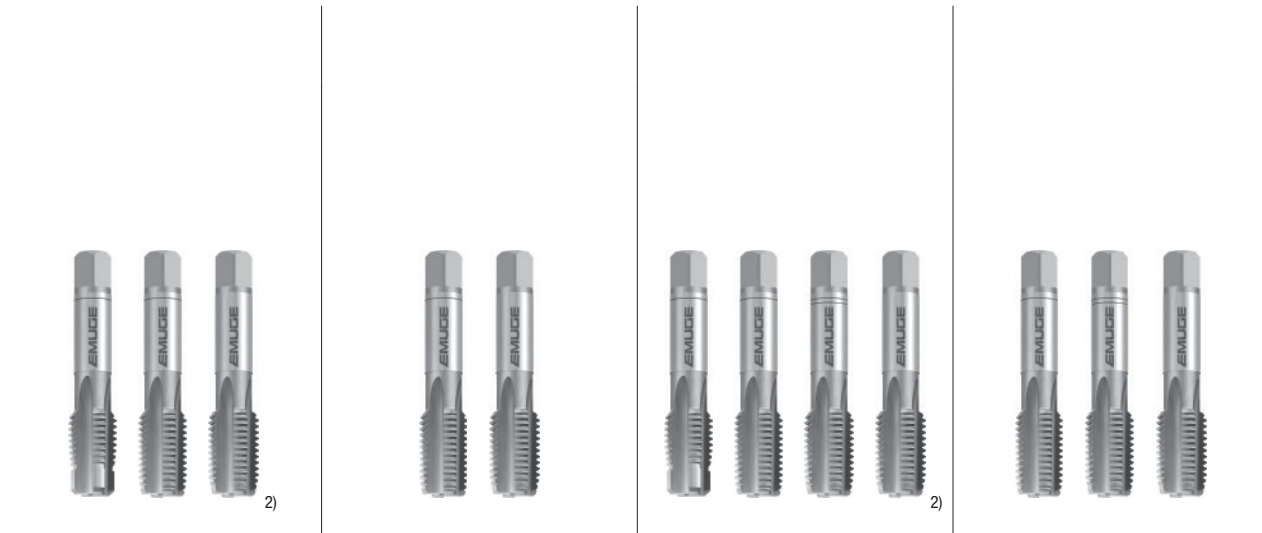
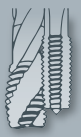

6HX	6HX	6HX	6HX
HSSE	HSSE	HSSE	HSSE
C / 2-3	C / 2-3	C / 2-3	C / 2-3
O / P	O / P	O / P	O / P

max. 2 x d₁

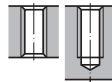

P 1.1-5.1	P 1.1-5.1	P 1.1-5.1	P 1.1-5.1
M 1.1-4.1	M 1.1-4.1	M 1.1-4.1	M 1.1-4.1
S 2.1-2, 2.4	S 2.1-2, 2.4	S 2.1-2, 2.4	S 2.1-2, 2.4

H0453001	H0483001	H0403001	H0433001
WM-Set 3S	WM-Set 2S	WM-Set 4S	WM-Set 3S
(Nr.1Z, Nr.1, F)	(Nr.1, F)	(Nr.1Z, Nr.1, Nr.2, F)	(Nr.1, Nr.2, F)

●	●	●	●	M 2
				2,2
				2,3
●	●	●	●	2,5
				2,6
●	●	●	●	3
●	●	●	●	3,5
●	●	●	●	4
●	●	●	●	5
●	●	●	●	6
●	●	●	●	8
●	●	●	●	10
●	●	●	●	12
●	●	●	●	14
●	●	●	●	16
●	●	●	●	18
●	●	●	●	20
●	●	●	●	22
●	●	●	●	24
				27
				30

2) Beim Gewindebohren von Hand in Durchgangslöcher entfällt Nr.1
No.1 is not needed when tapping in through holes by hand

- Product Finder
- V_c
- M
- MF
- UNC UN-8
- UNF UNEF
- G, Rp NPSM, NPSF
- NPT, NPTF Rc, W
- BSW, BSF
- Pg
- MJ UNJC, UNJF
- EG (STI) SELF-LOCK
- Tr, Tr-F Rd
- Zubehör Accessories
- Tech. Info

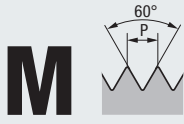

DIN 352

DIN 13

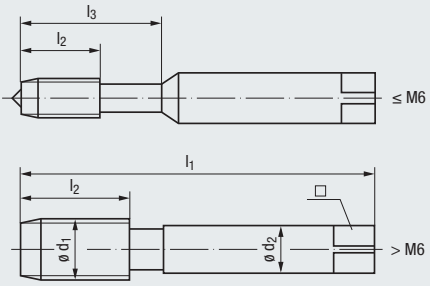

Toleranz · Tolerance
 Beschichtung · Coating
 Schneidstoff · Cutting material

Technische Informationen
 Technical information

Technical information icon: 245 - 266

Technical drawing icon: max. 2 x d₁

TIN	TIN	TIN	6HX
HSSE	HSSE	HSSE	TIN
C / 2-3	C / 2-3	C / 2-3	HSSE
O / P	O / P	O / P	C / 2-3
			O / P

Gewindetiefe und Lochform
 Thread depth and hole type

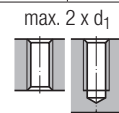

Einsatzgebiete – Material
 Applications – material

Technical drawing icon: 22

P 1.1-5.1	P 1.1-5.1	P 1.1-5.1	P 1.1-5.1
M 1.1-4.1	M 1.1-4.1	M 1.1-4.1	M 1.1-4.1
N 2.7	N 2.7	N 2.7	N 2.7
S 2.1-6	S 2.1-6	S 2.1-6	S 2.1-6

Werkzeug-Ident · Tool ident

M	∅ d ₁ mm	P mm	l ₁	l ₂	l ₃	∅ d ₂	□	Image	Dimens.- Ident	H0413119	H0423119	H0423129	H0423101
										WM-Set V-Nr.1Z TIN	WM-Set V-Nr.1 TIN	WM-Set M-Nr.2 TIN	WM-Set F TIN
	3	0,5	40	10	18	3,5	2,7	2,5	.0030	●	●	●	●
	4	0,7	45	12	22	4,5	3,4	3,3	.0040	●	●	●	●
	5	0,8	50	14	25	6	4,9	4,2	.0050	●	●	●	●
	6	1	56	16	28	6	4,9	5	.0060	●	●	●	●
	8	1,25	63	20	—	6	4,9	6,8	.0080	●	●	●	●
	10	1,5	70	22	—	7	5,5	8,5	.0100	●	●	●	●
	12	1,75	75	24	—	9	7	10,2	.0112	●	●	●	●
	14	2	80	26	—	11	9	12	.0114	●	●	●	●
	16	2	80	27	—	12	9	14	.0116	●	●	●	●

1) Der Vorschneider Nr.1Z mit Führungszapfen ist eine zusätzliche Hilfe zum winkelrechten Anschneiden von Hand. Er kann z.B. auf der Maschine weggelassen werden. Die Profilabstufung von Nr.1Z und Nr.1 ist gleich.
 The taper tap No. 1Z with cylindrical pilot is an additional aid for true alignment especially when tapping by hand. It can be deleted when tapping by machine. The profile graduation of No.1Z, and No.1 is the same.

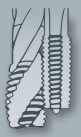

<ul style="list-style-type: none"> 6HX TIN HSSE C / 2-3 O / P 	<ul style="list-style-type: none"> 6HX TIN HSSE C / 2-3 O / P 	<ul style="list-style-type: none"> 6HX TIN HSSE C / 2-3 O / P 	<ul style="list-style-type: none"> 6HX TIN HSSE C / 2-3 O / P
--	--	--	--

max. 2 x d₁

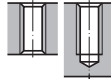

<ul style="list-style-type: none"> P 1.1-5.1 M 1.1-4.1 N 2.7 S 2.1-6 	<ul style="list-style-type: none"> P 1.1-5.1 M 1.1-4.1 N 2.7 S 2.1-6 	<ul style="list-style-type: none"> P 1.1-5.1 M 1.1-4.1 N 2.7 S 2.1-6 	<ul style="list-style-type: none"> P 1.1-5.1 M 1.1-4.1 N 2.7 S 2.1-6
--	--	--	--

H0453101	H0483101	H0403101	H0433101
WM-Set 3S TIN (Nr.1Z, Nr.1, F)	WM-Set 2S TIN (Nr.1, F)	WM-Set 4S TIN (Nr.1Z, Nr.1, Nr.2, F)	WM-Set 3S TIN (Nr.1, Nr.2, F)

●	●	●	●	M 3	
●	●	●	●		4
●	●	●	●		5
●	●	●	●		6
●	●	●	●		8
●	●	●	●		10
●	●	●	●		12
				14	
				16	

2) Beim Gewindebohren von Hand in Durchgangslöcher entfällt Nr.1
No.1 is not needed when tapping in through holes by hand



Verstellbare Windeisen siehe Seite 243

Adjustable tap wrenches, see page 243

- Product Finder
- V_c
- M
- MF
- UNC UN-8
- UNF UNEF
- G, Rp NPSM, NPSF
- NPT, NPTF Rc, W
- BSW, BSF
- Pg
- MJ UNJC, UNJF
- EG (STI) SELF-LOCK
- Tr, Tr-F Rd
- Zubehör Accessories
- Tech. Info

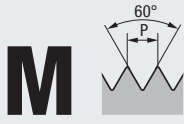

DIN 352

DIN 13

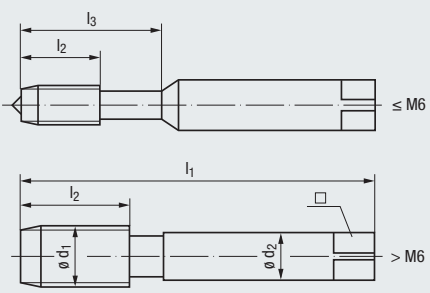

Toleranz · Tolerance
 Beschichtung · Coating
 Schneidstoff · Cutting material

Technische Informationen
 Technical information

Technical information icon: 245 - 266

NT	NT	NT	6HX
HSSE	HSSE	HSSE	NT
C / 2-3	C / 2-3	C / 2-3	HSSE
O / P	O / P	O / P	C / 2-3
			O / P

Gewindetiefe und Lochform
 Thread depth and hole type

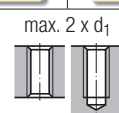

Einsatzgebiete – Material
 Applications – material



Technical information icon: 22

P 3.1-5.1	P 3.1-5.1	P 3.1-5.1	P 3.1-5.1
N 2.7	N 2.7	N 2.7	N 2.7
S 2.3, 2.5-6	S 2.3, 2.5-6	S 2.3, 2.5-6	S 2.3, 2.5-6

Werkzeug-Ident · Tool ident

Ø d ₁ mm	P mm	l ₁	l ₂	l ₃	Ø d ₂	□	Image	Dimens.- Ident	H0417119	H0427119	H0427129	H0427101
									WM-F-TIC-Set V-Nr.1Z NT	WM-F-TIC-Set V-Nr.1 NT	WM-F-TIC-Set M-Nr.2 NT	WM-F-TIC-Set F NT
M 3	0,5	40	10	18	3,5	2,7	2,5	.0030	●	●	●	●
4	0,7	45	12	22	4,5	3,4	3,3	.0040	●	●	●	●
5	0,8	50	14	25	6	4,9	4,2	.0050	●	●	●	●
6	1	56	16	28	6	4,9	5	.0060	●	●	●	●
8	1,25	63	20	—	6	4,9	6,8	.0080	●	●	●	●
10	1,5	70	22	—	7	5,5	8,5	.0100	●	●	●	●
12	1,75	75	24	—	9	7	10,2	.0112	●	●	●	●
16	2	80	27	—	12	9	14	.0116	●	●	●	●
20	2,5	95	32	—	16	12	17,5	.0120	●	●	●	●

1) Der Vorschneider Nr.1Z mit Führungszapfen ist eine zusätzliche Hilfe zum winkelrechten Anschneiden von Hand. Er kann z.B. auf der Maschine weggelassen werden. Die Profilabstufung von Nr.1Z und Nr.1 ist gleich.
 The taper tap No. 1Z with cylindrical pilot is an additional aid for true alignment especially when tapping by hand. It can be deleted when tapping by machine. The profile graduation of No.1Z, and No.1 is the same.

 <p>2)</p>				
<p>6HX NT HSSE</p> <p>C / 2-3 O / P</p>	<p>6HX NT HSSE</p> <p>C / 2-3 O / P</p>			
<p>max. 2 x d₁</p> 				
<p>P 3.1-5.1 N 2.7 S 2.3, 2.5-6</p>	<p>P 3.1-5.1 N 2.7 S 2.3, 2.5-6</p>			
<p>H0407101 WM-F-TIC-Set 4S NT (Nr.1Z, Nr.1, Nr.2, F)</p>	<p>H0437101 WM-F-TIC-Set 3S NT (Nr.1, Nr.2, F)</p>			
<p>● ● ● ● ● ● ● ● ●</p>	<p>● ● ● ● ● ● ● ● ●</p>			<p>M 3 4 5 6 8 10 12 16 20</p>

2) Beim Gewindebohren von Hand in Durchgangslöcher entfällt Nr.1
No.1 is not needed when tapping in through holes by hand

- Product Finder
- V_c
- M
- MF
- UNC UN-8
- UNF UNEF
- G, Rp NPSM, NPSF
- NPT, NPTF Rc, W
- BSW, BSF
- Pg
- MJ UNJC, UNJF
- EG (STI) SELF-LOCK
- Tr, Tr-F Rd
- Zubehör Accessories
- Tech. Info



- Product Finder
- V_c
- M
- MF
- UNC UN-8
- UNF UNEF
- G, Rp NPSM, NPSF
- NPT, NPTF Rc, W
- BSW, BSF
- Pg
- MJ UNJC, UNJF
- EG (STI) SELF-LOCK
- Tr, Tr-F Rd
- Zubehör Accessories
- Tech. Info

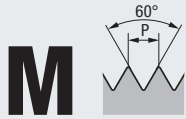

DIN 13

Normal lang und extra lang
Standard length and extra long

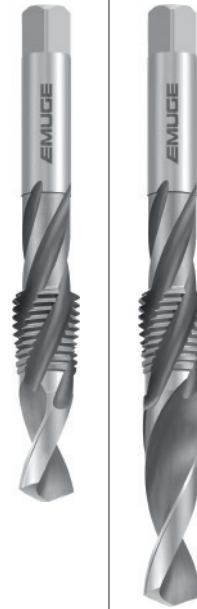
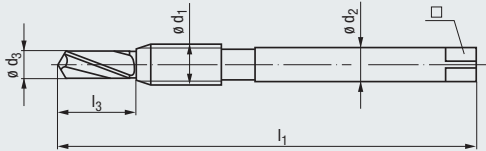

Toleranz · Tolerance
Beschichtung · Coating
Schneidstoff · Cutting material

Technische Informationen
Technical information

» 245 - 266

» 22

ISO 2/6H	ISO 2/6H
HSSE	HSSE
C / 2-3	C / 2-3
E / 0	E / 0

Gewindetiefe und Lochform
Thread depth and hole type



Einsatzgebiete – Material
Applications – material

P 1.1-2.1	P 1.1-2.1
N 2.2	N 2.2

Normal lang · Standard length

Werkzeug-Ident · Tool ident									M0601000			
$\varnothing d_1$ mm	P mm	l_1	l_3	$\varnothing d_2$	□	$\varnothing d_3$	Dimens.- Ident	KOMBI Normal-Ig				
M 3	0,5	62	9	3,5	2,7	2,55	.0030	○				
3,5	0,6	66	10	4	3	2,95	.0035					
4	0,7	66	10	4,5	3,4	3,36	.0040	○				
5	0,8	75	12	6	4,9	4,26	.0050	○				
6	1	81	14	6	4,9	5,05	.0060	○				
8	1,25	93	20	6	4,9	6,8	.0080	○				
10	1,5	99	22	7	5,5	8,55	.0100	○				
12	1,75	106	25	9	7	10,3	.0112	○				
14	2	114	28	11	9	12,1	.0114					
16	2	123	32	12	9	14,1	.0116	○				
18	2,5	132	36	14	11	15,6	.0118					
20	2,5	132	36	16	12	17,6	.0120	○				

Extra lang · Extra long

Werkzeug-Ident · Tool ident									M0621000			
$\varnothing d_1$ mm	P mm	l_1	l_3	$\varnothing d_2$	□	$\varnothing d_3$	Dimens.- Ident	KOMBI Extra-Ig				
M 3	0,5	71	18	3,5	2,7	2,55	.0030	○				
4	0,7	77	21	4,5	3,4	3,36	.0040	○				
5	0,8	87	24	6	4,9	4,26	.0050	○				
6	1	94	27	6	4,9	5,05	.0060	○				
8	1,25	109	36	6	4,9	6,8	.0080	○				
10	1,5	118	41	7	5,5	8,55	.0100	○				
12	1,75	127	46	9	7	10,3	.0112	○				

M



DIN 13

DIN
357



Haben Sie Bedarf an Automaten-Mutter-Gewindebohrern?
Bitte sprechen Sie uns an!

Do you need taper taps?
Please contact us!

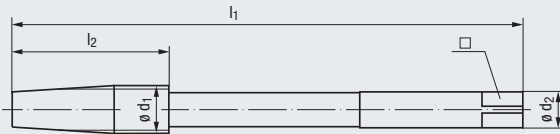

Technische Informationen
Technical information

» 245 - 266

Toleranz · Tolerance
Beschichtung · Coating
Schneidstoff · Cutting material



ISO 2/6H

HSSE

E / O

Gewindetiefe und Lochform
Thread depth and hole type

max. 1,5 x d₁



Einsatzgebiete – Material
Applications – material

» 22

P 1.1-2.1

N 2.2

Werkzeug-Ident · Tool ident

M0101000

M	Ø d ₁ mm	P mm	l ₁	l ₂	Ø d ₂	□	Ø	Dimens.- Ident	MMB DIN 357				
									○	○	○	○	
	3	0,5	70	16	2,2	–	2,5	.0030	○				
	4	0,7	90	22	2,8	2,1	3,3	.0040	○				
	5	0,8	100	24	3,5	2,7	4,2	.0050	○				
	6	1	110	30	4,5	3,4	5	.0060	○				
	7	1	110	30	5,5	4,3	6	.0070	○				
	8	1,25	125	38	6	4,9	6,8	.0080	○				
	10	1,5	140	45	7	5,5	8,5	.0100	○				
	12	1,75	180	50	9	7	10,2	.0112	○				
	14	2	200	56	11	9	12	.0114	○				
	16	2	200	63	12	9	14	.0116	○				
	18	2,5	220	63	14	11	15,5	.0118					
	20	2,5	250	70	16	12	17,5	.0120					
	22	2,5	280	80	18	14,5	19,5	.0122					
	24	3	280	80	18	14,5	21	.0124					
	27	3	315	90	20	16	24	.0127					
	30	3,5	315	100	22	18	26,5	.0130					

Product
Finder

V_c

M

MF

UNC
UN-8

UNF
UNEF

G, Rp
NPSM, NPSF

NPT, NPTF
Rc, W

BSW, BSF

Pg

MJ
UNJC, UNJF

EG (ST)
SELF-LOCK

Tr, Tr-F
Rd

Zubehör
Accessories

Tech. Info



- Product Finder
- Vc
- M
- MF**
- UNC UN-8
- UNF UNEF
- G, Rp NPSM, NPSF
- NPT, NPTF Rc, W
- BSW, BSF
- Pg
- MJ UNJC, UNJF
- EG (STI) SELF-LOCK
- Tr, Tr-F Rd
- Zubehör Accessories
- Tech. Info



DIN 13

DIN 371

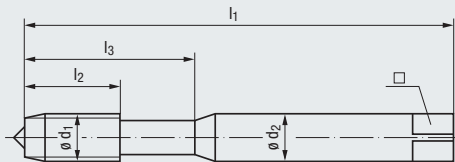

STEEL
Steel materials

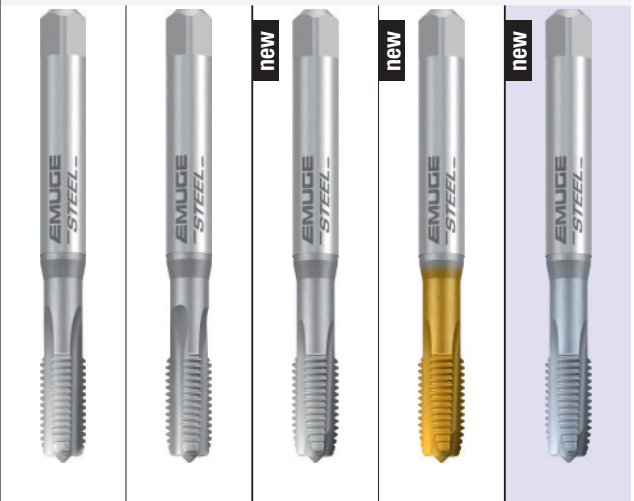

Toleranz · Tolerance
Beschichtung · Coating
Schneidstoff · Cutting material

6HX	6HX	ISO 2/6H	ISO 2/6H	6HX
HSSE	HSSE	HSSE	TIN	CRT
	LH			HSSE-PM
C / 2-3	C / 2-3	B / 4-5	B / 4-5	B / ≈6
E / O	E / O	E / O	E / O	E / O

Technische Informationen
Technical information

» 245 - 266



Gewindetiefe und Lochform
Thread depth and hole type



Einsatzgebiete – Material
Applications – material

» 22

P 1.1-3.1 N 2.3	P 1.1-3.1 N 2.3	P 1.1-3.1 N 2.2	P 1.1-4.1 K 2.1 N 2.2, 2.4-5	P 3.1-5.1
--------------------	--------------------	--------------------	------------------------------------	-----------

Werkzeug-Ident · Tool ident

B0101001 B0101051 B0208900 B0208400 B0208E01





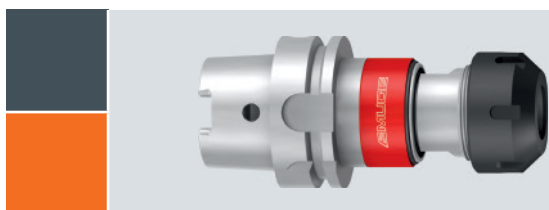





M	ø d ₁ mm	P mm	l ₁	l ₂	l ₃	ø d ₂	□	Dimens.- Ident	Rekord	Rekord	Rekord	Rekord	Rekord
									1A-STEEL	1A-STEEL-LH	1B-STEEL-L	1B-STEEL-L TIN	1B-STEEL-H PM-CRT
	2,5	x 0,35	50	7	12	2,8	2,1	.0196	○				
	2,6	x 0,35	50	7	12	2,8	2,1	.0199	○				
	3	x 0,35	56	8	18	3,5	2,7	.0202	○	○			
	3,5	x 0,35	56	9	20	4	3	.0205	○		●	○	
	4	x 0,5	63	10	21	4,5	3,4	.0210	●	●	●	●	
	5	x 0,5	70	11	25	6	4,9	.0218	●	●	●	●	
	6	x 0,5	80	13	30	6	4,9	.0228	●	●	●	●	
	6	x 0,75	80	13	30	6	4,9	.0229	●	●	●	●	
	7	x 0,75	80	13	30	7	5,5	.0239	○		●	○	
	8	x 0,75	80	14	30	8	6,2	.0250	●		●	●	
	8	x 1	90	17	35	8	6,2	.0251	●	●	●	●	●
	9	x 0,75	90	14	35	9	7	.0262	○		●	○	
	9	x 1	90	17	35	9	7	.0263	○		●	○	●
	10	x 0,75	90	15	35	10	8	.0275	○		●	●	
	10	x 1	90	18	35	10	8	.0276	●	●	●	●	●
	10	x 1,25	100	18	39	10	8	.0277	○		●	●	

DIN 374		108		108	108	111
DIN 2181		130	130			



Werkzeug-Aufnahmen der Typenreihe
Softsynchro® siehe Seite 661 - 681

Tool holders of our Softsynchro® series,
see page 661 - 681

STEEL Steel materials			VA Stainless steel materials						
									
ISO 2/6H	ISO 2/6H TIN	ISO 1/4H	ISO 2/6H TIN	ISO 2/6H GLT-1	ISO 2/6H	ISO 2/6H GLT-1			
HSSE	HSSE	HSSE	HSSE	HSSE	HSSE	HSSE			
R35	R35	R35			R35	R35			
C / 2-3	C / 2-3	C / 2-3	B / 4-5	B / 4-5	C / 2-3	C / 2-3			
E / 0	E / 0	E / 0	E / 0 / P	E / 0 / P	E / 0 / P	E / 0 / P			
max. 2,5 x d ₁ 			max. 3 x d ₁ 		max. 2,5 x d ₁ 				
P 1.1-3.1 N 2.2	P 1.1-4.1 K 2.1 N 2.2	P 1.1-3.1 N 2.2	P 1.1-4.1 M 1.1-3.1 K 2.1 N 2.2, 2.5-6	P 1.1-4.1 M 1.1-3.1 K 2.1 N 2.2	P 1.1-3.1 M 1.1-2.1 K 2.1	P 1.1-4.1 M 1.1-3.1 K 2.1			
B0501000	B0501400	B0501010	B0203100	B020C300	B0503000	B050C300			
Enorm 1-STEEL	Enorm 1-STEEL TIN	Enorm 1-STEEL „4H“	Rekord 1B-VA TIN	Rekord 1B-VA GLT-1	Enorm 1-VA	Enorm 1-VA GLT-1			
●								M 2,5 x 0,35	
○								2,6 x 0,35	
●								3 x 0,35	
●								3,5 x 0,35	
●	●	●	○	○	●	●		4 x 0,5	
●	●	○	○	○	●	●		5 x 0,5	
●	●	●			●	●		6 x 0,5	
●	●	●			○	●		6 x 0,75	
●					○			7 x 0,75	
●	●				○			8 x 0,75	
●					○			8 x 1	
●					○			9 x 0,75	
●					○			9 x 1	
●	●				●			10 x 0,75	
●	●				●			10 x 1	
●	●				●			10 x 1,25	
📄 113	📄 113	📄 113	📄 115	📄 115	📄 116	📄 117			

- Product Finder
- Vc
- M
- MF
- UNC UN-8
- UNF UNEF
- G, Rp NPSM, NPSF
- NPT, NPTF Rc, W
- BSW, BSF
- Pg
- MJ UNJC, UNJF
- EG (STI) SELF-LOCK
- Tr, Tr-F Rd
- Zubehör Accessories
- Tech. Info



● = Lagerwerkzeug, siehe Preisliste · Stock tool, see price list
○ = Kurzfristig lieferbar, Preis auf Anfrage · Available on short notice, price upon inquiry

- Product Finder
- Vc
- M
- MF**
- UNC UN-8
- UNF UNEF
- G, Rp NPSM, NPSF
- NPT, NPTF Rc, W
- BSW, BSF
- Pg
- MJ UNJC, UNJF
- EG (STI) SELF-LOCK
- Tr, Tr-F Rd
- Zubehör Accessories
- Tech. Info



DIN 13

DIN 371

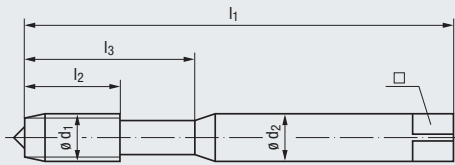

H
Materials of high tensile strength



HCUT
Hardened steels



Toleranz · Tolerance
Beschichtung · Coating
Schneidstoff · Cutting material

» 245 - 266

Technische Informationen
Technical information



6HX	6HX	6HX
NT		TICN
HSSE	VHM	HSSE-PM
C / 2-3	C / 2-3	C / 2-3
E / O / P	E / O	O / P

Gewindetiefe und Lochform
Thread depth and hole type

max. 2 x d ₁	max. 2 x d ₁	max. 1,5 x d ₁

Einsatzgebiete – Material
Applications – material

» 22

P 1.1-3.1	P 5.1	H 1.1-2
K 1.1-4.2	K 1.1-4.2	
N 2.4-7	N 1.5-6, 2.6-8	
N 4.1, 5.1	N 4.1, 4.3-5.2	
	H 1.1-2	

Werkzeug-Ident · Tool ident

B0100501 B1950901 B010J901

M	ø d ₁ mm	P mm	l ₁	l ₂	l ₃	ø d ₂	□	Dimens.- Ident	Rekord	VHM	Rekord
									1A-H NT	Rekord 1A-H- IKZ	1A-HCUT- PM TICN
	2,5	x 0,35	50	7	12	2,8	2,1	2,15	●		
	2,6	x 0,35	50	7	12	2,8	2,1	2,25	○		
	3	x 0,35	56	8	18	3,5	2,7	2,65	●		
	3,5	x 0,35	56	9	20	4	3	3,15	●		
	4	x 0,5	63	10	21	4,5	3,4	3,5	●		
	5	x 0,5	70	11	25	6	4,9	4,5	●		
	6	x 0,5	80	13	30	6	4,9	5,5	●		
	6	x 0,75	80	13	30	6	4,9	5,2	●	●	
	7	x 0,75	80	13	30	7	5,5	6,2	●		
	8	x 0,75	80	14	30	8	6,2	7,2	●		
	8	x 1	90	17	35	8	6,2	7 ²⁾	●	●	●
	9	x 0,75	90	14	35	9	7	8,2	●		
	9	x 1	90	17	35	9	7	8	●		
	10	x 0,75	90	15	35	10	8	9,2	●		
	10	x 1	90	18	35	10	8	9 ²⁾	●	●	●
	10	x 1,25	100	18	39	10	8	8,8	●	●	

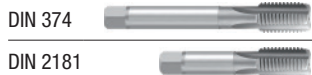

» 118 » 119 » 119

1) Gewindebohren in Durchgangslöcher nur mit externer Kühlschmierung möglich
Threading in through holes is possible only with external cooling/lubrication

2) Vorbohrdurchmesser für Gewindebohrer Rekord 1A-HCUT-PM-TICN um 0,1 mm anheben
Increase drill diameter for taps Rekord 1A-HCUT-PM-TICN by 0.1 mm

MF



DIN 13

DIN 371

HCUT
Hardened steels

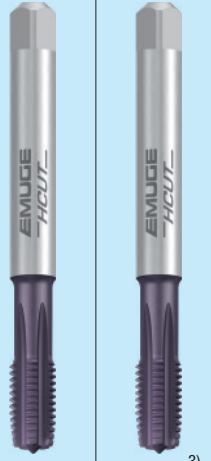

3)

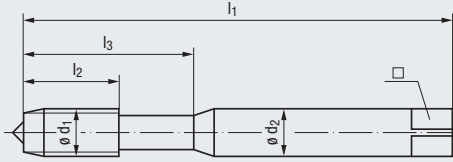

Technische Informationen
Technical information

» 245 - 266

Toleranz · Tolerance
Beschichtung · Coating
Schneidstoff · Cutting material



6HX	6HX
TICN	TICN
VHM	VHM
D / 4-5	C / 2-3
O / P	O / P

Gewindetiefe und Lochform
Thread depth and hole type

max. 1,5 x d ₁	max. 1,5 x d ₁

Einsatzgebiete – Material
Applications – material

» 22

H 1.3-4	H 1.3-4
---------	---------

Werkzeug-Ident · Tool ident

B016K101	B010K101
----------	----------

M	ø d ₁ mm	P mm	l ₁	l ₂	l ₃	ø d ₂	□		Dimens.- Ident	VHM Rekord 1A-HCUT/D TICN	VHM Rekord 1A-HCUT/C TICN
										●	●
	8	x 1	90	15	35	8	6,2	7,1	.0251	●	●
	10	x 1	100	18	38	10	8	9,1	.0276	●	●
	12	x 1,5	110	21	41	12	9	10,6	.0303	●	●
	14	x 1,5	110	24	44	14	11	12,6	.0331	●	●
	16	x 1,5	110	24	44	16	12	14,6	.0359	●	●

3) Achtung: VHM-Rekord 1A-HCUT/D-TICN als Vorschneider verwenden!
Please note: Use solid carbide tap VHM-Rekord 1A-HCUT/D-TICN as No.1 tap!

- Product Finder
- V_c
- M
- MF**
- UNC
UN-8
- UNF
UNEF
- G, Rp
NPSM, NPSF
- NPT, NPTF
Rc, W
- BSW, BSF
- Pg
- MJ
UNJC, UNJF
- EG (STI)
SELF-LOCK
- Tr, Tr-F
Rd
- Zubehör
Accessories
- Tech. Info



Spiralbohrer Typ EF-Drill-HCUT
siehe Seite 558

Twist drills type EF-Drill-HCUT,
see page 558

- Product Finder
- V_c
- M
- MF**
- UNC UN-8
- UNF UNEF
- G, Rp NPSM, NPSF
- NPT, NPTF Rc, W
- BSW, BSF
- Pg
- MJ UNJC, UNJF
- EG (STI) SELF-LOCK
- Tr, Tr-F Rd
- Zubehör Accessories
- Tech. Info



DIN 13

DIN 371

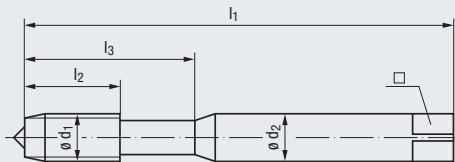

Z
CNC-controlled machines



Toleranz · Tolerance
Beschichtung · Coating
Schneidstoff · Cutting material

6HX	6HX
TIN-70	GLT-1
HSSE-PM	HSSE-PM
B / 4-5	B / 4-5
E / O / P	E / O / P

Technische Informationen
Technical information

» 245 - 266



Gewindetiefe und Lochform
Thread depth and hole type

max. 3 x d₁



Einsatzgebiete – Material
Applications – material

» 22

P 1.1-5.1	P 1.1-5.1
M 1.1-3.1	M 1.1-3.1
K 2.1	K 2.1
N 1.4-2.2, 2.4-5	N 1.4-2.2, 2.4-5
S 1.1	S 1.1

Werkzeug-Ident · Tool ident

B0208F01 B020A601

M	ø d ₁ mm	P mm	l ₁	l ₂	l ₃	ø d ₂	□	Ø	Dimens.- Ident	Rekord 1B-Z-PM TIN-70	Rekord 1B-Z-PM GLT-1
	2,5	x 0,35	50	5	12	2,8	2,1	2,15	.0196		
	2,6	x 0,35	50	5	12	2,8	2,1	2,25	.0199		
	3	x 0,35	56	4,5	18	3,5	2,7	2,65	.0202		
	3,5	x 0,35	56	5	20	4	3	3,15	.0205		
	4	x 0,5	63	5	21	4,5	3,4	3,5	.0210	•	•
	5	x 0,5	70	5	25	6	4,9	4,5	.0218	•	•
	6	x 0,5	80	5	30	6	4,9	5,5	.0228		
	6	x 0,75	80	8	30	6	4,9	5,2	.0229		
	7	x 0,75	80	10	30	7	5,5	6,2	.0239		
	8	x 0,75	80	8	30	8	6,2	7,2	.0250		
	8	x 1	90	10	35	8	6,2	7	.0251		
	9	x 0,75	90	10	35	9	7	8,2	.0262		
	9	x 1	90	10	35	9	7	8	.0263		
	10	x 0,75	90	10	35	10	8	9,2	.0275		
	10	x 1	90	10	35	10	8	9	.0276		
	10	x 1,25	100	16	39	10	8	8,8	.0277		

DIN 374

» 121

» 121

DIN 2181

MF



DIN 13

DIN 371

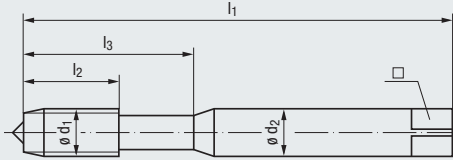

Technische Informationen
Technical information

» 245 - 266

Toleranz · Tolerance
Beschichtung · Coating
Schneidstoff · Cutting material



Gewindetiefe und Lochform
Thread depth and hole type

Einsatzgebiete – Material
Applications – material

» 22

Werkzeug-Ident · Tool ident

	Ø d ₁ mm	P mm	l ₁	l ₂	l ₃	Ø d ₂	□		Dimens.- Ident	max. 3 x d ₁			
										Enorm 1-Z/E	Enorm 1-Z/E TIN	Enorm 1-Z/E „6G“	Enorm 1-Z/E TIN „6G“
M	2,5	x 0,35	50	5	12	2,8	2,1	2,15	.0196				
	2,6	x 0,35	50	5	12	2,8	2,1	2,25	.0199				
	3	x 0,35	56	4,5	18	3,5	2,7	2,65	.0202				
	3,5	x 0,35	56	5	20	4	3	3,15	.0205				
	4	x 0,5	63	5	21	4,5	3,4	3,5	.0210	●	●	●	●
	5	x 0,5	70	5	25	6	4,9	4,5	.0218	●	●	●	●
	6	x 0,5	80	5	30	6	4,9	5,5	.0228	●	●	●	●
	6	x 0,75	80	8	30	6	4,9	5,2	.0229	●	●	●	●
	7	x 0,75	80	10	30	7	5,5	6,2	.0239				
	8	x 0,75	80	8	30	8	6,2	7,2	.0250				
	8	x 1	90	10	35	8	6,2	7	.0251				
	9	x 0,75	90	10	35	9	7	8,2	.0262				
	9	x 1	90	10	35	9	7	8	.0263				
	10	x 0,75	90	10	35	10	8	9,2	.0275				
	10	x 1	90	10	35	10	8	9	.0276				
	10	x 1,25	100	16	39	10	8	8,8	.0277				

DIN 374



» 124

» 124

» 124

» 125

DIN 2181



ISO 2/6H	ISO 2/6H	ISO 3/6G	ISO 3/6G
HSSE	TIN	HSSE	TIN
R45	HSSE	R45	HSSE
E / 1,5-2	E / 1,5-2	E / 1,5-2	E / 1,5-2
E / O / P	E / O / P	E / O / P	E / O / P

Product Finder

V_c

M

MF

UNC
UN-8

UNF
UNEF

G, Rp
NPSM, NPSF

NPT, NPTF
Rc, W

BSW, BSF

Pg

MJ
UNJC, UNJF

EG (STI)
SELF-LOCK

Tr, Tr-F
Rd

Zubehör
Accessories

Tech. Info



- Product Finder
- V_c
- M
- MF**
- UNC UN-8
- UNF UNEF
- G, Rp NPSM, NPSF
- NPT, NPTF Rc, W
- BSW, BSF
- Pg
- MJ UNJC, UNJF
- EG (STI) SELF-LOCK
- Tr, Tr-F Rd
- Zubehör Accessories
- Tech. Info



DIN 13

DIN 374

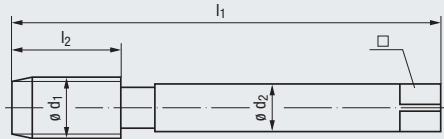

STEEL
Steel materials

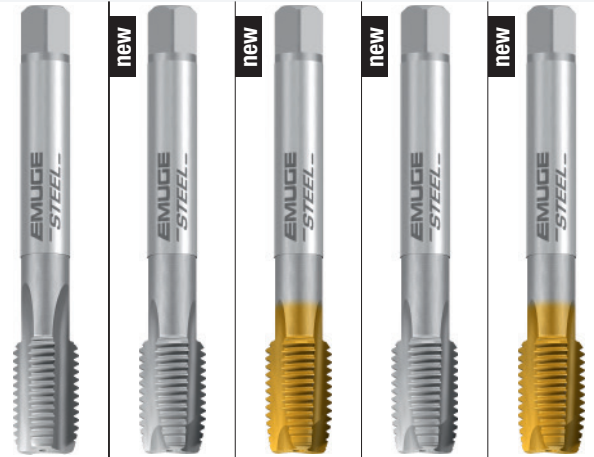

Toleranz · Tolerance
Beschichtung · Coating
Schneidstoff · Cutting material

Technische Informationen
Technical information

» 245 - 266

6HX	ISO 2/6H	ISO 2/6H	ISO 1/4H	ISO 1/4H
HSSE	HSSE	TIN HSSE	HSSE	TIN HSSE
C / 2-3	B / 4-5	B / 4-5	B / 4-5	B / 4-5
E / 0	E / 0	E / 0	E / 0	E / 0

Gewindetiefe und Lochform
Thread depth and hole type

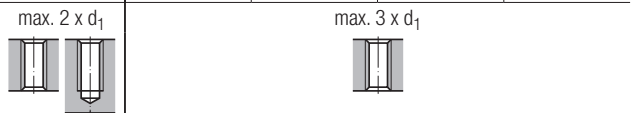

Einsatzgebiete – Material
Applications – material

» 22

P 1.1-3.1 N 2.3	P 1.1-3.1 N 2.2	P 1.1-4.1 K 2.1 N 2.2, 2.4-5	P 1.1-3.1 N 2.2	P 1.1-4.1 K 2.1 N 2.2, 2.4-5
--------------------	--------------------	------------------------------------	--------------------	------------------------------------

Werkzeug-Ident · Tool ident

M	ø d ₁ mm	P mm	l ₁	l ₂	ø d ₂	□	Dimens.- Ident	Rekord	Rekord	Rekord	Rekord	Rekord
								2A-STEEL	2B-STEEL-L	2B-STEEL-L TIN	2B-STEEL-L „4H“	2B-STEEL-L TIN „4H“
4	x	0,35	63	10	2,8	2,1	3,65	○	●	●		
4	x	0,5	63	10	2,8	2,1	3,5	○	●	●		
5	x	0,5	70	11	3,5	2,7	4,5	○	●	●		
6	x	0,5	80	13	4,5	3,4	5,5	○	●	●		
6	x	0,75	80	13	4,5	3,4	5,2	○	●	●		
8	x	0,75	80	14	6	4,9	7,2	○	●	●		
8	x	1	90	17	6	4,9	7	○	●	●	●	○
9	x	1	90	17	7	5,5	8	○	●	●		
10	x	0,75	90	18	7	5,5	9,2	○	●	●		
10	x	1	90	18	7	5,5	9	○	●	●	●	○
10	x	1,25	100	22	7	5,5	8,8	○	●	●		
11	x	1	90	18	8	6,2	10	○	●	●		
12	x	1	100	18	9	7	11	○	●	●		
12	x	1,25	100	22	9	7	10,8	○	●	●		
12	x	1,5	100	22	9	7	10,5	○	●	●	●	○
14	x	1	100	18	11	9	13	○	●	●		
14	x	1,25	100	22	11	9	12,8	○	●	●		
14	x	1,5	100	22	11	9	12,5	○	●	●	●	○
15	x	1	100	18	12	9	14	○	●	●		
16	x	1	100	18	12	9	15	○	●	●		
16	x	1,5	100	22	12	9	14,5	○	●	●	●	○
18	x	1	110	20	14	11	17	○	●	●		
18	x	1,5	110	25	14	11	16,5	○	●	●	●	○
18	x	2	125	26	14	11	16	○	●	●		
20	x	1	125	20	16	12	19	○	●	●		
20	x	1,5	125	25	16	12	18,5	○	●	●	●	○
20	x	2	140	27	16	12	18	○	●	●		
22	x	1	125	20	18	14,5	21	○	●	●		
22	x	1,5	125	25	18	14,5	20,5	○	●	●		
22	x	2	140	27	18	14,5	20	○	●	●		
24	x	1	140	20	18	14,5	23	○	●	●		
24	x	1,5	140	27	18	14,5	22,5	○	●	●		
24	x	2	140	27	18	14,5	22	○	●	●		
25	x	1,5	140	28	18	14,5	23,5	○	●	●		
26	x	1,5	140	28	18	14,5	24,5	○	●	●		

DIN 371 102

DIN 2181 130

MF



DIN 13

DIN 374

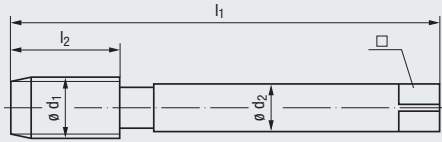

Technische Informationen
Technical information

» 245 - 266

Toleranz · Tolerance
Beschichtung · Coating
Schneidstoff · Cutting material



Gewindetiefe und Lochform
Thread depth and hole type

Einsatzgebiete – Material
Applications – material

» 22

Werkzeug-Ident · Tool ident

M	ø d ₁ mm	P mm	l ₁	l ₂	ø d ₂	□		Dimens.- Ident	STEEL				
									Rekord 2A-STEEL	Rekord 2B-STEEL-L	Rekord 2B-STEEL-L TIN	Rekord 2B-STEEL-L „4H“	Rekord 2B-STEEL-L TIN „4H“
	27	x 1,5	140	28	20	16	25,5	.0470	●	●	●		
	27	x 2	140	28	20	16	25	.0471	●	●	●		
	28	x 1,5	140	28	20	16	26,5	.0476	●	●	●		
	28	x 2	140	28	20	16	26	.0477	●	●	●		
	30	x 1,5	150	28	22	18	28,5	.0490	●	●	●		
	30	x 2	150	28	22	18	28	.0491	●	●	●		
	32	x 1,5	150	28	22	18	30,5	.0504	●	●	○		
	32	x 2	150	28	22	18	30	.0505	●	●	○		
	33	x 1,5	160	30	25	20	31,5	.0511	●	●	○		
	33	x 2	160	30	25	20	31	.0512	●	●	○		
	34	x 1,5	170	30	28	22	32,5	.0518	●	●	○		
	35	x 1,5	170	30	28	22	33,5	.0525	●	●	○		
	36	x 1,5	170	30	28	22	34,5	.0532	●	●	○		
	36	x 2	170	30	28	22	34	.0533	●	●	○		
	36	x 3	200	42	28	22	33	.0534	●	●	○		
	38	x 1,5	170	30	28	22	36,5	.0546	●	●	○		
	39	x 1,5	170	30	32	24	37,5	.0553	●	●	○		
	39	x 2	170	30	32	24	37	.0554	●	●	○		
	40	x 1,5	170	30	32	24	38,5	.0560	●	●	○		
	40	x 2	170	30	32	24	38	.0561	●	●	○		
	42	x 1,5	170	30	32	24	40,5	.0574	●	●	○		
	42	x 2	170	30	32	24	40	.0575	●	●	○		
	42	x 3	200	45	32	24	39	.0576	●	●	○		
	45	x 1,5	180	32	36	29	43,5	.0595	●	●	○		
	45	x 2	180	32	36	29	43	.0596	●	●	○		
	45	x 3	200	45	36	29	42	.0597	●	●	○		
	48	x 1,5	190	32	36	29	46,5	.0616	●	●	○		
	48	x 2	190	32	36	29	46	.0617	●	●	○		
	48	x 3	225	50	36	29	45	.0618	●	●	○		
	50	x 1,5	190	32	36	29	48,5	.0630	●	●	○		
	50	x 2	190	32	36	29	48	.0631	●	●	○		
	52	x 1,5	190	32	40	32	50,5	.0644	●	●	○		
	52	x 2	190	32	40	32	50	.0645	●	●	○		
	52	x 3	225	50	40	32	49	.0646	●	●	○		

DIN 371

102

102

102

DIN 2181

130

Product Finder

- Vc
- M
- MF**
- UNC UN-8
- UNF
- G, Rp NPSM, NPSF
- NPT, NPTF Rc, W
- BSW, BSF
- Pg
- MJ UNJC, UNJF
- EG (ST) SELF-LOCK
- Tr, Tr-F Rd
- Zubehör Accessories
- Tech. Info

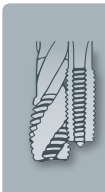

- Product Finder
- V_c
- M
- MF**
- UNC UN-8
- UNF UNEF
- G, Rp NPSM, NPSF
- NPT, NPTF Rc, W
- BSW, BSF
- Pg
- MJ UNJC, UNJF
- EG (STI) SELF-LOCK
- Tr, Tr-F Rd
- Zubehör Accessories
- Tech. Info



DIN 13

DIN 374

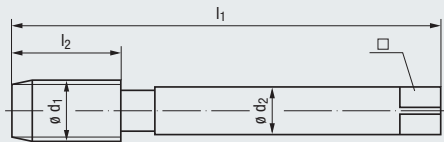

STEEL
Steel materials



Toleranz · Tolerance
Beschichtung · Coating
Schneidstoff · Cutting material

Technische Informationen
Technical information

» 245 - 266



ISO 3/6G	ISO 3/6G	ISO 2/6H	ISO 2/6H
HSSE	TIN	HSSE	TIN
HSSE	HSSE	HSSE	HSSE
B / 4-5	B / 4-5	LH	LH
E / O	E / O	B / 4-5	B / 4-5
E / O	E / O	E / O	E / O

Gewindetiefe und Lochform
Thread depth and hole type

max. 3 x d₁



Einsatzgebiete – Material
Applications – material

» 22

P 1.1-3.1	P 1.1-4.1	P 1.1-3.1	P 1.1-4.1
N 2.2	K 2.1	N 2.2	K 2.1
	N 2.2, 2.4-5		N 2.2, 2.4-5

Werkzeug-Ident · Tool ident

C0208920 C0208420 C0208950 C0208450

M	ø d ₁ mm	P mm	l ₁	l ₂	ø d ₂	□	Dimens.- Ident	Rekord	Rekord	Rekord	Rekord
								2B-STEEL-L „6G“	2B-STEEL-L TIN „6G“	2B-STEEL-L LH	2B-STEEL-L LH-TIN
	6	x 0,5	80	13	4,5	3,4	.0228				
	6	x 0,75	80	13	4,5	3,4	.0229				
	8	x 0,75	80	14	6	4,9	.0250				
	8	x 1	90	17	6	4,9	.0251	●	○	●	○
	9	x 1	90	17	7	5,5	.0263				
	10	x 0,75	90	18	7	5,5	.0275				
	10	x 1	90	18	7	5,5	.0276	●	○	●	○
	10	x 1,25	100	22	7	5,5	.0277				
	11	x 1	90	18	8	6,2	.0288				
	12	x 1	100	18	9	7	.0301	●	○	●	○
	12	x 1,25	100	22	9	7	.0302				
	12	x 1,5	100	22	9	7	.0303	●	○	●	○
	14	x 1	100	18	11	9	.0329				
	14	x 1,25	100	22	11	9	.0330				
	14	x 1,5	100	22	11	9	.0331	●	○	●	○
	15	x 1	100	18	12	9	.0343				
	16	x 1	100	18	12	9	.0357				
	16	x 1,5	100	22	12	9	.0359	●	○	●	○
	18	x 1	110	20	14	11	.0388				
	18	x 1,5	110	25	14	11	.0390	●	○	●	○
	18	x 2	125	26	14	11	.0391				
	20	x 1	125	20	16	12	.0420				
	20	x 1,5	125	25	16	12	.0422	●	○	●	○
	20	x 2	140	27	16	12	.0423				
	22	x 1	125	20	18	14,5	.0436				
	22	x 1,5	125	25	18	14,5	.0438				
	22	x 2	140	27	18	14,5	.0439				
	24	x 1	140	20	18	14,5	.0450				
	24	x 1,5	140	27	18	14,5	.0452				
	24	x 2	140	27	18	14,5	.0453				

MF



DIN 13

DIN 374

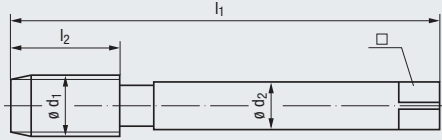

Technische Informationen
Technical information

» 245 - 266

Toleranz · Tolerance
Beschichtung · Coating
Schneidstoff · Cutting material



Gewindetiefe und Lochform
Thread depth and hole type

Einsatzgebiete – Material
Applications – material

» 22

Werkzeug-Ident · Tool ident

M	ø d ₁ mm	P mm	l ₁	l ₂	ø d ₂	□	DIN 374	Dimens.- Ident	STEEL Steel materials					
									Rekord 2B-STEEL-M	Rekord 2B-STEEL-M TIN	Rekord 2B-STEEL-H PM-CRT	Rekord 2D-STEEL	Rekord 2D-STEEL/E	
	4	x 0,35	63	10	2,8	2,1	3,65	.0209						
	4	x 0,5	63	10	2,8	2,1	3,5	.0210						
	5	x 0,5	70	11	3,5	2,7	4,5	.0218						
	6	x 0,5	80	13	4,5	3,4	5,5	.0228						
	6	x 0,75	80	13	4,5	3,4	5,2	.0229	●	●		○		
	8	x 0,75	80	14	6	4,9	7,2	.0250				○		
	8	x 1	90	17	6	4,9	7	.0251	●	●		●	●	
	9	x 1	90	17	7	5,5	8	.0263				●		●
	10	x 0,75	90	18	7	5,5	9,2	.0275				○		
	10	x 1	90	18	7	5,5	9	.0276	●	●		●	●	
	10	x 1,25	100	22	7	5,5	8,8	.0277	●	●		●	●	
	11	x 1	90	18	8	6,2	10	.0288				○		
	12	x 1	100	18	9	7	11	.0301	●	●		●	●	
	12	x 1,25	100	22	9	7	10,8	.0302	●	●		●	●	
	12	x 1,5	100	22	9	7	10,5	.0303	●	●	●	●	●	
	14	x 1	100	18	11	9	13	.0329				●		
	14	x 1,25	100	22	11	9	12,8	.0330				○		
	14	x 1,5	100	22	11	9	12,5	.0331	●	●	●	●	●	
	15	x 1	100	18	12	9	14	.0343				●		
	16	x 1	100	18	12	9	15	.0357				●		
	16	x 1,5	100	22	12	9	14,5	.0359	●	●	●	●	●	
	18	x 1	110	20	14	11	17	.0388				●		
	18	x 1,5	110	25	14	11	16,5	.0390	●	●		●	●	
	18	x 2	125	26	14	11	16	.0391				○		
	20	x 1	125	20	16	12	19	.0420				○		
	20	x 1,5	125	25	16	12	18,5	.0422	●	●		●	●	
	20	x 2	140	27	16	12	18	.0423				●		
	22	x 1	125	20	18	14,5	21	.0436				○		
	22	x 1,5	125	25	18	14,5	20,5	.0438	●	●		●	●	
	22	x 2	140	27	18	14,5	20	.0439				○		
	24	x 1	140	20	18	14,5	23	.0450				○		
	24	x 1,5	140	27	18	14,5	22,5	.0452	●	●		●	●	
	24	x 2	140	27	18	14,5	22	.0453				●		
	25	x 1,5	140	28	18	14,5	23,5	.0458				○		
	26	x 1,5	140	28	18	14,5	24,5	.0464				○		

DIN 371



102

DIN 2181



Product
Finder

V_c

M

MF

UNC
UN-8

UNF
UNEF

G, Rp
NPSM, NPSF

NPT, NPTF
Rc, W

BSW, BSF

Pg

MJ
UNJC, UNJF

EG (STI)
SELF-LOCK

Tr, Tr-F
Rd

Zubehör
Accessories

Tech. Info



- Product Finder
- V_c
- M
- MF**
- UNC UN-8
- UNF UNEF
- G, Rp NPSM, NPSF
- NPT, NPTF Rc, W
- BSW, BSF
- Pg
- MJ UNJC, UNJF
- EG (STI) SELF-LOCK
- Tr, Tr-F Rd
- Zubehör Accessories
- Tech. Info



DIN 13

DIN 374

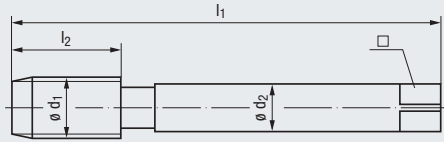

STEEL
Steel materials

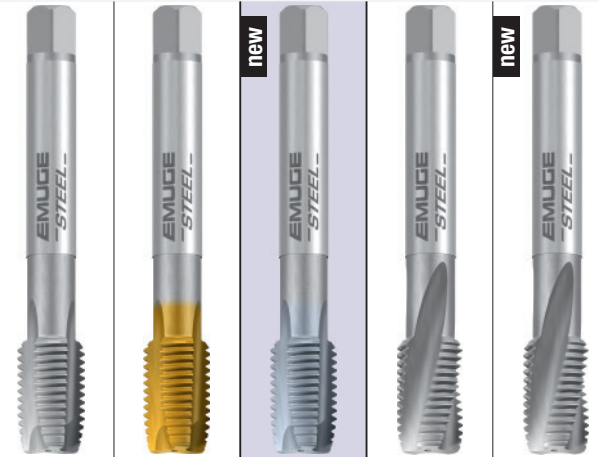

Toleranz · Tolerance
Beschichtung · Coating
Schneidstoff · Cutting material

Technische Informationen
Technical information

» 245 - 266

ISO 2/6H	ISO 2/6H	6HX	ISO 2/6H	ISO 2/6H
HSSE	HSSE	HSSE-PM	HSSE	HSSE
B / 4-5	B / 4-5	B / ≈6	C / 2-3	E / 1,5-2
E / 0	E / 0	E / 0	E / 0	E / 0

Gewindetiefe und Lochform
Thread depth and hole type

max. 3 x d₁



max. 2 x d₁



Einsatzgebiete – Material
Applications – material

» 22

P 2.1-4.1	P 2.1-4.1 K 2.1	P 3.1-5.1	P 2.1-3.1	P 2.1-3.1
-----------	--------------------	-----------	-----------	-----------

Werkzeug-Ident · Tool ident

M	ø d ₁ mm	P mm	l ₁	l ₂	ø d ₂	□	Dimens.- Ident	Rekord	Rekord	Rekord	Rekord	Rekord
								2B-STEEL-M	2B-STEEL-M TIN	2B-STEEL-H PM-CRT	2D-STEEL	2D-STEEL/E
27	x 1,5	140	28	20	16	25,5	.0470				○	
27	x 2	140	28	20	16	25	.0471				○	
28	x 1,5	140	28	20	16	26,5	.0476				○	
28	x 2	140	28	20	16	26	.0477				○	
30	x 1,5	150	28	22	18	28,5	.0490				●	
30	x 2	150	28	22	18	28	.0491				●	
32	x 1,5	150	28	22	18	30,5	.0504				○	
32	x 2	150	28	22	18	30	.0505				○	
33	x 1,5	160	30	25	20	31,5	.0511				○	
33	x 2	160	30	25	20	31	.0512				○	
34	x 1,5	170	30	28	22	32,5	.0518				○	
35	x 1,5	170	30	28	22	33,5	.0525				○	
36	x 1,5	170	30	28	22	34,5	.0532				○	
36	x 2	170	30	28	22	34	.0533				○	
36	x 3	200	42	28	22	33	.0534				○	
38	x 1,5	170	30	28	22	36,5	.0546				○	
39	x 1,5	170	30	32	24	37,5	.0553				○	
39	x 2	170	30	32	24	37	.0554				○	
40	x 1,5	170	30	32	24	38,5	.0560				○	
40	x 2	170	30	32	24	38	.0561				○	
42	x 1,5	170	30	32	24	40,5	.0574				○	
42	x 2	170	30	32	24	40	.0575				○	
42	x 3	200	45	32	24	39	.0576				○	
45	x 1,5	180	32	36	29	43,5	.0595				○	
45	x 2	180	32	36	29	43	.0596				○	
45	x 3	200	45	36	29	42	.0597				○	
48	x 1,5	190	32	36	29	46,5	.0616				○	
48	x 2	190	32	36	29	46	.0617				○	
48	x 3	225	50	36	29	45	.0618				○	
50	x 1,5	190	32	36	29	48,5	.0630				○	
50	x 2	190	32	36	29	48	.0631				○	
52	x 1,5	190	32	40	32	50,5	.0644				○	
52	x 2	190	32	40	32	50	.0645				○	
52	x 3	225	50	40	32	49	.0646				○	

DIN 371

102

DIN 2181

MF



DIN 13

DIN 374

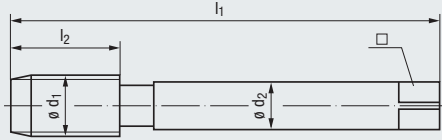

Technische Informationen
Technical information

» 245 - 266

Toleranz · Tolerance
Beschichtung · Coating
Schneidstoff · Cutting material



Gewindetiefe und Lochform
Thread depth and hole type

Einsatzgebiete – Material
Applications – material

» 22

Werkzeug-Ident · Tool ident

M	ø d ₁ mm	P mm	l ₁	l ₂	ø d ₂	□	DIN 374	Dimens.- Ident	STEEL				
									Enorm 2-STEEL	Enorm 2-STEEL TIN	Enorm 2-STEEL „4H“	Enorm 2-STEEL-LH	Enorm 2-STEEL-LH TIN
	4	x 0,35	63	5	2,8	2,1	3,65	.0209					
	4	x 0,5	63	5	2,8	2,1	3,5	.0210					
	5	x 0,5	70	5	3,5	2,7	4,5	.0218					
	6	x 0,5	80	5	4,5	3,4	5,5	.0228					
	6	x 0,75	80	8	4,5	3,4	5,2	.0229					
	8	x 0,75	80	8	6	4,9	7,2	.0250					
	8	x 1	90	10	6	4,9	7	.0251					
	9	x 1	90	10	7	5,5	8	.0263					
	10	x 0,75	90	10	7	5,5	9,2	.0275					
	10	x 1	90	10	7	5,5	9	.0276					
	10	x 1,25	100	16	7	5,5	8,8	.0277					
	11	x 1	90	11	8	6,2	10	.0288					
	12	x 1	100	11	9	7	11	.0301					
	12	x 1,25	100	15	9	7	10,8	.0302					
	12	x 1,5	100	15	9	7	10,5	.0303					
	14	x 1	100	11	11	9	13	.0329					
	14	x 1,25	100	15	11	9	12,8	.0330					
	14	x 1,5	100	15	11	9	12,5	.0331					
	15	x 1	100	12	12	9	14	.0343					
	16	x 1	100	12	12	9	15	.0357					
	16	x 1,5	100	15	12	9	14,5	.0359					
	18	x 1	110	13	14	11	17	.0388					
	18	x 1,5	110	17	14	11	16,5	.0390					
	18	x 2	125	20	14	11	16	.0391					
	20	x 1	125	14	16	12	19	.0420					
	20	x 1,5	125	17	16	12	18,5	.0422					
	20	x 2	140	20	16	12	18	.0423					
	22	x 1	125	14	18	14,5	21	.0436					
	22	x 1,5	125	17	18	14,5	20,5	.0438					
	22	x 2	140	20	18	14,5	20	.0439					
	24	x 1	140	15	18	14,5	23	.0450					
	24	x 1,5	140	20	18	14,5	22,5	.0452					
	24	x 2	140	20	18	14,5	22	.0453					
	25	x 1,5	140	20	18	14,5	23,5	.0458					
	26	x 1,5	140	20	18	14,5	24,5	.0464					

DIN 371



103

103

103

DIN 2181



max. 2,5 x d₁



P 1.1-3.1 N 2.2	P 1.1-4.1 K 2.1 N 2.2	P 1.1-3.1 N 2.2	P 1.1-3.1 N 2.2	P 1.1-4.1 K 2.1 N 2.2
--------------------	-----------------------------	--------------------	--------------------	-----------------------------

Product Finder

V_c

M

MF

UNC UN-8

UNF

G, Rp NPSM, NPSF

NPT, NPTF Rc, W

BSW, BSF

Pg

MJ UNJC, UNJF

EG (ST) SELF-LOCK

Tr, Tr-F Rd

Zubehör Accessories

Tech. Info



- Product Finder
- V_c
- M
- MF**
- UNC UN-8
- UNF UNEF
- G, Rp NPSM, NPSF
- NPT, NPTF Rc, W
- BSW, BSF
- Pg
- MJ UNJC, UNJF
- EG (STI) SELF-LOCK
- Tr, Tr-F Rd
- Zubehör Accessories
- Tech. Info



DIN 13

DIN 374

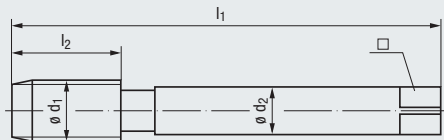

STEEL
Steel materials



Toleranz · Tolerance
Beschichtung · Coating
Schneidstoff · Cutting material

Technische Informationen
Technical information

Technical information icon: 245 - 266

Technical drawing icon: 245 - 266

ISO 2/6H	ISO 2/6H	ISO 1/4H	ISO 2/6H	ISO 2/6H
HSSE	TIN	HSSE	HSSE	TIN
R35	HSSE	R35	R35	HSSE
C / 2-3	R35	C / 2-3	LH, L35	LH, L35
E / O	C / 2-3	E / O	C / 2-3	C / 2-3
E / O	E / O	E / O	E / O	E / O

Gewindetiefe und Lochform
Thread depth and hole type

max. 2,5 x d₁



Einsatzgebiete – Material
Applications – material

Technical information icon: 22

P 1.1-3.1	P 1.1-4.1	P 1.1-3.1	P 1.1-3.1	P 1.1-4.1
N 2.2	K 2.1	N 2.2	N 2.2	K 2.1
	N 2.2			N 2.2

Werkzeug-Ident · Tool ident

M	ø d ₁ mm	P mm	l ₁	l ₂	ø d ₂	□	Image	Dimens.- Ident	Enorm 2-STEEL				
									Enorm 2-STEEL	Enorm 2-STEEL TIN	Enorm 2-STEEL „4H“	Enorm 2-STEEL-LH	Enorm 2-STEEL-LH TIN
	27	x 1,5	140	20	20	16	25,5	.0470	●				
	27	x 2	140	20	20	16	25	.0471	●				
	28	x 1,5	140	20	20	16	26,5	.0476	●				
	28	x 2	140	20	20	16	26	.0477	●				
	30	x 1,5	150	22	22	18	28,5	.0490	●				
	30	x 2	150	22	22	18	28	.0491	●				
	32	x 1,5	150	22	22	18	30,5	.0504	●				
	32	x 2	150	22	22	18	30	.0505	○				
	33	x 1,5	160	24	25	20	31,5	.0511	●				
	33	x 2	160	24	25	20	31	.0512	●				
	34	x 1,5	170	24	28	22	32,5	.0518	●				
	35	x 1,5	170	24	28	22	33,5	.0525	●				
	36	x 1,5	170	24	28	22	34,5	.0532	●				
	36	x 2	170	24	28	22	34	.0533	●				
	36	x 3	200	30	28	22	33	.0534	●				
	38	x 1,5	170	24	28	22	36,5	.0546	●				
	39	x 1,5	170	25	32	24	37,5	.0553	○				
	39	x 2	170	25	32	24	37	.0554	○				
	40	x 1,5	170	25	32	24	38,5	.0560	●				
	40	x 2	170	25	32	24	38	.0561	○				
	42	x 1,5	170	25	32	24	40,5	.0574	●				
	42	x 2	170	25	32	24	40	.0575	●				
	42	x 3	200	30	32	24	39	.0576	●				
	45	x 1,5	180	27	36	29	43,5	.0595	●				
	45	x 2	180	27	36	29	43	.0596	○				
	45	x 3	200	30	36	29	42	.0597	○				
	48	x 1,5	190	27	36	29	46,5	.0616	●				
	48	x 2	190	27	36	29	46	.0617	●				
	48	x 3	225	33	36	29	45	.0618	●				
	50	x 1,5	190	27	36	29	48,5	.0630	●				
	50	x 2	190	27	36	29	48	.0631	●				
	52	x 1,5	190	27	40	32	50,5	.0644	●				
	52	x 2	190	27	40	32	50	.0645	●				
	52	x 3	225	33	40	32	49	.0646	○				

DIN 371 103

DIN 2181

MF



DIN 13

DIN 374

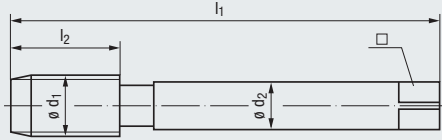

Technische Informationen
Technical information

» 245 - 266

Toleranz · Tolerance
Beschichtung · Coating
Schneidstoff · Cutting material



Gewindetiefe und Lochform
Thread depth and hole type

Einsatzgebiete – Material
Applications – material

» 22

Werkzeug-Ident · Tool ident

M	ø d ₁ mm	P mm	l ₁	l ₂	ø d ₂	□	Dimens.- Ident	max. 3 x d ₁				
								Rekord 2B-VA NT	Rekord 2B-VA TIN	Rekord 2B-VA GLT-1	Rekord 2B-VA NT „4H“	Rekord 2B-VA TIN „4H“
	6	x 0,5	80	13	4,5	3,4	5,5	●	●	●		
	6	x 0,75	80	13	4,5	3,4	5,2	●	●	●		
	8	x 0,75	80	14	6	4,9	7,2	●	●	●		
	8	x 1	90	17	6	4,9	7	●	●	●	○	○
	9	x 1	90	17	7	5,5	8					
	10	x 0,75	90	18	7	5,5	9,2					
	10	x 1	90	18	7	5,5	9	●	●	●	○	○
	10	x 1,25	100	22	7	5,5	8,8					
	11	x 1	90	18	8	6,2	10					
	12	x 1	100	18	9	7	11	●	●	●	○	○
	12	x 1,25	100	22	9	7	10,8					
	12	x 1,5	100	22	9	7	10,5	●	●	●	○	○
	14	x 1	100	18	11	9	13	○	○	○		
	14	x 1,25	100	22	11	9	12,8	○	○	○		
	14	x 1,5	100	22	11	9	12,5	○	○	○	○	○
	15	x 1	100	18	12	9	14					
	16	x 1	100	18	12	9	15	○	○	○		
	16	x 1,5	100	22	12	9	14,5	●	●	●	○	○
	18	x 1	110	20	14	11	17					
	18	x 1,5	110	25	14	11	16,5	●	●	●	○	○
	18	x 2	125	26	14	11	16					
	20	x 1	125	20	16	12	19	○	○	○		
	20	x 1,5	125	25	16	12	18,5	●	●	●	○	○
	20	x 2	140	27	16	12	18	○	○	○		
	22	x 1	125	20	18	14,5	21					
	22	x 1,5	125	25	18	14,5	20,5	●	●	●		
	22	x 2	140	27	18	14,5	20	○	○	○		
	24	x 1	140	20	18	14,5	23					
	24	x 1,5	140	27	18	14,5	22,5	●	●	●		
	24	x 2	140	27	18	14,5	22					
	25	x 1,5	140	28	18	14,5	23,5	○	○	○		
	26	x 1,5	140	28	18	14,5	24,5	○	○	○		
	27	x 1,5	140	28	20	16	25,5					
	28	x 1,5	140	28	20	16	26,5	●	●	●		
	30	x 1,5	150	28	22	18	28,5					

DIN 371

DIN 2181

VA
Stainless steel
materials

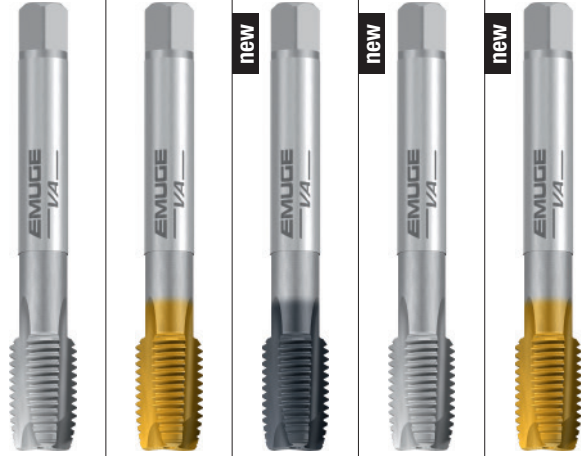

ISO 2/6H	ISO 2/6H	ISO 2/6H	ISO 1/4H	ISO 1/4H
NT	TIN	GLT-1	NT	TIN
HSSE	HSSE	HSSE	HSSE	HSSE
B / 4-5	B / 4-5	B / 4-5	B / 4-5	B / 4-5
E / O / P	E / O / P	E / O / P	E / O / P	E / O / P

- Product Finder
- Vc
- M
- MF
- UNC UN-8
- UNF
- G, Rp NPSM, NPSF
- NPT, NPTF Rc, W
- BSW, BSF
- Pg
- MJ UNJC, UNJF
- EG (ST) SELF-LOCK
- Tr, Tr-F Rd
- Zubehör Accessories
- Tech. Info

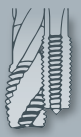

- Product Finder
- V_c
- M
- MF
- UNC UN-8
- UNF UNEF
- G, Rp NPSM, NPSF
- NPT, NPTF Rc, W
- BSW, BSF
- Pg
- MJ UNJC, UNJF
- EG (STI) SELF-LOCK
- Tr, Tr-F Rd
- Zubehör Accessories
- Tech. Info



DIN 13

DIN 374

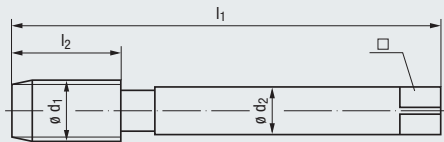

VA
Stainless steel materials

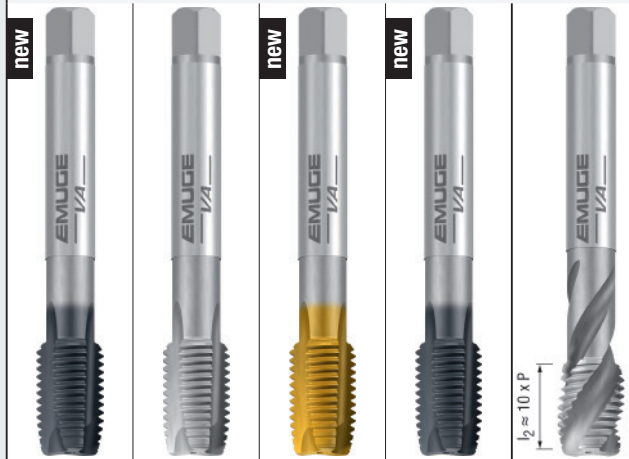

Toleranz · Tolerance
Beschichtung · Coating
Schneidstoff · Cutting material

ISO 1/4H	ISO 3/6G	ISO 3/6G	ISO 3/6G	ISO 2/6H
GLT-1	NT	TIN	GLT-1	
HSSE	HSSE	HSSE	HSSE	HSSE
B / 4-5	B / 4-5	B / 4-5	B / 4-5	C / 2-3
E / O / P	E / O / P	E / O / P	E / O / P	E / O / P

Technische Informationen
Technical information

» 245 - 266



Gewindetiefe und Lochform
Thread depth and hole type

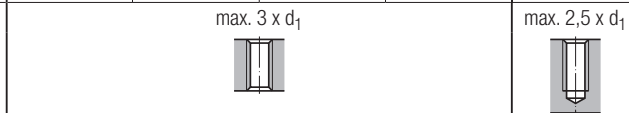

Einsatzgebiete – Material
Applications – material

» 22

P 1.1-4.1	P 1.1-3.1	P 1.1-4.1	P 1.1-4.1	P 1.1-3.1
M 1.1-3.1	M 1.1-2.1	M 1.1-3.1	M 1.1-3.1	M 1.1-2.1
K 2.1	K 2.1	K 2.1	K 2.1	K 2.1
N 2.2	N 2.2, 2.5-6	N 2.2, 2.5-6	N 2.2	

Werkzeug-Ident · Tool ident











C020C310 C0203020 C0203120 C020C320 C0503000

M	ø d ₁ mm	P mm	l ₁	l ₂	ø d ₂	□	Dimens.- Ident	Rekord 2B-VA	Rekord 2B-VA	Rekord 2B-VA	Rekord 2B-VA	Enorm 2-VA
								GLT-1 „4H“	NT „6G“	TIN „6G“	GLT-1 „6G“	
	6	x 0,5	80	13	4,5	3,4	.0228					
	6	x 0,75	80	13	4,5	3,4	.0229					●
	8	x 0,75	80	14	6	4,9	.0250					●
	8	x 1	90	17	6	4,9	.0251	○	○	○	○	●
	9	x 1	90	17	7	5,5	.0263					○
	10	x 0,75	90	18	7	5,5	.0275					●
	10	x 1	90	18	7	5,5	.0276	○	○	○	○	●
	10	x 1,25	100	22	7	5,5	.0277					○
	11	x 1	90	18	8	6,2	.0288					○
	12	x 1	100	18	9	7	.0301	○	○	○	○	●
	12	x 1,25	100	22	9	7	.0302					○
	12	x 1,5	100	22	9	7	.0303	○	○	○	○	●
	14	x 1	100	18	11	9	.0329					○
	14	x 1,25	100	22	11	9	.0330					○
	14	x 1,5	100	22	11	9	.0331	○	○	○	○	●
	15	x 1	100	18	12	9	.0343					○
	16	x 1	100	18	12	9	.0357					○
	16	x 1,5	100	22	12	9	.0359	○	○	○	○	●
	18	x 1	110	20	14	11	.0388					○
	18	x 1,5	110	25	14	11	.0390	○	○	○	○	●
	18	x 2	125	26	14	11	.0391					○
	20	x 1	125	20	16	12	.0420					○
	20	x 1,5	125	25	16	12	.0422	○	○	○	○	●
	20	x 2	140	27	16	12	.0423					○
	22	x 1	125	20	18	14,5	.0436					○
	22	x 1,5	125	25	18	14,5	.0438					●
	22	x 2	140	27	18	14,5	.0439					○
	24	x 1	140	20	18	14,5	.0450					○
	24	x 1,5	140	27	18	14,5	.0452					●
	24	x 2	140	27	18	14,5	.0453					○
	25	x 1,5	140	28	18	14,5	.0458					○
	26	x 1,5	140	28	18	14,5	.0464					●
	27	x 1,5	140	28	20	16	.0470					○
	28	x 1,5	140	28	20	16	.0476					●
	30	x 1,5	150	28	22	18	.0490					●

DIN 371

DIN 2181

103

VA Stainless steel materials		GG Cast iron		GJV Cast iron vermicular					
 new	 	  new	  	ISO 2/6H	6HX	6HX	6HX	6HX	6HX
				GLT-1	NT	TICN	TICN	TICN	TICN
				HSSE	HSSE	HSSE	HSSE-PM	HSSE-PM	HSSE-PM
				R35					
				C / 2-3	C / 2-3	C / 2-3	C / 2-3	C / 2-3	E / 1,5-2
				E / O / P	E	E	E	E	E
max. 2,5 x d ₁	max. 2 x d ₁		max. 2 x d ₁						
									
P 1.1-4.1	K 1.1-2	K 1.1-2	K 1.1-4.2						
M 1.1-3.1									
K 2.1									
C050C300	C0102001	C0109201	C010R501	C195R501	C106R501	C011R501	C196R501		
Enorm 2-VA GLT-1	Rekord 2A-GG NT	Rekord 2A-GG TICN	Rekord 2A-GJV PM-TICN	Rekord 2A-GJV IKZ-PM TICN	Rekord 2A-GJV IKZN-PM TICN	Rekord 2A-GJV/E PM-TICN	Rekord 2A-GJV/E IKZ-PM TICN		
								M 6 x 0,5	
								6 x 0,75	
								8 x 0,75	
●	●	○						8 x 1	
								9 x 1	
●	●	○						10 x 0,75	
								10 x 1	
●	●	○						10 x 1,25	
								11 x 1	
●	●	○						12 x 1	
●	●	○	●	●	○	●	●	12 x 1,25	
								12 x 1,5	
●	●	○						14 x 1	
								14 x 1,25	
●	●	○	●	●	○	●	●	14 x 1,5	
								15 x 1	
●	●	○						16 x 1	
								16 x 1,5	
●	●	○	●	●	○	●	●	18 x 1	
								18 x 1,5	
●	●	○	●	●	○	●	●	18 x 2	
								20 x 1	
●	●	○	●	●	○	●	●	20 x 1,5	
								20 x 2	
								22 x 1	
								22 x 1,5	
								22 x 2	
								24 x 1	
								24 x 1,5	
								24 x 2	
								25 x 1,5	
								26 x 1,5	
								27 x 1,5	
								28 x 1,5	
								30 x 1,5	
103									

- Product Finder
- Vc
- M
- MF
- UNC UN-8
- UNF
- G, Rp NPSM, NPSF
- NPT, NPTF Rc, W
- BSW, BSF
- Pg
- MJ UNJC, UNJF
- EG (ST) SELF-LOCK
- Tr, Tr-F Rd
- Zubehör Accessories
- Tech. Info

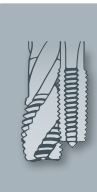

● = Lagerwerkzeug, siehe Preisliste · Stock tool, see price list
 ○ = Kurzfristig lieferbar, Preis auf Anfrage · Available on short notice, price upon inquiry

- Product Finder
- V_c
- M
- MF**
- UNC UN-8
- UNF UNEF
- G, Rp NPSM, NPSF
- NPT, NPTF Rc, W
- BSW, BSF
- Pg
- MJ UNJC, UNJF
- EG (STI) SELF-LOCK
- Tr, Tr-F Rd
- Zubehör Accessories
- Tech. Info



DIN 13

DIN 374

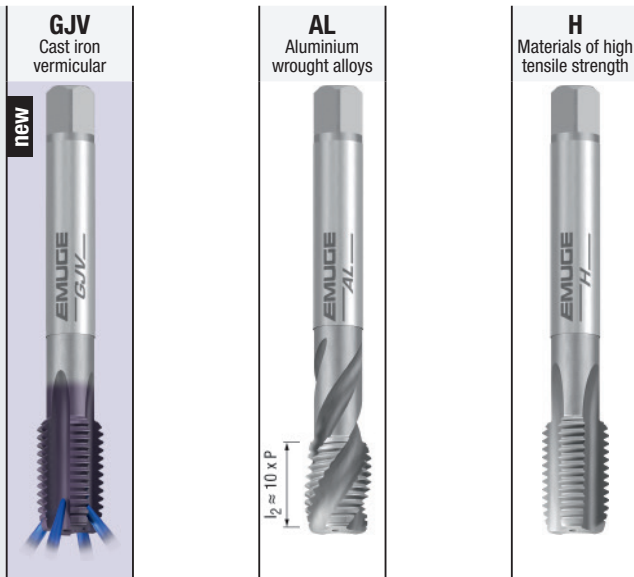
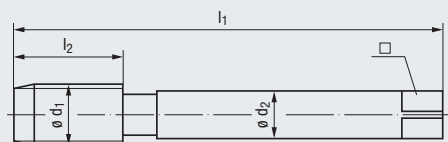

Technische Informationen Technical information	Toleranz · Tolerance Beschichtung · Coating Schneidstoff · Cutting material	6HX	ISO 2/6H	6HX
		TICN	HSSE	NT
Technische Informationen Technical information	Schneidstoff · Cutting material	HSSE-PM	HSSE	HSSE
		E / 1,5-2	R35	C / 2-3
		E	C / 2-3	C / 2-3
		E	E / O	E / O / P

Gewindetiefe und Lochform Thread depth and hole type	max. 2 x d ₁	max. 2,5 x d ₁	max. 2 x d ₁

Einsatzgebiete – Material Applications – material	K 1.1-4.2	N 1.1-4	P 1.1-3.1 K 1.1-4.2 N 2.4-7 N 4.1, 5.1





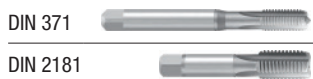









Werkzeug-Ident · Tool ident

M	ø d ₁ mm	P mm	l ₁	l ₂	ø d ₂	□		Dimens.- Ident	Rekord 2A-GJV/E IKZN-PM TICN	Enorm 2-AL	Rekord 2A-H NT
									C109R501	C0504500	C0100501
	6	x 0,5	80	13	4,5	3,4	5,5	.0228			
	6	x 0,75	80	13	4,5	3,4	5,2	.0229			
	8	x 0,75	80	14	6	4,9	7,2	.0250			
	8	x 1	90	17	6	4,9	7	.0251			○
	9	x 1	90	17	7	5,5	8	.0263			●
	10	x 0,75	90	18	7	5,5	9,2	.0275			○
	10	x 1	90	18	7	5,5	9	.0276			●
	10	x 1,25	100	22	7	5,5	8,8	.0277			●
	11	x 1	90	18	8	6,2	10	.0288			
	12	x 1	100	18	9	7	11	.0301			●
	12	x 1,25	100	22	9	7	10,8	.0302			○
	12	x 1,5	100	22	9	7	10,5 ²⁾	.0303	○	●	●
	14	x 1	100	18	11	9	13	.0329			
	14	x 1,25	100	22	11	9	12,8	.0330			○
	14	x 1,5	100	22	11	9	12,5 ²⁾	.0331	○	●	●
	15	x 1	100	18	12	9	14	.0343			○
	16	x 1	100	18	12	9	15	.0357			○
	16	x 1,5	100	22	12	9	14,5 ²⁾	.0359	○	●	●
	18	x 1	110	20	14	11	17	.0388			
	18	x 1,5	110	25	14	11	16,5	.0390	○		●
	18	x 2	125	26	14	11	16	.0391			○
	20	x 1	125	20	16	12	19	.0420			○
	20	x 1,5	125	25	16	12	18,5	.0422	○		●
	20	x 2	140	27	16	12	18	.0423			
	22	x 1	125	20	18	14,5	21	.0436			
	22	x 1,5	125	25	18	14,5	20,5	.0438			●
	22	x 2	140	27	18	14,5	20	.0439			
	24	x 1	140	20	18	14,5	23	.0450			○
	24	x 1,5	140	27	18	14,5	22,5	.0452			●
	24	x 2	140	27	18	14,5	22	.0453			○



104

²⁾ Vorbohrerdurchmesser für Gewindebohrer Rekord 2A-HCUT-PM-TICN um 0,1 mm anheben
 Increase drill diameter for taps Rekord 2A-HCUT-PM-TICN by 0.1 mm

H Materials of high tensile strength					HCUT Hardened steels	Z CNC-controlled machines		
								
6HX	6HX	6HX	6HX	6HX	6HX	6HX	6HX	
TICN	NT	TICN	TICN	KHM	TICN	TICN	TICN	
HSSE	HSSE	HSSE	HSSE		HSSE-PM	HSSE	HSSE	
C / 2-3	C / 2-3	C / 2-3	C / 2-3	C / 2-3	C / 2-3	C / 2-3	C / 2-3	
E / O / P	E / O	E / O	E / O	E / O	O / P	E / O / P	E / O	
	max. 2 x d ₁		max. 2 x d ₁	max. 2 x d ₁	max. 1,5 x d ₁	max. 2 x d ₁	max. 2 x d ₁	
								
P 1.1-4.1	P 1.1-3.1	P 1.1-4.1	P 1.1-4.1	P 5.1	H 1.1-2	P 1.1-4.1	P 1.1-4.1	
K 1.1-4.2	K 1.1-4.2	K 1.1-4.2	K 1.1-4.2	K 1.1-4.2		K 1.1-4.2	K 1.1-4.2	
N 2.4-7	N 2.4-7	N 2.4-7	N 2.4-7	N 1.5-6, 2.6-8		N 1.4-6, 2.4-7	N 1.4-6, 2.4-7	
N 4.1, 5.1	N 4.1, 5.1	N 4.1, 5.1	N 4.1, 5.1	N 4.1, 4.3-5.2		N 4.1	N 4.1	
				H 1.1-2				
C0109101	C1950501	C1959101	C1069101	C1950901	C010J901	C0109401	C1959401	
Rekord 2A-H TICN	Rekord 2A-H-IKZ NT	Rekord 2A-H-IKZ TICN	Rekord 2A-H-IKZ TICN	KHM-Rekord 2A-H-IKZ	Rekord 2A-HCUT-PM TICN	Rekord 2A-Z TICN	Rekord 2A-Z-IKZ TICN	
								M 6 x 0,5
								6 x 0,75
●						●	●	8 x 0,75
								8 x 1
								9 x 1
●								10 x 0,75
●						●	●	10 x 1
								10 x 1,25
●								11 x 1
								12 x 1
								12 x 1,25
●	●	●	○	●	●	●	●	12 x 1,5
								14 x 1
●	●	●	○	●	●	●	●	14 x 1,25
								14 x 1,5
								15 x 1
●	●	●	○	●	●	●	●	16 x 1
								16 x 1,5
●								18 x 1
								18 x 1,5
								18 x 2
								20 x 1
●	●	●	○	●				20 x 1,5
								20 x 2
								22 x 1
●								22 x 1,5
								22 x 2
●								24 x 1
								24 x 1,5
								24 x 2
				104				
					104			

1) Gewindebohren in Durchgangslöcher nur mit externer Kühlschmierung möglich
Threading in through holes is possible only with external cooling/lubrication

Product Finder

- Vc
- M
- MF
- UNC UN-8
- UNF UNEF
- G, Rp NPSM, NPSF
- NPT, NPTF Rc, W
- BSW, BSF
- Pg
- MJ UNJC, UNJF
- EG (STI) SELF-LOCK
- Tr, Tr-F Rd
- Zubehör Accessories
- Tech. Info

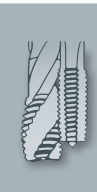

- Product Finder
- V_c
- M
- MF**
- UNC UN-8
- UNF UNEF
- G, Rp NPSM, NPSF
- NPT, NPTF Rc, W
- BSW, BSF
- Pg
- MJ UNJC, UNJF
- EG (STI) SELF-LOCK
- Tr, Tr-F Rd
- Zubehör Accessories
- Tech. Info



DIN 13

DIN 374

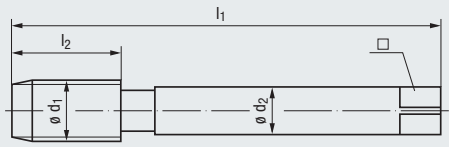

Z
CNC-controlled machines



Toleranz · Tolerance
Beschichtung · Coating
Schneidstoff · Cutting material

Technische Informationen
Technical information

» 245 - 266

6HX	6HX	6HX	6HX
TICN	TICN	TICN	TICN
HSSE	HSSE	HSSE	HSSE
C / 2-3	E / 1,5-2	E / 1,5-2	E / 1,5-2
E / O	E / O / P	E / O	E / O

Gewindetiefe und Lochform
Thread depth and hole type

max. 2 x d ₁	max. 2 x d ₁	max. 2 x d ₁	max. 2 x d ₁

Einsatzgebiete – Material
Applications – material

» 22

P 1.1-4.1	P 1.1-4.1	P 1.1-4.1	P 1.1-4.1
K 1.1-4.2	K 1.1-4.2	K 1.1-4.2	K 1.1-4.2
N 1.4-6, 2.4-7	N 1.4-6, 2.4-7	N 1.4-6, 2.4-7	N 1.4-6, 2.4-7
N 4.1	N 4.1	N 4.1	N 4.1

Werkzeug-Ident · Tool ident

C1069401 C0119401 C1969401 C1099401

M	ø d ₁ mm	P mm	l ₁	l ₂	ø d ₂	□		Dimens.- Ident	Rekord	Rekord	Rekord	Rekord
									2A-Z- IKZN TICN	2A-Z/ E TICN	2A-Z- E- IKZ TICN	2A-Z/ E- IKZN TICN
	6	x 0,5	80	5	4,5	3,4	5,5	.0228				
	6	x 0,75	80	8	4,5	3,4	5,2	.0229				
	8	x 0,75	80	8	6	4,9	7,2	.0250				
	8	x 1	90	10	6	4,9	7	.0251	○	●	●	○
	9	x 1	90	10	7	5,5	8	.0263				
	10	x 0,75	90	10	7	5,5	9,2	.0275				
	10	x 1	90	10	7	5,5	9	.0276	○	●	●	○
	10	x 1,25	100	16	7	5,5	8,8	.0277	○	●	●	○
	11	x 1	90	11	8	6,2	10	.0288				
	12	x 1	100	11	9	7	11	.0301				
	12	x 1,25	100	15	9	7	10,8	.0302				
	12	x 1,5	100	15	9	7	10,5	.0303	○	●	●	○
	14	x 1	100	11	11	9	13	.0329				
	14	x 1,25	100	15	11	9	12,8	.0330				
	14	x 1,5	100	15	11	9	12,5	.0331	○	●	●	○
	15	x 1	100	12	12	9	14	.0343				
	16	x 1	100	12	12	9	15	.0357				
	16	x 1,5	100	15	12	9	14,5	.0359	○	●	●	○
	18	x 1	110	13	14	11	17	.0388				
	18	x 1,5	110	17	14	11	16,5	.0390				
	18	x 2	125	20	14	11	16	.0391				
	20	x 1	125	14	16	12	19	.0420				
	20	x 1,5	125	17	16	12	18,5	.0422				
	20	x 2	140	20	16	12	18	.0423				
	22	x 1	125	14	18	14,5	21	.0436				
	22	x 1,5	125	17	18	14,5	20,5	.0438				
	22	x 2	140	20	18	14,5	20	.0439				
	24	x 1	140	15	18	14,5	23	.0450				
	24	x 1,5	140	20	18	14,5	22,5	.0452				
	24	x 2	140	20	18	14,5	22	.0453				

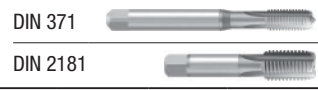

1) Gewindebohren in Durchgangslöcher nur mit externer Kühlschmierung möglich
Threading in through holes is possible only with external cooling/lubrication

Z CNC-controlled machines										
6HX	6HX	6HX	6HX	6HX	6HX	6HX	6HX	6HX		
TIN-70	GLT-1	TIN-70	GLT-1	TIN	TIN	TIN	TIN	TIN		
HSSE-PM	HSSE-PM	HSSE-PM	HSSE-PM	HSSE	HSSE	HSSE	HSSE	HSSE		
R15	R15	R15	R15	R15	R15	R15	R15	R15		
B / 4-5	B / 4-5	B / 4-5	B / 4-5	C / 2-3	C / 2-3	E / 1,5-2	C / 2-3	E / 1,5-2		
E / O / P	E / O / P	E / O	E / O	E / O / P	E / O	E / O	E / O	E / O		
max. 3 x d ₁ 				max. 2 x d ₁ 						
P 1.1-5.1	P 1.1-5.1	P 1.1-5.1	P 1.1-5.1	P 2.1-5.1	P 2.1-5.1	P 2.1-5.1	P 2.1-5.1	P 2.1-5.1		
M 1.1-3.1	M 1.1-3.1	M 1.1-3.1	M 1.1-3.1	K 2.1-2	K 2.1-2	K 2.1-2	K 2.1-2	K 2.1-2		
K 2.1	K 2.1	K 2.1	K 2.1	N 1.4-6, 2.4-5	N 1.4-6, 2.4-5	N 1.4-6, 2.4-5	N 1.4-6, 2.4-5	N 1.4-6, 2.4-5		
N 1.4-2.2, 2.4-5	N 1.4-2.2, 2.4-5	N 1.4-2.2, 2.4-5	N 1.4-2.2, 2.4-5							
S 1.1	S 1.1	S 1.1	S 1.1							
C0208F01	C020A601	C1088F01	C108A601	C0453701	C0963701	C0983701	C4253701	C4053701		
Rekord 2B-Z-PM TIN-70	Rekord 2B-Z-PM GLT-1	Rekord 2B-Z-IKZN PM-TIN-70	Rekord 2B-Z-IKZN PM-GLT-1	Rekord 2D-Z TIN	Rekord 2D-Z-IKZ TIN	Rekord 2D-Z/E-IKZ TIN	Rekord 2D-Z-BF IKZ-TIN	Rekord 2D-Z/E-BF IKZ-TIN		
									M 6 x 0,5	
									6 x 0,75	
									8 x 0,75	
									8 x 1	
									9 x 1	
									10 x 0,75	
									10 x 1	
									10 x 1,25	
									11 x 1	
									12 x 1	
									12 x 1,25	
									12 x 1,5	
									14 x 1	
									14 x 1,25	
									14 x 1,5	
									15 x 1	
									16 x 1	
									16 x 1,5	
									18 x 1	
									18 x 1,5	
									18 x 2	
									20 x 1	
									20 x 1,5	
									20 x 2	
									22 x 1	
									22 x 1,5	
									22 x 2	
									24 x 1	
									24 x 1,5	
									24 x 2	
106	106									

- Product Finder
- V_c
- M
- MF
- UNC UN-8
- UNF
- G, Rp NPSM, NPSF
- NPT, NPTF Rc, W
- BSW, BSF
- Pg
- MJ UNJC, UNJF
- EG (STI) SELF-LOCK
- Tr, Tr-F Rd
- Zubehör Accessories
- Tech. Info

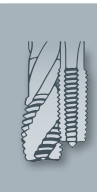

● = Lagerwerkzeug, siehe Preisliste · Stock tool, see price list
○ = Kurzfristig lieferbar, Preis auf Anfrage · Available on short notice, price upon inquiry

- Product Finder
- V_c
- M
- MF**
- UNC UN-8
- UNF UNEF
- G, Rp NPSM, NPSF
- NPT, NPTF Rc, W
- BSW, BSF
- Pg
- MJ UNJC, UNJF
- EG (STI) SELF-LOCK
- Tr, Tr-F Rd
- Zubehör Accessories
- Tech. Info



DIN 13

DIN 374

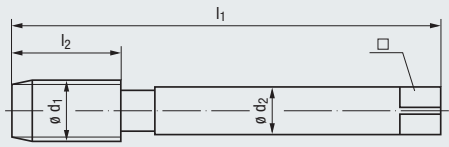

Technische Informationen
Technical information

Toleranz · Tolerance
Beschichtung · Coating
Schneidstoff · Cutting material



Gewindetiefe und Lochform
Thread depth and hole type

Einsatzgebiete – Material
Applications – material

Werkzeug-Ident · Tool ident

M	ø d ₁ mm	P mm	l ₁	l ₂	ø d ₂	□	Dimens.-Ident	Werkzeug-Ident · Tool ident				
								C5760F01	C576A601	C5810F01	C581A601	C5820F01
	6	x 0,5	80	5	4,5	3,4	.0228					
	6	x 0,75	80	8	4,5	3,4	.0229					
	8	x 0,75	80	8	6	4,9	.0250					
	8	x 1	90	10	6	4,9	.0251					
	9	x 1	90	10	7	5,5	.0263					
	10	x 0,75	90	10	7	5,5	.0275					
	10	x 1	90	10	7	5,5	.0276					
	10	x 1,25	100	16	7	5,5	.0277					
	11	x 1	90	11	8	6,2	.0288					
	12	x 1	100	11	9	7	.0301					
	12	x 1,25	100	15	9	7	.0302					
	12	x 1,5	100	15	9	7	.0303					
	14	x 1	100	11	11	9	.0329					
	14	x 1,25	100	15	11	9	.0330					
	14	x 1,5	100	15	11	9	.0331					
	15	x 1	100	12	12	9	.0343					
	16	x 1	100	12	12	9	.0357					
	16	x 1,5	100	15	12	9	.0359					
	18	x 1	110	13	14	11	.0388					
	18	x 1,5	110	17	14	11	.0390					
	18	x 2	125	20	14	11	.0391					
	20	x 1	125	14	16	12	.0420					
	20	x 1,5	125	17	16	12	.0422					
	20	x 2	140	20	16	12	.0423					
	22	x 1	125	14	18	14,5	.0436					
	22	x 1,5	125	17	18	14,5	.0438					
	22	x 2	140	20	18	14,5	.0439					
	24	x 1	140	15	18	14,5	.0450					
	24	x 1,5	140	20	18	14,5	.0452					
	24	x 2	140	20	18	14,5	.0453					

Z
CNC-controlled machines

new

6HX
TIN-60
HSSE-PM
R45
C / 2-3
E / O / P

new

6HX
GLT-1
HSSE-PM
R45
C / 2-3
E / O / P

new

6HX
TIN-60
HSSE-PM
R45
C / 2-3
E / O

new

6HX
GLT-1
HSSE-PM
R45
C / 2-3
E / O

new

6HX
TIN-60
HSSE-PM
R45
E / 1,5-2
E / O / P

max. 3 x d₁

P 2.1-4.1	P 2.1-4.1	P 2.1-4.1	P 2.1-4.1	P 2.1-4.1
M 1.1-3.1	M 1.1-3.1	M 1.1-3.1	M 1.1-3.1	M 1.1-3.1
K 2.1	K 2.1	K 2.1	K 2.1	K 2.1
N 1.4-2.2, 2.4-5	N 1.4-2.2, 2.4-5	N 1.4-2.2, 2.4-5	N 1.4-2.2, 2.4-5	N 1.4-2.2, 2.4-5
S 1.1	S 1.1	S 1.1	S 1.1	S 1.1

MF



DIN 13

DIN 374

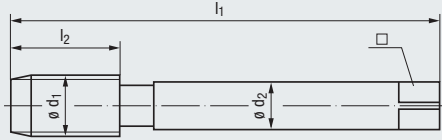

Technische Informationen
Technical information

» 245 - 266

Toleranz · Tolerance
Beschichtung · Coating
Schneidstoff · Cutting material



6HX	6HX	6HX
GLT-1	TIN-60	GLT-1
HSSE-PM	HSSE-PM	HSSE-PM
R45	R45	R45
E / 1,5-2	E / 1,5-2	E / 1,5-2
E / O / P	E / O	E / O

Gewindetiefe und Lochform
Thread depth and hole type

max. 3 x d₁



Einsatzgebiete – Material
Applications – material

» 22

P 2.1-4.1	P 2.1-4.1	P 2.1-4.1
M 1.1-3.1	M 1.1-3.1	M 1.1-3.1
K 2.1	K 2.1	K 2.1
N 1.4-2.2, 2.4-5	N 1.4-2.2, 2.4-5	N 1.4-2.2, 2.4-5
S 1.1	S 1.1	S 1.1

Werkzeug-Ident · Tool ident

C582A601 C5830F01 C583A601

M	ø d ₁ mm	P mm	l ₁	l ₂	ø d ₂	□		Dimens.- Ident	Enorm	Enorm	Enorm
									2-Z/E-X-PM GLT-1	2-Z/E-X IKZ-PM TIN-60	2-Z/E-X IKZ-PM GLT-1
	6	x 0,5	80	5	4,5	3,4	5,5	.0228	●	●	●
	6	x 0,75	80	8	4,5	3,4	5,2	.0229	●	●	●
	8	x 0,75	80	8	6	4,9	7,2	.0250	●	●	●
	8	x 1	90	10	6	4,9	7	.0251	●	●	●
	9	x 1	90	10	7	5,5	8	.0263	●	●	●
	10	x 0,75	90	10	7	5,5	9,2	.0275	●	●	●
	10	x 1	90	10	7	5,5	9	.0276	●	●	●
	10	x 1,25	100	16	7	5,5	8,8	.0277	●	●	●
	11	x 1	90	11	8	6,2	10	.0288	●	●	●
	12	x 1	100	11	9	7	11	.0301	●	●	●
	12	x 1,25	100	15	9	7	10,8	.0302	●	●	●
	12	x 1,5	100	15	9	7	10,5	.0303	●	●	●
	14	x 1	100	11	11	9	13	.0329	●	●	●
	14	x 1,25	100	15	11	9	12,8	.0330	●	●	●
	14	x 1,5	100	15	11	9	12,5	.0331	●	●	●
	15	x 1	100	12	12	9	14	.0343	●	●	●
	16	x 1	100	12	12	9	15	.0357	●	●	●
	16	x 1,5	100	15	12	9	14,5	.0359	●	●	●
	18	x 1	110	13	14	11	17	.0388	●	●	●
	18	x 1,5	110	17	14	11	16,5	.0390	●	●	●
	18	x 2	125	20	14	11	16	.0391	●	●	●
	20	x 1	125	14	16	12	19	.0420	●	●	●
	20	x 1,5	125	17	16	12	18,5	.0422	●	●	●
	20	x 2	140	20	16	12	18	.0423	●	●	●
	22	x 1	125	14	18	14,5	21	.0436	●	●	●
	22	x 1,5	125	17	18	14,5	20,5	.0438	●	●	●
	22	x 2	140	20	18	14,5	20	.0439	●	●	●
	24	x 1	140	15	18	14,5	23	.0450	●	●	●
	24	x 1,5	140	20	18	14,5	22,5	.0452	●	●	●
	24	x 2	140	20	18	14,5	22	.0453	●	●	●

- Product Finder
- V_c
- M
- MF**
- UNC UN-8
- UNF UNEF
- G, Rp NPSM, NPSF
- NPT, NPTF Rc, W
- BSW, BSF
- Pg
- MJ UNJC, UNJF
- EG (ST) SELF-LOCK
- Tr, Tr-F Rd
- Zubehör Accessories
- Tech. Info



- Product Finder
- V_c
- M
- MF**
- UNC UN-8
- UNF UNEF
- G, Rp NPSM, NPSF
- NPT, NPTF Rc, W
- BSW, BSF
- Pg
- MJ UNJC, UNJF
- EG (STI) SELF-LOCK
- Tr, Tr-F Rd
- Zubehör Accessories
- Tech. Info



DIN 13

DIN 374

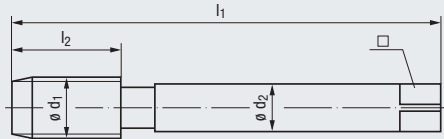

Z
CNC-controlled machines

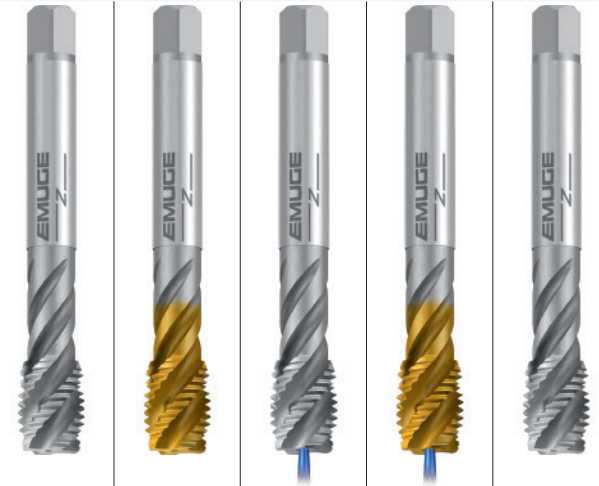

Toleranz · Tolerance
Beschichtung · Coating
Schneidstoff · Cutting material

Technische Informationen
Technical information

» 245 - 266

ISO 2/6H	ISO 2/6H	ISO 2/6H	ISO 2/6H	ISO 3/6G
HSSE	HSSE	HSSE	HSSE	HSSE
R45	R45	R45	R45	R45
E / 1,5-2	E / 1,5-2	E / 1,5-2	E / 1,5-2	E / 1,5-2
E / O / P	E / O / P	E / O	E / O	E / O / P

Gewindetiefe und Lochform
Thread depth and hole type

max. 3 x d₁



Einsatzgebiete – Material
Applications – material

» 22

P 1.1-4.1	P 1.1-4.1	P 1.1-4.1	P 1.1-4.1	P 1.1-4.1
M 1.1-2.1	M 1.1-3.1	M 1.1-2.1	M 1.1-3.1	M 1.1-2.1
N 2.1	N 1.4-6	N 2.1	N 1.4-6	N 2.1
	N 2.1-2, 2.4-5		N 2.1-2, 2.4-5	
	S 1.1		S 1.1	

Werkzeug-Ident · Tool ident

C0513500 C0513700 C0973500 C0973700 C0513520

M	ø d ₁ mm	P mm	l ₁	l ₂	ø d ₂	□	Dimens.- Ident	Enorm 2-Z/E	Enorm 2-Z/E TIN	Enorm 2-Z/E- IKZ	Enorm 2-Z/E- IKZ TIN	Enorm 2-Z/E „6G“
								●	●	○	●	○
	6	x 0,75	80	8	4,5	3,4	.0229					
	8	x 0,75	80	8	6	4,9	.0250	●				○
	8	x 1	90	10	6	4,9	.0251	●	●	○		●
	9	x 1	90	10	7	5,5	.0263					
	10	x 0,75	90	10	7	5,5	.0275					
	10	x 1	90	10	7	5,5	.0276	●	●	○		●
	10	x 1,25	100	16	7	5,5	.0277	○				○
	11	x 1	90	11	8	6,2	.0288					○
	12	x 1	100	11	9	7	.0301	●	●			●
	12	x 1,25	100	15	9	7	.0302	○	○			○
	12	x 1,5	100	15	9	7	.0303	●	●	●	●	●
	14	x 1	100	11	11	9	.0329	○				○
	14	x 1,25	100	15	11	9	.0330					
	14	x 1,5	100	15	11	9	.0331	●	●	●	●	●
	15	x 1	100	12	12	9	.0343	○				
	16	x 1	100	12	12	9	.0357	○				○
	16	x 1,5	100	15	12	9	.0359	○	●	●	●	●
	18	x 1	110	13	14	11	.0388	○				○
	18	x 1,5	110	17	14	11	.0390	●	●			○
	18	x 2	125	20	14	11	.0391					
	20	x 1	125	14	16	12	.0420	○				○
	20	x 1,5	125	17	16	12	.0422	●	●	●	●	○
	20	x 2	140	20	16	12	.0423					
	22	x 1	125	14	18	14,5	.0436					○
	22	x 1,5	125	17	18	14,5	.0438	○	○			○
	22	x 2	140	20	18	14,5	.0439					
	24	x 1	140	15	18	14,5	.0450					○
	24	x 1,5	140	20	18	14,5	.0452	○	○			○
	24	x 2	140	20	18	14,5	.0453					
	25	x 1,5	140	20	18	14,5	.0458					
	26	x 1,5	140	20	18	14,5	.0464	○	○			○
	27	x 1,5	140	20	20	16	.0470					○
	28	x 1,5	140	20	20	16	.0476	○				○
	30	x 1,5	150	22	22	18	.0490	○				○

DIN 371



107

107

107

DIN 2181



Z
CNC-controlled machines



SPEED
High-speed cutting



ISO 3/6G	6HX	6HX	6HX	6HX	6HX	6HX	6HX	6HX	6HX
TIN	TICN	TICN	TICN	TICN	TIN-70	TIN-70	TIN-60	TIN-60	TIN-60
HSSE	HSSE	HSSE	HSSE	HSSE	HSSE-PM	HSSE-PM	HSSE-PM	HSSE-PM	HSSE-PM
R45							R45	R45	R45
E / 1,5-2	C / 2-3	C / 2-3	E / 1,5-2	E / 1,5-2	B / 4-5	B / 4-5	C / 2-3	C / 2-3	C / 2-3
E / O / P	E	E	E	E	E	E	E	E	E
max. 3 x d ₁	max. 2 x d ₁	max. 2 x d ₁	max. 2 x d ₁	max. 2 x d ₁	max. 3 x d ₁		max. 3 x d ₁		
P 1.1-4.1	K 1.1-4.2	K 1.1-4.2	K 1.1-4.2	K 1.1-4.2	P 1.1-4.1	P 1.1-4.1	P 2.1-4.1	P 2.1-4.1	P 2.1-4.1
M 1.1-3.1	N 1.4-6	N 1.4-6	N 1.4-6	N 1.4-6	K 2.1-2	K 2.1-2			
N 1.4-6					N 1.4-6	N 1.4-6			
N 2.1-2, 2.4-5									
S 1.1									
C0513720	C3159401	C3179401	C3169401	C3189401	C3208F01	C3258F01	C3600F01	C3650F01	C3650F01
Enorm 2-Z/E TIN „6G“	Rekord 2A-SPEED IKZ-TICN	Rekord 2A-SPEED IKZN-TICN	Rekord 2A-SPEED/E IKZ-TICN	Rekord 2A-SPEED/E IKZN-TICN	Rekord 2B-Z-SPEED PM-TIN-70	Rekord 2B-Z-SPEED IKZN-PM TIN-70	Enorm 2-Z-SPEED X-PM TIN-60	Enorm 2-Z-SPEED X-PM TIN-60	Enorm 2-Z-SPEED X-PM TIN-60

○	●	○	○	○	●	○	●	●	M 6 x 0,75
●	●	○	○	○	●	○	●	●	8 x 0,75
									8 x 1
									9 x 1
									10 x 0,75
									10 x 1
									10 x 1,25
									11 x 1
									12 x 1
									12 x 1,25
									12 x 1,5
									14 x 1
									14 x 1,25
									14 x 1,5
									15 x 1
									16 x 1
									16 x 1,5
									18 x 1
									18 x 1,5
									18 x 2
									20 x 1
									20 x 1,5
									20 x 2
									22 x 1
									22 x 1,5
									22 x 2
									24 x 1
									24 x 1,5
									24 x 2
									25 x 1,5
									26 x 1,5
									27 x 1,5
									28 x 1,5
									30 x 1,5

107

● = Lagerwerkzeug, siehe Preisliste · Stock tool, see price list
○ = Kurzfristig lieferbar, Preis auf Anfrage · Available on short notice, price upon inquiry

Product Finder

Vc

M

MF

UNC UN-8

UNF UNEF

G, Rp NPSM, NPSF

NPT, NPTF Rc, W

BSW, BSF

Pg

MJ UNJC, UNJF

EG (ST) SELF-LOCK

Tr, Tr-F Rd

Zubehör Accessories

Tech. Info



- Product Finder
- Vc
- M
- MF**
- UNC UN-8
- UNF UNEF
- G, Rp NPSM, NPSF
- NPT, NPTF Rc, W
- BSW, BSF
- Pg
- MJ UNJC, UNJF
- EG (STI) SELF-LOCK
- Tr, Tr-F Rd
- Zubehör Accessories
- Tech. Info

MF



DIN 13

DIN 374

Mit Spanglocke
With internal chip collector

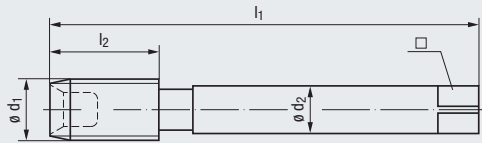

Technische Informationen
Technical information

» 245 - 266

Toleranz · Tolerance
Beschichtung · Coating
Schneidstoff · Cutting material



Gewindetiefe und Lochform
Thread depth and hole type

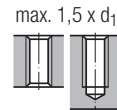

Einsatzgebiete – Material
Applications – material

» 22



NE2	6HX NE2	TIN HSSE	6HX TIN HSSE
C / 2-3 P / O 1)	C / 2-3 P / O 1)	C / 2-3 P / O 1)	C / 2-3 P / O 1)

Werkzeug-Ident · Tool ident									C0803009	C0803001	C0803109	C0803101
Ø d1 mm	P mm	l1	l2	Ø d2	□		Dimens.- Ident	Robust 2X-VA V-Nr.1 NE2	Robust 2X-VA NE2	Robust 2X-VA V-Nr.1 TIN	Robust 2X-VA TIN	
M 20	x 1,5	125	25	16	12	18,5	.0422		●		○	
22	x 1,5	125	25	18	14,5	20,5	.0438		●		○	
24	x 1,5	140	27	18	14,5	22,5	.0452		●		○	
24	x 2	140	27	18	14,5	22	.0453		●		○	
27	x 1,5	140	28	20	16	25,5	.0470		●		○	
27	x 2	140	28	20	16	25	.0471		●		○	
30	x 1,5	150	28	22	18	28,5	.0490		●		○	
33	x 1,5	160	30	25	20	31,5	.0511		●		○	
33	x 2	160	30	25	20	31	.0512		●		○	
36	x 1,5	170	30	28	22	34,5	.0532		●		○	
36	x 2	170	30	28	22	34	.0533		●		○	
36	x 3	200	42	28	22	33	.0534	○	●	○	○	
38	x 1,5	170	30	28	22	36,5	.0546		●		○	
39	x 3	200	42	32	24	36	.0555	○	●	○	○	
40	x 2	170	30	32	24	38	.0561		●		○	
42	x 1,5	170	30	32	24	40,5	.0574		●		○	
42	x 2	170	30	32	24	40	.0575		●		○	
42	x 3	200	45	32	24	39	.0576	○	●	○	○	
45	x 3	200	45	36	29	42	.0597	○	●	○	○	
48	x 1,5	190	32	36	29	46,5	.0616		●		○	
48	x 2	190	32	36	29	46	.0617		●		○	
48	x 3	225	50	36	29	45	.0618	○	●	○	○	
52	x 3	225	50	40	32	49	.0646	○	●	○	○	
56	x 3	225	50	40	32	53	.0661	○	●	○	○	
56	x 4	250	60	40	32	52	.0662	●	●	○	○	
60	x 4	280	60	45	35	56	.0672	●	●	○	○	
64	x 3	275	55	50	39	61	.0681		●		○	
64	x 4	315	65	50	39	60	.0682	●	●	○	○	
68	x 4	315	65	50	39	64	.0692	●	●	○	○	
70	x 3	275	55	50	39	67	.0696		●		○	
70	x 4	340	65	50	39	66	.0697	●	●	○	○	

MF



DIN 13

DIN 374

Mit Spanglocke
With internal chip collector

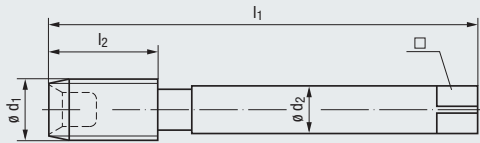

Technische Informationen
Technical information

» 245 - 266

Toleranz · Tolerance
Beschichtung · Coating
Schneidstoff · Cutting material



Gewindetiefe und Lochform
Thread depth and hole type

Einsatzgebiete – Material
Applications – material

» 22

Werkzeug-Ident · Tool ident

	Ø d ₁		P	l ₁		l ₂		Ø d ₂	□	Dimens.-Ident	C0803009	C0803001	C0803109	C0803101
	mm			mm		mm					Robust 2X-VA V-Nr.1 NE2	Robust 2X-VA NE2	Robust 2X-VA V-Nr.1 TIN	Robust 2X-VA TIN
M	72	x	3	275	55	50	39	69	.0702	●	●	○	○	
	72	x	4	340	65	50	39	68	.0703	●	●	○	○	
	72	x	6	340	80	50	39	66	.0704	●	●	○	○	
	76	x	3	275	55	50	39	73	.0714	●	●	○	○	
	76	x	4	340	65	50	39	72	.0715	●	●	○	○	
	76	x	6	340	80	50	39	70	.0716	●	●	○	○	
	80	x	4	360	65	50	39	76	.0727	●	●	○	○	
	80	x	6	360	80	50	39	74	.0728	●	●	○	○	
	85	x	3	325	60	50	39	82	.0736	●	●	○	○	
	85	x	4	380	70	50	39	81	.0737	●	●	○	○	
	90	x	3	325	60	50	39	87	.0746	●	●	○	○	
	90	x	4	380	70	50	39	86	.0747	●	●	○	○	
	90	x	6	380	80	50	39	84	.0748	●	●	○	○	
	95	x	6	400	85	56	44	89	.0758	●	●	○	○	
	100	x	4	400	70	56	44	96	.0767	●	●	○	○	
	100	x	6	400	85	56	44	94	.0768	●	●	○	○	
110	x	6	400	85	56	44	104	.0788	●	●	○	○		
115	x	3	350	65	56	44	112	.0791	●	●	○	○		
120	x	4	400	75	56	44	116	.0797	●	●	○	○		
120	x	6	400	90	56	44	114	.0798	●	●	○	○		

1) Bevorzugt mit Pastenschmierung einsetzen, neben Werkzeug auch Bohrungswandung einstreichen.
Ölschmierung ist nur bei senkrechter Grundlochbearbeitung möglich, wenn das Grundloch mit Öl vollgefüllt ist.
If possible, use paste lubrication, coating both the tool and the walls of the drilled hole.
Lubrication with oil is possible only in the vertical machining of blind holes, if the hole is entirely filled with oil.

≥ M56 Schaft mit Griffrillen!
≥ M56 Shank with grooves for better handling!

2) Robust 2X-VA-NE2 und Robust 2X-VA-TIN können auch im Satz als Fertigschneider benutzt werden.
Hierbei kann eine Gewindetiefe von bis zu 3 x d₁ hergestellt werden.
Robust 2X-VA-NE2 and Robust 2X-VA-TIN can also be used as finishing taps in a set of taps.
In this way, thread depths of up to 3 x d₁ can be produced.

Product Finder

- Vc
- M
- MF**
- UNC UN-8
- UNF UNEF
- G, Rp NPSM, NPSF
- NPT, NPTF Rc, W
- BSW, BSF
- Pg
- MJ UNJC, UNJF
- EG (ST) SELF-LOCK
- Tr, Tr-F Rd
- Zubehör Accessories
- Tech. Info



- Product Finder
- V_c
- M
- MF**
- UNC UN-8
- UNF UNEF
- G, Rp NPSM, NPSF
- NPT, NPTF Rc, W
- BSW, BSF
- Pg
- MJ UNJC, UNJF
- EG (STI) SELF-LOCK
- Tr, Tr-F Rd
- Zubehör Accessories
- Tech. Info

MF



DIN 13

Mit langen Nuten für Gewindetiefen bis max. 3 x d₁
With long flutes for thread depths up to max. 3 x d₁

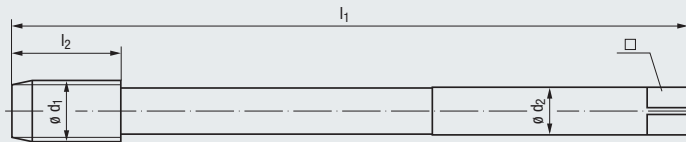

Technische Informationen Technical information	Toleranz · Tolerance Beschichtung · Coating Schneidstoff · Cutting material	6HX TiCN HSSE C / 2-3 E / O	6HX TiN HSSE R15 C / 2-3 E / O	6HX TiN HSSE R15 C / 2-3 E / O
		max. 3 x d ₁ 	max. 3 x d ₁ 	
Einsatzgebiete – Material Applications – material	245 - 266	P 1.1-4.1 K 1.1-4.2 N 1.4-6, 2.4-7 N 4.1	P 2.1-5.1 K 2.1-2 N 1.4-6, 2.4-5	P 2.1-5.1 K 2.1-2 N 1.4-6, 2.4-5
Werkzeug-Ident · Tool ident		C0579401 Rekord 2A-Z-IKZ-LF3 TiCN	C4963701 Rekord 2D-Z-IKZ-LF3 TiN	C4973701 Rekord 2D-Z-BF-IKZ-LF3 TiN
Dimens.-Ident	22 28 33	0.0453 0.0491 0.0534	○ ○ ○	○ ○ ○

1) Gewindebohren in Durchgangslöchern nur mit externer Kühlschmierung möglich
Threading in through holes is possible only with external cooling/lubrication



Spiralbohrer Typ EF-Drill Modular
siehe Seite 540 - 545

Twist drills type EF-Drill Modular,
see page 540 - 545

MF



DIN 13

Mit langen Nuten für Gewindetiefen bis max. 4 x d₁
With long flutes for thread depths up to max. 4 x d₁

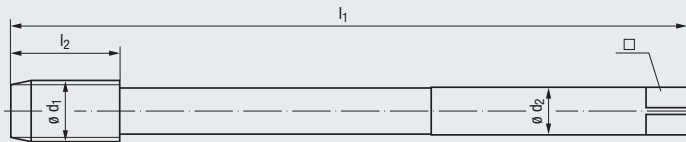

Technische Informationen
Technical information

» 245 - 266

Toleranz · Tolerance
Beschichtung · Coating
Schneidstoff · Cutting material



Gewindetiefe und Lochform
Thread depth and hole type

Einsatzgebiete – Material
Applications – material

» 22

Werkzeug-Ident · Tool ident

M	ø d ₁ mm	P mm	l ₁	l ₂	ø d ₂	□		Dimens.- Ident	C0539401	C4283701	C4063701
									Rekord 2A-Z- IKZ -LF4 TICN	Rekord 2D-Z- IKZ -LF4 TIN	Rekord 2D-Z- BF-IKZ -LF4 TIN
	24	x 2	240	20	18	14,5	22	.0453	○	○	○
	30	x 2	270	22	22	18	28	.0491	○	○	○
	36	x 3	310	30	28	22	33	.0534	○	○	○

Z
CNC-controlled
machines



6HX TICN HSSE C / 2-3 E / O	6HX TIN HSSE R15 C / 2-3 E / O	6HX TIN HSSE R15 C / 2-3 E / O
---	---	---

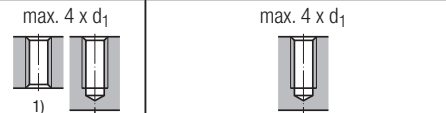

P 1.1-4.1 K 1.1-4.2 N 1.4-6, 2.4-7 N 4.1	P 2.1-5.1 K 2.1-2 N 1.4-6, 2.4-5	P 2.1-5.1 K 2.1-2 N 1.4-6, 2.4-5
---	--	--

- Product Finder
- V_c
- M
- MF**
- UNC
UN-8
- UNF
UNEF
- G, Rp
NPSM, NPSF
- NPT, NPTF
Rc, W
- BSW, BSF
- Pg
- MJ
UNJC, UNJF
- EG (STI)
SELF-LOCK
- Tr, Tr-F
Rd
- Zubehör
Accessories
- Tech. Info

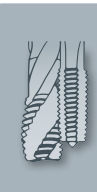

1) Gewindebohren in Durchgangslöchern nur mit externer Kühlschmierung möglich
Threading in through holes is possible only with external cooling/lubrication

- Product Finder
- V_c
- M
- MF**
- UNC UN-8
- UNF UNEF
- G, Rp NPSM, NPSF
- NPT, NPTF Rc, W
- BSW, BSF
- Pg
- MJ UNJC, UNJF
- EG (STI) SELF-LOCK
- Tr, Tr-F Rd
- Zubehör Accessories
- Tech. Info



DIN 2181

DIN 13

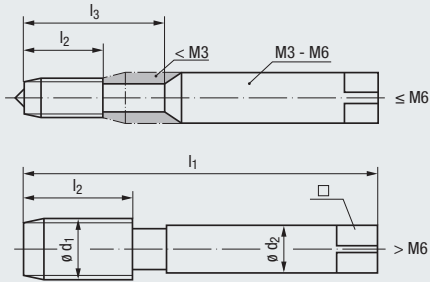

STEEL
Steel materials



Toleranz · Tolerance
Beschichtung · Coating
Schneidstoff · Cutting material

Technische Informationen
Technical information

Technical information icon: 245 - 266

Technical drawing icon: max. 2 x d₁

- 6HX
- 6HX
- HSSE
- HSSE
- LH**
- C / 2-3
- C / 2-3
- E / O
- E / O

Gewindetiefe und Lochform
Thread depth and hole type

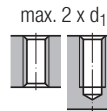

Einsatzgebiete – Material
Applications – material

Technical information icon: 22

- P 1.1-3.1
- P 1.1-3.1
- N 2.3
- N 2.3

Werkzeug-Ident · Tool ident

A0101001 A0101051

Rekord A-STEEL Rekord A-STEEL-LH

M	ø d ₁ mm	P mm	l ₁	l ₂	l ₃	ø d ₂	□	Dimens.- Ident	Rekord A-STEEL	Rekord A-STEEL-LH	
											2,15
	2,5	x 0,35	40	9	—	2,8	2,1	2,15	.0196	○	○
	2,6	x 0,35	40	9	—	2,8	2,1	2,25	.0199	○	○
	3	x 0,35	40	8	18	3,5	2,7	2,65	.0202	○	○
	3,5	x 0,35	45	8	20	4	3	3,15	.0205	○	○
	4	x 0,35	45	9	22	4,5	3,4	3,65	.0209	●	○
	4	x 0,5	45	9	22	4,5	3,4	3,5	.0210	●	○
	4,5	x 0,5	50	10	24	6	4,9	4	.0214	●	○
	5	x 0,5	50	11	25	6	4,9	4,5	.0218	●	○
	6	x 0,5	56	12	27	6	4,9	5,5	.0228	●	○
	6	x 0,75	56	12	27	6	4,9	5,2	.0229	●	○
	7	x 0,75	56	14	—	6	4,9	6,2	.0239	●	○
	8	x 0,5	56	14	—	6	4,9	7,5	.0249	●	○
	8	x 0,75	56	14	—	6	4,9	7,2	.0250	●	○
	8	x 1	63	17	—	6	4,9	7	.0251	●	○
	9	x 1	63	17	—	7	5,5	8	.0263	●	○
	10	x 0,75	63	18	—	7	5,5	9,2	.0275	●	○
	10	x 1	63	18	—	7	5,5	9	.0276	●	○
	10	x 1,25	70	22	—	7	5,5	8,8	.0277	●	○
	11	x 1	63	18	—	8	6,2	10	.0288	●	○
	12	x 1	70	18	—	9	7	11	.0301	●	○
	12	x 1,25	70	20	—	9	7	10,8	.0302	●	○
	12	x 1,5	70	20	—	9	7	10,5	.0303	●	○
	13	x 1	70	18	—	11	9	12	.0315	●	○
	14	x 1	70	18	—	11	9	13	.0329	●	○
	14	x 1,25	70	20	—	11	9	12,8	.0330	●	○
	14	x 1,5	70	20	—	11	9	12,5	.0331	●	○
	15	x 1	70	18	—	12	9	14	.0343	●	○
	15	x 1,5	70	20	—	12	9	13,5	.0345	○	○
	16	x 1	70	18	—	12	9	15	.0357	●	○
	16	x 1,5	70	20	—	12	9	14,5	.0359	●	○
	18	x 1	80	18	—	14	11	17	.0388	●	○
	18	x 1,5	80	22	—	14	11	16,5	.0390	●	○
	18	x 2	80	22	—	14	11	16	.0391	●	○
	20	x 1	80	18	—	16	12	19	.0420	○	○
	20	x 1,5	80	22	—	16	12	18,5	.0422	●	○
	20	x 2	80	22	—	16	12	18	.0423	●	○
	22	x 1	80	18	—	18	14,5	21	.0436	○	○
	22	x 1,5	80	22	—	18	14,5	20,5	.0438	●	○
	22	x 2	80	22	—	18	14,5	20	.0439	●	○
	24	x 1	90	18	—	18	14,5	23	.0450	○	○
	24	x 1,5	90	22	—	18	14,5	22,5	.0452	●	○
	24	x 2	90	22	—	18	14,5	22	.0453	●	○

MF



DIN 13

DIN 2181

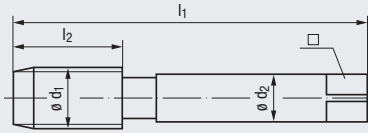

Technische Informationen
Technical information

» 245 - 266

Toleranz · Tolerance
Beschichtung · Coating
Schneidstoff · Cutting material



Gewindetiefe und Lochform
Thread depth and hole type

Einsatzgebiete – Material
Applications – material

» 22

Werkzeug-Ident · Tool ident

ø d ₁ mm	P mm	l ₁	l ₂	l ₃	ø d ₂	□		Dimens.- Ident
25	x 1,5	90	22	–	18	14,5	23,5	.0458
26	x 1,5	90	22	–	18	14,5	24,5	.0464
27	x 1,5	90	22	–	20	16	25,5	.0470
27	x 2	90	22	–	20	16	25	.0471
28	x 1,5	90	22	–	20	16	26,5	.0476
30	x 1	90	18	–	22	18	29	.0488
30	x 1,5	90	22	–	22	18	28,5	.0490
30	x 2	90	22	–	22	18	28	.0491
32	x 1,5	90	22	–	22	18	30,5	.0504
33	x 1,5	100	25	–	25	20	31,5	.0511
33	x 2	100	25	–	25	20	31	.0512
34	x 1,5	100	25	–	28	22	32,5	.0518
35	x 1,5	100	25	–	28	22	33,5	.0525
36	x 1,5	100	25	–	28	22	34,5	.0532
36	x 2	125	30	–	28	22	34	.0533
36	x 3	125	36	–	28	22	33	.0534
38	x 1,5	100	25	–	28	22	36,5	.0546
39	x 2	125	30	–	32	24	37	.0554
39	x 3	125	36	–	32	24	36	.0555
40	x 1,5	110	25	–	32	24	38,5	.0560
40	x 2	125	30	–	32	24	38	.0561
40	x 3	125	36	–	32	24	37	.0562
42	x 1,5	110	25	–	32	24	40,5	.0574
42	x 2	125	30	–	32	24	40	.0575
42	x 3	125	36	–	32	24	39	.0576
45	x 1,5	110	25	–	36	29	43,5	.0595
45	x 2	125	30	–	36	29	43	.0596
45	x 3	125	36	–	36	29	42	.0597
48	x 1,5	140	25	–	36	29	46,5	.0616
48	x 2	140	30	–	36	29	46	.0617
48	x 3	140	36	–	36	29	45	.0618
50	x 1,5	140	25	–	36	29	48,5	.0630
50	x 2	140	30	–	36	29	48	.0631
50	x 3	140	36	–	36	29	47	.0632
52	x 1,5	140	25	–	40	32	50,5	.0644
52	x 2	140	32	–	40	32	50	.0645
52	x 3	140	40	–	40	32	49	.0646

DIN 371 

DIN 374 

STEEL
Steel materials



6HX 6HX
HSSE HSSE
LH
C / 2-3 C / 2-3
E / O E / O

max. 2 x d₁

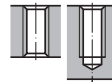

P 1.1-3.1 P 1.1-3.1
N 2.3 N 2.3

A0101001 A0101051
Rekord A-STEEL Rekord A-STEEL-LH

Product Finder

V_c

M

MF

UNC UN-8

UNF UNEF

G, Rp NPSM, NPSF

NPT, NPTF Rc, W

BSW, BSF

Pg

MJ UNJC, UNJF

EG (ST) SELF-LOCK

Tr, Tr-F Rd

Zubehör Accessories

Tech. Info



- Product Finder
- V_c
- M
- MF**
- UNC UN-8
- UNF UNEF
- G, Rp NPSM, NPSF
- NPT, NPTF Rc, W
- BSW, BSF
- Pg
- MJ UNJC, UNJF
- EG (STI) SELF-LOCK
- Tr, Tr-F Rd
- Zubehör Accessories
- Tech. Info



DIN 2181

DIN 13

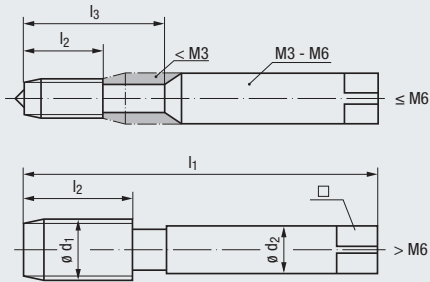

Toleranz · Tolerance
Beschichtung · Coating
Schneidstoff · Cutting material

Technische Informationen
Technical information

» 245 - 266



6HX

HSSE

D / 3-4 C / 2-3

O / P O / P

Gewindetiefe und Lochform
Thread depth and hole type

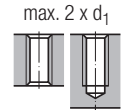
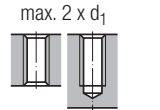

P 1.1-3.1 P 1.1-3.1 P 1.1-3.1

Einsatzgebiete – Material
Applications – material

» 22

Werkzeug-Ident · Tool ident

H0211009 H0211001 H0201001

M	ø d ₁ mm	P mm	l ₁	l ₂	l ₃	ø d ₂	□	Image	Dimens.- Ident	HGB-Set	HGB-Set	HGB-Set
										V-Nr.1	F	2S
										(Nr.1, F)		
	2,5	x 0,35	40	9	–	2,8	2,1	2,15	.0196	○	○	○
	2,6	x 0,35	40	9	–	2,8	2,1	2,25	.0199			
	3	x 0,35	40	8	18	3,5	2,7	2,65	.0202	○	○	○
	3,5	x 0,35	45	8	20	4	3	3,15	.0205			
	4	x 0,35	45	9	22	4,5	3,4	3,65	.0209	●	●	●
	4	x 0,5	45	9	22	4,5	3,4	3,5	.0210	●	●	●
	4,5	x 0,5	50	10	24	6	4,9	4	.0214			
	5	x 0,5	50	11	25	6	4,9	4,5	.0218	●	●	●
	6	x 0,5	56	12	27	6	4,9	5,5	.0228	●	●	●
	6	x 0,75	56	12	27	6	4,9	5,2	.0229	●	●	●
	7	x 0,75	56	14	–	6	4,9	6,2	.0239			
	8	x 0,5	56	14	–	6	4,9	7,5	.0249	●	●	●
	8	x 0,75	56	14	–	6	4,9	7,2	.0250	●	●	●
	8	x 1	63	17	–	6	4,9	7	.0251	●	●	●
	9	x 1	63	17	–	7	5,5	8	.0263			
	10	x 0,75	63	18	–	7	5,5	9,2	.0275	●	●	●
	10	x 1	63	18	–	7	5,5	9	.0276	●	●	●
	10	x 1,25	70	22	–	7	5,5	8,8	.0277	●	●	●
	11	x 1	63	18	–	8	6,2	10	.0288			
	12	x 1	70	18	–	9	7	11	.0301	●	●	●
	12	x 1,25	70	20	–	9	7	10,8	.0302	●	●	●
	12	x 1,5	70	20	–	9	7	10,5	.0303	●	●	●
	13	x 1	70	18	–	11	9	12	.0315			
	14	x 1	70	18	–	11	9	13	.0329	●	●	●
	14	x 1,25	70	20	–	11	9	12,8	.0330	●	●	●
	14	x 1,5	70	20	–	11	9	12,5	.0331	●	●	●
	15	x 1	70	18	–	12	9	14	.0343			
	15	x 1,5	70	20	–	12	9	13,5	.0345			
	16	x 1	70	18	–	12	9	15	.0357	●	●	●
	16	x 1,5	70	20	–	12	9	14,5	.0359	●	●	●
	18	x 1	80	18	–	14	11	17	.0388	●	●	●
	18	x 1,5	80	22	–	14	11	16,5	.0390	●	●	●
	18	x 2	80	22	–	14	11	16	.0391	●	●	●
	20	x 1	80	18	–	16	12	19	.0420	●	●	●
	20	x 1,5	80	22	–	16	12	18,5	.0422	●	●	●
	20	x 2	80	22	–	16	12	18	.0423	●	●	●
	22	x 1	80	18	–	18	14,5	21	.0436	●	●	●
	22	x 1,5	80	22	–	18	14,5	20,5	.0438	●	●	●
	22	x 2	80	22	–	18	14,5	20	.0439	●	●	●
	24	x 1	90	18	–	18	14,5	23	.0450	●	●	●

MF



DIN 13

DIN 2181

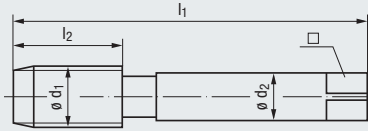

Technische Informationen
Technical information

» 245 - 266

Toleranz · Tolerance
Beschichtung · Coating
Schneidstoff · Cutting material



6HX
HSSE
D / 3-4
O / P

6HX
HSSE
C / 2-3
O / P

Gewindetiefe und Lochform
Thread depth and hole type

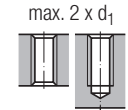
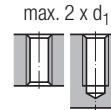

Einsatzgebiete – Material
Applications – material

» 22

P 1.1-3.1

P 1.1-3.1

Werkzeug-Ident · Tool ident

H0211009	H0211001	H0201001
HGB-Set V-Nr.1	HGB-Set F	HGB-Set 2S (Nr.1, F)

M	ø d ₁ mm	P mm	l ₁	l ₂	l ₃	ø d ₂	□	Image	Dimens.- Ident	HGB-Set		
										V-Nr.1	F	2S
	24	x 1,5	90	22	–	18	14,5	22,5	.0452	○	○	○
	24	x 2	90	22	–	18	14,5	22	.0453	○	○	○
	25	x 1,5	90	22	–	18	14,5	23,5	.0458	○	○	○
	26	x 1,5	90	22	–	18	14,5	24,5	.0464	○	○	○
	27	x 1,5	90	22	–	20	16	25,5	.0470	○	○	○
	27	x 2	90	22	–	20	16	25	.0471	○	○	○
	28	x 1,5	90	22	–	20	16	26,5	.0476	○	○	○
	30	x 1	90	18	–	22	18	29	.0488	○	○	○
	30	x 1,5	90	22	–	22	18	28,5	.0490	○	○	○
	30	x 2	90	22	–	22	18	28	.0491	○	○	○
	32	x 1,5	90	22	–	22	18	30,5	.0504	○	○	○
	33	x 1,5	100	25	–	25	20	31,5	.0511	○	○	○
	33	x 2	100	25	–	25	20	31	.0512	○	○	○
	34	x 1,5	100	25	–	28	22	32,5	.0518	○	○	○
	35	x 1,5	100	25	–	28	22	33,5	.0525	○	○	○
	36	x 1,5	100	25	–	28	22	34,5	.0532	○	○	○
	36	x 2	125	30	–	28	22	34	.0533	○	○	○
	36	x 3	125	36	–	28	22	33	.0534	○	○	○
	38	x 1,5	100	25	–	28	22	36,5	.0546	○	○	○
	39	x 2	125	30	–	32	24	37	.0554	○	○	○
	39	x 3	125	36	–	32	24	36	.0555	○	○	○
	40	x 1,5	110	25	–	32	24	38,5	.0560	○	○	○
	40	x 2	125	30	–	32	24	38	.0561	○	○	○
	40	x 3	125	36	–	32	24	37	.0562	○	○	○
	42	x 1,5	110	25	–	32	24	40,5	.0574	○	○	○
	42	x 2	125	30	–	32	24	40	.0575	○	○	○
	42	x 3	125	36	–	32	24	39	.0576	○	○	○
	45	x 1,5	110	25	–	36	29	43,5	.0595	○	○	○
	45	x 2	125	30	–	36	29	43	.0596	○	○	○
	45	x 3	125	36	–	36	29	42	.0597	○	○	○
	48	x 1,5	140	25	–	36	29	46,5	.0616	○	○	○
	48	x 2	140	30	–	36	29	46	.0617	○	○	○
	48	x 3	140	36	–	36	29	45	.0618	○	○	○
	50	x 1,5	140	25	–	36	29	48,5	.0630	○	○	○
	50	x 2	140	30	–	36	29	48	.0631	○	○	○
	50	x 3	140	36	–	36	29	47	.0632	○	○	○
	52	x 1,5	140	25	–	40	32	50,5	.0644	○	○	○
	52	x 2	140	32	–	40	32	50	.0645	○	○	○
	52	x 3	140	40	–	40	32	49	.0646	○	○	○

● = Lagerwerkzeug, siehe Preisliste · Stock tool, see price list
○ = Kurzfristig lieferbar, Preis auf Anfrage · Available on short notice, price upon inquiry

Product Finder

V_c

M

MF

UNC UN-8

UNF UNEF

G, Rp NPSM, NPSF

NPT, NPTF Rc, W

BSW, BSF

Pg

MJ UNJC, UNJF

EG (ST) SELF-LOCK

Tr, Tr-F Rd

Zubehör Accessories

Tech. Info



- Product Finder
- V_c
- M
- MF**
- UNC UN-8
- UNF UNEF
- G, Rp NPSM, NPSF
- NPT, NPTF Rc, W
- BSW, BSF
- Pg
- MJ UNJC, UNJF
- EG (STI) SELF-LOCK
- Tr, Tr-F Rd
- Zubehör Accessories
- Tech. Info



DIN 2181

DIN 13

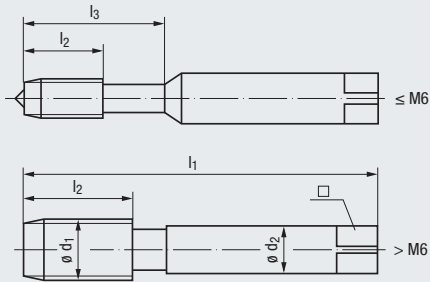

Toleranz · Tolerance
Beschichtung · Coating
Schneidstoff · Cutting material

Technische Informationen
Technical information

» 245 - 266



6HX
HSSE
LH
D / 3-4
O / P

6HX
HSSE
LH
C / 2-3
O / P

Gewindetiefe und Lochform
Thread depth and hole type

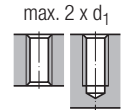
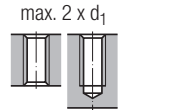

P 1.1-3.1

P 1.1-3.1

Einsatzgebiete – Material
Applications – material

» 22

Werkzeug-Ident · Tool ident

H0211059 H0211051 H0201051

M	ø d ₁ mm	P mm	l ₁	l ₂	l ₃	ø d ₂	□	Icon	Dimens.- Ident	HGB-Set	HGB-Set	HGB-Set
										LH-V-Nr.1	LH-F	LH-2S (Nr.1, F)
	6	x 0,5	56	12	27	6	4,9	5,5	.0228			
	6	x 0,75	56	12	27	6	4,9	5,2	.0229			
	7	x 0,75	56	14	—	6	4,9	6,2	.0239			
	8	x 0,5	56	14	—	6	4,9	7,5	.0249			
	8	x 0,75	56	14	—	6	4,9	7,2	.0250			
	8	x 1	63	17	—	6	4,9	7	.0251	○	○	○
	9	x 1	63	17	—	7	5,5	8	.0263			
	10	x 0,75	63	18	—	7	5,5	9,2	.0275			
	10	x 1	63	18	—	7	5,5	9	.0276	○	○	○
	10	x 1,25	70	22	—	7	5,5	8,8	.0277			
	11	x 1	63	18	—	8	6,2	10	.0288			
	12	x 1	70	18	—	9	7	11	.0301	○	○	○
	12	x 1,25	70	20	—	9	7	10,8	.0302			
	12	x 1,5	70	20	—	9	7	10,5	.0303	○	○	○
	13	x 1	70	18	—	11	9	12	.0315			
	14	x 1	70	18	—	11	9	13	.0329			
	14	x 1,25	70	20	—	11	9	12,8	.0330			
	14	x 1,5	70	20	—	11	9	12,5	.0331	○	○	○
	15	x 1	70	18	—	12	9	14	.0343			
	15	x 1,5	70	20	—	12	9	13,5	.0345			
	16	x 1	70	18	—	12	9	15	.0357			
	16	x 1,5	70	20	—	12	9	14,5	.0359	○	○	○
	18	x 1	80	18	—	14	11	17	.0388			
	18	x 1,5	80	22	—	14	11	16,5	.0390	○	○	○
	18	x 2	80	22	—	14	11	16	.0391			
	20	x 1	80	18	—	16	12	19	.0420			
	20	x 1,5	80	22	—	16	12	18,5	.0422	○	○	○
	20	x 2	80	22	—	16	12	18	.0423			
	22	x 1	80	18	—	18	14,5	21	.0436			
	22	x 1,5	80	22	—	18	14,5	20,5	.0438	○	○	○
	22	x 2	80	22	—	18	14,5	20	.0439			
	24	x 1	90	18	—	18	14,5	23	.0450			
	24	x 1,5	90	22	—	18	14,5	22,5	.0452	○	○	○
	24	x 2	90	22	—	18	14,5	22	.0453			

MF



DIN 13

DIN 2181

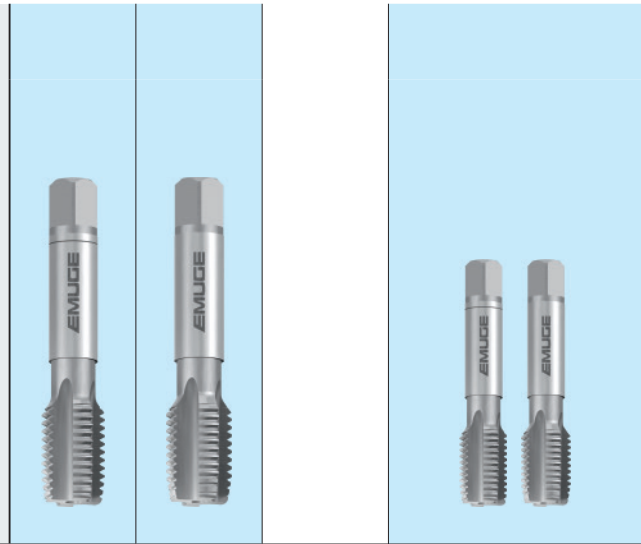
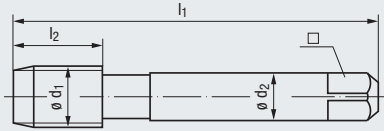

- Product Finder
- Vc
- M
- MF**
- UNC UN-8
- UNF UNEF
- G, Rp NPSM, NPSF
- NPT, NPTF Rc, W
- BSW, BSF
- Pg
- MJ UNJC, UNJF
- EG (ST) SELF-LOCK
- Tr, Tr-F Rd
- Zubehör Accessories
- Tech. Info

Toleranz · Tolerance
Beschichtung · Coating
Schneidstoff · Cutting material

Technische Informationen
Technical information

» 245 - 266

6HX

VHM/KHM

C / ≈3

O / P

6HX

VHM/KHM

C / ≈3

O / P

Gewindetiefe und Lochform
Thread depth and hole type

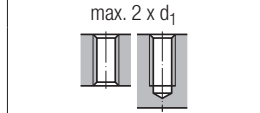
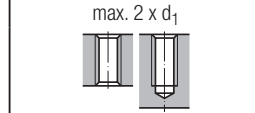

Einsatzgebiete – Material
Applications – material

» 22

P 5.1

N 2.8, 5.2

H 1.1-3

P 5.1

N 2.8, 5.2

H 1.1-3

Werkzeug-Ident · Tool ident

M	ø d ₁ mm	P mm	l ₁	l ₂	ø d ₂	□		Dimens.- Ident	H0330909	H0330901	H0320901
									VHM/KHM Set V-Nr.1	VHM/KHM Set F	VHM/KHM Set 2S (Nr.1, F)
	8	x 1	63	10	6	4,9	7	.0251	○	○	○
	10	x 1	63	10	7	5,5	9	.0276	○	○	○
	12	x 1,5	70	15	9	7	10,5	.0303	○	○	○
	14	x 1,5	70	15	11	9	12,5	.0331	○	○	○
	16	x 1,5	70	15	12	9	14,5	.0359	○	○	○

- Product Finder
- V_c
- M
- MF**
- UNC UN-8
- UNF UNEF
- G, Rp NPSM, NPSF
- NPT, NPTF Rc, W
- BSW, BSF
- Pg
- MJ UNJC, UNJF
- EG (STI) SELF-LOCK
- Tr, Tr-F Rd
- Zubehör Accessories
- Tech. Info



DIN 2181

DIN 13

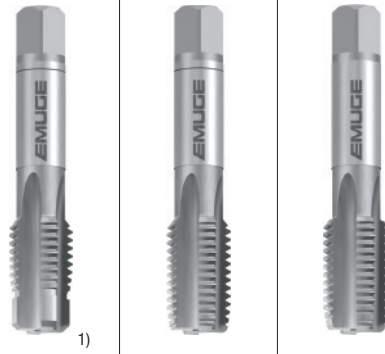
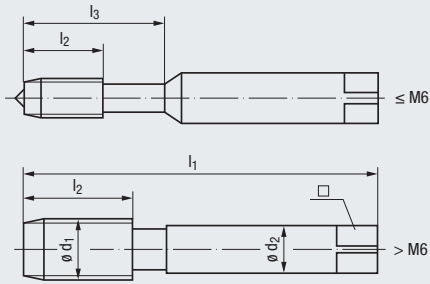

Toleranz · Tolerance
Beschichtung · Coating
Schneidstoff · Cutting material

Technische Informationen
Technical information

Technical information icon: 245 - 266

Technical drawing icon: max. 2 x d₁

HSSE
C / 2-3
O / P

HSSE
C / 2-3
O / P

6HX
HSSE
C / 2-3
O / P

Gewindetiefe und Lochform
Thread depth and hole type

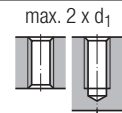

Einsatzgebiete – Material
Applications – material

Technical drawing icon: 22

P 1.1-5.1
M 1.1-4.1
S 2.1-2, 2.4

P 1.1-5.1
M 1.1-4.1
S 2.1-2, 2.4

P 1.1-5.1
M 1.1-4.1
S 2.1-2, 2.4

Werkzeug-Ident · Tool ident



H0463009

H0473009

H0473001

	Ø d ₁ mm	P mm	l ₁	l ₂	l ₃	Ø d ₂	□	Dimens.- Ident	WM-Set V-Nr.1Z	WM-Set V-Nr.1	WM-Set F	
M	6	x 0,75	56	12	27	6	4,9	5,2	.0229	○	○	○
	8	x 0,75	56	14	–	6	4,9	7,2	.0250	○	○	○
	8	x 1	63	17	–	6	4,9	7	.0251	●	●	●
	10	x 1	63	18	–	7	5,5	9	.0276	●	●	●
	12	x 1	70	18	–	9	7	11	.0301	○	○	○
	12	x 1,5	70	20	–	9	7	10,5	.0303	●	●	●
	14	x 1,5	70	20	–	11	9	12,5	.0331	●	●	●
	16	x 1,5	70	20	–	12	9	14,5	.0359	●	●	●
	18	x 1,5	80	22	–	14	11	16,5	.0390	○	○	○
	20	x 1,5	80	22	–	16	12	18,5	.0422	○	○	○
	22	x 1,5	80	22	–	18	14,5	20,5	.0438	○	○	○
	24	x 1,5	90	22	–	18	14,5	22,5	.0452	○	○	○

1) Der Vorschneider Nr.1Z mit Führungszapfen ist eine zusätzliche Hilfe zum winkelrechten Anschneiden von Hand. Er kann z.B. auf der Maschine weggelassen werden. Die Profilabstufung von Nr.1Z und Nr.1 ist gleich.
The taper tap No. 1Z with cylindrical pilot is an additional aid for true alignment especially when tapping by hand. It can be deleted when tapping by machine. The profile graduation of No.1Z, and No.1 is the same.

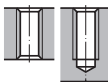
 <p>2)</p>				<p>Product Finder</p> <p>V_c</p> <p>M</p> <p>MF</p> <p>UNC UN-8</p> <p>UNF UNEF</p> <p>G, Rp NPSM, NPSF</p> <p>NPT, NPTF Rc, W</p> <p>BSW, BSF</p> <p>Pg</p> <p>MJ UNJC, UNJF</p> <p>EG (STI) SELF-LOCK</p> <p>Tr, Tr-F Rd</p> <p>Zubehör Accessories</p> <p>Tech. Info</p>
<p>6HX</p> <p>HSSE</p> <p>C / 2-3</p> <p>O / P</p>	<p>6HX</p> <p>HSSE</p> <p>C / 2-3</p> <p>O / P</p>			
<p>max. 2 x d₁</p> 				
<p>P 1.1-5.1</p> <p>M 1.1-4.1</p> <p>S 2.1-2, 2.4</p>	<p>P 1.1-5.1</p> <p>M 1.1-4.1</p> <p>S 2.1-2, 2.4</p>			
<p>H0453001</p> <p>WM-Set</p> <p>3S</p> <p>(Nr.1Z, Nr.1, F)</p>	<p>H0483001</p> <p>WM-Set</p> <p>2S</p> <p>(Nr.1, F)</p>			
<p>○</p> <p>○</p> <p>●</p> <p>●</p> <p>○</p> <p>●</p> <p>●</p> <p>●</p> <p>○</p> <p>○</p> <p>○</p> <p>○</p>	<p>○</p> <p>○</p> <p>●</p> <p>●</p> <p>○</p> <p>●</p> <p>●</p> <p>●</p> <p>○</p> <p>○</p> <p>○</p> <p>○</p>			<p>M 6 x 0,75</p> <p>8 x 0,75</p> <p>8 x 1</p> <p>10 x 1</p> <p>12 x 1</p> <p>12 x 1,5</p> <p>14 x 1,5</p> <p>16 x 1,5</p> <p>18 x 1,5</p> <p>20 x 1,5</p> <p>22 x 1,5</p> <p>24 x 1,5</p>

2) Beim Gewindebohren von Hand in Durchgangslöcher entfällt Nr.1
No.1 is not needed when tapping in through holes by hand



Verstellbare Windeisen siehe Seite 243

Adjustable tap wrenches, see page 243

- Product Finder
- V_c
- M
- MF**
- UNC UN-8
- UNF UNEF
- G, Rp NPSM, NPSF
- NPT, NPTF Rc, W
- BSW, BSF
- Pg
- MJ UNJC, UNJF
- EG (STI) SELF-LOCK
- Tr, Tr-F Rd
- Zubehör Accessories
- Tech. Info



MF

DIN 13

Für dünnwandige Messing-Rohre
For thin-walled brass tubes

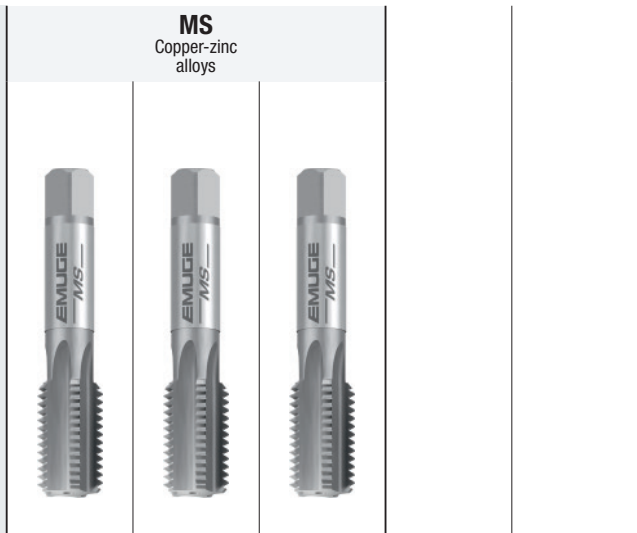
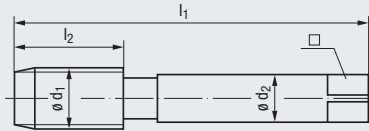

Technische Informationen Technical information ▶ 245 - 266	Toleranz · Tolerance	6HX	6HX +0,1 2)	6GX
	Beschichtung · Coating	HSSE	HSSE	HSSE
	Schneidstoff · Cutting material	max. 1	max. 1	max. 1
		E	E	E
Gewindetiefe und Lochform Thread depth and hole type	max. 1 x d ₁ 			

Einsatzgebiete – Material Applications – material ▶ 22	N 2,3,2,6	N 2,3,2,6	N 2,3,2,6
--	-----------	-----------	-----------

Werkzeug-Ident · Tool ident									A6622501	A662254A	A6622521
∅ d ₁ mm	P mm	l ₁	l ₂	∅ d ₂	□		Dimens.- Ident	AUT-A MS-R	AUT-A MS-R „+0,1“	AUT-A MS-R „6GX“	
M 8	x 1	63	17	6	4,9	7	.0251	○		○	
10	x 1	63	18	7	5,5	9	.0276	○	○	○	
12	x 1	70	18	9	7	11	.0301	○	○	○	
12	x 1,5	70	20	9	7	10,5	.0303	○		○	
14	x 1	70	18	10 1)	8	13	.0329		○	○	
14	x 1,5	70	20	10 1)	8	12,5	.0331	○		○	
15	x 1	70	18	12	9	14	.0343			○	
16	x 1,5	70	20	12	9	14,5	.0359	○	○	○	
17	x 1	70	18	12	9	16	.0372			○	
18	x 1,5	80	22	12 1)	9	16,5	.0390	○		○	
20	x 1,5	80	22	15 1)	12	18,5	.0422	○		○	
22	x 1,5	80	22	15 1)	12	20,5	.0438	○		○	
24	x 1,5	90	22	18	14,5	22,5	.0452	○		○	
26	x 1,5	90	22	18	14,5	24,5	.0464	○		○	
28	x 1,5	90	22	18 1)	14,5	26,5	.0476	○		○	
30	x 1,5	90	22	18 1)	14,5	28,5	.0490	○		○	

1) Spezieller AUT-Schaft
Special shank for "AUT" taps

2) Vorbohrdurchmesser für Gewindebohrer mit Übermaß um 0,1 mm anheben
Increase drill diameter for taps with oversize by 0.1 mm



Automatengewindebohrer für
Metrisches ISO-Regelgewinde DIN 13
auf Anfrage

Taps for automatic lathes for
ISO Metric coarse thread DIN 13,
upon request

MF



DIN 13

Normal lang
Standard length

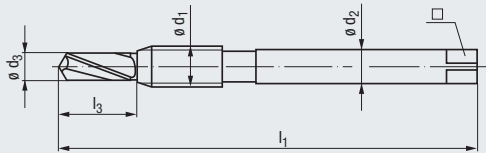

Technische Informationen Technical information	▶▶ 245 - 266	Toleranz · Tolerance Beschichtung · Coating Schneidstoff · Cutting material	ISO 2/6H HSSE C / 2-3 E / 0				

Gewindetiefe und Lochform Thread depth and hole type		max. 1 x d ₁ 					
---	--	-----------------------------	--	--	--	--	--

Einsatzgebiete – Material Applications – material	▶▶ 22	P 1.1-2.1 N 2.2					
--	-------	--------------------	--	--	--	--	--

Werkzeug-Ident · Tool ident

M	ø d ₁ mm	P mm	l ₁	l ₃	ø d ₂	□	ø d ₃	Dimens.- Ident	KOMBI Normal-Ig				
	4	x 0,5	66	10	4,5	3,4	3,55	.0210	○				
	5	x 0,5	75	12	6	4,9	4,55	.0218					
	6	x 0,75	81	14	6	4,9	5,31	.0229	○				
	8	x 0,75	93	20	6	4,9	7,31	.0250					
	8	x 1	93	20	6	4,9	7,05	.0251	○				
	10	x 1	99	22	7	5,5	9,05	.0276	○				
	10	x 1,25	99	22	7	5,5	8,8	.0277					
	12	x 1	106	25	9	7	11,05	.0301					
	12	x 1,5	106	25	9	7	10,55	.0303	○				
	14	x 1,5	114	28	11	9	12,55	.0331	○				
	16	x 1,5	123	32	12	9	14,55	.0359	○				
	18	x 1,5	132	36	14	11	16,55	.0390					
	20	x 1,5	132	36	16	12	18,55	.0422	○				

- Product Finder
- V_c
- M
- MF**
- UNC UN-8
- UNF UNEF
- G, Rp NPSM, NPSF
- NPT, NPTF Rc, W
- BSW, BSF
- Pg
- MJ UNJC, UNJF
- EG (ST) SELF-LOCK
- Tr, Tr-F Rd
- Zubehör Accessories
- Tech. Info



● = Lagerwerkzeug, siehe Preisliste · Stock tool, see price list
 ○ = Kurzfristig lieferbar, Preis auf Anfrage · Available on short notice, price upon inquiry

- Product Finder
- V_c
- M
- MF
- UNC**
UN-8
- UNF
UNEF
- G, Rp
NPSM, NPSF
- NPT, NPTF
Rc, W
- BSW, BSF
- Pg
- MJ
UNJC, UNJF
- EG (STI)
SELF-LOCK
- Tr, Tr-F
Rd
- Zubehör
Accessories
- Tech. Info

UNC

ASME B1.1



≈ DIN 371

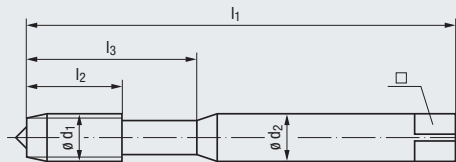

STEEL
Steel materials



Toleranz · Tolerance
Beschichtung · Coating
Schneidstoff · Cutting material

Technische Informationen
Technical information

» 245 - 266



2B	2B	3B	2B	2B
HSSE	HSSE	HSSE	HSSE	TIN
B / 4-5	B / 4-5	B / 4-5	R35	R35
E / O	E / O	E / O	E / O	E / O

Gewindetiefe und Lochform
Thread depth and hole type

max. 3 x d₁



max. 2,5 x d₁



Einsatzgebiete – Material
Applications – material

» 22

P 1.1-3.1 N 2.2	P 2.1-4.1	P 2.1-4.1	P 1.1-3.1 N 2.2	P 1.1-4.1 K 2.1 N 2.2
--------------------	-----------	-----------	--------------------	-----------------------------

Werkzeug-Ident · Tool ident

Nr.	Ø d ₁ inch	P Gg/1" (tpi)	l ₁	l ₂	l ₃	Ø d ₂	□	Dimens.- Ident	Rekord	Rekord	Rekord	Enorm	Enorm
									1B-STEEL-L	1B-STEEL-M	1B-STEEL-M „3B“	1-STEEL	1-STEEL TIN
Nr. 1	0.0730	64	45	7	–	2,8	2,1	1,55	.5000				
Nr. 2	0.0860	56	45	7	–	2,8	2,1	1,85	.5001	●	●	●	●
Nr. 3	0.0990	48	50	9	14	2,8	2,1	2,1	.5002	●	○	○	○
Nr. 4	0.1120	40	56	11	18	3,5	2,7	2,35	.5003	●	●	○	●
Nr. 5	0.1250	40	56	11	18	3,5	2,7	2,65	.5004	●	●	○	○
Nr. 6	0.1380	32	56	12	20	4	3	2,85	.5005	●	●	○	●
Nr. 8	0.1640	32	63	13	21	4,5	3,4	3,5	.5006	●	●	●	●
Nr. 10	0.1900	24	70	15	25	6	4,9	3,9	.5007	●	●	●	●
Nr. 12	0.2160	24	80	16	30	6	4,9	4,5	.5008	●	○	○	○
1/4	0.2500	20	80	17	30	7	5,5	5,1	.5009	●	●	●	●
5/16	0.3125	18	90	20	35	8	6,2	6,6	.5010	●	●	●	●
3/8	0.3750	16	100	22	39	10	8	8	.5011	●	●	●	●

≈ DIN 376

















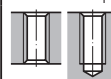

144

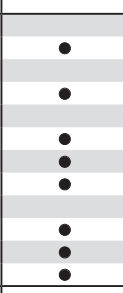
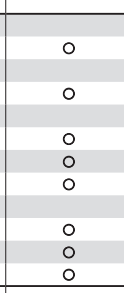
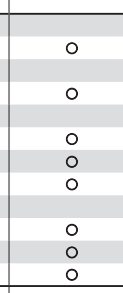
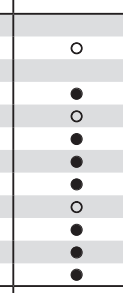
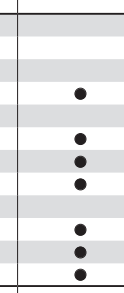
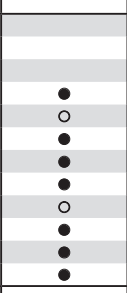
144

144

144

144

STEEL Steel materials 	VA Stainless steel materials 						H Materials of high tensile strength 
3B HSSE R35 C / 2-3 E / O	2B NT HSSE B / 4-5 E / O / P	2B TIN HSSE B / 4-5 E / O / P	2B GLT-1 HSSE B / 4-5 E / O / P	2B GLT-1 HSSE R35 C / 2-3 E / O / P	2B GLT-1 HSSE R35 C / 2-3 E / O / P	2BX NT HSSE C / 2-3 E / O / P	
max. 2,5 x d ₁ 	max. 3 x d ₁ 			max. 2,5 x d ₁ 		max. 2 x d ₁ 	
P 1.1-3.1 N 2.2	P 1.1-3.1 M 1.1-2.1 K 2.1 N 2.2, 2.5-6	P 1.1-4.1 M 1.1-3.1 K 2.1 N 2.2, 2.5-6	P 1.1-4.1 M 1.1-3.1 K 2.1 N 2.2	P 1.1-3.1 M 1.1-2.1 K 2.1	P 1.1-4.1 M 1.1-3.1 K 2.1	P 1.1-3.1 K 1.1-4.2 N 2.4-7 N 4.1, 5.1	
B0501010 Enorm 1-STEEL „3B“	B0203000 Rekord 1B-VA NT	B0203100 Rekord 1B-VA TIN	B020C300 Rekord 1B-VA GLT-1	B0503000 Enorm 1-VA	B050C300 Enorm 1-VA GLT-1	B0100501 Rekord 1A-H NT	
							
 145	 145	 145	 145	 145	 145	 145	

- Product Finder
- Vc
- M
- MF
- UNC UN-6
- UNF UNEF
- G, Rp NPSM, NPSF
- NPT, NPTF Rc, W
- BSW, BSF
- Pg
- MJ UNJC, UNJF
- EG (STI) SELF-LOCK
- Tr, Tr-F Rd
- Zubehör Accessories
- Tech. Info

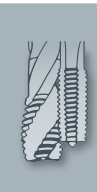

- Nr. 1 - 64
- Nr. 2 - 56
- Nr. 3 - 48
- Nr. 4 - 40
- Nr. 5 - 40
- Nr. 6 - 32
- Nr. 8 - 32
- Nr. 10 - 24
- Nr. 12 - 24
- 1/4 - 20
- 5/16 - 18
- 3/8 - 16



Gewindeschneidapparate
Typ SWITCH-MASTER®
siehe Seite 739 - 742

Tapping attachments
type SWITCH-MASTER®,
see page 739 - 742

● = Lagerwerkzeug, siehe Preisliste · Stock tool, see price list
○ = Kurzfristig lieferbar, Preis auf Anfrage · Available on short notice, price upon inquiry

- Product Finder
- Vc
- M
- MF
- UNC**
UN-8
- UNF
UNEF
- G, Rp
NPSM, NPSF
- NPT, NPTF
Rc, W
- BSW, BSF
- Pg
- MJ
UNJC, UNJF
- EG (STI)
SELF-LOCK
- Tr, Tr-F
Rd
- Zubehör
Accessories
- Tech. Info

UNC

ASME B1.1



≈ DIN 371

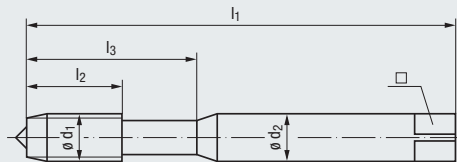

Z
CNC-controlled machines



Toleranz · Tolerance
Beschichtung · Coating
Schneidstoff · Cutting material

Technische Informationen
Technical information

» 245 - 266

2BX	2BX	2BX	2BX
TIN-60	GLT-1	TIN-60	GLT-1
HSSE-PM	HSSE-PM	HSSE-PM	HSSE-PM
R45	R45	R45	R45
C / 2-3	C / 2-3	E / 1,5-2	E / 1,5-2
E / O / P	E / O / P	E / O / P	E / O / P

Gewindetiefe und Lochform
Thread depth and hole type

max. 3 x d₁



Einsatzgebiete – Material
Applications – material

» 22

P 2.1-4.1	P 2.1-4.1	P 2.1-4.1	P 2.1-4.1
M 1.1-3.1	M 1.1-3.1	M 1.1-3.1	M 1.1-3.1
K 2.1	K 2.1	K 2.1	K 2.1
N 1.4-2.2, 2.4-5	N 1.4-2.2, 2.4-5	N 1.4-2.2, 2.4-5	N 1.4-2.2, 2.4-5
S 1.1	S 1.1	S 1.1	S 1.1

Werkzeug-Ident · Tool ident

B5760F01 B576A601 B5820F01 B582A601

Nr.	ø d ₁		P Gg/1" (tpi)	l ₁	l ₂	l ₃	ø d ₂	□	Dimens.-Ident	Enorm			
	inch	inch								1-Z-X-PM TIN-60	1-Z-X-PM GLT-1	1-Z/E-X-PM TIN-60	1-Z/E-X-PM GLT-1
Nr. 1	0.0730	64	45	4	–	2,8	2,1	1,55	.5000				
Nr. 2	0.0860	56	45	4,5	–	2,8	2,1	1,85	.5001				
Nr. 3	0.0990	48	50	5	14	2,8	2,1	2,1	.5002				
Nr. 4	0.1120	40	56	6	18	3,5	2,7	2,35	.5003	●	●	●	●
Nr. 5	0.1250	40	56	7	18	3,5	2,7	2,65	.5004	●	●	●	●
Nr. 6	0.1380	32	56	7	20	4	3	2,85	.5005	●	●	●	●
Nr. 8	0.1640	32	63	8	21	4,5	3,4	3,5	.5006	●	●	●	●
Nr. 10	0.1900	24	70	10	25	6	4,9	3,9	.5007	●	●	●	●
Nr. 12	0.2160	24	80	10	30	6	4,9	4,5	.5008	●	●	●	●
1/4	0.2500	20	80	13	30	7	5,5	5,1	.5009	●	●	●	●
5/16	0.3125	18	90	14	35	8	6,2	6,6	.5010	●	●	●	●
3/8	0.3750	16	100	16	39	10	8	8	.5011	●	●	●	●

≈ DIN 376



146

146

146

146

UNC

ASME B1.1



≈ DIN 371

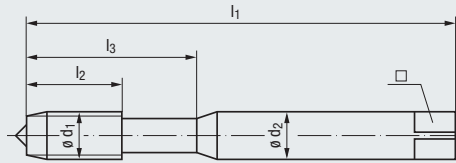

Technische Informationen
Technical information

» 245 - 266

Toleranz · Tolerance
Beschichtung · Coating
Schneidstoff · Cutting material



Gewindetiefe und Lochform
Thread depth and hole type

Einsatzgebiete – Material
Applications – material

» 22

Werkzeug-Ident · Tool ident

Nr.	Ø d ₁ inch	P Gg/1" (tpi)	l ₁	l ₂	l ₃	Ø d ₂	□	Ø	Dimens.- Ident	max. 3 x d ₁			
										Enorm 1-Z	Enorm 1-Z „+0,05“	Enorm 1-Z/E	Enorm 1-Z/E TIN
Nr. 1	0.0730	64	45	4	–	2,8	2,1	1,55	.5000				
Nr. 2	0.0860	56	45	4,5	–	2,8	2,1	1,85	.5001	●			
Nr. 3	0.0990	48	50	5	14	2,8	2,1	2,1	.5002		○	○	
Nr. 4	0.1120	40	56	6	18	3,5	2,7	2,35	.5003	●	○	●	●
Nr. 5	0.1250	40	56	7	18	3,5	2,7	2,65	.5004	○	○	○	
Nr. 6	0.1380	32	56	7	20	4	3	2,85	.5005	●	○	○	●
Nr. 8	0.1640	32	63	8	21	4,5	3,4	3,5	.5006	●	○	●	●
Nr. 10	0.1900	24	70	10	25	6	4,9	3,9	.5007	●	○	●	●
Nr. 12	0.2160	24	80	10	30	6	4,9	4,5	.5008	○	○	○	
1/4	0.2500	20	80	13	30	7	5,5	5,1	.5009	●	●	●	●
5/16	0.3125	18	90	14	35	8	6,2	6,6	.5010	●	●	●	●
3/8	0.3750	16	100	16	39	10	8	8	.5011	●	●	●	●

≈ DIN 376



147

147

147

147

1) Vorbohrdurchmesser für Gewindebohrer mit Übermaß um 0,05 mm anheben
Increase drill diameter for taps with oversize by 0.05 mm

- Product Finder
- V_c
- M
- MF
- UNC**
UN-6
- UNF
UNEF
- G, Rp
NPSM, NPSF
- NPT, NPTF
Rc, W
- BSW, BSF
- Pg
- MJ
UNJC, UNJF
- EG (STI)
SELF-LOCK
- Tr, Tr-F
Rd
- Zubehör
Accessories
- Tech. Info



- Product Finder
- Vc
- M
- MF
- UNC
UN-8
- UNF
UNEF
- G, Rp
NPSM, NPSF
- NPT, NPTF
Rc, W
- BSW, BSF
- Pg
- MJ
UNJC, UNJF
- EG (STI)
SELF-LOCK
- Tr, Tr-F
Rd
- Zubehör
Accessories
- Tech. Info

UNC

ASME B1.1



≈ DIN 376

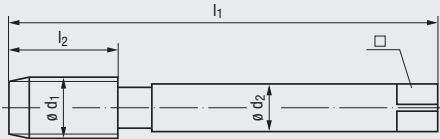

STEEL
Steel materials



Toleranz · Tolerance
Beschichtung · Coating
Schneidstoff · Cutting material

Technische Informationen
Technical information

» 245 - 266



2B	2B	3B	2B	2B
HSSE	HSSE	HSSE	HSSE	TIN
B / 4-5	B / 4-5	B / 4-5	R35	R35
E / O	E / O	E / O	E / O	E / O

Gewindetiefe und Lochform
Thread depth and hole type

max. 3 x d₁



max. 2,5 x d₁



Einsatzgebiete – Material
Applications – material

» 22

P 1.1-3.1 N 2.2	P 2.1-4.1	P 2.1-4.1	P 1.1-3.1 N 2.2	P 1.1-4.1 K 2.1 N 2.2
--------------------	-----------	-----------	--------------------	-----------------------------

Werkzeug-Ident · Tool ident

C0208900	C0201000	C0201010	C0501000	C0501400
----------	----------	----------	----------	----------

Ø d ₁ inch	inch	P Gg/1" (tpi)	l ₁	l ₂	Ø d ₂	□		Dimens.- Ident	Rekord	Rekord	Rekord	Enorm	Enorm
									2B-STEEL-L	2B-STEEL-M	2B-STEEL-M „3B“	2-STEEL	2-STEEL TIN
1/4	0.2500	20	80	17	4,5	3,4	5,1	.5009	●	●	●	●	
5/16	0.3125	18	90	20	6	4,9	6,6	.5010	●	●	●	●	
3/8	0.3750	16	100	22	7	5,5	8	.5011	●	●	○	●	
7/16	0.4375	14	100	22	8	6,2	9,4	.5012	●	●	●	●	●
1/2	0.5000	13	110	25	9	7	10,8	.5013	●	●	●	●	●
9/16	0.5625	12	110	26	11	9	12,2	.5014	●	○	○	●	○
5/8	0.6250	11	110	27	12	9	13,5	.5015	●	●	●	●	●
3/4	0.7500	10	125	30	14	11	16,5	.5016	●	●	●	●	●
7/8	0.8750	9	140	32	18	14,5	19,5	.5017	●	●	●	●	●
1"	1.0000	8	160	36	18	14,5	22,25	.5018	●	●	●	●	●
1 1/8	1.1250	7	180	40	22	18	25	.5019	●	○	●	●	●
1 1/4	1.2500	7	180	40	22	18	28	.5020	●	●	●	●	●
1 3/8	1.3750	6	200	50	28	22	30,75	.5021	●	○	●	●	●
1 1/2	1.5000	6	200	50	28	22	34	.5022	●	●	●	●	●
1 3/4	1.7500	5	220	58	36	29	39,5	.5023	●	●	●	●	●
2"	2.0000	4 1/2	250	65	40	32	45	.5024	●	●	●	●	●

≈ DIN 371



» 140

» 140

» 140

» 140

» 140



Gewinde-Tiefenlehndorne
siehe Seite 624 - 627

Thread depth plug gauges,
see page 624 - 627

- Product Finder
- Vc
- M
- MF
- UNC**
UN-8
- UNF
UNEF
- G, Rp
NPSM, NPSF
- NPT, NPTF
Rc, W
- BSW, BSF
- Pg
- MJ
UNJC, UNJF
- EG (STI)
SELF-LOCK
- Tr, Tr-F
Rd
- Zubehör
Accessories
- Tech. Info

UNC

ASME B1.1

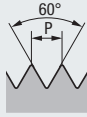

≈ DIN 376

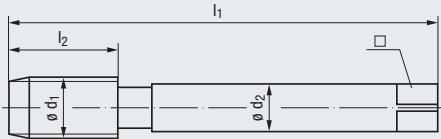

Z
CNC-controlled machines



Toleranz · Tolerance
Beschichtung · Coating
Schneidstoff · Cutting material

Technische Informationen
Technical information

» 245 - 266



2BX	2BX	2BX	2BX
TIN-60	GLT-1	TIN-60	GLT-1
HSSE-PM	HSSE-PM	HSSE-PM	HSSE-PM
R45	R45	R45	R45
C / 2-3	C / 2-3	E / 1,5-2	E / 1,5-2
E / O / P	E / O / P	E / O / P	E / O / P

Gewindetiefe und Lochform
Thread depth and hole type

max. 3 x d₁



Einsatzgebiete – Material
Applications – material

» 22

P 2.1-4.1	P 2.1-4.1	P 2.1-4.1	P 2.1-4.1
M 1.1-3.1	M 1.1-3.1	M 1.1-3.1	M 1.1-3.1
K 2.1	K 2.1	K 2.1	K 2.1
N 1.4-2.2, 2.4-5	N 1.4-2.2, 2.4-5	N 1.4-2.2, 2.4-5	N 1.4-2.2, 2.4-5
S 1.1	S 1.1	S 1.1	S 1.1

Werkzeug-Ident · Tool ident

C5760F01 C576A601 C5820F01 C582A601

Ø d ₁ inch	P inch	P Gg/1" (tpi)	l ₁	l ₂	Ø d ₂	□		Dimens.- Ident	Enorm	Enorm	Enorm	Enorm
									2-Z-X-PM TIN-60	2-Z-X-PM GLT-1	2-Z/E-X-PM TIN-60	2-Z/E-X-PM GLT-1
1/4	0.2500	20	80	13	4,5	3,4	5,1	.5009				
5/16	0.3125	18	90	14	6	4,9	6,6	.5010				
3/8	0.3750	16	100	16	7	5,5	8	.5011				
7/16	0.4375	14	100	18	8	6,2	9,4	.5012	●	●	●	●
1/2	0.5000	13	110	20	9	7	10,8	.5013	●	●	●	●
9/16	0.5625	12	110	20	11	9	12,2	.5014				
5/8	0.6250	11	110	22	12	9	13,5	.5015	●	●	●	●
3/4	0.7500	10	125	25	14	11	16,5	.5016	●	●	●	●
7/8	0.8750	9	140	27	18	14,5	19,5	.5017				
1"	1.0000	8	160	30	18	14,5	22,25	.5018	●	●	●	●
1 1/8	1.1250	7	180	35	22	18	25	.5019				
1 1/4	1.2500	7	180	35	22	18	28	.5020				
1 3/8	1.3750	6	200	40	28	22	30,75	.5021				
1 1/2	1.5000	6	200	40	28	22	34	.5022				
1 3/4	1.7500	5	220	45	36	29	39,5	.5023				
2"	2.0000	4 1/2	250	50	40	32	45	.5024				

≈ DIN 371



» 142

» 142

» 142

» 142

UNC

ASME B1.1



≈ DIN 376

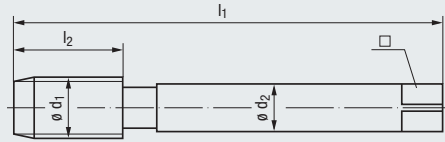

Technische Informationen
Technical information

» 245 - 266

Toleranz · Tolerance
Beschichtung · Coating
Schneidstoff · Cutting material



Gewindetiefe und Lochform
Thread depth and hole type

Einsatzgebiete – Material
Applications – material

» 22

Werkzeug-Ident · Tool ident

Ø d ₁ inch	P inch	Gg/1" (tpi)	l ₁	l ₂	Ø d ₂	□	Dimens.- Ident	max. 3 x d ₁			
								Enorm 2-Z	Enorm 2-Z „+0,05“	Enorm 2-Z/E	Enorm 2-Z/E TIN
1/4	0.2500	20	80	13	4,5	3,4	.5009				
5/16	0.3125	18	90	14	6	4,9	.5010				
3/8	0.3750	16	100	16	7	5,5	.5011	○			
7/16	0.4375	14	100	18	8	6,2	.5012	●	○	●	●
1/2	0.5000	13	110	20	9	7	.5013	●	○	●	●
9/16	0.5625	12	110	20	11	9	.5014	○	○	○	○
5/8	0.6250	11	110	22	12	9	.5015	●	○	●	●
3/4	0.7500	10	125	25	14	11	.5016	●	○	●	●
7/8	0.8750	9	140	27	18	14,5	.5017	○	○	○	○
1"	1.0000	8	160	30	18	14,5	.5018	●	○	●	●
1 1/8	1.1250	7	180	35	22	18	.5019				
1 1/4	1.2500	7	180	35	22	18	.5020				
1 3/8	1.3750	6	200	40	28	22	.5021				
1 1/2	1.5000	6	200	40	28	22	.5022				
1 3/4	1.7500	5	220	45	36	29	.5023				
2"	2.0000	4 1/2	250	50	40	32	.5024				

≈ DIN 371



» 143

» 143

» 143

» 143

1) Vorbohrdurchmesser für Gewindebohrer mit Übermaß um 0,05 mm anheben
Increase drill diameter for taps with oversize by 0.05 mm

- Product Finder
- V_c
- M
- MF
- UNC UN-6
- UNF UNEF
- G, Rp NPSM, NPSF
- NPT, NPTF Rc, W
- BSW, BSF
- Pg
- MJ UNJC, UNJF
- EG (ST) SELF-LOCK
- Tr, Tr-F Rd
- Zubehör Accessories
- Tech. Info



- Product Finder
- Vc
- M
- MF
- UNC
UN-8
- UNF
UNEF
- G, Rp
NPSM, NPSF
- NPT, NPTF
Rc, W
- BSW, BSF
- Pg
- MJ
UNJC, UNJF
- EG (STI)
SELF-LOCK
- Tr, Tr-F
Rd
- Zubehör
Accessories
- Tech. Info

UN-8

ASME B1.1



≈ DIN
374

VA
Stainless steel
materials

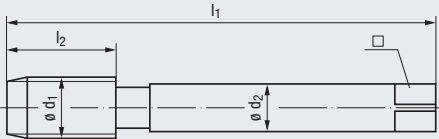

Technische Informationen
Technical information

» 245 - 266

Toleranz · Tolerance
Beschichtung · Coating
Schneidstoff · Cutting material



- 2B
- HSSE
- R35
- C / 2-3
- E / O / P

Gewindetiefe und Lochform
Thread depth and hole type

max. 2,5 x d₁



Einsatzgebiete – Material
Applications – material

» 22

- P 1.1-3.1
- M 1.1-2.1
- K 2.1

Werkzeug-Ident · Tool ident

C0503000

ø d ₁ inch	inch	P Gg/1" (tpi)	l ₁	l ₂	ø d ₂	□		Dimens.- Ident	Enorm 2-VA				
1 1/8	1.1250	8	180	30	22	18	25,4	.5247	●				
1 1/4	1.2500	8	180	30	22	18	28,6	.5249	●				
1 3/8	1.3750	8	200	30	28	22	31,8	.5251	●				
1 1/2	1.5000	8	200	30	28	22	35	.5253	●				
1 5/8	1.6250	8	200	30	32	24	38,1	.5255	●				
1 3/4	1.7500	8	200	30	36	29	41,3	.5257	●				
1 7/8	1.8750	8	225	33	36	29	44,5	.5259	○				
2"	2.0000	8	225	33	40	32	47,7	.5261	●				

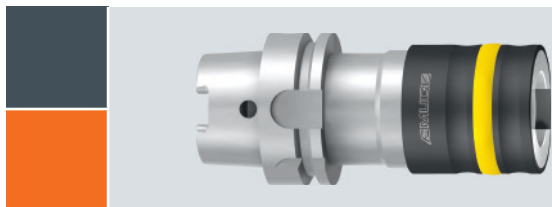

Schnellwechsel-Aufnahmen Typ KSN
siehe Seite 688 - 697

Quick-change tap holders type KSN,
see page 688 - 697

UNC

ASME B1.1



≈ DIN 352

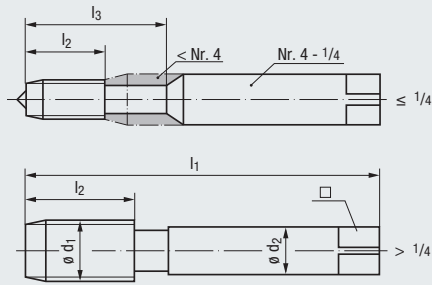

Technische Informationen
Technical information

» 245 - 266

Toleranz · Tolerance
Beschichtung · Coating
Schneidstoff · Cutting material



HSSE

HSSE

2BX

2BX

A / 5-6

D / 3-4

C / 2-3

C / 2-3

O / P

O / P

O / P

O / P

Gewindetiefe und Lochform
Thread depth and hole type

max. 2 x d₁

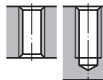

Einsatzgebiete – Material
Applications – material

» 22

P 1.1-3.1

P 1.1-3.1

P 1.1-3.1

P 1.1-3.1

Werkzeug-Ident · Tool ident

H0111019

H0111029

H0111001

H0101001

Nr.	Ø d ₁ inch	P Gg/1" (tpi)	l ₁	l ₂	l ₃	Ø d ₂	□	Dimens.- Ident	HGB-Set				
									V-Nr.1	M-Nr.2	F	3S (Nr.1, Nr.2, F)	
Nr. 1	0.0730	64	36	8	—	2,8	2,1	1,55	.5000	○	○	○	○
Nr. 2	0.0860	56	36	9	—	2,8	2,1	1,85	.5001	○	○	○	○
Nr. 3	0.0990	48	40	9	—	2,8	2,1	2,1	.5002	○	○	○	○
Nr. 4	0.1120	40	40	10	18	3,5	2,7	2,35	.5003	●	●	●	●
Nr. 5	0.1250	40	40	10	18	3,5	2,7	2,65	.5004	●	●	●	●
Nr. 6	0.1380	32	45	11	20	4	3	2,85	.5005	●	●	●	●
Nr. 8	0.1640	32	45	12	22	4,5	3,4	3,5	.5006	●	●	●	●
Nr. 10	0.1900	24	50	14	25	6	4,9	3,9	.5007	●	●	●	●
Nr. 12	0.2160	24	56	16	28	6	4,9	4,5	.5008	●	●	●	●
1/4	0.2500	20	56	16	28	6	4,9	5,1	.5009	●	●	●	●
5/16	0.3125	18	63	20	—	6	4,9	6,6	.5010	○	○	○	○
3/8	0.3750	16	70	22	—	7	5,5	8	.5011	○	○	○	○
7/16	0.4375	14	70	22	—	8	6,2	9,4	.5012	○	○	○	○
1/2	0.5000	13	75	25	—	9	7	10,8	.5013	○	○	○	○
9/16	0.5625	12	80	26	—	11	9	12,2	.5014	○	○	○	○
5/8	0.6250	11	80	27	—	12	9	13,5	.5015	○	○	○	○
3/4	0.7500	10	95	32	—	14	11	16,5	.5016	○	○	○	○
7/8	0.8750	9	100	32	—	18	14,5	19,5	.5017	○	○	○	○
1"	1.0000	8	110	36	—	18	14,5	22,25	.5018	○	○	○	○
1 1/8	1.1250	7	125	40	—	22	18	25	.5019	○	○	○	○
1 1/4	1.2500	7	125	40	—	22	18	28	.5020	○	○	○	○
1 3/8	1.3750	6	150	50	—	28	22	30,75	.5021	○	○	○	○
1 1/2	1.5000	6	150	50	—	28	22	34	.5022	○	○	○	○
1 3/4	1.7500	5	160	58	—	36	29	39,5	.5023	○	○	○	○
2"	2.0000	4 1/2	180	65	—	40	32	45	.5024	○	○	○	○

- Product Finder
- Vc
- M
- MF
- UNC UN-6
- UNEF
- G, Rp NPSM, NPSF
- NPT, NPTF Rc, W
- BSW, BSF
- Pg
- MJ UNJC, UNJF
- EG (ST) SELF-LOCK
- Tr, Tr-F Rd
- Zubehör Accessories
- Tech. Info

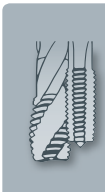

- Product Finder
- V_c
- M
- MF
- UNC**
UN-8
- UNF
UNEF
- G, Rp
NPSM, NPSF
- NPT, NPTF
Rc, W
- BSW, BSF
- Pg
- MJ
UNJC, UNJF
- EG (STI)
SELF-LOCK
- Tr, Tr-F
Rd
- Zubehör
Accessories
- Tech. Info

UNC



≈ DIN 352

ASME B1.1

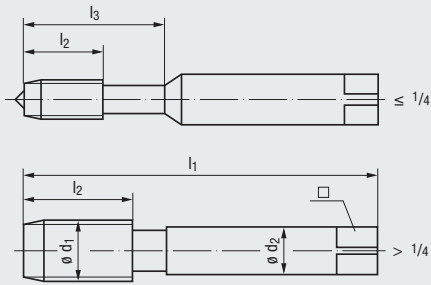

Toleranz · Tolerance
Beschichtung · Coating
Schneidstoff · Cutting material

Technische Informationen
Technical information

» 245 - 266



HSSE
C / 2-3
O / P

HSSE
C / 2-3
O / P

HSSE
C / 2-3
O / P

2BX
HSSE
C / 2-3
O / P

Gewindetiefe und Lochform
Thread depth and hole type

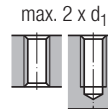

Einsatzgebiete – Material
Applications – material

» 22

P 1.1-5.1	P 1.1-5.1	P 1.1-5.1	P 1.1-5.1
M 1.1-4.1	M 1.1-4.1	M 1.1-4.1	M 1.1-4.1
S 2.1-2, 2.4	S 2.1-2, 2.4	S 2.1-2, 2.4	S 2.1-2, 2.4

Werkzeug-Ident · Tool ident

										H0413019	H0423019	H0423029	H0423001
										WM-Set V-Nr.1Z	WM-Set V-Nr.1	WM-Set M-Nr.2	WM-Set F
$\varnothing d_1$ inch	P inch	P Gg/1" (tpi)	l_1	l_2	l_3	$\varnothing d_2$	\square		Dimens.-Ident				
1/4	0.2500	20	56	16	28	6	4,9	5,1	.5009	●	●	●	●
5/16	0.3125	18	63	20	–	6	4,9	6,6	.5010	●	●	●	●
3/8	0.3750	16	70	22	–	7	5,5	8	.5011	●	●	●	●
7/16	0.4375	14	70	22	–	8	6,2	9,4	.5012	○	○	○	○
1/2	0.5000	13	75	25	–	9	7	10,8	.5013	●	●	●	●
9/16	0.5625	12	80	26	–	11	9	12,2	.5014	○	○	○	○
5/8	0.6250	11	80	27	–	12	9	13,5	.5015	○	○	○	○
3/4	0.7500	10	95	32	–	14	11	16,5	.5016	○	○	○	○
7/8	0.8750	9	100	32	–	18	14,5	19,5	.5017	○	○	○	○
1"	1.0000	8	110	36	–	18	14,5	22,25	.5018	○	○	○	○

1) Der Vorschneider Nr.1Z mit Führungszapfen ist eine zusätzliche Hilfe zum winkelrechten Anschneiden von Hand. Er kann z.B. auf der Maschine weggelassen werden. Die Profilabstufung von Nr.1Z und Nr.1 ist gleich.
The taper tap No. 1Z with cylindrical pilot is an additional aid for true alignment especially when tapping by hand. It can be deleted when tapping by machine. The profile graduation of No.1Z, and No.1 is the same.

Product Finder

V_c

M

MF

UNC
UN-8

UNF
UNEF

G, Rp
NPSM, NPSF

NPT, NPTF
Rc, W

BSW, BSF

Pg

MJ
UNJC, UNJF



EG (STI)
SELF-LOCK

Tr, Tr-F
Rd

Zubehör
Accessories

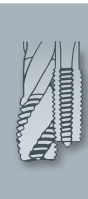
Tech. Info



 2)		 2)	
2BX	2BX	2BX	2BX
HSSE	HSSE	HSSE	HSSE
C / 2-3	C / 2-3	C / 2-3	C / 2-3
O / P	O / P	O / P	O / P

max. 2 x d₁

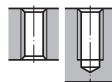

P 1.1-5.1	P 1.1-5.1	P 1.1-5.1	P 1.1-5.1
M 1.1-4.1	M 1.1-4.1	M 1.1-4.1	M 1.1-4.1
S 2.1-2, 2.4	S 2.1-2, 2.4	S 2.1-2, 2.4	S 2.1-2, 2.4

H0453001	H0483001	H0403001	H0433001
WM-Set 3S	WM-Set 2S	WM-Set 4S	WM-Set 3S
(Nr.1Z, Nr.1, F)	(Nr.1, F)	(Nr.1Z, Nr.1, Nr.2, F)	(Nr.1, Nr.2, F)
●	●	●	●
●	●	●	●
●	●	●	●
○	○	○	○
●	●	●	●
○	○	○	○
○	○	○	○
○	○	○	○

1/4 - 20
5/16 - 18
3/8 - 16
7/16 - 14
1/2 - 13
9/16 - 12
5/8 - 11
3/4 - 10
7/8 - 9
1" - 8

2) Beim Gewindebohren von Hand in Durchgangslöcher entfällt Nr.1
No.1 is not needed when tapping in through holes by hand

- Product Finder
- V_c
- M
- MF
- UNC UN-8
- UNF UNEF
- G, Rp NPSM, NPSF
- NPT, NPTF Rc, W
- BSW, BSF
- Pg
- MJ UNJC, UNJF
- EG (STI) SELF-LOCK
- Tr, Tr-F Rd
- Zubehör Accessories
- Tech. Info

UNF

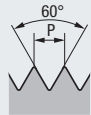

ASME B1.1

≈ DIN 371

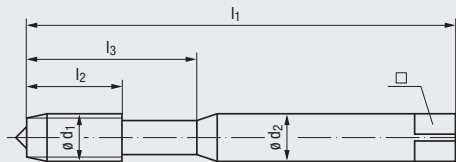

STEEL
Steel materials



Toleranz · Tolerance
Beschichtung · Coating
Schneidstoff · Cutting material

Technische Informationen
Technical information

» 245 - 266

2B	2B	3B	2B	2B
HSSE	HSSE	HSSE	HSSE	TIN
B / 4-5	B / 4-5	B / 4-5	R35	R35
E / O	E / O	E / O	E / O	E / O

Gewindetiefe und Lochform
Thread depth and hole type



Einsatzgebiete – Material
Applications – material

» 22

P 1.1-3.1 N 2.2	P 2.1-4.1	P 2.1-4.1	P 1.1-3.1 N 2.2	P 1.1-4.1 K 2.1 N 2.2
--------------------	-----------	-----------	--------------------	-----------------------------

Werkzeug-Ident · Tool ident















B0208900 B0201000 B0201010 B0501000 B0501400

Nr.	d ₁ inch	P Gg/1" (tpi)	l ₁	l ₂	l ₃	d ₂	□	Image	Dimens.-Ident	Rekord 1B-STEEL-L	Rekord 1B-STEEL-M	Rekord 1B-STEEL-M „3B“	Enorm 1-STEEL	Enorm 1-STEEL TIN
										●	●	●	○	●
Nr. 2	0.0860	64	45	7	12	2,8	2,1	1,85	.5035	●	●	●	○	
Nr. 3	0.0990	56	50	9	14	2,8	2,1	2,15	.5036	●	○	●	○	
Nr. 4	0.1120	48	56	11	18	3,5	2,7	2,4	.5037	●	●	●	○	
Nr. 5	0.1250	44	56	11	18	3,5	2,7	2,7	.5038	●	○	●	○	
Nr. 6	0.1380	40	56	12	20	4	3	2,95	.5039	●	●	●	●	●
Nr. 8	0.1640	36	63	13	21	4,5	3,4	3,5	.5040	●	●	●	●	●
Nr. 10	0.1900	32	70	15	25	6	4,9	4,1	.5041	●	●	●	●	●
Nr. 12	0.2160	28	80	16	30	6	4,9	4,6	.5042	●	●	●	○	
1/4	0.2500	28	80	17	30	7	5,5	5,5	.5043	●	●	●	●	●
5/16	0.3125	24	90	17	35	8	6,2	6,9	.5044	●	●	●	●	●
3/8	0.3750	24	90	18	35	10	8	8,5	.5045	●	●	●	●	●

≈ DIN 374



156 156 156 156 156

STEEL Steel materials 	VA Stainless steel materials 						H Materials of high tensile strength 
3B HSSE R35 C / 2-3 E / O	2B NT HSSE B / 4-5 E / O / P	2B TIN HSSE B / 4-5 E / O / P	2B GLT-1 HSSE B / 4-5 E / O / P	2B GLT-1 HSSE R35 C / 2-3 E / O / P	2B GLT-1 HSSE R35 C / 2-3 E / O / P	2BX NT HSSE C / 2-3 E / O / P	
max. 2,5 x d ₁ 	max. 3 x d ₁ 			max. 2,5 x d ₁ 		max. 2 x d ₁ 	
P 1.1-3.1 N 2.2	P 1.1-3.1 M 1.1-2.1 K 2.1 N 2.2, 2.5-6	P 1.1-4.1 M 1.1-3.1 K 2.1 N 2.2, 2.5-6	P 1.1-4.1 M 1.1-3.1 K 2.1 N 2.2	P 1.1-3.1 M 1.1-2.1 K 2.1	P 1.1-4.1 M 1.1-3.1 K 2.1	P 1.1-3.1 K 1.1-4.2 N 2.4-7 N 4.1, 5.1	
B0501010 Enorm 1-STEEL „3B“	B0203000 Rekord 1B-VA NT	B0203100 Rekord 1B-VA TIN	B020C300 Rekord 1B-VA GLT-1	B0503000 Enorm 1-VA	B050C300 Enorm 1-VA GLT-1	B0100501 Rekord 1A-H NT	
● ● ● ● ○ ● ● ●	● ● ● ● ● ● ● ●	○ ○ ○ ○ ○ ○ ○ ○	○ ○ ○ ○ ○ ○ ○ ○	● ○ ● ● ● ● ● ●	● ○ ● ● ● ● ● ●	○ ○ ● ● ● ● ● ●	
 157	 157	 157	 157	 157	 157	 157	

- Product Finder
- Vc
- M
- MF
- UNC UN-8
- UNF UNEF
- G, Rp NPSM, NPSF
- NPT, NPTF Rc, W
- BSW, BSF
- Pg
- MJ UNJC, UNJF
- EG (STI) SELF-LOCK
- Tr, Tr-F Rd
- Zubehör Accessories
- Tech. Info



- Nr. 2 - 64
- Nr. 3 - 56
- Nr. 4 - 48
- Nr. 5 - 44
- Nr. 6 - 40
- Nr. 8 - 36
- Nr. 10 - 32
- Nr. 12 - 28
- 1/4 - 28
- 5/16 - 24
- 3/8 - 24

● = Lagerwerkzeug, siehe Preisliste · Stock tool, see price list
○ = Kurzfristig lieferbar, Preis auf Anfrage · Available on short notice, price upon inquiry

- Product Finder
- Vc
- M
- MF
- UNC
UN-8
- UNF
UNEF
- G, Rp
NPSM, NPSF
- NPT, NPTF
Rc, W
- BSW, BSF
- Pg
- MJ
UNJC, UNJF
- EG (STI)
SELF-LOCK
- Tr, Tr-F
Rd
- Zubehör
Accessories
- Tech. Info



UNF

ASME B1.1

≈ DIN 371

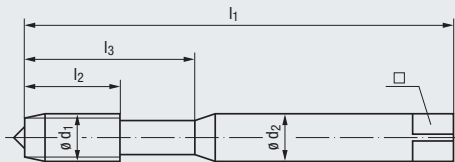

Z
CNC-controlled machines



Toleranz · Tolerance
Beschichtung · Coating
Schneidstoff · Cutting material

Technische Informationen
Technical information

» 245 - 266

2BX	2BX	2BX	2BX
TIN-60	GLT-1	TIN-60	GLT-1
HSSE-PM	HSSE-PM	HSSE-PM	HSSE-PM
R45	R45	R45	R45
C / 2-3	C / 2-3	E / 1,5-2	E / 1,5-2
E / O / P	E / O / P	E / O / P	E / O / P

Gewindetiefe und Lochform
Thread depth and hole type

max. 3 x d₁



Einsatzgebiete – Material
Applications – material

» 22

P 2.1-4.1	P 2.1-4.1	P 2.1-4.1	P 2.1-4.1
M 1.1-3.1	M 1.1-3.1	M 1.1-3.1	M 1.1-3.1
K 2.1	K 2.1	K 2.1	K 2.1
N 1.4-2.2, 2.4-5	N 1.4-2.2, 2.4-5	N 1.4-2.2, 2.4-5	N 1.4-2.2, 2.4-5
S 1.1	S 1.1	S 1.1	S 1.1

Werkzeug-Ident · Tool ident

B5760F01 B576A601 B5820F01 B582A601

Nr.	d ₁ inch	P inch	P Gg/1" (tpi)	l ₁	l ₂	l ₃	d ₂	□	Dimens.- Ident	Enorm			
										1-Z-X-PM TIN-60	1-Z-X-PM GLT-1	1-Z/E-X-PM TIN-60	1-Z/E-X-PM GLT-1
Nr. 2	0.0860	64	45	4,5	12	2,8	2,1	1,85	.5035				
Nr. 3	0.0990	56	50	5	14	2,8	2,1	2,15	.5036				
Nr. 4	0.1120	48	56	6	18	3,5	2,7	2,4	.5037				
Nr. 5	0.1250	44	56	7	18	3,5	2,7	2,7	.5038				
Nr. 6	0.1380	40	56	7	20	4	3	2,95	.5039				
Nr. 8	0.1640	36	63	8	21	4,5	3,4	3,5	.5040				
Nr. 10	0.1900	32	70	10	25	6	4,9	4,1	.5041	●	●	●	●
Nr. 12	0.2160	28	80	10	30	6	4,9	4,6	.5042	●	●	●	●
1/4	0.2500	28	80	10	30	7	5,5	5,5	.5043	●	●	●	●
5/16	0.3125	24	90	10	35	8	6,2	6,9	.5044	●	●	●	●
3/8	0.3750	24	90	10	35	10	8	8,5	.5045	●	●	●	●

≈ DIN 374



158

158

158

158

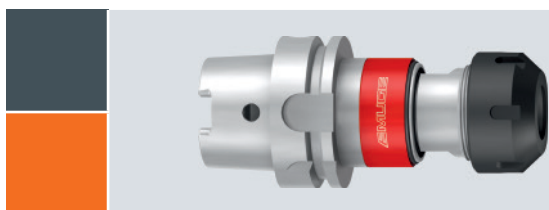

Werkzeug-Aufnahmen der Typenreihe
Softsynchro® siehe Seite 661 - 681

Tool holders of our Softsynchro® series,
see page 661 - 681

UNF

ASME B1.1

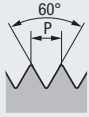

≈ DIN 371

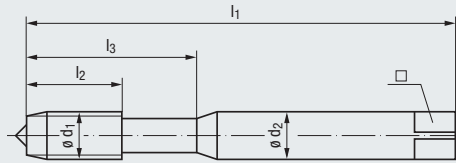

Technische Informationen
Technical information

» 245 - 266

Toleranz · Tolerance
Beschichtung · Coating
Schneidstoff · Cutting material



Gewindetiefe und Lochform
Thread depth and hole type

Einsatzgebiete – Material
Applications – material

» 22

Werkzeug-Ident · Tool ident

Nr.	Ø d ₁ inch	P inch	Gg/1" (tpi)	l ₁	l ₂	l ₃	Ø d ₂	□	Ø	Dimens.-Ident	Enorm 1-Z/E		
											Enorm 1-Z/E	Enorm 1-Z/E TIN	Enorm 1-Z/E „+0,05“
Nr. 2	0.0860	64	45	4,5	12	2,8	2,1	1,85	.5035	○	○	○	
Nr. 3	0.0990	56	50	5	14	2,8	2,1	2,15	.5036	○	○	○	
Nr. 4	0.1120	48	56	6	18	3,5	2,7	2,4	.5037	○	○	○	
Nr. 5	0.1250	44	56	7	18	3,5	2,7	2,7	.5038	○	○	○	
Nr. 6	0.1380	40	56	7	20	4	3	2,95	.5039	●	●	●	
Nr. 8	0.1640	36	63	8	21	4,5	3,4	3,5	.5040	●	●	●	
Nr. 10	0.1900	32	70	10	25	6	4,9	4,1	.5041	●	●	●	
Nr. 12	0.2160	28	80	10	30	6	4,9	4,6	.5042	○	○	○	
1/4	0.2500	28	80	10	30	7	5,5	5,5	.5043	●	●	●	
5/16	0.3125	24	90	10	35	8	6,2	6,9	.5044	●	●	●	
3/8	0.3750	24	90	10	35	10	8	8,5	.5045	●	●	●	

≈ DIN 374



» 159

» 159

» 159



2B	2B	2B +0,05 1)
HSSE	TIN	HSSE
R45	R45	R45
E / 1,5-2	E / 1,5-2	E / 1,5-2
E / O / P	E / O / P	E / O / P

max. 3 x d₁



P 1.1-4.1	P 1.1-4.1	P 1.1-4.1
M 1.1-2.1	M 1.1-3.1	M 1.1-2.1
N 2.1	N 1.4-6	N 2.1
	N 2.1-2, 2.4-5	
	S 1.1	

1) Vorbohrdurchmesser für Gewindebohrer mit Übermaß um 0,05 mm anheben
Increase drill diameter for taps with oversize by 0.05 mm

Product Finder

V_c

M

MF

UNC UN-8

UNF UNEF

G, Rp NPSM, NPSF

NPT, NPTF Rc, W

BSW, BSF

Pg

MJ UNJC, UNJF

EG (STI) SELF-LOCK

Tr, Tr-F Rd

Zubehör Accessories

Tech. Info



- Product Finder
- Vc
- M
- MF
- UNC UN-8
- UNF UNEF
- G, Rp NPSM, NPSF
- NPT, NPTF Rc, W
- BSW, BSF
- Pg
- MJ UNJC, UNJF
- EG (STI) SELF-LOCK
- Tr, Tr-F Rd
- Zubehör Accessories
- Tech. Info

UNF



ASME B1.1

≈ DIN 374

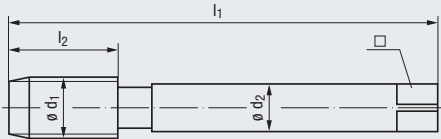

STEEL
Steel materials

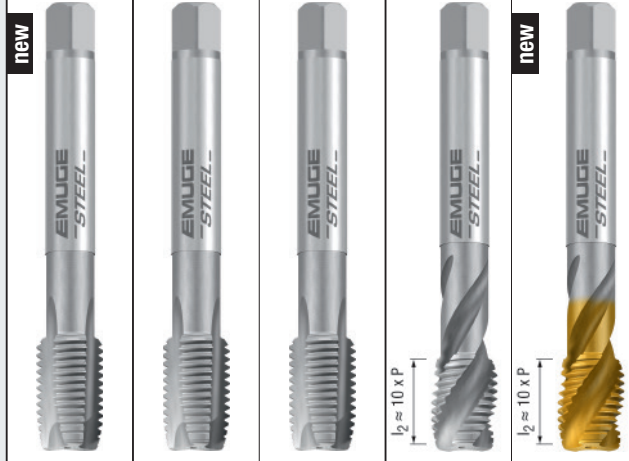

Toleranz · Tolerance
Beschichtung · Coating
Schneidstoff · Cutting material

Technische Informationen
Technical information

» 245 - 266



2B	2B	3B	2B	2B
HSSE	HSSE	HSSE	HSSE	TIN
B / 4-5	B / 4-5	B / 4-5	R35	R35
E / O	E / O	E / O	E / O	E / O

Gewindetiefe und Lochform
Thread depth and hole type

max. 3 x d₁



max. 2,5 x d₁



Einsatzgebiete – Material
Applications – material

» 22

P 1.1-3.1 N 2.2	P 2.1-4.1	P 2.1-4.1	P 1.1-3.1 N 2.2	P 1.1-4.1 K 2.1 N 2.2
--------------------	-----------	-----------	--------------------	-----------------------------

Werkzeug-Ident · Tool ident

C0208900	C0201000	C0201010	C0501000	C0501400
----------	----------	----------	----------	----------

Ø d ₁ inch	P inch	Gg/1" (tpi)	l ₁	l ₂	Ø d ₂	□	Dimens.- Ident	Rekord	Rekord	Rekord	Enorm	Enorm
								2B-STEEL-L	2B-STEEL-M	2B-STEEL-M „3B“	2-STEEL	2-STEEL TIN
1/4	0.2500	28	80	17	4,5	3,4	.5043	●	●	●	●	●
5/16	0.3125	24	90	17	6	4,9	.5044	●	●	●	●	●
3/8	0.3750	24	90	18	7	5,5	.5045	●	●	○	●	●
7/16	0.4375	20	100	22	8	6,2	.5046	●	●	●	●	●
1/2	0.5000	20	100	22	9	7	.5047	●	●	●	●	●
9/16	0.5625	18	100	22	11	9	.5048	●	○	○	●	○
5/8	0.6250	18	100	22	12	9	.5049	●	●	●	●	●
3/4	0.7500	16	110	25	14	11	.5050	●	●	●	●	●
7/8	0.8750	14	125	25	18	14,5	.5051	●	●	●	●	●
1"	1.0000	12	140	28	18	14,5	.5052	●	●	●	●	●
1 1/8	1.1250	12	150	28	22	18	.5053	●	●	●	●	●
1 1/4	1.2500	12	150	28	22	18	.5054	●	●	●	●	●
1 3/8	1.3750	12	170	30	28	22	.5055	●	●	●	●	●
1 1/2	1.5000	12	170	30	28	22	.5056	●	●	●	●	●

≈ DIN 371



















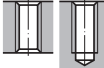



152

152

152

152

152

STEEL Steel materials 	VA Stainless steel materials 						H Materials of high tensile strength 
3B HSSE R35 C / 2-3 E / O	2B NT HSSE B / 4-5 E / O / P	2B TIN HSSE B / 4-5 E / O / P	2B GLT-1 HSSE B / 4-5 E / O / P	2B HSSE R35 C / 2-3 E / O / P	2B GLT-1 HSSE R35 C / 2-3 E / O / P	2BX NT HSSE C / 2-3 E / O / P	
max. 2,5 x d ₁ 	max. 3 x d ₁ 			max. 2,5 x d ₁ 		max. 2 x d ₁ 	
P 1.1-3.1 N 2.2	P 1.1-3.1 M 1.1-2.1 K 2.1 N 2.2, 2.5-6	P 1.1-4.1 M 1.1-3.1 K 2.1 N 2.2, 2.5-6	P 1.1-4.1 M 1.1-3.1 K 2.1 N 2.2	P 1.1-3.1 M 1.1-2.1 K 2.1	P 1.1-4.1 M 1.1-3.1 K 2.1	P 1.1-3.1 K 1.1-4.2 N 2.4-7 N 4.1, 5.1	
C0501010 Enorm 2-STEEL „3B“	C0203000 Rekord 2B-VA NT	C0203100 Rekord 2B-VA TIN	C020C300 Rekord 2B-VA GLT-1	C0503000 Enorm 2-VA	C050C300 Enorm 2-VA GLT-1	C0100501 Rekord 2A-H NT	
							
 153	 153	 153	 153	 153	 153	 153	

- Product Finder
- Vc
- M
- MF
- UNC UN-8
- UNF UNEF
- G, Rp NPSM, NPSF
- NPT, NPTF Rc, W
- BSW, BSF
- Pg
- MJ UNJC, UNJF
- EG (ST) SELF-LOCK
- Tr, Tr-F Rd
- Zubehör Accessories
- Tech. Info

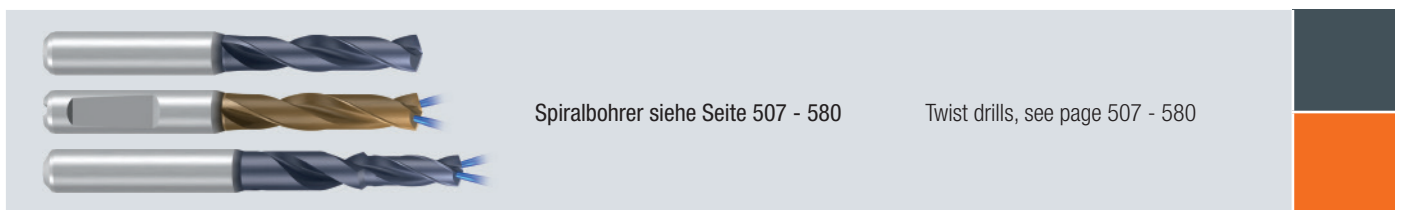
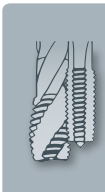

Spiralbohrer siehe Seite 507 - 580

Twist drills, see page 507 - 580

- Product Finder
- Vc
- M
- MF
- UNC UN-8
- UNF UNEF
- G, Rp NPSM, NPSF
- NPT, NPTF Rc, W
- BSW, BSF
- Pg
- MJ UNJC, UNJF
- EG (STI) SELF-LOCK
- Tr, Tr-F Rd
- Zubehör Accessories
- Tech. Info



ASME B1.1

≈ DIN 374

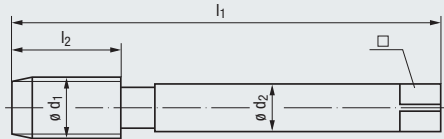

Z
CNC-controlled machines



Toleranz · Tolerance
Beschichtung · Coating
Schneidstoff · Cutting material

Technische Informationen
Technical information

» 245 - 266



2BX	2BX	2BX	2BX
TIN-60	GLT-1	TIN-60	GLT-1
HSSE-PM	HSSE-PM	HSSE-PM	HSSE-PM
R45	R45	R45	R45
C / 2-3	C / 2-3	E / 1,5-2	E / 1,5-2
E / O / P	E / O / P	E / O / P	E / O / P

Gewindetiefe und Lochform
Thread depth and hole type

max. 3 x d₁



Einsatzgebiete – Material
Applications – material

» 22

P 2.1-4.1	P 2.1-4.1	P 2.1-4.1	P 2.1-4.1
M 1.1-3.1	M 1.1-3.1	M 1.1-3.1	M 1.1-3.1
K 2.1	K 2.1	K 2.1	K 2.1
N 1.4-2.2, 2.4-5	N 1.4-2.2, 2.4-5	N 1.4-2.2, 2.4-5	N 1.4-2.2, 2.4-5
S 1.1	S 1.1	S 1.1	S 1.1

Werkzeug-Ident · Tool ident

C5760F01 C576A601 C5820F01 C582A601

Ø d ₁ inch	P Gg/1" (tpi)	l ₁	l ₂	Ø d ₂	□	Dimens.- Ident	Enorm	Enorm	Enorm	Enorm		
							2-Z-X-PM TIN-60	2-Z-X-PM GLT-1	2-Z/E-X-PM TIN-60	2-Z/E-X-PM GLT-1		
1/4	0.2500	28	80	10	4,5	3,4	5,5	.5043				
5/16	0.3125	24	90	10	6	4,9	6,9	.5044				
3/8	0.3750	24	90	10	7	5,5	8,5	.5045				
7/16	0.4375	20	100	13	8	6,2	9,9	.5046	●	●	●	●
1/2	0.5000	20	100	13	9	7	11,5	.5047	●	●	●	●
9/16	0.5625	18	100	15	11	9	12,9	.5048				
5/8	0.6250	18	100	15	12	9	14,5	.5049	●	●	●	●
3/4	0.7500	16	110	17	14	11	17,5	.5050	●	●	●	●
7/8	0.8750	14	125	17	18	14,5	20,4	.5051				
1"	1.0000	12	140	20	18	14,5	23,25	.5052	●	●	●	●
1 1/8	1.1250	12	150	22	22	18	26,5	.5053				
1 1/4	1.2500	12	150	22	22	18	29,5	.5054				
1 3/8	1.3750	12	170	24	28	22	32,75	.5055				
1 1/2	1.5000	12	170	24	28	22	36	.5056				

≈ DIN 371



» 154

» 154

» 154

» 154

UNF

ASME B1.1

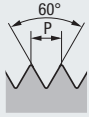

≈ DIN 374

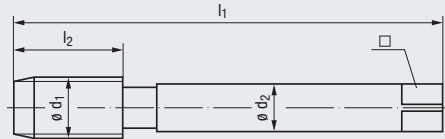

Technische Informationen
Technical information

» 245 - 266

Toleranz · Tolerance
Beschichtung · Coating
Schneidstoff · Cutting material



2B	2B	2B +0,05 1)
HSSE	TIN	HSSE
R45	R45	R45
E / 1,5-2	E / 1,5-2	E / 1,5-2
E / O / P	E / O / P	E / O / P

Gewindetiefe und Lochform
Thread depth and hole type

max. 3 x d₁



Einsatzgebiete – Material
Applications – material

» 22

P 1.1-4.1	P 1.1-4.1	P 1.1-4.1
M 1.1-2.1	M 1.1-3.1	M 1.1-2.1
N 2.1	N 1.4-6	N 2.1
	N 2.1-2, 2.4-5	
	S 1.1	

Werkzeug-Ident · Tool ident

C0513500 C0513700 C0513530

Ø d ₁ inch	P inch	Gg/1" (tpi)	l ₁	l ₂	Ø d ₂	□	Dimens.- Ident	Enorm	Enorm	Enorm
								2-Z/E	2-Z/E TIN	2-Z/E „+0,05“
1/4	0.2500	28	80	10	4,5	3,4	5,5	.5043		
5/16	0.3125	24	90	10	6	4,9	6,9	.5044		
3/8	0.3750	24	90	10	7	5,5	8,5	.5045		
7/16	0.4375	20	100	13	8	6,2	9,9	.5046	●	○
1/2	0.5000	20	100	13	9	7	11,5	.5047	●	○
9/16	0.5625	18	100	15	11	9	12,9	.5048	●	○
5/8	0.6250	18	100	15	12	9	14,5	.5049	●	○
3/4	0.7500	16	110	17	14	11	17,5	.5050	●	○
7/8	0.8750	14	125	17	18	14,5	20,4	.5051	●	○
1"	1.0000	12	140	20	18	14,5	23,25	.5052	●	○
1 1/8	1.1250	12	150	22	22	18	26,5	.5053		
1 1/4	1.2500	12	150	22	22	18	29,5	.5054		
1 3/8	1.3750	12	170	24	28	22	32,75	.5055		
1 1/2	1.5000	12	170	24	28	22	36	.5056		

≈ DIN 371



155

155

155

1) Vorbohrdurchmesser für Gewindebohrer mit Übermaß um 0,05 mm anheben
Increase drill diameter for taps with oversize by 0.05 mm



Gewinde-Tiefenlehndorne
siehe Seite 624 - 627

Thread depth plug gauges,
see page 624 - 627

- Product Finder
- Vc
- M
- MF
- UNC UN-8
- UNF UNEF
- G, Rp NPSM, NPSF
- NPT, NPTF Rc, W
- BSW, BSF
- Pg
- MJ UNJC, UNJF
- EG (STI) SELF-LOCK
- Tr, Tr-F Rd
- Zubehör Accessories
- Tech. Info



ASME B1.1

≈ DIN 2181

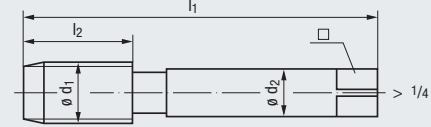
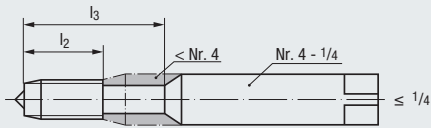

STEEL
Steel materials



Technische Informationen
Technical information

» 245 - 266

Toleranz · Tolerance
Beschichtung · Coating
Schneidstoff · Cutting material



2BX

HSSE

C / 2-3

E / 0

Gewindetiefe und Lochform
Thread depth and hole type

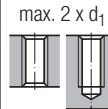

Einsatzgebiete – Material
Applications – material

» 22

P 1.1-3.1

N 2.3

Werkzeug-Ident · Tool ident

A0101001

Nr.	ø d ₁		P Gg/1" (tpi)	l ₁	l ₂	l ₃	ø d ₂	□	Rekord A-STEEL	
	inch	inch								
Nr. 0	0.0600		80	32	8	–	2,5	2,1	1,25	.5033
Nr. 1	0.0730		72	36	8	–	2,8	2,1	1,55	.5034
Nr. 2	0.0860		64	36	9	–	2,8	2,1	1,85	.5035
Nr. 3	0.0990		56	40	9	–	2,8	2,1	2,15	.5036
Nr. 4	0.1120		48	40	10	18	3,5	2,7	2,4	.5037
Nr. 5	0.1250		44	40	10	18	3,5	2,7	2,7	.5038
Nr. 6	0.1380		40	45	11	20	4	3	2,95	.5039
Nr. 8	0.1640		36	45	12	22	4,5	3,4	3,5	.5040
Nr. 10	0.1900		32	50	14	25	6	4,9	4,1	.5041
Nr. 12	0.2160		28	56	16	28	6	4,9	4,6	.5042
1/4	0.2500		28	56	16	28	6	4,9	5,5	.5043
5/16	0.3125		24	63	17	–	6	4,9	6,9	.5044
3/8	0.3750		24	63	18	–	7	5,5	8,5	.5045
7/16	0.4375		20	70	22	–	8	6,2	9,9	.5046
1/2	0.5000		20	70	20	–	9	7	11,5	.5047
9/16	0.5625		18	70	20	–	11	9	12,9	.5048
5/8	0.6250		18	70	20	–	12	9	14,5	.5049
3/4	0.7500		16	80	22	–	14	11	17,5	.5050
7/8	0.8750		14	80	22	–	18	14,5	20,4	.5051
1"	1.0000		12	90	22	–	18	14,5	23,25	.5052
1 1/8	1.1250		12	90	22	–	22	18	26,5	.5053
1 1/4	1.2500		12	90	22	–	22	18	29,5	.5054
1 3/8	1.3750		12	125	30	–	28	22	32,75	.5055
1 1/2	1.5000		12	125	30	–	28	22	36	.5056

UNF



ASME B1.1

≈ DIN 2181

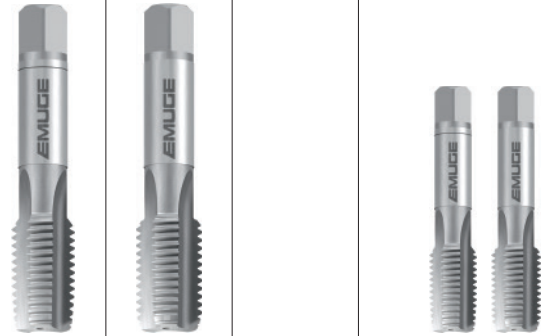
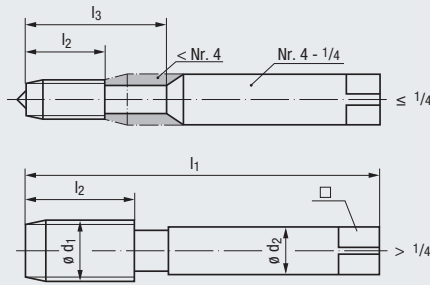

Technische Informationen
Technical information

» 245 - 266

Toleranz · Tolerance
Beschichtung · Coating
Schneidstoff · Cutting material



	2BX	2BX
HSSE	HSSE	HSSE
D / 3-4	C / 2-3	C / 2-3
O / P	O / P	O / P

Gewindetiefe und Lochform
Thread depth and hole type



Einsatzgebiete – Material
Applications – material

» 22

P 1.1-3.1 P 1.1-3.1 P 1.1-3.1

Werkzeug-Ident · Tool ident

H0211009 H0211001 H0201001

ø d ₁ inch	inch	P Gg/1" (tpi)	l ₁	l ₂	l ₃	ø d ₂	□	Dimens.- Ident	HGB-Set	HGB-Set	HGB-Set	
									V-Nr.1	F	2S (Nr.1, F)	
Nr. 0	0.0600	80	32	8	–	2,5	2,1	1,25	.5033			
Nr. 1	0.0730	72	36	8	–	2,8	2,1	1,55	.5034	○	○	○
Nr. 2	0.0860	64	36	9	–	2,8	2,1	1,85	.5035	○	○	○
Nr. 3	0.0990	56	40	9	–	2,8	2,1	2,15	.5036			
Nr. 4	0.1120	48	40	10	18	3,5	2,7	2,4	.5037	○	○	○
Nr. 5	0.1250	44	40	10	18	3,5	2,7	2,7	.5038			
Nr. 6	0.1380	40	45	11	20	4	3	2,95	.5039	○	○	○
Nr. 8	0.1640	36	45	12	22	4,5	3,4	3,5	.5040	○	○	○
Nr. 10	0.1900	32	50	14	25	6	4,9	4,1	.5041	○	○	○
Nr. 12	0.2160	28	56	16	28	6	4,9	4,6	.5042			
1/4	0.2500	28	56	16	28	6	4,9	5,5	.5043	○	○	○
5/16	0.3125	24	63	17	–	6	4,9	6,9	.5044	○	○	○
3/8	0.3750	24	63	18	–	7	5,5	8,5	.5045	○	○	○
7/16	0.4375	20	70	22	–	8	6,2	9,9	.5046	○	○	○
1/2	0.5000	20	70	20	–	9	7	11,5	.5047	○	○	○
9/16	0.5625	18	70	20	–	11	9	12,9	.5048			
5/8	0.6250	18	70	20	–	12	9	14,5	.5049	○	○	○
3/4	0.7500	16	80	22	–	14	11	17,5	.5050	○	○	○
7/8	0.8750	14	80	22	–	18	14,5	20,4	.5051			
1"	1.0000	12	90	22	–	18	14,5	23,25	.5052	○	○	○
1 1/8	1.1250	12	90	22	–	22	18	26,5	.5053	○	○	○
1 1/4	1.2500	12	90	22	–	22	18	29,5	.5054	○	○	○
1 3/8	1.3750	12	125	30	–	28	22	32,75	.5055	○	○	○
1 1/2	1.5000	12	125	30	–	28	22	36	.5056	○	○	○



Verstellbare Windeisen siehe Seite 243

Adjustable tap wrenches, see page 243

- Product Finder
- V_c
- M
- MF
- UNC
UN-8
- UNF
UNEF
- G, Rp
NPSM, NPSF
- NPT, NPTF
Rc, W
- BSW, BSF
- Pg
- MJ
UNJC, UNJF
- EG (STI)
SELF-LOCK
- Tr, Tr-F
Rd
- Zubehör
Accessories
- Tech. Info



UNF

ASME B1.1

≈ DIN
2181

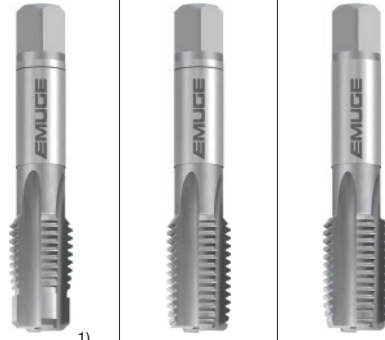
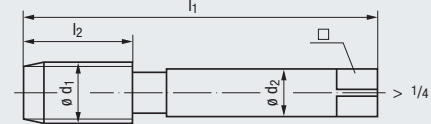
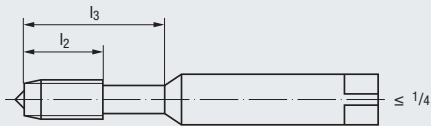

Toleranz · Tolerance
Beschichtung · Coating
Schneidstoff · Cutting material

Technische Informationen
Technical information

» 245 - 266



HSSE	HSSE	HSSE
C / 2-3	C / 2-3	C / 2-3
O / P	O / P	O / P

Gewindetiefe und Lochform
Thread depth and hole type

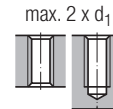

Einsatzgebiete – Material
Applications – material

» 22

P 1.1-5.1	P 1.1-5.1	P 1.1-5.1
M 1.1-4.1	M 1.1-4.1	M 1.1-4.1
S 2.1-2, 2.4	S 2.1-2, 2.4	S 2.1-2, 2.4

Werkzeug-Ident · Tool ident

H0463009 H0473009 H0473001

Ø d ₁ inch	P Gg/1" (tpi)	l ₁	l ₂	l ₃	Ø d ₂	□	Dimens.- Ident	WM-Set	WM-Set	WM-Set		
								V-Nr.1Z	V-Nr.1	F		
1/4	0.2500	28	56	16	28	6	4,9	5,5	.5043	●	●	●
5/16	0.3125	24	63	17	–	6	4,9	6,9	.5044	●	●	●
3/8	0.3750	24	63	18	–	7	5,5	8,5	.5045	●	●	●
7/16	0.4375	20	70	22	–	8	6,2	9,9	.5046	●	●	●
1/2	0.5000	20	70	20	–	9	7	11,5	.5047	●	●	●
9/16	0.5625	18	70	20	–	11	9	12,9	.5048	○	○	○
5/8	0.6250	18	70	20	–	12	9	14,5	.5049	○	○	○
3/4	0.7500	16	80	22	–	14	11	17,5	.5050	○	○	○
7/8	0.8750	14	80	22	–	18	14,5	20,4	.5051	○	○	○
1"	1.0000	12	90	22	–	18	14,5	23,25	.5052	○	○	○

1) Der Vorschneider Nr.1Z mit Führungzapfen ist eine zusätzliche Hilfe zum winkelrechten Anschneiden von Hand. Er kann z.B. auf der Maschine weggelassen werden. Die Profilabstufung von Nr.1Z und Nr.1 ist gleich.
The taper tap No. 1Z with cylindrical pilot is an additional aid for true alignment especially when tapping by hand. It can be deleted when tapping by machine. The profile graduation of No.1Z, and No.1 is the same.

Product Finder

V_c

M

MF

UNC
UN-8

UNF
UNEF

G, Rp
NPSM, NPSF

NPT, NPTF
Rc, W

BSW, BSF

Pg

MJ
UNJC, UNJF

EG (STI)
SELF-LOCK

Tr, Tr-F
Rd

Zubehör
Accessories

Tech. Info

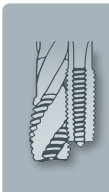

<p>2)</p>			
<p>2BX</p> <p>HSSE</p> <p>C / 2-3</p> <p>O / P</p>	<p>2BX</p> <p>HSSE</p> <p>C / 2-3</p> <p>O / P</p>		
<p>max. 2 x d₁</p>			
<p>P 1.1-5.1</p> <p>M 1.1-4.1</p> <p>S 2.1-2, 2.4</p>	<p>P 1.1-5.1</p> <p>M 1.1-4.1</p> <p>S 2.1-2, 2.4</p>		
<p>H0453001</p> <p>WM-Set</p> <p>3S</p> <p>(Nr.1Z, Nr.1, F)</p>	<p>H0483001</p> <p>WM-Set</p> <p>2S</p> <p>(Nr.1, F)</p>		
<p>●</p> <p>●</p> <p>●</p> <p>●</p> <p>○</p> <p>○</p> <p>○</p>	<p>●</p> <p>●</p> <p>●</p> <p>●</p> <p>○</p> <p>○</p> <p>○</p>		

1/4 - 28
5/16 - 24
3/8 - 24
7/16 - 20
1/2 - 20
9/16 - 18
5/8 - 18
3/4 - 16
7/8 - 14
1" - 12

2) Beim Gewindebohren von Hand in Durchgangslöcher entfällt Nr.1
No.1 is not needed when tapping in through holes by hand

- Product Finder
- Vc
- M
- MF
- UNC UN-8
- UNF UNEF
- G, Rp NPSM, NPSF
- NPT, NPTF Rc, W
- BSW, BSF
- Pg
- MJ UNJC, UNJF
- EG (STI) SELF-LOCK
- Tr, Tr-F Rd
- Zubehör Accessories
- Tech. Info

UNEF

ASME B1.1

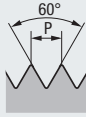

≈ DIN 374

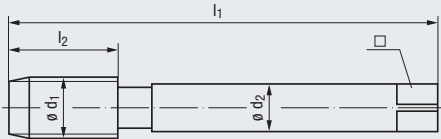

STEEL
Steel materials

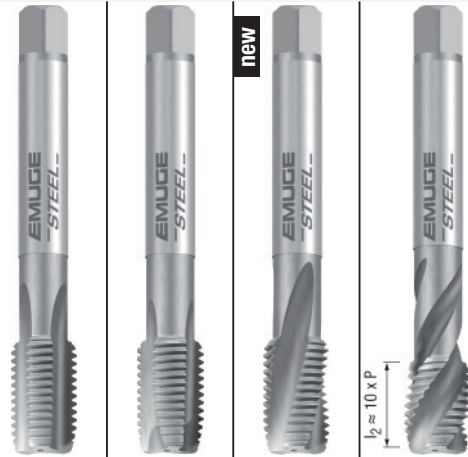

Toleranz · Tolerance
Beschichtung · Coating
Schneidstoff · Cutting material

Technische Informationen
Technical information

» 245 - 266

2BX	2B	2B	2B
HSSE	HSSE	HSSE	HSSE
C / 2-3	B / 4-5	E / 1,5-2	C / 2-3
E / 0	E / 0	E / 0	E / 0

Gewindetiefe und Lochform
Thread depth and hole type

max. 2 x d ₁	max. 3 x d ₁	max. 2 x d ₁	max. 2,5 x d ₁

Einsatzgebiete – Material
Applications – material

» 22

P 1.1-3.1 N 2.3	P 2.1-4.1	P 2.1-3.1	P 1.1-3.1 N 2.2
--------------------	-----------	-----------	--------------------

Werkzeug-Ident · Tool ident

C0101001	C0201000	C0461000	C0501000
----------	----------	----------	----------

Ø d ₁ inch	P Gg/1" (tpi)	l ₁	l ₂	Ø d ₂	□		Dimens.- Ident	Rekord	Rekord	Rekord	Enorm	
								2A-STEEL	2B-STEEL-M	2D-STEEL/E	2-STEEL	
1/4	0.2500	32	80	14	4,5	3,4	5,55	.5058	○	●	●	●
5/16	0.3125	32	80	14	6	4,9	7,15	.5059	○	●	●	●
3/8	0.3750	32	90	18	7	5,5	8,7	.5060	○	●	●	●
7/16	0.4375	28	90	18	8	6,2	10,2	.5061	○	●	●	●
1/2	0.5000	28	100	18	9	7	11,8	.5062	○	●	●	●
9/16	0.5625	24	100	18	11	9	13,2	.5063	○	●	●	●
5/8	0.6250	24	100	18	12	9	14,8	.5064	○	●	●	●
3/4	0.7500	20	110	25	14	11	17,8	.5066	○	●	●	●
7/8	0.8750	20	125	25	18	14,5	20,95	.5068	○	●	●	●
1"	1.0000	20	140	28	18	14,5	24,15	.5070	○	●	●	●

UNEF

ASME B1.1

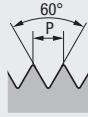

≈ DIN 374

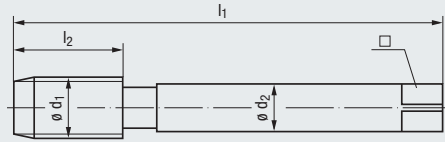

Technische Informationen
Technical information

» 245 - 266

Toleranz · Tolerance
Beschichtung · Coating
Schneidstoff · Cutting material



2B	2B
TIN	GLT-1
HSSE	HSSE
B / 4-5	B / 4-5
E / O / P	E / O / P

Gewindetiefe und Lochform
Thread depth and hole type

max. 3 x d₁



Einsatzgebiete – Material
Applications – material

» 22

P 1.1-4.1	P 1.1-4.1
M 1.1-3.1	M 1.1-3.1
K 2.1	K 2.1
N 2.2, 2.5-6	N 2.2

Werkzeug-Ident · Tool ident

C0203100 C020C300

ø d ₁ inch	P Gg/1" (tpi)	l ₁	l ₂	ø d ₂	□	Image	Dimens.-Ident	Rekord 2B-VA TIN	Rekord 2B-VA GLT-1	
1/4	0.2500	32	80	14	4,5	3,4	5,55	.5058	●	○
5/16	0.3125	32	80	14	6	4,9	7,15	.5059	●	○
3/8	0.3750	32	90	18	7	5,5	8,7	.5060	●	○
7/16	0.4375	28	90	18	8	6,2	10,2	.5061	●	○
1/2	0.5000	28	100	18	9	7	11,8	.5062	●	○
9/16	0.5625	24	100	18	11	9	13,2	.5063	●	○
5/8	0.6250	24	100	18	12	9	14,8	.5064	●	○
3/4	0.7500	20	110	25	14	11	17,8	.5066	●	○
7/8	0.8750	20	125	25	18	14,5	20,95	.5068	●	○
1"	1.0000	20	140	28	18	14,5	24,15	.5070	●	○

- Product Finder
- V_c
- M
- MF
- UNC UN-8
- UNF UNEF
- G, Rp NPSM, NPSF
- NPT, NPTF Rc, W
- BSW, BSF
- Pg
- MJ UNJC, UNJF
- EG (ST) SELF-LOCK
- Tr, Tr-F Rd
- Zubehör Accessories
- Tech. Info



- Product Finder
- Vc
- M
- MF
- UNC UN-8
- UNF UNEF
- G Rp NPSM, NPSF
- NPT, NPTF Rc, W
- BSW, BSF
- Pg
- MJ UNJC, UNJF
- EG (STI) SELF-LOCK
- Tr, Tr-F Rd
- Zubehör Accessories
- Tech. Info

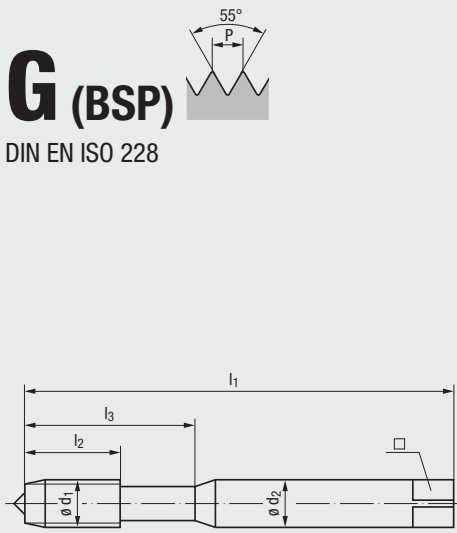

≈ DIN 371

HCUT
Hardened steels



Technische Informationen
Technical information

» 245 - 266

Toleranz · Tolerance
Beschichtung · Coating
Schneidstoff · Cutting material



- „X“
- TICN
- HSSE-PM**
- C / 2-3
- O / P

Gewindetiefe und Lochform
Thread depth and hole type

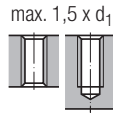

Einsatzgebiete – Material
Applications – material

» 22

H 1.1-2

Werkzeug-Ident · Tool ident

B010J901

Nenngröße Nom. size									Dimens.-Ident
Ø d ₁	Ø d ₁ mm	P Gg/1" (tpi)	l ₁	l ₂	l ₃	Ø d ₂	□		
G	1/8	9,73	28	90	10	35	10	8	8,8

**Rekord
1A-HCUT-PM
TICN**

DIN 5156



» 171



≈ DIN 371

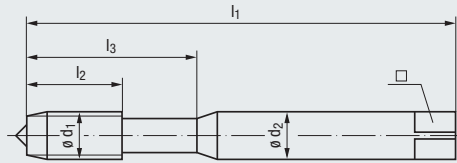

HCUT
Hardened steels



- Product Finder
- Vc
- M
- MF
- UNC UN-8
- UNF UNEF
- G, Rp** NPSM, NPSF
- NPT, NPTF Rc, W
- BSW, BSF
- Pg
- MJ UNJC, UNJF
- EG (ST) SELF-LOCK
- Tr, Tr-F Rd
- Zubehör Accessories
- Tech. Info

Toleranz · Tolerance
Beschichtung · Coating
Schneidstoff · Cutting material

Technische Informationen
Technical information

» 245 - 266



„X“	„X“
TICN	TICN
VHM	VHM
D / 4-5	C / 2-3
O / P	O / P

Gewindetiefe und Lochform
Thread depth and hole type

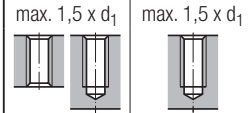

Einsatzgebiete – Material
Applications – material

» 22

H 1.3-4

Werkzeug-Ident · Tool ident

Nenngröße Nom. size	Dimens.-Ident								Dimens.-Ident	
	Ø d ₁	Ø d ₁ mm	P Gg/1" (tpi)	l ₁	l ₂	l ₃	Ø d ₂	□		
G	1/8	9,73	28	100	18	38	10	8	8,8	.4035
	1/4	13,16	19	110	24	44	14	11	11,9	.4036

B016K101	B010K101
VHM Rekord 1A-HCUT/D TICN	VHM Rekord 1A-HCUT/C TICN
●	●
●	●

2) Achtung: VHM-Rekord 1A-HCUT/D-TICN als Vorschneider verwenden!
Please note: Use solid carbide tap VHM-Rekord 1A-HCUT/D-TICN as No.1 tap!



Spiralbohrer Typ EF-Drill-HCUT
siehe Seite 558

Twist drills type EF-Drill-HCUT,
see page 558

- Product Finder
- V_c
- M
- MF
- UNC UN-8
- UNF UNEF
- G Rp NPSM, NPSF
- NPT, NPTF Rc, W
- BSW, BSF
- Pg
- MJ UNJC, UNJF
- EG (STI) SELF-LOCK
- Tr, Tr-F Rd
- Zubehör Accessories
- Tech. Info

G (BSP)

DIN EN ISO 228

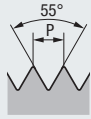

DIN 5156

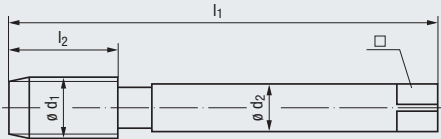

STEEL
Steel materials



Toleranz · Tolerance
Beschichtung · Coating
Schneidstoff · Cutting material

Technische Informationen
Technical information

» 245 - 266



„X“				
HSSE	HSSE	TIN HSSE	HSSE	TIN HSSE
C / 2-3 E / 0	B / 4-5 E / 0	B / 4-5 E / 0	B / 4-5 E / 0	B / 4-5 E / 0

Gewindetiefe und Lochform
Thread depth and hole type



Einsatzgebiete – Material
Applications – material

» 22

P 1.1-3.1 N 2.3	P 1.1-3.1 N 2.2	P 1.1-4.1 K 2.1 N 2.2, 2.4-5	P 2.1-4.1	P 2.1-4.1 K 2.1
--------------------	--------------------	------------------------------------	-----------	--------------------

Werkzeug-Ident · Tool ident

Nenngröße Nom. size	Ø d ₁	Ø d ₁ mm	P Gg/1" (tpi)	l ₁	l ₂	Ø d ₂	□	Ø	Dimens.- Ident	C0101001	C0208900	C0208400	C0201000	C0201400
										Rekord 2A-STEEL	Rekord 2B-STEEL-L	Rekord 2B-STEEL-L TIN	Rekord 2B-STEEL-M	Rekord 2B-STEEL-M TIN
G 1/16	7,72	28	90	17	6	4,9	6,8	.4034	●	●	●	●	●	
1/8	9,73	28	90	18	7	5,5	8,8	.4035	●	●	●	●	●	
1/4	13,16	19	100	22	11	9	11,8	.4036	●	●	●	●	●	
3/8	16,66	19	100	22	12	9	15,25	.4037	●	●	●	●	●	
1/2	20,96	14	125	25	16	12	19	.4038	●	●	●	●	●	
5/8	22,91	14	125	25	18	14,5	21	.4039	○	●	○	●	○	
3/4	26,44	14	140	28	20	16	24,5	.4040	●	●	●	●	○	
7/8	30,20	14	150	28	22	18	28,25	.4041	○	●	●	●	●	
1"	33,25	11	160	30	25	20	30,75	.4042	○	●	●	●	●	
1 1/8	37,90	11	170	30	28	22	35,5	.4043	○	●	●	●	●	
1 1/4	41,91	11	170	30	32	24	39,5	.4044	○	●	●	●	●	
1 3/8	44,32	11	180	32	36	29	41,75	.4045	○	●	●	●	●	
1 1/2	47,80	11	190	32	36	29	45,25	.4046	○	●	●	●	●	
1 5/8	52,00	11	190	32	40	32	49,5	.4047	○	●	●	●	●	
1 3/4	53,75	11	190	32	40	32	51	.4048	○	●	●	●	●	
2"	59,61	11	220	40	45	35	57	.4050	○	●	●	●	●	



174



STEEL Steel materials					VA Stainless steel materials				
HSSE	HSSE	TIN HSSE	HSSE	TIN HSSE	NT HSSE	TIN HSSE	GLT-1 HSSE	HSSE	
R15	R15	R15	R35	R35	B / 4-5	B / 4-5	B / 4-5	R35	
C / 2-3	E / 1,5-2	C / 2-3	C / 2-3	C / 2-3	E / 0 / P	E / 0 / P	E / 0 / P	C / 2-3	
E / 0	E / 0	E / 0	E / 0	E / 0				E / 0 / P	



P 2.1-3.1	P 2.1-3.1	P 1.1-4.1 K 1.1-4.2 N 1.4-5, 2.4-5	P 1.1-3.1 N 2.2	P 1.1-4.1 K 2.1 N 2.2	P 1.1-3.1 M 1.1-2.1 K 2.1 N 2.2, 2.5-6	P 1.1-4.1 M 1.1-3.1 K 2.1 N 2.2, 2.5-6	P 1.1-4.1 M 1.1-3.1 K 2.1 N 2.2	P 1.1-3.1 M 1.1-2.1 K 2.1
-----------	-----------	--	--------------------	-----------------------------	---	---	--	---------------------------------

C0451000	C0461000	C0401400	C0501000	C0501400	C0203000	C0203100	C020C300	C0503000
Rekord 2D-STEEL	Rekord 2D-STEEL/E	Rekord 2DF-STEEL TIN	Enorm 2-STEEL	Enorm 2-STEEL TIN	Rekord 2B-VA NT	Rekord 2B-VA TIN	Rekord 2B-VA GLT-1	Enorm 2-VA

○	○	●	○	○	●	○	○	○	G 1/16 - 28
●	●	●	●	●	●	○	○	●	1/8 - 28
●	●	●	●	●	●	○	○	●	1/4 - 19
●	●	●	●	●	●	○	○	●	3/8 - 19
○	○	○	○	○	○	○	○	○	1/2 - 14
●	●	○	●	●	●	○	○	●	5/8 - 14
○	○	○	○	○	○	○	○	○	3/4 - 14
●	●	○	○	●	●	○	○	○	7/8 - 14
○	○	○	○	○	○	○	○	○	1" - 11
○	○	○	○	○	○	○	○	○	1 1/8 - 11
○	○	○	○	○	○	○	○	○	1 1/4 - 11
○	○	○	○	○	○	○	○	○	1 3/8 - 11
○	○	○	○	○	○	○	○	○	1 1/2 - 11
○	○	○	○	○	○	○	○	○	1 5/8 - 11
○	○	○	○	○	○	○	○	○	1 3/4 - 11
○	○	○	○	○	○	○	○	○	2" - 11

- Product Finder
- Vc
- M
- MF
- UNC UN-8
- UNF
- G, Rp NPSM, NPSF
- NPT, NPTF Rc, W
- BSW, BSF
- Pg
- MJ UNJC, UNJF
- EG (STI) SELF-LOCK
- Tr, Tr-F Rd
- Zubehör Accessories
- Tech. Info

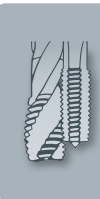

- Product Finder
- Vc
- M
- MF
- UNC UN-8
- UNF UNEF
- G Rp NPSM, NPSF
- NPT, NPTF Rc, W
- BSW, BSF
- Pg
- MJ UNJC, UNJF
- EG (STI) SELF-LOCK
- Tr, Tr-F Rd
- Zubehör Accessories
- Tech. Info

G (BSP)

DIN EN ISO 228



DIN 5156

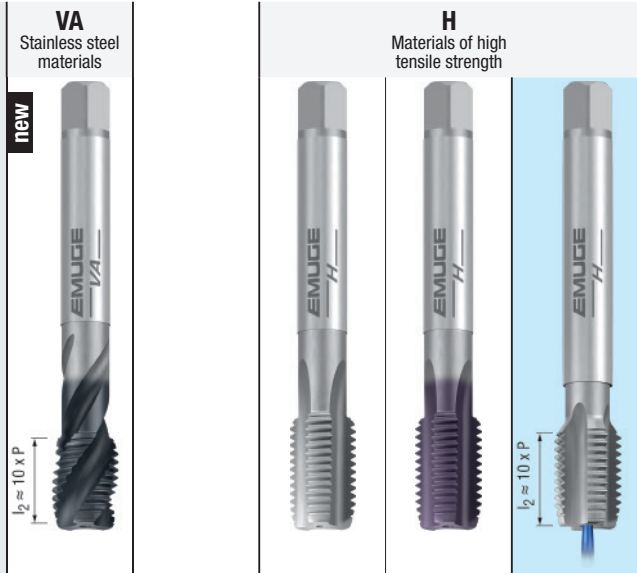
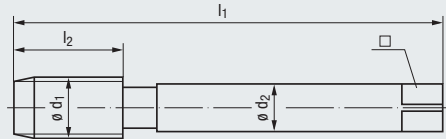

Technische Informationen Technical information ▶ 245 - 266	Toleranz · Tolerance		„X“	„X“	„X“
	Beschichtung · Coating	GLT-1	NT	TICN	
	Schneidstoff · Cutting material	HSSE	HSSE	HSSE	VHM/KHM
		R35	C / 2-3	C / 2-3	E / 1,5-2
		C / 2-3	E / O / P	E / O / P	E / O

Gewindetiefe und Lochform Thread depth and hole type	max. 2,5 x d ₁	max. 2 x d ₁	max. 2 x d ₁	max. 2 x d ₁



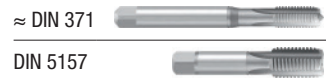

Einsatzgebiete – Material Applications – material ▶ 22	P 1.1-4.1	P 1.1-3.1	P 1.1-4.1	P 5.1
	M 1.1-3.1	K 1.1-4.2	K 1.1-4.2	K 1.1-4.2
	K 2.1	N 2.4-7	N 2.4-7	N 1.5-6, 2.6-8
		N 4.1, 5.1	N 4.1, 5.1	N 4.1, 4.3-5.2
				H 1.1-2

Werkzeug-Ident · Tool ident										C050C300	C0100501	C0109101	C1960901
Nenngröße Nom. size									Dimens.- Ident	Enorm 2-VA GLT-1	Rekord 2A-H NT	Rekord 2A-H TICN	VHM/KHM Rekord 2A-H/E-1KZ
Ø d ₁	Ø d ₁ mm	P Gg/1" (tpi)	l ₁	l ₂	Ø d ₂	□							
G	1/16	7,72	28	90	17	6	4,9	6,8	.4034	●	○	●	●
	1/8	9,73	28	90	18	7	5,5	8,8	.4035	●	●	●	●
	1/4	13,16	19	100	22	11	9	11,8 2)	.4036	●	●	●	●
	3/8	16,66	19	100	22	12	9	15,25 2)	.4037	●	●	●	●
	1/2	20,96	14	125	25	16	12	19 2)	.4038	●	●	●	●
	5/8	22,91	14	125	25	18	14,5	21	.4039	○	○		
	3/4	26,44	14	140	28	20	16	24,5	.4040	●	○		
	7/8	30,20	14	150	28	22	18	28,25	.4041	○	○		
	1"	33,25	11	160	30	25	20	30,75	.4042	●	○		
	1 1/8	37,90	11	170	30	28	22	35,5	.4043	○	○		
	1 1/4	41,91	11	170	30	32	24	39,5	.4044	○	○		
	1 3/8	44,32	11	180	32	36	29	41,75	.4045	○	○		
	1 1/2	47,80	11	190	32	36	29	45,25	.4046	●			
	1 5/8	52,00	11	190	32	40	32	49,5	.4047				
	1 3/4	53,75	11	190	32	40	32	51	.4048		○		
	2"	59,61	11	220	40	45	35	57	.4050		○		

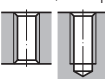

1) Gewindebohren in Durchgangslöcher nur mit externer Kühlschmierung möglich
 Threading in through holes is possible only with external cooling/lubrication

2) Vorbohrerdurchmesser für Gewindebohrer Rekord 2A-HCUT-PM-TICN ab G 1/4 um 0,1 mm anheben
 Increase drill diameter for taps Rekord 2A-HCUT-PM-TICN from G 1/4 by 0.1 mm

<p>HCUT Hardened steels</p>  <p>l₂ ≈ 10 x P</p>	<p>Z CNC-controlled machines</p> 									
<p>„X“ TiCN HSSE-PM C / 2-3 O / P</p>	<p>new „X“ TIN-60 HSSE-PM R45 C / 2-3 E / O / P</p>	<p>new „X“ GLT-1 HSSE-PM R45 C / 2-3 E / O / P</p>	<p>new „X“ TIN-60 HSSE-PM R45 C / 2-3 E / O</p>	<p>new „X“ GLT-1 HSSE-PM R45 C / 2-3 E / O</p>	<p>new „X“ TIN-60 HSSE-PM R45 E / 1,5-2 E / O / P</p>	<p>new „X“ GLT-1 HSSE-PM R45 E / 1,5-2 E / O / P</p>	<p>new „X“ TIN-60 HSSE-PM R45 E / 1,5-2 E / O</p>	<p>new „X“ GLT-1 HSSE-PM R45 E / 1,5-2 E / O</p>	<p>new „X“ TIN-60 HSSE-PM R45 E / 1,5-2 E / O</p>	<p>new „X“ GLT-1 HSSE-PM R45 E / 1,5-2 E / O</p>
<p>max. 1,5 x d₁ </p>	<p>max. 3 x d₁ </p>									
<p>H 1.1-2</p>	<p>P 2.1-4.1 M 1.1-3.1 K 2.1 N 1.4-2.2, 2.4-5 S 1.1</p>	<p>P 2.1-4.1 M 1.1-3.1 K 2.1 N 1.4-2.2, 2.4-5 S 1.1</p>	<p>P 2.1-4.1 M 1.1-3.1 K 2.1 N 1.4-2.2, 2.4-5 S 1.1</p>	<p>P 2.1-4.1 M 1.1-3.1 K 2.1 N 1.4-2.2, 2.4-5 S 1.1</p>	<p>P 2.1-4.1 M 1.1-3.1 K 2.1 N 1.4-2.2, 2.4-5 S 1.1</p>	<p>P 2.1-4.1 M 1.1-3.1 K 2.1 N 1.4-2.2, 2.4-5 S 1.1</p>	<p>P 2.1-4.1 M 1.1-3.1 K 2.1 N 1.4-2.2, 2.4-5 S 1.1</p>	<p>P 2.1-4.1 M 1.1-3.1 K 2.1 N 1.4-2.2, 2.4-5 S 1.1</p>	<p>P 2.1-4.1 M 1.1-3.1 K 2.1 N 1.4-2.2, 2.4-5 S 1.1</p>	<p>P 2.1-4.1 M 1.1-3.1 K 2.1 N 1.4-2.2, 2.4-5 S 1.1</p>
<p>C010J901 Rekord 2A-HCUT-PM TiCN</p>	<p>C5760F01 Enorm 2-Z-X-PM TIN-60</p>	<p>C576A601 Enorm 2-Z-X-PM GLT-1</p>	<p>C5810F01 Enorm 2-Z-X IKZ-PM TIN-60</p>	<p>C581A601 Enorm 2-Z-X IKZ-PM GLT-1</p>	<p>C5820F01 Enorm 2-Z/E-X-PM TIN-60</p>	<p>C582A601 Enorm 2-Z/E-X-PM GLT-1</p>	<p>C5830F01 Enorm 2-Z/E-X IKZ-PM TIN-60</p>	<p>C583A601 Enorm 2-Z/E-X IKZ-PM GLT-1</p>		
<p>● ● ● ●</p>	<p>● ● ● ● ● ●</p>	<p>● ● ● ● ● ●</p>	<p>● ● ● ● ● ●</p>	<p>● ● ● ● ● ●</p>	<p>● ● ● ● ● ●</p>	<p>● ● ● ● ● ●</p>	<p>● ● ● ● ● ●</p>	<p>● ● ● ● ● ●</p>	<p>● ● ● ● ● ●</p>	<p>G 1/16 - 28 1/8 - 28 1/4 - 19 3/8 - 19 1/2 - 14 5/8 - 14 3/4 - 14 7/8 - 14 1" - 11 1 1/8 - 11 1 1/4 - 11 1 3/8 - 11 1 1/2 - 11 1 5/8 - 11 1 3/4 - 11 2" - 11</p>
<p>166</p>										

- Product Finder
- V_c
- M
- MF
- UNC UN-8
- UNF UNEF
- G, Rp NPSM, NPSF
- NPT, NPTF Rc, W
- BSW, BSF
- Pg
- MJ UNJC, UNJF
- EG (STI) SELF-LOCK
- Tr, Tr-F Rd
- Zubehör Accessories
- Tech. Info

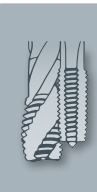

Schnellwechsel-Aufnahmen
Typ KSN/HD siehe Seite 698 - 705

Quick-change tap holders
type KSN/HD, see page 698 - 705

- Product Finder
- V_c
- M
- MF
- UNC UN-8
- UNF UNEF
- G Rp NPSM, NPSF
- NPT, NPTF Rc, W
- BSW, BSF
- Pg
- MJ UNJC, UNJF
- EG (STI) SELF-LOCK
- Tr, Tr-F Rd
- Zubehör Accessories
- Tech. Info

G (BSP)

DIN EN ISO 228



DIN 5156

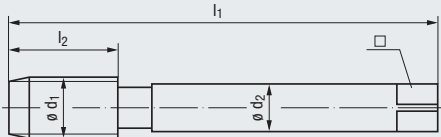

Z
CNC-controlled machines



Technische Informationen
Technical information

245 - 266

Toleranz · Tolerance
Beschichtung · Coating
Schneidstoff · Cutting material



	TIN	+0,05 ¹⁾
HSSE	HSSE	HSSE
R45	R45	R45
E / 1,5-2	E / 1,5-2	E / 1,5-2
E / O / P	E / O / P	E / O / P

Gewindetiefe und Lochform
Thread depth and hole type

max. 3 x d₁



Einsatzgebiete – Material
Applications – material

22

P 1.1-4.1	P 1.1-4.1	P 1.1-4.1
M 1.1-2.1	M 1.1-3.1	M 1.1-2.1
N 2.1	N 1.4-6	N 2.1
	N 2.1-2, 2.4-5	
S 1.1		

Werkzeug-Ident · Tool ident

C0513500 C0513700 C0513530

Nenngröße Nom. size	Ø d ₁	Ø d ₁ mm	P Gg/1" (tpi)	l ₁	l ₂	Ø d ₂	□	Ø	Dimens.- Ident	Enorm	Enorm	Enorm
										2-Z/E	2-Z/E TIN	2-Z/E „+0,05“
G	1/16	7,72	28	90	10	6	4,9	6,8	.4034	○	●	●
	1/8	9,73	28	90	10	7	5,5	8,8	.4035	●	●	●
	1/4	13,16	19	100	15	11	9	11,8	.4036	●	●	●
	3/8	16,66	19	100	15	12	9	15,25	.4037	●	●	●
	1/2	20,96	14	125	17	16	12	19	.4038	●	●	●
	5/8	22,91	14	125	17	18	14,5	21	.4039	○	○	○
	3/4	26,44	14	140	20	20	16	24,5	.4040	●	●	○
	7/8	30,20	14	150	22	22	18	28,25	.4041	○	○	○
	1"	33,25	11	160	24	25	20	30,75	.4042	●	●	○
	1 1/8	37,90	11	170	24	28	22	35,5	.4043			
	1 1/4	41,91	11	170	25	32	24	39,5	.4044	○		
	1 3/8	44,32	11	180	27	36	29	41,75	.4045			
	1 1/2	47,80	11	190	27	36	29	45,25	.4046	○		
	1 5/8	52,00	11	190	27	40	32	49,5	.4047			
	1 3/4	53,75	11	190	27	40	32	51	.4048			
	2"	59,61	11	220	32	45	35	57	.4050			

¹⁾ Vorbohrdurchmesser für Gewindebohrer mit Übermaß um 0,05 mm anheben
Increase drill diameter for taps with oversize by 0.05 mm

G (BSP)

DIN EN ISO 228

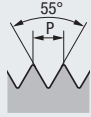

DIN 5156

Mit Spanglocke
With internal chip collector

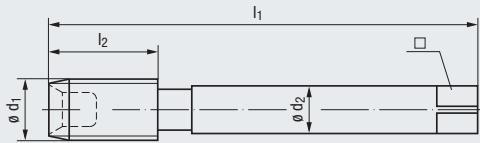

Technische Informationen
Technical information

» 245 - 266

Toleranz · Tolerance
Beschichtung · Coating
Schneidstoff · Cutting material



Gewindetiefe und Lochform
Thread depth and hole type

max. 1,5 x d₁

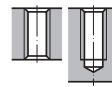

Einsatzgebiete – Material
Applications – material

» 22

Werkzeug-Ident · Tool ident

Nenngröße Nom. size	Ø d ₁	Ø d ₁ mm	P Gg/1" (tpi)	l ₁	l ₂	Ø d ₂	□	Dimens.- Ident	Werkzeug-Ident	
									Robust 2X-VA NE2	Robust 2X-VA TIN
G 1"	33,25	11	160	30	25	20	30,75	.4042	●	○
1 1/4"	41,91	11	170	30	32	24	39,5	.4044	●	○
1 1/2"	47,80	11	190	32	36	29	45,25	.4046	●	○
1 3/4"	53,75	11	190	32	40	32	51	.4048	●	○
2"	59,61	11	220	40	45	35	57	.4050	●	○
2 1/4"	65,71	11	275	45	50	39	63,3	.4051	●	○
2 1/2"	75,18	11	275	45	50	39	72,8	.4053	●	○
2 3/4"	81,53	11	325	50	50	39	79,1	.4054	●	○
3"	87,88	11	325	50	50	39	85,5	.4055	●	○

2) Bevorzugt mit Pastenschmierung einsetzen, neben Werkzeug auch Bohrungswandung einstreichen.
Ölschmierung ist nur bei senkrechter Grundlochbearbeitung möglich, wenn das Grundloch mit Öl vollgefüllt ist.
If possible, use paste lubrication, coating both the tool and the walls of the drilled hole.
Lubrication with oil is possible only in the vertical machining of blind holes, if the hole is entirely filled with oil.

≥ G2" Schaft mit Griffrielen!
≥ G2" Shank with grooves for better handling!

Product Finder

- Vc
- M
- MF
- UNC UN-8
- UNF UNEF
- G, Rp NPSM, NPSF
- NPT, NPTF Rc, W
- BSW, BSF
- Pg
- MJ UNJC, UNJF
- EG (ST) SELF-LOCK
- Tr, Tr-F Rd
- Zubehör Accessories
- Tech. Info



- Product Finder
- V_c
- M
- MF
- UNC UN-8
- UNF UNEF
- G Rp NPSM, NPSF
- NPT, NPTF Rc, W
- BSW, BSF
- Pg
- MJ UNJC, UNJF
- EG (STI) SELF-LOCK
- Tr, Tr-F Rd
- Zubehör Accessories
- Tech. Info

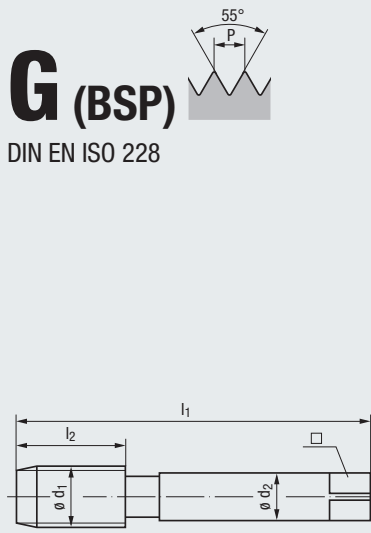

DIN 5157

STEEL
Steel materials



Toleranz · Tolerance
Beschichtung · Coating
Schneidstoff · Cutting material

- „X“
- HSSE
- C / 2-3
- E / 0

Technische Informationen
Technical information

» 245 - 266



Gewindetiefe und Lochform
Thread depth and hole type

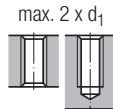

Einsatzgebiete – Material
Applications – material

» 22

- P 1.1-3.1
- N 2.3

Werkzeug-Ident · Tool ident

A0101001

Nenngröße Nom. size									Dimens.- Ident	Rekord A-STEEL
Ø d ₁	Ø d ₁ mm	P Gg/1" (tpi)	l ₁	l ₂	Ø d ₂	□				
G 1/16	7,72	28	63	17	6	4,9	6,8	.4034	○	
1/8	9,73	28	63	18	7	5,5	8,8	.4035	●	
1/4	13,16	19	70	20	11	9	11,8	.4036	●	
3/8	16,66	19	70	20	12	9	15,25	.4037	●	
1/2	20,96	14	80	22	16	12	19	.4038	●	
5/8	22,91	14	80	22	18	14,5	21	.4039	○	
3/4	26,44	14	90	22	20	16	24,5	.4040	●	
7/8	30,20	14	90	22	22	18	28,25	.4041	○	
1"	33,25	11	100	25	25	20	30,75	.4042	○	
1 1/8	37,90	11	125	30	28	22	35,5	.4043	○	
1 1/4	41,91	11	125	30	32	24	39,5	.4044	○	
1 3/8	44,32	11	125	30	36	29	41,75	.4045	○	
1 1/2	47,80	11	140	30	36	29	45,25	.4046	○	
1 3/4	53,75	11	140	32	40	32	51	.4048	○	
2"	59,61	11	160	36	45	35	57	.4050	○	

≈ DIN 371

DIN 5156 168

G (BSP)

DIN EN ISO 228

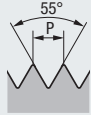

DIN 5157

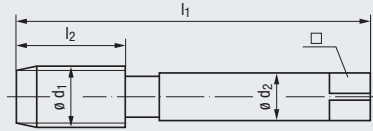

Technische Informationen
Technical information

» 245 - 266

Toleranz · Tolerance
Beschichtung · Coating
Schneidstoff · Cutting material



	„X“	„X“
HSSE	HSSE	HSSE
D / 3-4	C / 2-3	C / 2-3
O / P	O / P	O / P

Gewindetiefe und Lochform
Thread depth and hole type

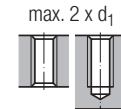
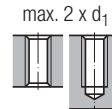

P 1.1-3.1 P 1.1-3.1 P 1.1-3.1

Einsatzgebiete – Material
Applications – material

» 22

Werkzeug-Ident · Tool ident

Nenngröße Nom. size	Ø d ₁ mm	P Gg/1" (tpi)	l ₁	l ₂	Ø d ₂	□	Ø	Dimens.- Ident	H0211009	H0211001	H0201001
									HGB-Set V-Nr.1	HGB-Set F	HGB-Set 2S (Nr.1, F)
G 1/16	7,72	28	63	17	6	4,9	6,8	.4034	●	●	●
1/8	9,73	28	63	18	7	5,5	8,8	.4035	●	●	●
1/4	13,16	19	70	20	11	9	11,8	.4036	●	●	●
3/8	16,66	19	70	20	12	9	15,25	.4037	●	●	●
1/2	20,96	14	80	22	16	12	19	.4038	●	●	●
5/8	22,91	14	80	22	18	14,5	21	.4039	○	○	○
3/4	26,44	14	90	22	20	16	24,5	.4040	●	●	●
7/8	30,20	14	90	22	22	18	28,25	.4041	○	○	○
1"	33,25	11	100	25	25	20	30,75	.4042	○	○	○
1 1/8	37,90	11	125	30	28	22	35,5	.4043	○	○	○
1 1/4	41,91	11	125	30	32	24	39,5	.4044	○	○	○
1 3/8	44,32	11	125	30	36	29	41,75	.4045	○	○	○
1 1/2	47,80	11	140	30	36	29	45,25	.4046	○	○	○
1 3/4	53,75	11	140	32	40	32	51	.4048	○	○	○
2"	59,61	11	160	36	45	35	57	.4050	○	○	○

- Product Finder
- V_c
- M
- MF
- UNC UN-8
- UNF UNEF
- G, Rp NPSM, NPSF
- NPT, NPTF Rc, W
- BSW, BSF
- Pg
- MJ UNJC, UNJF
- EG (STI) SELF-LOCK
- Tr, Tr-F Rd
- Zubehör Accessories
- Tech. Info



Verstellbare Windeisen siehe Seite 243

Adjustable tap wrenches, see page 243

- Product Finder
- Vc
- M
- MF
- UNC UN-8
- UNF UNEF
- G Rp NPSM, NPSF
- NPT, NPTF Rc, W
- BSW, BSF
- Pg
- MJ UNJC, UNJF
- EG (STI) SELF-LOCK
- Tr, Tr-F Rd
- Zubehör Accessories
- Tech. Info



DIN EN ISO 228

DIN 5157

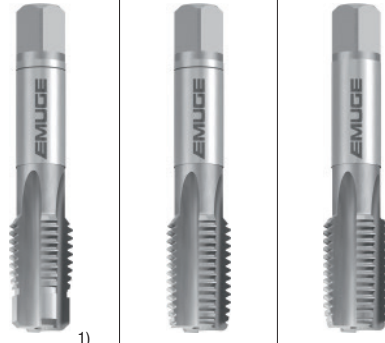
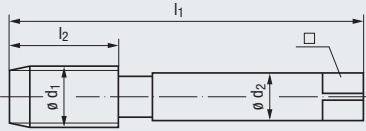

Toleranz · Tolerance
Beschichtung · Coating
Schneidstoff · Cutting material

Technische Informationen
Technical information

» 245 - 266



HSSE	HSSE	HSSE
C / 2-3	C / 2-3	C / 2-3
O / P	O / P	O / P

„X“

Gewindetiefe und Lochform
Thread depth and hole type

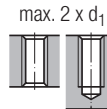

Einsatzgebiete – Material
Applications – material

» 22

P 1.1-5.1	P 1.1-5.1	P 1.1-5.1
M 1.1-4.1	M 1.1-4.1	M 1.1-4.1
S 2.1-2, 2.4	S 2.1-2, 2.4	S 2.1-2, 2.4

Werkzeug-Ident · Tool ident

H0463009 H0473009 H0473001

Nenngröße Nom. size	Ø d ₁	Ø d ₁ mm	P Gg/1" (tpi)	l ₁	l ₂	Ø d ₂	□	Dimens.- Ident	WM-Set	WM-Set	WM-Set
									V-Nr.1Z	V-Nr.1	F
G 1/8	9,73	28	63	18	7	5,5	8,8	.4035	●	●	●
1/4	13,16	19	70	20	11	9	11,8	.4036	●	●	●
3/8	16,66	19	70	20	12	9	15,25	.4037	●	●	●
1/2	20,96	14	80	22	16	12	19	.4038	●	●	●
5/8	22,91	14	80	22	18	14,5	21	.4039	●	●	●
3/4	26,44	14	90	22	20	16	24,5	.4040	●	●	●
1"	33,25	11	100	25	25	20	30,75	.4042	○	○	○

1) Der Vorschneider Nr.1Z mit Führungszapfen ist eine zusätzliche Hilfe zum winkelrechten Anschneiden von Hand. Er kann z.B. auf der Maschine weggelassen werden. Die Profilabstufung von Nr.1Z und Nr.1 ist gleich.
The taper tap No. 1Z with cylindrical pilot is an additional aid for true alignment especially when tapping by hand. It can be deleted when tapping by machine. The profile graduation of No.1Z, and No.1 is the same.

Product Finder

V_C

M

MF

UNC
UN-8

UNF
UNEF

G, Rp
NPSM, NPSF

NPT, NPTF
Rc, W

BSW, BSF

Pg

MJ
UNJC, UNJF

EG (STI)
SELF-LOCK

Tr, Tr-F
Rd

Zubehör
Accessories

Tech. Info

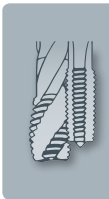

<p>2)</p>			
<p>„X“</p> <p>HSSE</p> <p>C / 2-3</p> <p>O / P</p>	<p>„X“</p> <p>HSSE</p> <p>C / 2-3</p> <p>O / P</p>		
<p>max. 2 x d₁</p>			
<p>P 1.1-5.1</p> <p>M 1.1-4.1</p> <p>S 2.1-2, 2.4</p>	<p>P 1.1-5.1</p> <p>M 1.1-4.1</p> <p>S 2.1-2, 2.4</p>		
<p>H0453001</p> <p>WM-Set</p> <p>3S</p> <p>(Nr.1Z, Nr.1, F)</p>	<p>H0483001</p> <p>WM-Set</p> <p>2S</p> <p>(Nr.1, F)</p>		
<p>●</p> <p>●</p> <p>●</p> <p>●</p> <p>●</p> <p>○</p>	<p>●</p> <p>●</p> <p>●</p> <p>●</p> <p>●</p> <p>○</p>		<p>G 1/8 - 28</p> <p>1/4 - 19</p> <p>3/8 - 19</p> <p>1/2 - 14</p> <p>5/8 - 14</p> <p>3/4 - 14</p> <p>1" - 11</p>

2) Beim Gewindebohren von Hand in Durchgangslöcher entfällt Nr.1
No.1 is not needed when tapping in through holes by hand

- Product Finder
- V_c
- M
- MF
- UNC UN-8
- UNF UNEF
- G Rp NPSM, NPSF
- NPT, NPTF Rc, W
- BSW, BSF
- Pg
- MJ UNJC, UNJF
- EG (STI) SELF-LOCK
- Tr, Tr-F Rd
- Zubehör Accessories
- Tech. Info



DIN EN ISO 228

≈ DIN 5157

Für dünnwandige Messing-Rohre
For thin-walled brass tubes

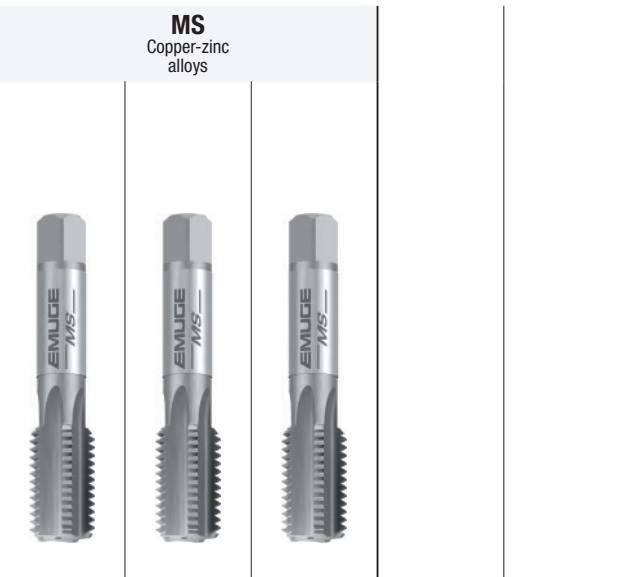
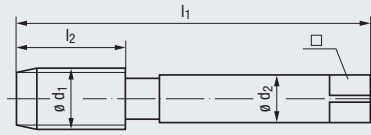

Technische Informationen Technical information ▶ 245 - 266	Toleranz · Tolerance	„X“	„X“ +0,05 2)	„X“ +0,1 2)
	Beschichtung · Coating	HSSE	HSSE	HSSE
	Schneidstoff · Cutting material	max. 1	max. 1	max. 1
		E	E	E
Gewindetiefe und Lochform Thread depth and hole type		max. 1 x d ₁ 		

Einsatzgebiete – Material Applications – material ▶ 22	N 2,3,2,6	N 2,3,2,6	N 2,3,2,6
--	-----------	-----------	-----------

Werkzeug-Ident · Tool ident										A6622501	A6622531	A662254A
Nenngröße Nom. size									Dimens.- Ident	AUT-A MS-R	AUT-A MS-R	AUT-A MS-R
Ø d ₁	Ø d ₁ mm	P Gg/1" (tpi)	l ₁	l ₂	Ø d ₂	□		„+0,05“		„+0,1“		
G 1/8	9,73	28	63	18	7	5,5	8,8	.4035	●	●	●	
1/4	13,16	19	70	20	10 1)	8	11,8	.4036	●	●	●	
3/8	16,66	19	70	20	12	9	15,25	.4037	●	●	●	
1/2	20,96	14	80	22	15 1)	12	19	.4038	●	●	●	
3/4	26,44	14	90	22	18 1)	14,5	24,5	.4040	●	●	●	
7/8	30,20	14	90	22	18 1)	14,5	28,25	.4041	●	●	●	
1"	33,25	11	100	25	18 1)	14,5	30,75	.4042	○	○	○	
1 1/8	37,90	11	125	30	18 1)	14,5	35,5	.4043	○	○	○	
1 1/4	41,91	11	125	30	18 1)	14,5	39,5	.4044	○	○	○	
1 3/8	44,32	11	125	30	18 1)	14,5	41,75	.4045	○	○	○	
1 1/2	47,80	11	140	30	18 1)	14,5	45,25	.4046	○	○	○	

1) Spezieller AUT-Schaft
Special shank for "AUT" taps

2) Vorbohrdurchmesser für Gewindebohrer mit Übermaß um 0,05 bzw. 0,1 mm anheben
Increase drill diameter for taps with oversize by 0.05 resp. 0.1 mm

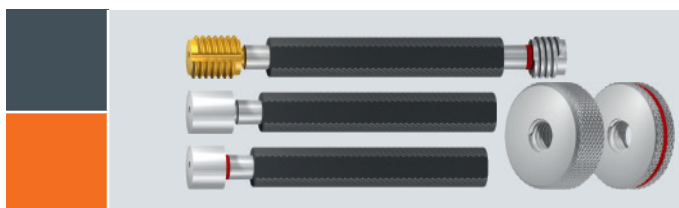

Gewindelehren
siehe Seite 581 - 654

Thread gauges,
see page 581 - 654

Rp (BSPP)

DIN EN 10226-1, ISO 7-1

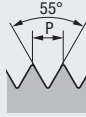

DIN 5156

STEEL
Steel materials

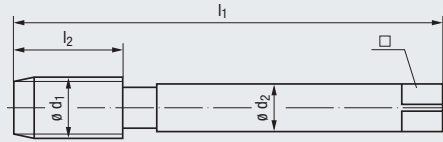

Technische Informationen
Technical information

» 245 - 266

Toleranz · Tolerance
Beschichtung · Coating
Schneidstoff · Cutting material



- „X“
- HSSE
- C / 2-3
- E / 0

Gewindetiefe und Lochform
Thread depth and hole type

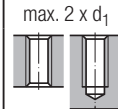

Einsatzgebiete – Material
Applications – material

» 22

- P 1.1-3.1
- N 2.3

Werkzeug-Ident · Tool ident

C0101001

Nenngröße
Nom. size

Rp	Ø d ₁	Ø d ₁ mm	P Gg/1" (tpi)	l ₁	l ₂	Ø d ₂	□	Image	Dimens.- Ident	Rekord 2A-STEEL			
										Ø d ₁	P	l ₁	l ₂
1/16	7,72	28	90	17	6	4,9	6,55	.4091	○				
1/8	9,73	28	90	18	7	5,5	8,6	.4092	●				
1/4	13,16	19	100	22	11	9	11,5	.4093	●				
3/8	16,66	19	100	22	12	9	15	.4094	●				
1/2	20,96	14	125	25	16	12	18,5	.4095	●				
3/4	26,44	14	140	28	20	16	24	.4096	●				
1"	33,25	11	160	30	25	20	30,25	.4097	●				

Zugehöriges Außengewinde ist kegelig, siehe Schneideisen Seite 493
The appropriate external thread is tapered, see dies, page 493

- Product Finder
- Vc
- M
- MF
- UNC UN-8
- UNF UNEF
- G Rp NPSM, NPSF
- NPT, NPTF Rc, W
- BSW, BSF
- Pg
- MJ UNJC, UNJF
- EG (ST) SELF-LOCK
- Tr, Tr-F Rd
- Zubehör Accessories
- Tech. Info



- Product Finder
- Vc
- M
- MF
- UNC UN-8
- UNF UNEF
- G, Rp NPSM, NPSF
- NPT, NPTF Rc, W
- BSW, BSF
- Pg
- MJ UNJC, UNJF
- EG (STI) SELF-LOCK
- Tr, Tr-F Rd
- Zubehör Accessories
- Tech. Info

Rp (BSPP)

DIN EN 10226-1, ISO 7-1



DIN 5156

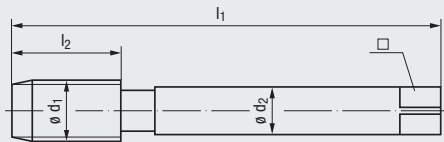

Z
CNC-controlled machines



Technische Informationen
Technical information

» 245 - 266

Toleranz · Tolerance
Beschichtung · Coating
Schneidstoff · Cutting material



- | | |
|-----------|-----------|
| HSSE | TIN |
| R45 | HSSE |
| E / 1,5-2 | R45 |
| E / O / P | E / 1,5-2 |
| | E / O / P |

Gewindetiefe und Lochform
Thread depth and hole type

max. 3 x d₁



Einsatzgebiete – Material
Applications – material

» 22

- | | |
|-----------|----------------|
| P 1.1-4.1 | P 1.1-4.1 |
| M 1.1-2.1 | M 1.1-3.1 |
| N 2.1 | N 1.4-6 |
| | N 2.1-2, 2.4-5 |
| | S 1.1 |

Werkzeug-Ident · Tool ident

C0513500 C0513700

Nenngröße Nom. size									Dimens.- Ident	Enorm 2-Z/E	Enorm 2-Z/E TIN
Ø d ₁	Ø d ₁ mm	P Gg/1" (tpi)	l ₁	l ₂	Ø d ₂	□					
Rp 1/16	7,72	28	90	10	6	4,9	6,55	.4091	○	○	
1/8	9,73	28	90	10	7	5,5	8,6	.4092	●	●	
1/4	13,16	19	100	15	11	9	11,5	.4093	●	●	
3/8	16,66	19	100	15	12	9	15	.4094	●	●	
1/2	20,96	14	125	17	16	12	18,5	.4095	●	●	
3/4	26,44	14	140	20	20	16	24	.4096	●	○	
1"	33,25	11	160	24	25	20	30,25	.4097	●	○	

Zugehöriges Außengewinde ist kegelig, siehe Schneideisen Seite 493
The appropriate external thread is tapered, see dies, page 493

Rp (BSPP)

DIN EN 10226-1, ISO 7-1

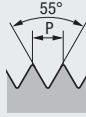

≈ DIN 352

Für dünnwandige Messing-Rohre
For thin-walled brass tubes

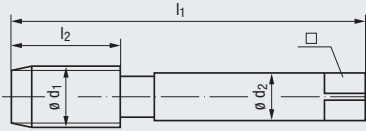

Technische Informationen
Technical information

» 245 - 266

Toleranz · Tolerance
Beschichtung · Coating
Schneidstoff · Cutting material



Gewindetiefe und Lochform
Thread depth and hole type

Einsatzgebiete – Material
Applications – material

» 22

Werkzeug-Ident · Tool ident

Nenngröße
Nom. size

Rp	Ø d ₁	Ø d ₁ mm	P Gg/1" (tpi)	l ₁	l ₂	Ø d ₂	□	Dimens.- Ident	A6622501		A6622531	
									AUT-A MS-R	AUT-A MS-R	AUT-A MS-R	AUT-A MS-R
1/8	9,73	28	63	18	7	5,5	8,6	.4092	○	○		
1/4	13,16	19	70	20	10 1)	8	11,5	.4093	○	○		
3/8	16,66	19	70	20	12	9	15	.4094	○	○		
1/2	20,96	14	80	22	15 1)	12	18,5	.4095	○	○		
3/4	26,44	14	90	22	18 1)	14,5	24	.4096	○	○		
1"	33,25	11	100	25	18 1)	14,5	30,25	.4097	○	○		

Zugehöriges Außengewinde ist kegelig, siehe Schneideisen Seite 493
The appropriate external thread is tapered, see dies, page 493

1) Spezieller AUT-Schaft

Special shank for "AUT" taps

2) Vorbohrdurchmesser für Gewindebohrer mit Übermaß um 0,05 anheben

Increase drill diameter for taps with oversize by 0.05 mm

MS
Copper-zinc
alloys



„X“ „X“ +0,05 2)

HSSE HSSE

max. 1 max. 1

E E

max. 1 x d₁

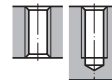

N 2,3,2,6 N 2,3,2,6

Product
Finder

V_c

M

MF

UNC
UN-8

UNF
UNEF

G Rp
NPSM, NPSF

NPT, NPTF
Rc, W

BSW, BSF

Pg

MJ
UNJC, UNJF

EG (STI)
SELF-LOCK

Tr, Tr-F
Rd

Zubehör
Accessories

Tech. Info



- Product Finder
- Vc
- M
- MF
- UNC UN-8
- UNF UNEF
- G, Rp NPSM NPSF
- NPT, NPTF Rc, W
- BSW, BSF
- Pg
- MJ UNJC, UNJF
- EG (STI) SELF-LOCK
- Tr, Tr-F Rd
- Zubehör Accessories
- Tech. Info

NPSM



≈ DIN 5156

ANSI B1.20.1

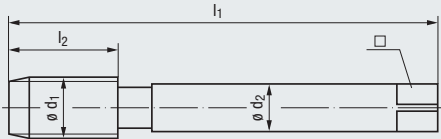

STEEL
Steel materials



Z
CNC-controlled machines



Technische Informationen
Technical information

» 245 - 266

Toleranz · Tolerance
Beschichtung · Coating
Schneidstoff · Cutting material



- „X“
- HSSE
- C / 2-3
- E / 0

- TIN
- HSSE
- R45
- E / 1,5-2**
- E / 0 / P

Gewindetiefe und Lochform
Thread depth and hole type

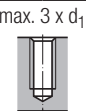
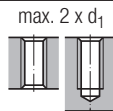

Einsatzgebiete – Material
Applications – material

» 22

- P 1.1-3.1
- N 2.3

- P 1.1-4.1
- M 1.1-2.1
- N 2.1
- N 1.4-6
- N 2.1-2, 2.4-5
- S 1.1

Werkzeug-Ident · Tool ident

C0101001

C0513500

C0513700

Nenngröße
Nom. size

Ø d ₁	Ø d ₁ mm	P Gg/1" (tpi)	l ₁	l ₂	Ø d ₂	□	Dimens.-Ident	
							NPSM	NPSC
1/8	10,100	27	90	18	7	5,5	9,1	8,8
1/4	13,404	18	100	22	11	9	12	11,4
3/8	16,843	18	100	22	12	9	15,5	14,9
1/2	20,949	14	125	25	16	12	19	18,4
3/4	26,296	14	140	28	20	16	24,5	23,7
1"	32,895	11 1/2	160	30	25	20	30,5	29,8

Rekord 2A-STEEL

Enorm 2-Z/E

Enorm 2-Z/E TIN

NPSM auch für NPSC verwendbar
NPSM can also be used for NPSC thread

NPSF

ANSI B1.20.3



≈ DIN 5156

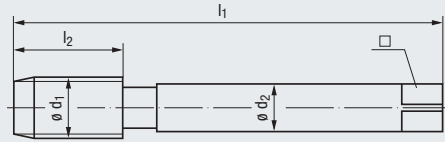

STEEL
Steel materials



Z
CNC-controlled machines



Product Finder

Vc

M

MF

UNC UN-8

UNF UNEF

G, Rp NPSM **NPSF**

NPT, NPTF Rc, W

BSW, BSF

Pg

MJ UNJC, UNJF

EG (ST) SELF-LOCK

Tr, Tr-F Rd

Zubehör Accessories

Tech. Info

Technische Informationen
Technical information

» 245 - 266

Toleranz · Tolerance
Beschichtung · Coating
Schneidstoff · Cutting material



„X“

HSSE

C / 2-3

E / O

TIN

HSSE

HSSE

R45

R45

E / 1,5-2

E / 1,5-2

E / O / P

E / O / P

Gewindetiefe und Lochform
Thread depth and hole type

max. 2 x d₁

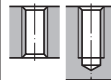

max. 3 x d₁



Einsatzgebiete – Material
Applications – material

» 22

P 1.1-3.1
N 2.3

P 1.1-4.1
M 1.1-2.1
N 2.1

P 1.1-4.1
M 1.1-3.1
N 1.4-6
N 2.1-2, 2.4-5
S 1.1

Werkzeug-Ident · Tool ident

C0101001

C0513500

C0513700

Nenngröße
Nom. size

Ø d ₁	Ø d ₁ mm	P Gg/1" (tpi)	l ₁	l ₂	Ø d ₂	□	Ø d ₁	Dimens.- Ident	Werkzeug-Ident · Tool ident		
									Rekord 2A-STEEL	Enorm 2-Z/E	Enorm 2-Z/E TIN
1/16	7,582	27	90	17	6	4,9	6,35	.5904	●	●	●
1/8	9,929	27	90	18	7	5,5	8,7	.5905	●	●	●
1/4	13,236	18	100	22	11	9	11,3	.5906	●	●	●
3/8	16,673	18	100	22	12	9	14,75	.5907	●	●	●
1/2	20,819	14	125	25	16	12	18,2	.5908	●	●	●
3/4	26,166	14	140	28	20	16	23,5	.5909	○	○	○
1"	32,718	11 1/2	160	30	25	20	29,5	.5910	○	○	○

- Product Finder
- Vc
- M
- MF
- UNC UN-8
- UNF UNEF
- G, Rp NPSM, NPSF
- NPT, NPTF Rc, R
- BSW, BSF
- Pg
- MJ UNJC, UNJF
- EG (STI) SELF-LOCK
- Tr, Tr-F Rd
- Zubehör Accessories
- Tech. Info



ANSI/ASME B1.20.1

a) Zylindrisch vorarbeiten
Cylindrical preparation of thread hole

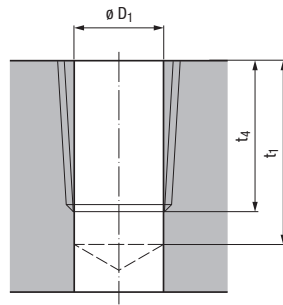

EMUGE NPT-Gewindebohrer sind für die Lochformen a) bis c) geeignet. Für Gewinde mit höheren Anforderungen, z.B. NPT-Gewinde für die Luftfahrt, empfehlen wir, das Kernloch nach Form b) bzw. c) auszuführen.

EMUGE NPT taps are suited for the hole forms a) to c). For threads with higher demands, e.g. NPT threads for the aircraft industry, we recommend preparing the thread hole to form b), resp. c).

Nenngröße Nom. size $\varnothing d_1$	P Gg/1" (tpi)	$\varnothing D_1$	t_1 1)	t_4
1/16	27	6,15	11,8	9,70
1/8	27	8,50	11,9	9,75
1/4	18	11,00	17,4	14,25
3/8	18	14,40	17,7	14,55
1/2	14	17,80	23,1	19,00
3/4	14	23,15	23,6	19,50
1"	11 1/2	29,05	28,4	23,40
1 1/4	11 1/2	37,80	28,9	23,90
1 1/2	11 1/2	43,85	28,9	23,90
2"	11 1/2	55,85	29,3	24,35

b) Kegelig vorarbeiten
Tapered preparation of thread hole

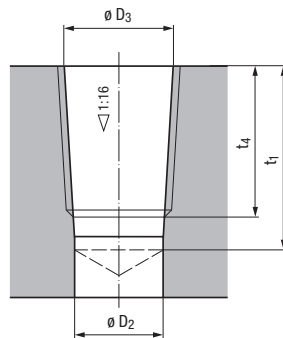

Nenngröße Nom. size $\varnothing d_1$	P Gg/1" (tpi)	$\varnothing D_2$	$\varnothing D_3$ +0,05	t_1 1)	t_4
1/16	27	5,95	6,39	11,8	9,70
1/8	27	8,30	8,74	11,9	9,75
1/4	18	10,75	11,36	17,4	14,25
3/8	18	14,15	14,80	17,7	14,55
1/2	14	17,45	18,32	23,1	19,00
3/4	14	22,80	23,67	23,6	19,50
1"	11 1/2	28,65	29,69	28,4	23,40
1 1/4	11 1/2	37,35	38,45	28,9	23,90
1 1/2	11 1/2	43,45	44,52	28,9	23,90
2"	11 1/2	55,45	56,56	29,3	24,35

1) Die Vorbohrtiefe t_1 berücksichtigt die Längen L_1 und L_3 nach ASME-Norm, sowie die Anschnittlänge des Gewindebohrers und 1 bis 2 Gewindegänge Sicherheit. Tiefbohren ist erforderlich, wenn Gewindebohrer mit Maximal-Gewindelängen nach ASME B94.9 angewendet werden sollen. The drill depth t_1 takes into account the lengths L_1 and L_3 acc. ASME standards, the chamfer length of the tap and 1-2 threads safety margin. Deep drilling is necessary whenever taps with maximum thread length acc. ASME B94.9 are to be used.

c) Vorarbeiten von Grundlöchern
Preparation of blind holes

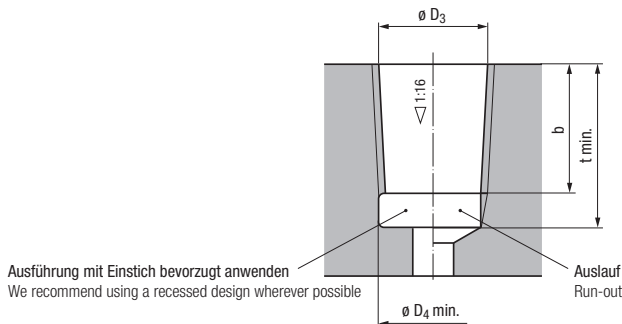

Nenngröße Nom. size $\varnothing d_1$	P Gg/1" (tpi)	$\varnothing D_3$ +0,05	b	t min. 2)	$\varnothing D_4$ min.
1/16	27	6,39	7,0	10,0	7,6
1/8	27	8,74	7,0	10,0	10,0
1/4	18	11,36	10,2	14,5	13,1
3/8	18	14,80	10,6	15,0	16,5
1/2	14	18,32	13,8	19,0	20,5
3/4	14	23,67	14,2	20,0	25,8
1"	11 1/2	29,69	17,0	24,0	32,2
1 1/4	11 1/2	38,45	17,5	24,5	41,0
1 1/2	11 1/2	44,52	17,5	24,5	47,2
2"	11 1/2	56,56	18,0	25,0	59,2

2) Die Kernlochmaße sind auf Minimalängen nach ASME-Norm aufgebaut. Für Grundlöcher, welche die angegebenen Mindestdiefen t nicht zulassen, sind Sondergewindebohrer erforderlich. Eine bemaßte Grundlochskizze ist zur Beurteilung notwendig. The thread hole dimensions are based on minimal lengths acc. ASME standards. For blind holes which do not permit the indicated minimal depth t , special taps are necessary. A thread hole sketch with full dimensional specifications is necessary for making a decision.

NPT



ANSI/ASME B1.20.1

≈ DIN 371

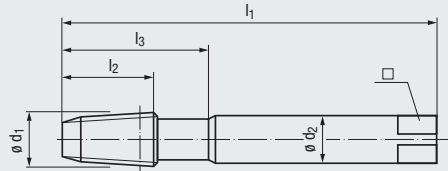

STEEL
Steel materials



VA
Stainless steel materials



Technische Informationen
Technical information

» 245 - 266

Toleranz · Tolerance
Beschichtung · Coating
Schneidstoff · Cutting material



HSSE

C / 2-3

E / O

HSSE

C / 2-3

E / O / P

HSSE

C / 2-3

E / O / P

Einsatzgebiete – Material
Applications – material

» 22

P 1.1-2.1
K 1.1-2
N 2.2-3

P 1.1-4.1
M 1.1-2.1
K 2.1-4.2
N 1.4-5, 2.4-6

P 1.1-4.1
M 1.1-3.1
K 2.1-4.2
N 2.4-6

Werkzeug-Ident · Tool ident

B0181000

B0183000

B0193000

Nenngröße Nom. size	P Gg/1" (tpi)	Dimens.-Ident					Rekord 1-KEG STEEL	Rekord 1-KEG VA	Rekord 1-KEG VA-AZ
		l_1	l_2	l_3	$\varnothing d_2$	\square			
1/16	27	90	12	26	8	6,2	●	●	
1/8	27	90	12	26	10	8	●	●	
1/4	18	100	18	34,5	14	11	●	●	
3/8	18	110	18	37,5	18	14,5			
1/2	14	140	23	45	22	18			

≈ DIN 374



» 187

» 187

» 187

≈ DIN 2181



» 189

Gewindekernloch-Vorfertigungsdurchmesser für NPT-Gewinde siehe Seite 184
Thread hole preparatory diameters for NPT threads, see page 184

Kegelige Gewindebohrer mit langer Gewindelänge nach ANSI B94.9 auf Anfrage
Tapered taps with long thread length acc. ANSI B94.9 upon request



Kegelreibahlen 1:16 für kegelige Gewinde
Taper reamers 1:16 for tapered threads

» 200

Product Finder

V_C

M

MF

UNC UN-8

UNF UNEF

G, Rp NPSM, NPSF

NPT NPTF Rc, W

BSW, BSF

Pg

MJ UNJC, UNJF

EG (ST) SELF-LOCK

Tr, Tr-F Rd

Zubehör Accessories

Tech. Info



- Product Finder
- Vc
- M
- MF
- UNC UN-8
- UNF UNEF
- G, Rp NPSM, NPSF
- NPT, NPTF Rc, W**
- BSW, BSF
- Pg
- MJ UNJC, UNJF
- EG (STI) SELF-LOCK
- Tr, Tr-F Rd
- Zubehör Accessories
- Tech. Info



NPT

ANSI/ASME B1.20.1

≈ DIN 371

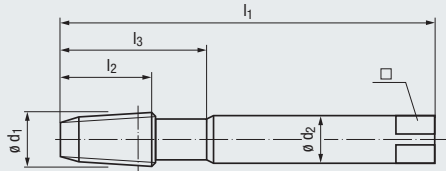

VA
Stainless steel materials



NI
Nickel alloys



Technische Informationen
Technical information

245 - 266

Toleranz · Tolerance
Beschichtung · Coating
Schneidstoff · Cutting material



HSSE	HSSE
R35	R35
C / 2-3	C / 2-3
E / O / P	E / O / P

TICN
HSSE-PM
R10
C / 2-3
O / P

Einsatzgebiete – Material
Applications – material

22

P 1.1-3.1	P 1.1-3.1
M 1.1-3.1	M 1.1-3.1

M 2.1-4.1
S 2.3, 2.5-6

Werkzeug-Ident · Tool ident

								B1583000	B1593000	B670J400
Nenngröße Nom. size								Rekord 1-KEG R35-VA	Rekord 1-KEG R35-VA-AZ	Rekord 1-KEG R10-NI PM-TICN
$\varnothing d_1$	P Gg/1" (tpi)	l_1	l_2	l_3	$\varnothing d_2$	\square	Dimens.-Ident			
1/16	27	90	12	26	8	6,2	.5763	●	●	
1/8	27	90	12	26	10	8	.5764	●	●	○
1/4	18	100	18	34,5	14	11	.5765	●	●	○
3/8	18	110	18	37,5	18	14,5	.5766			○
1/2	14	140	23	45	22	18	.5767			○
≈ DIN 374								188	188	
≈ DIN 2181										

Gewidekernloch-Vorfertigungsdurchmesser für NPT-Gewinde siehe Seite 184
Thread hole preparatory diameters for NPT threads, see page 184

Kegelige Gewindebohrer mit langer Gewindelänge nach ANSI B94.9 auf Anfrage
Tapered taps with long thread length acc. ANSI B94.9 upon request



Kegelreibahlen 1:16 für kegelige Gewinde
Taper reamers 1:16 for tapered threads

200



Schneideisen für kegelige
Außengewinde siehe Seite 491 - 493

Dies for external tapered threads,
see page 491 - 493

NPT



ANSI/ASME B1.20.1

≈ DIN 374

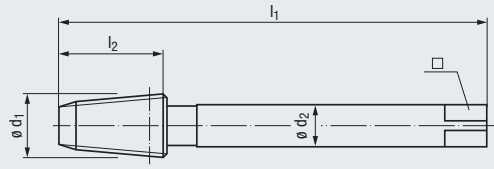

STEEL
Steel materials



VA
Stainless steel materials



Technische Informationen
Technical information

» 245 - 266

Toleranz · Tolerance
Beschichtung · Coating
Schneidstoff · Cutting material



HSSE	HSSE	HSSE
C / 2-3	C / 2-3	C / 2-3
E / 0	E / 0 / P	E / 0 / P

Einsatzgebiete – Material
Applications – material

» 22

P 1.1-2.1	P 1.1-4.1	P 1.1-4.1
K 1.1-2	M 1.1-2.1	M 1.1-3.1
N 2.2-3	K 2.1-4.2	K 2.1-4.2
	N 1.4-5, 2.4-6	N 2.4-6

Werkzeug-Ident · Tool ident

							C0181000	C0183000	C0193000
Nenngröße Nom. size							Rekord 2-KEG STEEL	Rekord 2-KEG VA	Rekord 2-KEG VA-AZ
Ø d ₁	P Gg/1" (tpi)	l ₁	l ₂	Ø d ₂	□	Dimens.- Ident			
3/8	18	110	18	14	11	.5766	●	●	
1/2	14	140	23	16	12	.5767	●	●	
3/4	14	150	24	20	16	.5768	●	●	
1"	11 1/2	170	30	25	20	.5769	●	●	
1 1/4	11 1/2	190	32	32	24	.5770	○		
1 1/2	11 1/2	200	32	36	29	.5771	○		
2"	11 1/2	220	34	45	35	.5772	○		
≈ DIN 371							» 185	» 185	» 185
≈ DIN 2181							» 189		

Gewindekernloch-Vorfertigungsdurchmesser für NPT-Gewinde siehe Seite 184
Thread hole preparatory diameters for NPT threads, see page 184

Kegelige Gewindebohrer mit langer Gewindelänge nach ANSI B94.9 auf Anfrage
Tapered taps with long thread length acc. ANSI B94.9 upon request

Kegelreibahlen 1:16 für kegelige Gewinde
Taper reamers 1:16 for tapered threads » 200

- Product Finder
- V_c
- M
- MF
- UNC UN-8
- UNF UNEF
- G, Rp NPSM, NPSF
- NPT NPTF Rc, W
- BSW, BSF
- Pg
- MJ UNJC, UNJF
- EG (ST) SELF-LOCK
- Tr, Tr-F Rd
- Zubehör Accessories
- Tech. Info



- Product Finder
- Vc
- M
- MF
- UNC UN-8
- UNF UNEF
- G, Rp NPSM, NPSF
- NPT, NPTF** Rc, W
- BSW, BSF
- Pg
- MJ UNJC, UNJF
- EG (STI) SELF-LOCK
- Tr, Tr-F Rd
- Zubehör Accessories
- Tech. Info



NPT

ANSI/ASME B1.20.1

≈ DIN 374

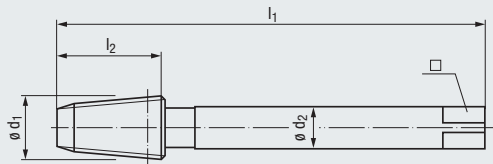

VA
Stainless steel materials



Technische Informationen
Technical information

245 - 266

Toleranz · Tolerance
Beschichtung · Coating
Schneidstoff · Cutting material



HSSE	HSSE
R35	R35
C / 2-3	C / 2-3
E / O / P	E / O / P

Einsatzgebiete – Material
Applications – material

22

P 1.1-3.1	P 1.1-3.1
M 1.1-3.1	M 1.1-3.1

Werkzeug-Ident · Tool ident

Nenngröße Nom. size							Dimens.- Ident	C1583000	C1593000
$\varnothing d_1$	P Gg/1" (tpi)	l_1	l_2	$\varnothing d_2$	\square	Rekord 2-KEG R35-VA		Rekord 2-KEG R35-VA-AZ	
3/8	18	110	18	14	11	.5766	●	●	
1/2	14	140	23	16	12	.5767	●	●	
3/4	14	150	24	20	16	.5768	●	●	
1"	11 1/2	170	30	25	20	.5769	●	●	
1 1/4	11 1/2	190	32	32	24	.5770	○	○	
1 1/2	11 1/2	200	32	36	29	.5771	○	○	
2"	11 1/2	220	34	45	35	.5772	○	○	

≈ DIN 371



186

186

≈ DIN 2181



Gewidekernloch-Vorfertigungsdurchmesser für NPT-Gewinde siehe Seite 184
Thread hole preparatory diameters for NPT threads, see page 184

Kegelige Gewindebohrer mit langer Gewindelänge nach ANSI B94.9 auf Anfrage
Tapered taps with long thread length acc. ANSI B94.9 upon request



Kegelreibahlen 1:16 für kegelige Gewinde
Taper reamers 1:16 for tapered threads

200

NPT



ANSI/ASME B1.20.1

≈ DIN 2181

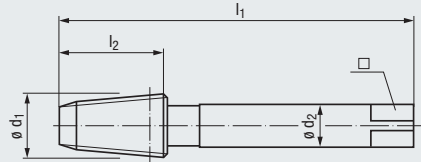

STEEL
Steel materials



Technische Informationen
Technical information

» 245 - 266

Toleranz · Tolerance
Beschichtung · Coating
Schneidstoff · Cutting material



HSSE	HSSE
C / 2-3	C / 2-3
E / 0	E / 0

Einsatzgebiete – Material
Applications – material

» 22

P 1.1-2.1	P 1.1-2.1
K 1.1-2	K 1.1-2
N 2.2-3	N 2.2-3

Werkzeug-Ident · Tool ident

Nenngröße
Nom. size

Dimens.-
Ident

A0181000
Rekord
KEG
STEEL

A0191000
Rekord
KEG
STEEL-AZ

ø d ₁	P Gg/1" (tpi)	l ₁	l ₂	ø d ₂	□	Dimens.- Ident	A0181000 Rekord KEG STEEL	A0191000 Rekord KEG STEEL-AZ
1/16	27	63	12	6	4,9	.5763	●	○
1/8	27	63	12	7	5,5	.5764	●	○
1/4	18	63	18	11	9	.5765	●	●
3/8	18	70	18	12	9	.5766	●	●
1/2	14	80	23	16	12	.5767	●	●
3/4	14	100	24	20	16	.5768	●	●
1"	11 1/2	110	30	25	20	.5769	●	○
1 1/4	11 1/2	125	32	32	24	.5770	○	○
1 1/2	11 1/2	140	32	36	29	.5771	○	○
2"	11 1/2	160	34	45	35	.5772	○	○

≈ DIN 371

» 185

≈ DIN 374

» 187

Gewindekernloch-Vorfertigungsdurchmesser für NPT-Gewinde siehe Seite 184
Thread hole preparatory diameters for NPT threads, see page 184

Kegelige Gewindebohrer mit langer Gewindelänge nach ANSI B94.9 auf Anfrage
Tapered taps with long thread length acc. ANSI B94.9 upon request



Kegelreibahlen 1:16 für kegelige Gewinde
Taper reamers 1:16 for tapered threads

» 200

Product
Finder

V_c

M

MF

UNC
UN-8

UNF
UNEF

G, Rp
NPSM, NPSF

NPT NPTF
Rc, W

BSW, BSF

Pg

MJ
UNJC, UNJF

EG (STI)
SELF-LOCK

Tr, Tr-F
Rd

Zubehör
Accessories

Tech. Info



- Product Finder
- Vc
- M
- MF
- UNC UN-8
- UNF UNEF
- G, Rp NPSM, NPSF
- NPT, NPTF Rc, W
- BSW, BSF
- Pg
- MJ UNJC, UNJF
- EG (STI) SELF-LOCK
- Tr, Tr-F Rd
- Zubehör Accessories
- Tech. Info

NPTF

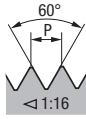

ANSI B1.20.3

a) Zylindrisch vorarbeiten Cylindrical preparation of thread hole

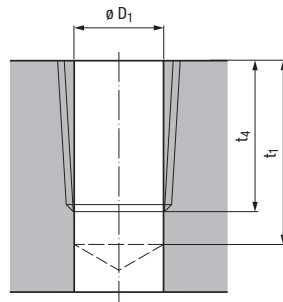

EMUGE NPTF-Gewindebohrer sind für die Lochformen a) bis c) geeignet. Für Gewinde mit höheren Anforderungen, z.B. NPTF-Gewinde für die Luftfahrt, empfehlen wir, das Kernloch nach Form b) bzw. c) auszuführen.

EMUGE NPTF taps are suited for the hole forms a) to c). For threads with higher demands, e.g. NPTF threads for the aircraft industry, we recommend preparing the thread hole to form b), resp. c).

Nenngröße Nom. size $\varnothing d_1$	P Gg/1" (tpi)	$\varnothing D_1$	t_1 1)	t_4
1/16	27	6,10	13,0	10,65
1/8	27	8,45	13,0	10,70
1/4	18	10,90	19,2	15,65
3/8	18	14,30	19,5	16,00
1/2	14	17,60	25,4	20,85
3/4	14	23,00	25,9	21,30
1"	11 1/2	28,75	31,1	25,60
1 1/4	11 1/2	37,50	31,7	26,15
1 1/2	11 1/2	43,75	31,7	26,15
2"	11 1/2	55,75	32,1	26,55

b) Kegelig vorarbeiten Tapered preparation of thread hole

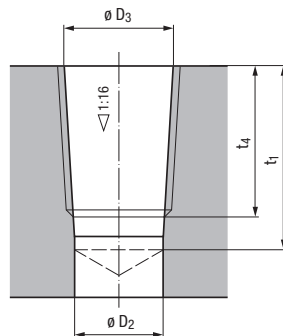

Nenngröße Nom. size $\varnothing d_1$	P Gg/1" (tpi)	$\varnothing D_2$	$\varnothing D_3$ +0,05	t_1 1)	t_4
1/16	27	5,95	6,41	13,0	10,65
1/8	27	8,30	8,76	13,0	10,70
1/4	18	10,75	11,40	19,2	15,65
3/8	18	14,15	14,84	19,5	16,00
1/2	14	17,45	18,33	25,4	20,85
3/4	14	22,80	23,68	25,9	21,30
1"	11 1/2	28,65	29,72	31,1	25,60
1 1/4	11 1/2	37,35	38,48	31,7	26,15
1 1/2	11 1/2	43,45	44,55	31,7	26,15
2"	11 1/2	55,45	56,59	32,1	26,55

1) Die Vorbohrtiefe t_1 berücksichtigt die Längen L_1 und L_3 nach ASME-Norm, sowie die Anschnittlänge des Gewindebohrers und 1 bis 2 Gewindegänge Sicherheit. Tiefbohren ist erforderlich, wenn Gewindebohrer mit Maximal-Gewindelängen nach ASME B94.9 angewendet werden sollen.
The drill depth t_1 takes into account the lengths L_1 and L_3 acc. ASME standards, the chamfer length of the tap and 1-2 threads safety margin.
Deep drilling is necessary whenever taps with maximum thread length acc. ASME B94.9 are to be used.

c) Vorarbeiten von Grundlöchern Preparation of blind holes

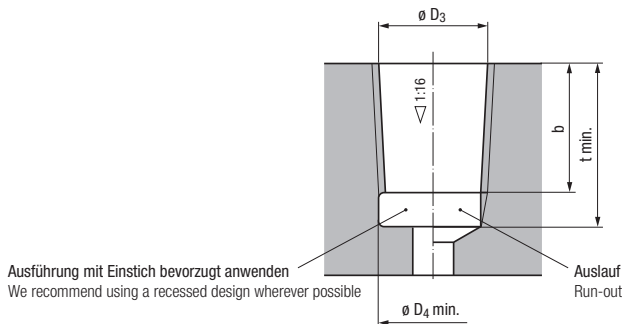

Nenngröße Nom. size $\varnothing d_1$	P Gg/1" (tpi)	$\varnothing D_3$ +0,05	b	t min. 2)	$\varnothing D_4$ min.
1/16	27	6,41	8,0	11,0	7,4
1/8	27	8,76	8,0	11,0	9,8
1/4	18	11,40	11,6	15,5	12,9
3/8	18	14,84	12,0	16,0	16,3
1/2	14	18,33	15,6	20,5	20,3
3/4	14	23,68	16,0	21,5	25,6
1"	11 1/2	29,72	19,2	26,0	32,0
1 1/4	11 1/2	38,48	19,7	26,5	40,8
1 1/2	11 1/2	44,55	19,7	26,5	47,0
2"	11 1/2	56,59	20,2	27,0	59,0

2) Die Kernlochmaße sind auf Minimallängen nach ASME-Norm aufgebaut. Für Grundlöcher, welche die angegebenen Mindestdiefen t nicht zulassen, sind Sondergewindebohrer erforderlich. Eine bemaßte Grundlochskizze ist zur Beurteilung notwendig.
The thread hole dimensions are based on minimal lengths acc. ASME standards. For blind holes which do not permit the indicated minimal depth t , special taps are necessary. A thread hole sketch with full dimensional specifications is necessary for making a decision.

NPTF

ANSI B1.20.3



≈ DIN 371

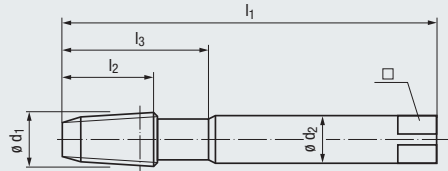

STEEL
Steel materials



VA
Stainless steel materials



NI
Nickel alloys



Product Finder

Vc

M

MF

UNC UN-8

UNF UNEF

G, Rp NPSM, NPSF

NPT, NPTF Rc, W

BSW, BSF

Pg

MJ UNJC, UNJF

EG (ST) SELF-LOCK

Tr, Tr-F Rd

Zubehör Accessories

Tech. Info

Toleranz · Tolerance
Beschichtung · Coating
Schneidstoff · Cutting material

Technische Informationen
Technical information ▶▶ 245 - 266



HSSE

C / 2-3

E / 0

HSSE

C / 2-3

E / 0 / P

HSSE

R35

C / 2-3

E / 0 / P

TICN

HSSE-PM

R10

C / 2-3

O / P

Einsatzgebiete – Material
Applications – material ▶▶ 22

P 1.1-2.1

K 1.1-2

N 2.2-3

P 1.1-4.1

M 1.1-2.1

K 2.1-4.2

N 1.4-5, 2.4-6

P 1.1-3.1

M 1.1-3.1

M 2.1-4.1

S 2.3, 2.5-6

Werkzeug-Ident · Tool ident

Nenngröße Nom. size								Dimens.- Ident	B0181000		B0183000	B1583000		B670J400
$\varnothing d_1$	P Gg/1" (tpi)	l_1	l_2	l_3	$\varnothing d_2$	\square		Rekord 1-KEG STEEL		Rekord 1-KEG VA	Rekord 1-KEG R35-VA		Rekord 1-KEG R10-NI PM-TICN	
1/16	27	90	12	26	8	6,2	.5782	●		●	●			
1/8	27	90	12	26	10	8	.5783	●		●	●		○	
1/4	18	100	18	34,5	14	11	.5784	●		●	●		○	
3/8	18	110	18	37,5	18	14,5	.5785						○	
1/2	14	140	23	45	22	18	.5786						○	
≈ DIN 374									192		192	192		
≈ DIN 2181									193					

Gewindekernloch-Vorfertigungsdurchmesser für NPTF-Gewinde siehe Seite 190
Thread hole preparatory diameters for NPTF threads, see page 190

Kegelige Gewindebohrer mit langer Gewindelänge nach ANSI B94.9 auf Anfrage
Tapered taps with long thread length acc. ANSI B94.9 upon request



Kegelreibahlen 1:16 für kegelige Gewinde ▶▶ 200
Taper reamers 1:16 for tapered threads

- Product Finder
- V_c
- M
- MF
- UNC UN-8
- UNF UNEF
- G, Rp NPSM, NPSF
- NPT NPTF Rc, W
- BSW, BSF
- Pg
- MJ UNJC, UNJF
- EG (STI) SELF-LOCK
- Tr, Tr-F Rd
- Zubehör Accessories
- Tech. Info

NPTF



≈ DIN 374

ANSI B1.20.3

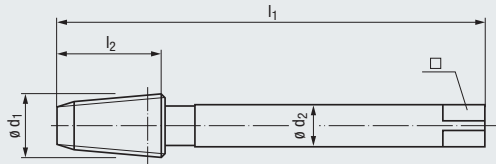

STEEL
Steel materials



VA
Stainless steel materials



Technische Informationen
Technical information

» 245 - 266

Toleranz · Tolerance
Beschichtung · Coating
Schneidstoff · Cutting material



HSSE

C / 2-3

E / O

HSSE

C / 2-3

E / O / P

HSSE

R35

C / 2-3

E / O / P

Einsatzgebiete – Material
Applications – material

» 22

- P 1.1-2.1
- K 1.1-2
- N 2.2-3

- P 1.1-4.1
- M 1.1-2.1
- K 2.1-4.2
- N 1.4-5, 2.4-6

- P 1.1-3.1
- M 1.1-3.1

Werkzeug-Ident · Tool ident

Nenngröße Nom. size							Dimens.- Ident	C0181000	C0183000	C1583000
Ø d ₁	P Gg/1" (tpi)	l ₁	l ₂	Ø d ₂	□	Rekord 2-KEG STEEL		Rekord 2-KEG VA	Rekord 2-KEG R35-VA	
3/8	18	110	18	14	11	.5785	●	●	●	
1/2	14	140	23	16	12	.5786	●	●	●	
3/4	14	150	24	20	16	.5787	●	●	●	
1"	11 1/2	170	30	25	20	.5788	○	○	○	
1 1/4	11 1/2	190	32	32	24	.5789	○	○	○	
1 1/2	11 1/2	200	32	36	29	.5790	○	○	○	
2"	11 1/2	220	34	45	35	.5791	○	○	○	

≈ DIN 371



» 191

» 191

» 191

≈ DIN 2181



» 193

Gewindekernloch-Vorfertigungsdurchmesser für NPTF-Gewinde siehe Seite 190
Thread hole preparatory diameters for NPTF threads, see page 190

Kegelige Gewindebohrer mit langer Gewindelänge nach ANSI B94.9 auf Anfrage
Tapered taps with long thread length acc. ANSI B94.9 upon request



Kegelreibahlen 1:16 für kegelige Gewinde
Taper reamers 1:16 for tapered threads

» 200

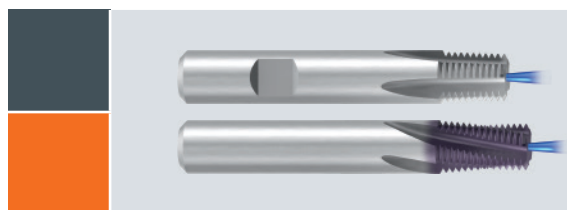

Gewindefräser für kegelige Gewinde
Typ GF-KEG siehe Seite 399 - 412

Thread milling cutters for tapered threads
type GF-KEG, see page 399 - 412

NPTF

ANSI B1.20.3



≈ DIN 2181

STEEL
Steel materials

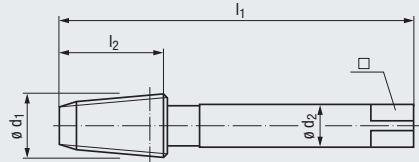

Technische Informationen
Technical information

» 245 - 266

Toleranz · Tolerance
Beschichtung · Coating
Schneidstoff · Cutting material



HSSE

C / 2-3

E / 0

Einsatzgebiete – Material
Applications – material

» 22

P 1.1-2.1

K 1.1-2

N 2.2-3

Werkzeug-Ident · Tool ident

A0181000

Nenngröße
Nom. size

Dimens.-
Ident

Rekord
KEG
STEEL

$\varnothing d_1$	P Gg/1" (tpi)	l_1	l_2	$\varnothing d_2$	\square	Dimens.- Ident	Rekord KEG STEEL
1/16	27	63	12	6	4,9	.5782	●
1/8	27	63	12	7	5,5	.5783	●
1/4	18	63	18	11	9	.5784	●
3/8	18	70	18	12	9	.5785	●
1/2	14	80	23	16	12	.5786	●
3/4	14	100	24	20	16	.5787	●
1"	11 1/2	110	30	25	20	.5788	○
1 1/4	11 1/2	125	32	32	24	.5789	○
1 1/2	11 1/2	140	32	36	29	.5790	○
2"	11 1/2	160	34	45	35	.5791	○

≈ DIN 371



» 191

≈ DIN 374



» 192

Gewindekernloch-Vorfertigungsdurchmesser für NPTF-Gewinde siehe Seite 190
Thread hole preparatory diameters for NPTF threads, see page 190

Kegelige Gewindebohrer mit langer Gewindelänge nach ANSI B94.9 auf Anfrage
Tapered taps with long thread length acc. ANSI B94.9 upon request



Kegelreibahlen 1:16 für kegelige Gewinde
Taper reamers 1:16 for tapered threads

» 200

Product
Finder

Vc

M

MF

UNC
UN-8

UNF
UNEF

G, Rp
NPSM, NPSF

NPT, NPTF
Rc, W

BSW, BSF

Pg

MJ
UNJC, UNJF

EG (STI)
SELF-LOCK

Tr, Tr-F
Rd

Zubehör
Accessories

Tech. Info



- Product Finder
- Vc
- M
- MF
- UNC UN-8
- UNF UNEF
- G, Rp NPSM, NPSF
- NPT, NPTF Rc, W
- BSW, BSF
- Pg
- MJ UNJC, UNJF
- EG (STI) SELF-LOCK
- Tr, Tr-F Rd
- Zubehör Accessories
- Tech. Info

Rc (BSPT)

DIN EN 10226-2, ISO 7-1



EMUGE Rc-Gewindebohrer sind für die Lochformen a) bis c) geeignet. Die Lochform a) kann angewendet werden, wenn keine Dichtprobleme zu befürchten sind.

EMUGE Rc taps are suited for the hole forms a) to c). Hole type a) can be used when there is no reason to worry about sealing problems.

a) Zylindrisch vorarbeiten
Cylindrical preparation of thread hole

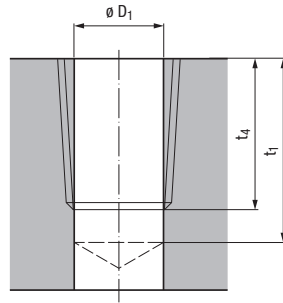

Nenngröße Nom. size $\varnothing d_1$	P Gg/1" (tpi)	$\varnothing D_1$	t_1	t_4
Rc 1/16	28	6,15	11,1	9,5
1/8	28	8,15	11,1	9,5
1/4	19	10,85	16,3	14,0
3/8	19	14,30	16,7	14,4
1/2	14	17,80	22,3	19,1
3/4	14	23,20	23,6	20,4
1"	11	29,20	28,3	24,3

b) Kegelig vorarbeiten
Tapered preparation of thread hole

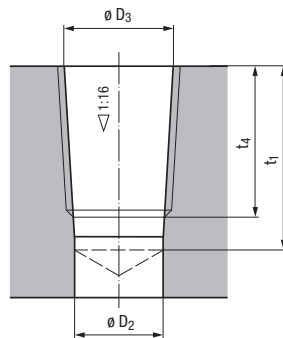

Nenngröße Nom. size $\varnothing d_1$	P Gg/1" (tpi)	$\varnothing D_2$	$\varnothing D_3$ JS11	t_1	t_4
Rc 1/16	28	6,10	6,56	11,1	9,5
1/8	28	8,10	8,57	11,1	9,5
1/4	19	10,75	11,45	16,3	14,0
3/8	19	14,25	14,95	16,7	14,4
1/2	14	17,70	18,63	22,3	19,1
3/4	14	23,10	24,12	23,6	20,4
1"	11	29,10	30,29	28,3	24,3

c) Vorarbeiten von Grundlöchern
Preparation of blind holes

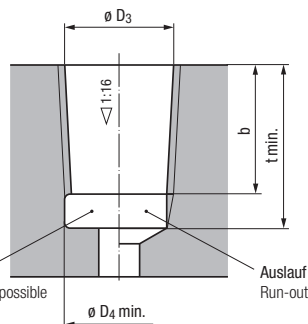

Ausführung mit Einstich bevorzugt anwenden
We recommend using a recessed design wherever possible

Auslauf
Run-out

Nenngröße Nom. size $\varnothing d_1$	P Gg/1" (tpi)	$\varnothing D_3$ JS11	b	t min. ²⁾	$\varnothing D_4$ min.
Rc 1/16	28	6,56	5,6	9,9	7,6 ^{+0,3}
1/8	28	8,57	5,6	9,9	9,6 ^{+0,3}
1/4	19	11,45	8,4	14,6	13,0 ^{+0,5}
3/8	19	14,95	8,8	15,0	16,5 ^{+0,5}
1/2	14	18,63	11,4	20,0	20,6 ^{+0,5}
3/4	14	24,12	12,7	21,3	26,0 ^{+0,5}
1"	11	30,29	14,5	25,4	32,8 ^{+0,5}

2) Für Grundlöcher, welche die angegebenen Mindesttiefen t nicht zulassen, sind Sondergewindebohrer erforderlich. Eine bemaßte Grundlochskizze ist zur Beurteilung notwendig.
For blind holes which do not permit the indicated minimal depth t, special taps are necessary. A thread hole sketch with full dimensional specifications is necessary for making a decision.

Rc (BSPT)

DIN EN 10226-2, ISO 7-1



≈ DIN 371

VA
Stainless steel materials

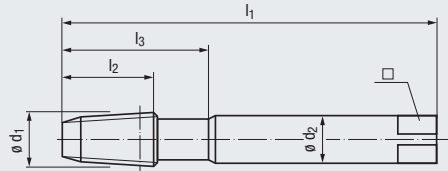

Technische Informationen
Technical information

» 245 - 266

Toleranz · Tolerance
Beschichtung · Coating
Schneidstoff · Cutting material



HSSE

C / 2-3

E / O / P

Einsatzgebiete – Material
Applications – material

» 22

- P** 1.1-4.1
- M** 1.1-2.1
- K** 2.1-4.2
- N** 1.4-5, 2.4-6

Werkzeug-Ident · Tool ident

B0183000

Nenngröße Nom. size	P Gg/1" (tpi)	l ₁	l ₂	l ₃	ø d ₂	□	Dimens.- Ident	Rekord 1-KEG VA					
									ø d ₁	ø d ₂	□		
Rc 1/8	28	90	12	26	10	8	.4115	●					
1/4	19	100	18	34,5	14	11	.4116	●					
≈ DIN 374								196					

Gewindekernloch-Vorfertigungsdurchmesser für Rc-Gewinde siehe Seite 194
Thread hole preparatory diameters for Rc threads, see page 194



Kegelreibahlen 1:16 für kegelige Gewinde
Taper reamers 1:16 for tapered threads

» 200

- Product Finder
- Vc
- M
- MF
- UNC UN-8
- UNF UNEF
- G, Rp NPSM, NPSF
- NPT, NPTF Rc W
- BSW, BSF
- Pg
- MJ UNJC, UNJF
- EG (STI) SELF-LOCK
- Tr, Tr-F Rd
- Zubehör Accessories
- Tech. Info



- Product Finder
- Vc
- M
- MF
- UNC UN-8
- UNF UNEF
- G, Rp NPSM, NPSF
- NPT, NPTF Rc W
- BSW, BSF
- Pg
- MJ UNJC, UNJF
- EG (STI) SELF-LOCK
- Tr, Tr-F Rd
- Zubehör Accessories
- Tech. Info

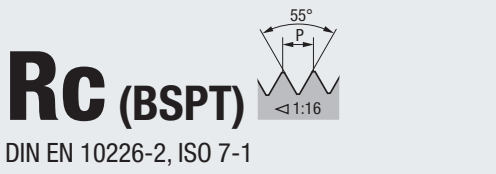

≈ DIN 374

Rc (BSPT)
DIN EN 10226-2, ISO 7-1

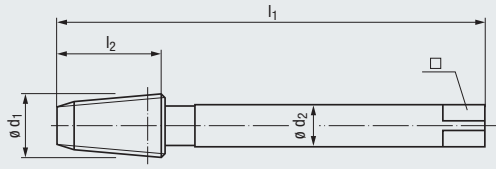

VA
Stainless steel materials



Technische Informationen
Technical information

» 245 - 266

Toleranz · Tolerance
Beschichtung · Coating
Schneidstoff · Cutting material



- HSSE
- C / 2-3
- E / O / P

Einsatzgebiete – Material
Applications – material

» 22

- P 1.1-4.1
- M 1.1-2.1
- K 2.1-4.2
- N 1.4-5, 2.4-6

Werkzeug-Ident · Tool ident

C0183000

Nenngröße Nom. size	P Gg/1" (tpi)	Dimens.-Ident				Rekord 2-KEG VA
		l ₁	l ₂	ø d ₂	□	
Rc 1/4	19	100	18	11	9	●
3/8	19	110	18	14	11	●
1/2	14	140	23	16	12	●
3/4	14	150	24	20	16	●
1"	11	170	30	25	20	●

≈ DIN 371 » 195

Gewindekernloch-Vorfertigungsdurchmesser für Rc-Gewinde siehe Seite 194
Thread hole preparatory diameters for Rc threads, see page 194



Kegelreibahlen 1:16 für kegelige Gewinde
Taper reamers 1:16 for tapered threads

» 200

Rc (BSPT)
DIN EN 10226-2, ISO 7-1



≈ DIN 2181

STEEL
Steel materials

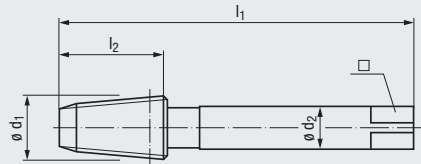

Technische Informationen
Technical information

» 245 - 266

Toleranz · Tolerance
Beschichtung · Coating
Schneidstoff · Cutting material



HSSE

C / 2-3

E / 0

Einsatzgebiete – Material
Applications – material

» 22

P 1.1-2.1

K 1.1-2

N 2.2-3

Werkzeug-Ident · Tool ident

A0181000

Nenngröße Nom. size	P						Dimens.- Ident	Rekord KEG STEEL
	ø d ₁	Gg/1" (tpi)	l ₁	l ₂	ø d ₂	□		
Rc 1/16	28	63	12	6	4,9	.4114	○	
1/8	28	63	12	7	5,5	.4115	●	
1/4	19	63	18	11	9	.4116	●	
3/8	19	70	18	12	9	.4117	●	
1/2	14	80	23	16	12	.4118	●	
3/4	14	100	24	20	16	.4119	●	
1"	11	110	30	25	20	.4120	●	

Gewindekernloch-Vorfertigungsdurchmesser für Rc-Gewinde siehe Seite 194
Thread hole preparatory diameters for Rc threads, see page 194



Kegelreibahlen 1:16 für kegelige Gewinde
Taper reamers 1:16 for tapered threads

» 200

- Product Finder
- Vc
- M
- MF
- UNC UN-8
- UNF UNEF
- G, Rp NPSM, NPSF
- NPT, NPTF Rc W
- BSW, BSF
- Pg
- MJ UNJC, UNJF
- EG (STI) SELF-LOCK
- Tr, Tr-F Rd
- Zubehör Accessories
- Tech. Info

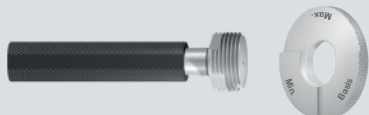

Gewindelehren für kegelige Gewinde
siehe Seite 611 - 613

Thread gauges for tapered threads,
see page 611 - 613

- Product Finder
- Vc
- M
- MF
- UNC UN-8
- UNF UNEF
- G, Rp NPSM, NPSF
- NPT, NPTF Rc, W
- BSW, BSF
- Pg
- MJ UNJC, UNJF
- EG (STI) SELF-LOCK
- Tr, Tr-F Rd
- Zubehör Accessories
- Tech. Info

W keg

DIN EN ISO 11363
DIN 477 kegelig · tapered

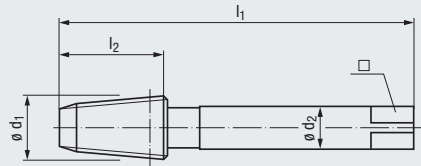

STEEL
Steel materials



Technische Informationen
Technical information

» 245 - 266

Toleranz · Tolerance
Beschichtung · Coating
Schneidstoff · Cutting material



HSSE

C / 2-3

E / 0

P 1.1-2.1

K 1.1-2

N 2.2-3

Einsatzgebiete – Material
Applications – material

» 22

Kegelig vorarbeiten
Tapered preparation of the thread hole

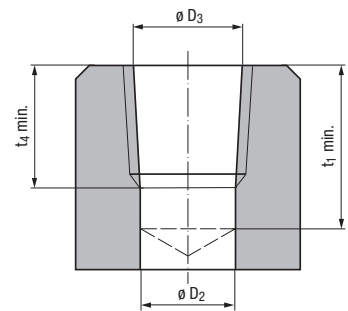

Werkzeug-Ident · Tool ident

A0181000

$\varnothing d_1$	P Gg/1" (tpi)	l_1	l_2	$\varnothing d_2$	\square	Dimens.- Ident	Rekord KEG STEEL	$\varnothing D_2$	$\varnothing D_3$ $\pm 0,06$	t_1 min.	t_4 min.
17E / W 19,8	14	95	30	16	12	.3286	○	14,6	16,82	24,5	22,5
25E / W 28,8	14	100	35	22	18	.3287	○	22,6	25,42	29,5	27,5

W zyl

DIN 477 zylindrisch · cylindrical

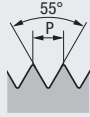

≈ DIN 5157

MS
Copper-zinc alloys

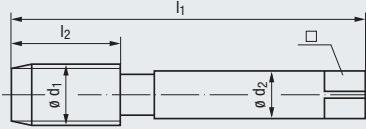

Technische Informationen
Technical information

» 245 - 266

Toleranz · Tolerance
Beschichtung · Coating
Schneidstoff · Cutting material



„X“

HSSE

C / 2-3

E

Gewindetiefe und Lochform
Thread depth and hole type

max. 2 x d₁

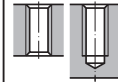

Einsatzgebiete – Material
Applications – material

» 22

N 2.3

Werkzeug-Ident · Tool ident

A0102501

W	Ø d ₁	P Gg/1" (tpi)	l ₁	l ₂	Ø d ₂	□	 Dimens.-Ident	Rekord A-MS					
									○				
	21,8	14	80	22	18	14,5	19,8	.3284	○				
	24,32	14	90	22	18	14,5	22,3	.3285	○				

- Product Finder
- V_c
- M
- MF
- UNC UN-8
- UNF UNEF
- G, Rp NPSM, NPSF
- NPT, NPTF Rc, W
- BSW, BSF
- Pg
- MJ UNJC, UNJF
- EG (ST) SELF-LOCK
- Tr, Tr-F Rd
- Zubehör Accessories
- Tech. Info



- Product Finder
- V_c
- M
- MF
- UNC UN-8
- UNF UNEF
- G, Rp NPSM, NPSF
- NPT, NPTF Rc
- BSW, BSF
- Pg
- MJ UNJC, UNJF
- EG (STI) SELF-LOCK
- Tr, Tr-F Rd
- Zubehör Accessories
- Tech. Info

Für konische Gewinde NPT, NPTF, Rc (BSPT), Kegel 1:16
 For tapered pipe threads NPT, NPTF, Rc (BSPT), taper 1:16

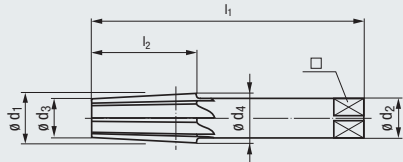

Technische Informationen Technical information		Schneidstoff · Cutting material								
		HSSE	HSSE L7							
Werkzeug-Ident · Tool ident		G0037165	G0037175							
Nenngröße Nom. size		KEG-RB 1:16 Form A	KEG-RB 1:16 Form B							
Ø d ₁	Ø d ₃ -0,05	Ø d ₄	l ₁	l ₂	Ø d ₂	□	Z	Dimens.- Ident		
1/16	5,95	7,0	70	17	6	4,9	6	.5763	●	●
1/8	8,05	9,1	70	17	7	5,5	6	.5764	●	●
1/4	10,30	12,0	80	27	11	9	6	.5765	●	●
3/8	13,75	15,4	85	27	12	9	8	.5766	●	●
1/2	16,95	19,1	95	35	16	12	8	.5767	●	●
3/4	22,25	24,5	105	35	20	16	10	.5768	●	●
1"	28,00	30,7	130	43	25	20	10	.5769	●	●
1 1/4	36,75	39,5	140	44	32	24	12	.5770	●	●
1 1/2	42,80	45,6	150	45	36	29	12	.5771	●	●
2"	54,80	57,7	160	46	45	35	14	.5772	●	●

Achtung! Die Reibahlen sind ggf. durch Kürzung von vorne der aktuellen Lochtiefe anzupassen.
 Please note: If needed, the reamers can be fitted to the required hole depth by shortening the cutting part.

BSW

BS 84



≈ DIN 371

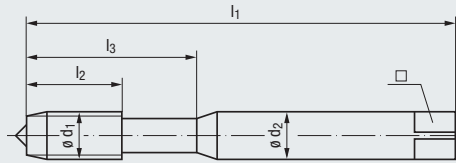

STEEL
Steel materials



VA
Stainless steel materials



Product Finder

Vc

M

MF

UNC UN-8

UNF UNEF

G, Rp NPSM, NPSF

NPT, NPTF Rc, W

BSW, BSF

Pg

MJ UNJC, UNJF

EG (ST) SELF-LOCK

Tr, Tr-F Rd

Zubehör Accessories

Tech. Info

Technische Informationen
Technical information

» 245 - 266

Toleranz · Tolerance
Beschichtung · Coating
Schneidstoff · Cutting material



med.

HSSE

R35

C / 2-3

E / O

med.

NT

HSSE

B / 4-5

E / O / P

med.

TIN

HSSE

B / 4-5

E / O / P

med.

GLT-1

HSSE

B / 4-5

E / O / P

Gewindetiefe und Lochform
Thread depth and hole type

max. 2,5 x d₁



max. 3 x d₁



Einsatzgebiete – Material
Applications – material

» 22

P 1.1-3.1
N 2.2

P 1.1-3.1
M 1.1-2.1
K 2.1
N 2.2, 2.5-6

P 1.1-4.1
M 1.1-3.1
K 2.1
N 2.2, 2.5-6

P 1.1-4.1
M 1.1-3.1
K 2.1
N 2.2

Werkzeug-Ident · Tool ident

B0501000

B0203000

B0203100

B020C300

	Ø d ₁		P Gg/1" (tpi)	l ₁	l ₂	l ₃	Ø d ₂	□	Image	Dimens.-Ident	Enorm 1-STEEL		Rekord 1B-VA NT	Rekord 1B-VA TIN	Rekord 1B-VA GLT-1
	inch	mm													
BSW	1/8	3,18	40	56	11	18	3,5	2,7	2,55	.3046	○		●	●	○
	5/32	3,97	32	63	13	21	4,5	3,4	3,2	.3047	○		●	○	○
	3/16	4,76	24	70	15	25	6	4,9	3,7	.3048	○		●	●	○
	7/32	5,56	24	80	16	30	6	4,9	4,5	.3049	○		●	○	○
	1/4	6,35	20	80	17	30	7	5,5	5,1	.3050	○		●	●	○
	5/16	7,94	18	90	20	35	8	6,2	6,5	.3051	○		●	●	○
	3/8	9,53	16	100	22	39	10	8	7,9	.3052	○		●	●	○

≈ DIN 376



» 203

» 203

» 203

» 203

- Product Finder
- V_c
- M
- MF
- UNC UN-8
- UNF UNEF
- G, Rp NPSM, NPSF
- NPT, NPTF Rc, W
- BSW, BSF
- Pg
- MJ UNJC, UNJF
- EG (STI) SELF-LOCK
- Tr, Tr-F Rd
- Zubehör Accessories
- Tech. Info

BSW

BS 84



≈ DIN 371

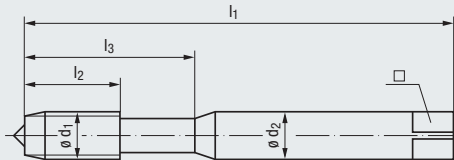

Toleranz · Tolerance
Beschichtung · Coating
Schneidstoff · Cutting material

Technische Informationen
Technical information

» 245 - 266

med.	med.
HSSE	GLT-1
R35	HSSE
C / 2-3	C / 2-3
E / O / P	E / O / P

Gewindetiefe und Lochform
Thread depth and hole type

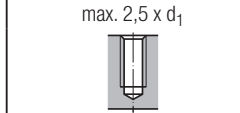

Einsatzgebiete – Material
Applications – material

» 22

P 1.1-3.1	P 1.1-4.1
M 1.1-2.1	M 1.1-3.1
K 2.1	K 2.1

Werkzeug-Ident · Tool ident

B0503000 B050C300

	ø d ₁ inch	ø d ₁ mm	P Gg/1" (tpi)	l ₁	l ₂	l ₃	ø d ₂	□	Dimens.- Ident	Enorm 1-VA		
										Enorm 1-VA	Enorm 1-VA GLT-1	
BSW	1/8	3,18	40	56	7	18	3,5	2,7	2,55	.3046	●	○
	5/32	3,97	32	63	7	21	4,5	3,4	3,2	.3047	○	○
	3/16	4,76	24	70	10	25	6	4,9	3,7	.3048	●	○
	7/32	5,56	24	80	10	30	6	4,9	4,5	.3049	○	○
	1/4	6,35	20	80	13	30	7	5,5	5,1	.3050	●	○
	5/16	7,94	18	90	14	35	8	6,2	6,5	.3051	●	○
	3/8	9,53	16	100	16	39	10	8	7,9	.3052	●	○

≈ DIN 376



204

204

BSW

BS 84



≈ DIN 376

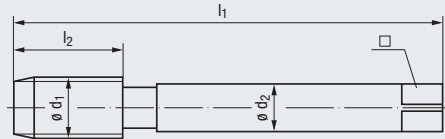

STEEL
Steel materials



VA
Stainless steel materials



- Product Finder
- Vc
- M
- MF
- UNC UN-8
- UNF UNF
- G, Rp NPSM, NPSF
- NPT, NPTF Rc, W
- BSW, BSF
- Pg
- MJ UNJC, UNJF
- EG (ST) SELF-LOCK
- Tr, Tr-F Rd
- Zubehör Accessories
- Tech. Info

Technische Informationen
Technical information

» 245 - 266

Toleranz · Tolerance
Beschichtung · Coating
Schneidstoff · Cutting material



med.	med.	med.	med.
HSSE	NT	TIN	GLT-1
R35	HSSE	HSSE	HSSE
C / 2-3	B / 4-5	B / 4-5	B / 4-5
E / 0	E / 0 / P	E / 0 / P	E / 0 / P

Gewindetiefe und Lochform
Thread depth and hole type

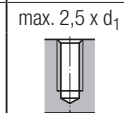

Einsatzgebiete – Material
Applications – material

» 22

P 1.1-3.1	P 1.1-3.1	P 1.1-4.1	P 1.1-4.1
N 2.2	M 1.1-2.1	M 1.1-3.1	M 1.1-3.1
	K 2.1	K 2.1	K 2.1
	N 2.2, 2.5-6	N 2.2, 2.5-6	N 2.2

Werkzeug-Ident · Tool ident

	Ø d ₁		P Gg/1" (tpi)	l ₁	l ₂	Ø d ₂		□	Dimens.-Ident	C0501000			
	inch	mm								Enorm 2-STEEL	Rekord 2B-VA NT	Rekord 2B-VA TIN	Rekord 2B-VA GLT-1
BSW	7/16	11,11	14	100	22	8	6,2	9,25	.3053	○	●	●	○
	1/2	12,70	12	110	25	9	7	10,5	.3054	○	●	●	○
	9/16	14,29	12	110	26	11	9	12	.3055	○	●	○	○
	5/8	15,88	11	110	27	12	9	13,5	.3056	○	●	●	○
	3/4	19,05	10	125	30	14	11	16,4	.3058	○	●	●	○
	7/8	22,23	9	140	32	18	14,5	19,25	.3060	○	●	○	○
	1"	25,40	8	160	36	18	14,5	22	.3062	○	●	●	○
	1 1/8	28,58	7	180	40	22	18	24,75	.3063	○			
	1 1/4	31,75	7	180	40	22	18	27,75	.3064	○			
	1 3/8	34,93	6	200	50	28	22	30,5	.3065	○			
	1 1/2	38,10	6	200	50	28	22	33,5	.3066	○			
	1 3/4	44,45	5	220	58	36	29	39	.3068	○			
	2"	50,80	4 1/2	250	65	40	32	44,5	.3070	○			

≈ DIN 371



201

201

201

201

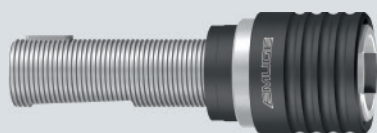

Schnellwechsel-Aufnahmen der Typenreihe SFM siehe Seite 733 - 738

Quick-change tap holders of our SFM series, see page 733 - 738

- Product Finder
- Vc
- M
- MF
- UNC UN-8
- UNF UNEF
- G, Rp NPSM, NPSF
- NPT, NPTF Rc, W
- BSW, BSF
- Pg
- MJ UNJC, UNJF
- EG (STI) SELF-LOCK
- Tr, Tr-F Rd
- Zubehör Accessories
- Tech. Info

BSW



BS 84

≈ DIN 376

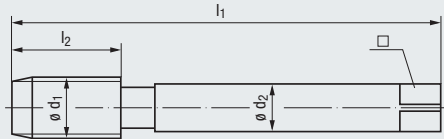

VA
Stainless steel materials



Toleranz · Tolerance
Beschichtung · Coating
Schneidstoff · Cutting material

Technische Informationen
Technical information

» 245 - 266

med.	med.
HSSE	GLT-1
R35	HSSE
C / 2-3	R35
E / O / P	C / 2-3
E / O / P	E / O / P

Gewindetiefe und Lochform
Thread depth and hole type

max. 2,5 x d₁



Einsatzgebiete – Material
Applications – material

» 22

P 1.1-3.1	P 1.1-4.1
M 1.1-2.1	M 1.1-3.1
K 2.1	K 2.1

Werkzeug-Ident · Tool ident

C0503000 C050C300

	ø d ₁ inch	ø d ₁ mm	P Gg/1" (tpi)	l ₁	l ₂	ø d ₂	□		Dimens.- Ident	Enorm 2-VA	Enorm 2-VA GLT-1
	1/2	12,70	12	110	20	9	7	10,5	.3054	○	○
	9/16	14,29	12	110	20	11	9	12	.3055		
	5/8	15,88	11	110	22	12	9	13,5	.3056	○	○
	3/4	19,05	10	125	25	14	11	16,4	.3058	○	○
	7/8	22,23	9	140	27	18	14,5	19,25	.3060	○	○
	1"	25,40	8	160	30	18	14,5	22	.3062	○	○
	1 1/8	28,58	7	180	35	22	18	24,75	.3063		
	1 1/4	31,75	7	180	35	22	18	27,75	.3064		
	1 3/8	34,93	6	200	40	28	22	30,5	.3065		
	1 1/2	38,10	6	200	40	28	22	33,5	.3066		
	1 3/4	44,45	5	220	45	36	29	39	.3068		
	2"	50,80	4 1/2	250	50	40	32	44,5	.3070		

≈ DIN 371



202

202

BSW

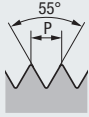

≈ DIN 352

BS 84

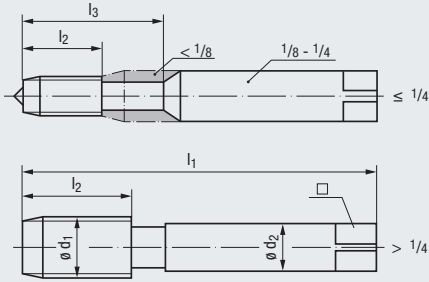

- Product Finder
- Vc
- M
- MF
- UNC UN-8
- UNF UNEF
- G, Rp NPSM, NPSF
- NPT, NPTF Rc, W
- BSW, BSF
- Pg
- MJ UNJC, UNJF
- EG (ST) SELF-LOCK
- Tr, Tr-F Rd
- Zubehör Accessories
- Tech. Info

Technische Informationen Technical information	▶ 245 - 266	Toleranz · Tolerance Beschichtung · Coating Schneidstoff · Cutting material	med. „X“	med. „X“		
			HSSE	HSSE	HSSE	HSSE
			A / 5-6 O / P	D / 3-4 O / P	C / 2-3 O / P	C / 2-3 O / P

Gewindetiefe und Lochform Thread depth and hole type	max. 2 x d ₁ 			
---	-----------------------------	--	--	--

Einsatzgebiete – Material Applications – material	▶ 22			
--	------	--	--	--

Werkzeug-Ident · Tool ident												H0111019	H0111029	H0111001	H0101001
BSW	ø d ₁ inch	ø d ₁ mm	P Gg/1" (tpi)	l ₁	l ₂	l ₃	ø d ₂	□		Dimens.- Ident	HGB-Set V-Nr.1	HGB-Set M-Nr.2	HGB-Set F	HGB-Set 3S (Nr.1, Nr.2, F)	
	1/16	1,59	60	32	8	—	2,5	2,1	1,15	.3044	○	○	○	○	
	3/32	2,38	48	40	9	—	2,8	2,1	1,85	.3045	○	○	○	○	
	1/8	3,18	40	40	10	18	3,5	2,7	2,55	.3046	○	○	○	○	
	5/32	3,97	32	45	12	22	4,5	3,4	3,2	.3047	○	○	○	○	
	3/16	4,76	24	50	14	25	6	4,9	3,7	.3048	○	○	○	○	
	7/32	5,56	24	56	16	28	6	4,9	4,5	.3049	○	○	○	○	
	1/4	6,35	20	56	16	28	6	4,9	5,1	.3050	○	○	○	○	
	5/16	7,94	18	63	20	—	6	4,9	6,5	.3051	○	○	○	○	
	3/8	9,53	16	70	22	—	7	5,5	7,9	.3052	○	○	○	○	
	7/16	11,11	14	70	22	—	8	6,2	9,25	.3053	○	○	○	○	
	1/2	12,70	12	75	25	—	9	7	10,5	.3054	○	○	○	○	
	9/16	14,29	12	80	26	—	11	9	12	.3055	○	○	○	○	
	5/8	15,88	11	80	27	—	12	9	13,5	.3056	○	○	○	○	
	3/4	19,05	10	95	32	—	14	11	16,4	.3058	○	○	○	○	
	7/8	22,23	9	100	32	—	18	14,5	19,25	.3060	○	○	○	○	
	1"	25,40	8	110	36	—	18	14,5	22	.3062	○	○	○	○	
	1 1/8	28,58	7	125	40	—	22	18	24,75	.3063	○	○	○	○	
	1 1/4	31,75	7	125	40	—	22	18	27,75	.3064	○	○	○	○	
	1 3/8	34,93	6	150	50	—	28	22	30,5	.3065	○	○	○	○	
	1 1/2	38,10	6	150	50	—	28	22	33,5	.3066	○	○	○	○	
	1 5/8	41,28	5	150	56	—	32	24	35,5	.3067	○	○	○	○	
	1 3/4	44,45	5	160	58	—	36	29	39	.3068	○	○	○	○	
	1 7/8	47,63	4 1/2	180	65	—	36	29	41,5	.3069	○	○	○	○	
	2"	50,80	4 1/2	180	65	—	40	32	44,5	.3070	○	○	○	○	

- Product Finder
- Vc
- M
- MF
- UNC UN-8
- UNF UNEF
- G, Rp NPSM, NPSF
- NPT, NPTF Rc, W
- BSW, BSF
- Pg
- MJ UNJC, UNJF
- EG (STI) SELF-LOCK
- Tr, Tr-F Rd
- Zubehör Accessories
- Tech. Info



BS 84

≈ DIN 371

STEEL
Steel materials

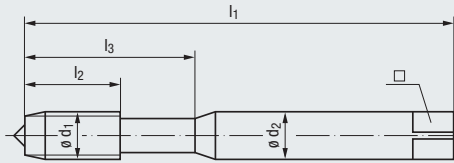

Technische Informationen
Technical information

» 245 - 266

Toleranz · Tolerance
Beschichtung · Coating
Schneidstoff · Cutting material



med. „X“

HSSE

C / 2-3

E / 0

Gewindetiefe und Lochform
Thread depth and hole type

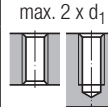

P 1.1-3.1
N 2.3

Einsatzgebiete – Material
Applications – material

» 22

Werkzeug-Ident · Tool ident

B0101001

	ø d ₁ inch	ø d ₁ mm	P Gg/1" (tpi)	l ₁	l ₂	l ₃	ø d ₂	□	Dimens.- Ident	Rekord 1A-STEEL				
BSF	1/4	6,35	26	80	17	30	7	5,5	5,3	.3090	●			
	5/16	7,94	22	90	17	35	8	6,2	6,8	.3092	●			
	3/8	9,53	20	100	18	39	10	8	8,3	.3093	●			

≈ DIN 374



» 207

BSF



BS 84

≈ DIN 374

STEEL
Steel materials

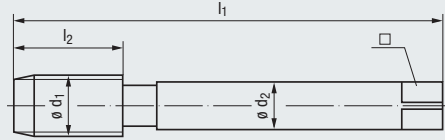

Technische Informationen
Technical information

» 245 - 266

Toleranz · Tolerance
Beschichtung · Coating
Schneidstoff · Cutting material



med. „X“

HSSE

C / 2-3

E / 0

Gewindetiefe und Lochform
Thread depth and hole type

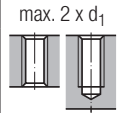

Einsatzgebiete – Material
Applications – material

» 22

P 1.1-3.1
N 2.3

Werkzeug-Ident · Tool ident

C0101001

Rekord 2A-STEEL

	∅ d ₁ inch	∅ d ₁ mm	P Gg/1" (tpi)	l ₁	l ₂	∅ d ₂	□		Dimens.- Ident				
BSF	7/16	11,11	18	100	22	8	6,2	9,7	.3094	○			
	1/2	12,70	16	100	22	9	7	11,1	.3095	○			
	5/8	15,88	14	110	27	12	9	14	.3097	○			
	3/4	19,05	12	125	27	14	11	16,75	.3099	○			
	7/8	22,23	11	140	32	18	14,5	19,75	.3101	○			
	1"	25,40	10	160	36	18	14,5	22,75	.3102	○			

≈ DIN 371



» 206

Product Finder

V_c

M

MF

UNC UN-8

UNF UNEF

G, Rp NPSM, NPSF

NPT, NPTF Rc, W

BSW, BSF

Pg

MJ UNJC, UNJF

EG (ST) SELF-LOCK

Tr, Tr-F Rd

Zubehör Accessories

Tech. Info



- Product Finder
- V_c
- M
- MF
- UNC UN-8
- UNF UNEF
- G, Rp NPSM, NPSF
- NPT, NPTF Rc, W
- BSW, BSF
- Pg
- MJ UNJC, UNJF
- EG (STI) SELF-LOCK
- Tr, Tr-F Rd
- Zubehör Accessories
- Tech. Info

BSF

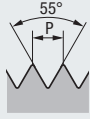

≈ DIN 352

BS 84

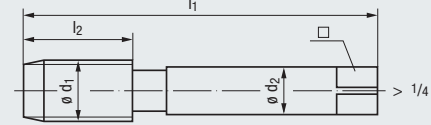
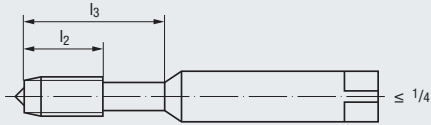

Technische Informationen Technical information	Toleranz · Tolerance Beschichtung · Coating Schneidstoff · Cutting material	med. „X“	med. „X“		
		HSSE	HSSE	HSSE	HSSE
245 - 266		A / 5-6 O / P	D / 3-4 O / P	C / 2-3 O / P	C / 2-3 O / P

Gewindetiefe und Lochform Thread depth and hole type	max. 2 x d ₁ 			
---	-----------------------------	--	--	--

Einsatzgebiete – Material Applications – material	P 1.1-3.1	P 1.1-3.1	P 1.1-3.1	P 1.1-3.1
--	-----------	-----------	-----------	-----------

Werkzeug-Ident · Tool ident											H0111019	H0111029	H0111001	H0101001
										Dimens.-Ident	HGB-Set V-Nr.1	HGB-Set M-Nr.2	HGB-Set F	HGB-Set 3S (Nr.1, Nr.2, F)
Ø d ₁ inch	Ø d ₁ mm	P Gg/1" (tpi)	l ₁	l ₂	l ₃	Ø d ₂	□							
BSF	3/16	4,76	32	50	14	25	6	4,9	4	.3088	○	○	○	○
	1/4	6,35	26	56	16	28	6	4,9	5,3	.3090	○	○	○	○
	5/16	7,94	22	63	17	–	6	4,9	6,8	.3092	○	○	○	○
	3/8	9,53	20	70	22	–	7	5,5	8,3	.3093	○	○	○	○
	7/16	11,11	18	70	22	–	8	6,2	9,7	.3094	○	○	○	○
	1/2	12,70	16	70	20	–	9	7	11,1	.3095	○	○	○	○
	5/8	15,88	14	80	27	–	12	9	14	.3097	○	○	○	○
	3/4	19,05	12	80	22	–	14	11	16,75	.3099	○	○	○	○
	7/8	22,23	11	80	22	–	18	14,5	19,75	.3101	○	○	○	○
	1"	25,40	10	110	36	–	18	14,5	22,75	.3102	○	○	○	○

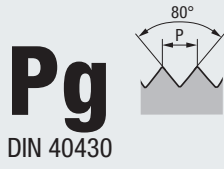

Pg
DIN 40430

DIN 40433

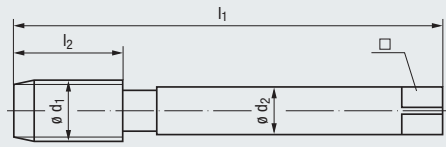

- Product Finder
- Vc
- M
- MF
- UNC UN-8
- UNF UNEF
- G, Rp NPSM, NPSF
- NPT, NPTF Rc, W
- BSW, BSF
- Pg**
- MJ UNJC, UNJF
- EG (STI) SELF-LOCK
- Tr, Tr-F Rd
- Zubehör Accessories
- Tech. Info

Technische Informationen Technical information	Toleranz · Tolerance Beschichtung · Coating Schneidstoff · Cutting material	„X“	„X“
		HSSE	NT HSSE
Technische Informationen Technical information	Schneidstoff · Cutting material	C / 2-3	C / 2-3
		E / 0	E / 0 / P

Gewindetiefe und Lochform Thread depth and hole type	max. 2 x d ₁	max. 2 x d ₁

Einsatzgebiete – Material Applications – material	P 1.1-3.1 N 2.3	P 1.1-3.1 K 1.1-4.2 N 2.4-7 N 4.1, 5.1
--	--------------------	---

Werkzeug-Ident · Tool ident

Nenngröße Nom. size									Dimens.-Ident	Rekord 2A-STEEL	Rekord 2A-H NT
Ø d ₁	Ø d ₁ mm	P Gg/1" (tpi)	l ₁	l ₂	Ø d ₂	□					
Pg 7	12,5	20	100	22	9	7	11,35	.4153	●	●	
9	15,2	18	100	22	12	9	13,95	.4154	●	●	
11	18,6	18	110	25	14	11	17,35	.4155	●	●	
13,5	20,4	18	125	25	16	12	19,15	.4156	●	●	
16	22,5	18	125	25	18	14,5	21,25	.4157	●	●	
21	28,3	16	150	28	22	18	26,95	.4158	○	○	
29	37,0	16	170	30	28	22	35,6	.4159	○	○	
36	47,0	16	190	32	36	29	45,6	.4160	○		
42	54,0	16	190	32	40	32	52,6	.4161	○		
48	59,3	16	220	36	45	35	57,9	.4162	○		

● = Lagerwerkzeug, siehe Preisliste · Stock tool, see price list
 ○ = Kurzfristig lieferbar, Preis auf Anfrage · Available on short notice, price upon inquiry

- Product Finder
- V_c
- M
- MF
- UNC UN-8
- UNF UNEF
- G, Rp NPSM, NPSF
- NPT, NPTF Rc, W
- BSW, BSF
- Pg
- MJ UNJC, UNJF
- EG (STI) SELF-LOCK
- Tr, Tr-F Rd
- Zubehör Accessories
- Tech. Info



DIN ISO 5855

DIN 371

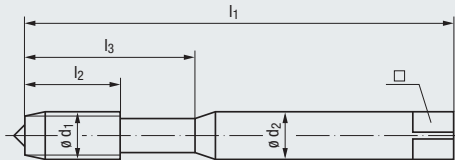

AL
Aluminium wrought alloys



TI
Titanium



Technische Informationen
Technical information

» 245 - 266

Toleranz · Tolerance
Beschichtung · Coating
Schneidstoff · Cutting material



- 4H
- GLT-8
- HSSE
- R45
- C / 2-3
- E / O

- 4HX
- TICN
- HSSE
- L15
- D / 4-5
- E / O / P

- 4HX
- TICN
- HSSE
- R15
- C / 2-3
- E / O / P

Gewindetiefe und Lochform
Thread depth and hole type

max. 2,5 x d₁



max. 3 x d₁



max. 2 x d₁



Einsatzgebiete – Material
Applications – material

» 22

N 1.1-4

- P 4.1-5.1**
- M 3.1-4.1**
- N 2.4-5, 2.7**
- S 1.1-2.2, 2.4**

- P 4.1-5.1**
- M 3.1-4.1**
- N 2.4-5, 2.7**
- S 1.1-2.2, 2.4**

Werkzeug-Ident · Tool ident

B050S810

B0309611

B0459611

	∅ d ₁ mm	P mm	l ₁	l ₂	l ₃	∅ d ₂	□	Image	Dimens.- Ident	Enorm 1-AL GLT-8			Rekord 1C-TI TICN		Rekord 1D-TI TICN	
										●	●	●	●	●	●	
MJ	3	x 0,5	56	11	18	3,5	2,7	2,6	.1229	●	●	●	●	●	●	
	4	x 0,7	63	13	21	4,5	3,4	3,4	.1231	●	●	●	●	●	●	
	5	x 0,8	70	15	25	6	4,9	4,3	.1232	●	●	●	●	●	●	
	6	x 1	80	17	30	6	4,9	5,1	.1233	●	●	●	●	●	●	
	8	x 1	90	17	35	8	6,2	7,1	.1235	●	●	●	●	●	●	
	8	x 1,25	90	20	35	8	6,2	6,9	.2026	●	●	●	●	●	●	
	10	x 1,25	100	18	39	10	8	8,9	.1236	●	●	●	●	●	●	
	10	x 1,5	100	22	39	10	8	8,6	.2308	●	●	●	●	●	●	

MJ

DIN ISO 5855



DIN 371

NI
Nickel alloys

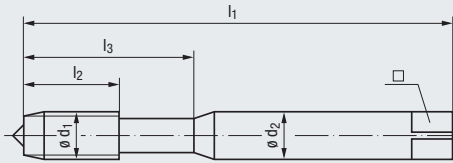

Technische Informationen
Technical information

» 245 - 266

Toleranz · Tolerance
Beschichtung · Coating
Schneidstoff · Cutting material



4HX	4HX
TICN	TICN
HSSE-PM	HSSE-PM
L08	R10
D / 4-5	C / 2-3
O / P	O / P

Gewindetiefe und Lochform
Thread depth and hole type

max. 3 x d ₁	max. 2 x d ₁

Einsatzgebiete – Material
Applications – material

» 22

M 4.1	M 4.1
N 2.8	N 2.8
S 1.2-3	S 1.2-3
S 2.3, 2.5-6	S 2.3, 2.5-6

Werkzeug-Ident · Tool ident

B030J411 **B438J411**

MJ	ø d ₁ mm	P mm	l ₁	l ₂	l ₃	ø d ₂	□		Dimens.- Ident	Rekord	Rekord			
										1C-NI-PM TICN	1DF-NI-PM TICN			
	3	x 0,5	56	11	18	3,5	2,7	2,6	.1229	●	●			
	4	x 0,7	63	13	21	4,5	3,4	3,4	.1231	●	●			
	5	x 0,8	70	15	25	6	4,9	4,3	.1232	●	●			
	6	x 1	80	17	30	6	4,9	5,1	.1233	●	●			
	8	x 1	90	17	35	8	6,2	7,1	.1235	●	●			
	8	x 1,25	90	20	35	8	6,2	6,9	.2026	●	●			
	10	x 1,25	100	18	39	10	8	8,9	.1236	●	●			
	10	x 1,5	100	22	39	10	8	8,6	.2308	●	●			

- Product Finder
- V_c
- M
- MF
- UNC UN-8
- UNF UNEF
- G, Rp NPSM, NPSF
- NPT, NPTF Rc, W
- BSW, BSF
- Pg
- MJ** UNJC, UNJF
- EG (ST) SELF-LOCK
- Tr, Tr-F Rd
- Zubehör Accessories
- Tech. Info

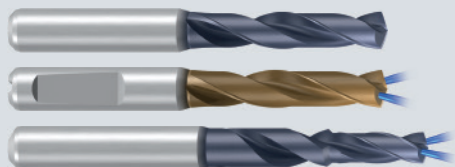

Spiralbohrer siehe Seite 507 - 580

Twist drills, see page 507 - 580

- Product Finder
- V_c
- M
- MF
- UNC UN-8
- UNF UNEF
- G, Rp NPSM, NPSF
- NPT, NPTF Rc, W
- BSW, BSF
- Pg
- MJ UNJC UNJF
- EG (STI) SELF-LOCK
- Tr, Tr-F Rd
- Zubehör Accessories
- Tech. Info

UNJC

ASME B1.15

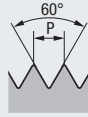

≈ DIN 371

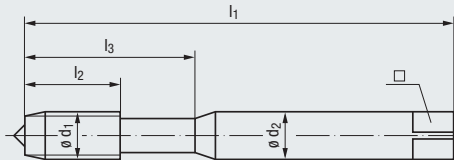

AL
Aluminium wrought alloys



TI
Titanium



Technische Informationen
Technical information

» 245 - 266

Toleranz · Tolerance
Beschichtung · Coating
Schneidstoff · Cutting material



- 3B
- GLT-8
- HSSE
- R45
- C / 2-3
- E / O

- 3BX
- TICN
- HSSE
- L15
- D / 4-5
- E / O / P

- 3BX
- TICN
- HSSE
- R15
- C / 2-3
- E / O / P

Gewindetiefe und Lochform
Thread depth and hole type

max. 2,5 x d₁



max. 3 x d₁



max. 2 x d₁



Einsatzgebiete – Material
Applications – material

» 22

N 1.1-4

P 4.1-5.1
M 3.1-4.1
N 2.4-5, 2.7
S 1.1-2.2, 2.4

P 4.1-5.1
M 3.1-4.1
N 2.4-5, 2.7
S 1.1-2.2, 2.4

Werkzeug-Ident · Tool ident

B050S810

B0309611

B0459611

Nr.	Ø d ₁ inch	P Gg/1" (tpi)	l ₁	l ₂	l ₃	Ø d ₂	□	Image	Dimens.-Ident	Enorm 1, Rekord 1		
										Enorm 1-AL GLT-8	Rekord 1C-TI TICN	Rekord 1D-TI TICN
Nr. 4	0.1120	40	56	11	18	3,5	2,7	2,3	.5479	●	●	●
Nr. 6	0.1380	32	56	12	20	4	3	2,85	.5481	●	●	●
Nr. 8	0.1640	32	63	13	21	4,5	3,4	3,5	.5482	●	●	●
Nr. 10	0.1900	24	70	15	25	6	4,9	3,9	.5483	●	●	●
1/4	0.2500	20	80	17	30	7	5,5	5,25	.5485	●	●	●
5/16	0.3125	18	90	20	35	8	6,2	6,7	.5486	●	●	●
3/8	0.3750	16	100	22	39	10	8	8,1	.5487	●	●	●

UNJC

ASME B1.15

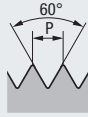

≈ DIN 371

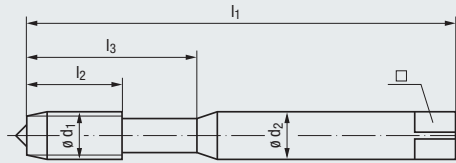

NI
Nickel
alloys



Technische Informationen
Technical information

» 245 - 266

Toleranz · Tolerance
Beschichtung · Coating
Schneidstoff · Cutting material



3BX	3BX
TICN	TICN
HSSE-PM	HSSE-PM
L08	R10
D / 4-5	C / 2-3
O / P	O / P

Gewindetiefe und Lochform
Thread depth and hole type

max. 3 x d ₁	max. 2 x d ₁

Einsatzgebiete – Material
Applications – material

» 22

M 4.1	M 4.1
N 2.8	N 2.8
S 1.2-3	S 1.2-3
S 2.3, 2.5-6	S 2.3, 2.5-6

Werkzeug-Ident · Tool ident

B030J411 B438J411

Nr.	ø d ₁		P Gg/1" (tpi)	l ₁	l ₂	l ₃	ø d ₂	□		Dimens.- Ident	Rekord	
	inch	inch									1C-NI-PM TICN	1DF-NI-PM TICN
Nr. 4	0.1120		40	56	11	18	3,5	2,7	2,3	.5479	○	○
Nr. 6	0.1380		32	56	12	20	4	3	2,85	.5481	○	○
Nr. 8	0.1640		32	63	13	21	4,5	3,4	3,5	.5482	○	○
Nr. 10	0.1900		24	70	15	25	6	4,9	3,9	.5483	○	○
1/4	0.2500		20	80	17	30	7	5,5	5,25	.5485	○	○
5/16	0.3125		18	90	20	35	8	6,2	6,7	.5486	○	○
3/8	0.3750		16	100	22	39	10	8	8,1	.5487	○	○

- Product Finder
- V_c
- M
- MF
- UNC UN-8
- UNF UNEF
- G, Rp NPSM, NPSF
- NPT, NPTF Rc, W
- BSW, BSF
- Pg
- MJ UNJC, UNJF
- EG (ST) SELF-LOCK
- Tr, Tr-F Rd
- Zubehör Accessories
- Tech. Info



- Product Finder
- V_c
- M
- MF
- UNC UN-8
- UNF UNEF
- G, Rp NPSM, NPSF
- NPT, NPTF Rc, W
- BSW, BSF
- Pg
- MJ UNJC, UNJF
- EG (STI) SELF-LOCK
- Tr, Tr-F Rd
- Zubehör Accessories
- Tech. Info

UNJF

ASME B1.15

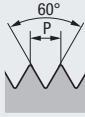

≈ DIN 371

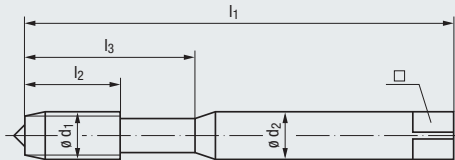

AL
Aluminium wrought alloys



TI
Titanium



Technische Informationen Technical information	Toleranz · Tolerance Beschichtung · Coating Schneidstoff · Cutting material	3B	3BX	3BX
		GLT-8	TICN	TICN
Technische Informationen Technical information	Schneidstoff · Cutting material	HSSE	HSSE	HSSE
		R45	L15	R15
		C / 2-3	D / 4-5	C / 2-3
		E / 0	E / 0 / P	E / 0 / P

Gewindetiefe und Lochform Thread depth and hole type	max. 2,5 x d ₁	max. 3 x d ₁	max. 2 x d ₁

Einsatzgebiete – Material Applications – material	N 1.1-4	P 4.1-5.1	P 4.1-5.1
		M 3.1-4.1	M 3.1-4.1
		N 2.4-5, 2.7	N 2.4-5, 2.7
		S 1.1-2.2, 2.4	S 1.1-2.2, 2.4

Werkzeug-Ident · Tool ident	B050S810	B0309611	B0459611
-----------------------------	----------	----------	----------

Nr.	ø d ₁ inch	P Gg/1" (tpi)	l ₁	l ₂	l ₃	ø d ₂	□		Dimens.-Ident	Enorm 1-AL GLT-8			Rekord 1C-TI TICN		Rekord 1D-TI TICN	
										●	●	●	●	●	●	
Nr. 4	0.1120	48	56	11	18	3,5	2,7	2,4	.5505	●	●	●	●	●	●	
Nr. 6	0.1380	40	56	12	20	4	3	3	.5507	●	●	●	●	●	●	
Nr. 8	0.1640	36	63	13	21	4,5	3,4	3,55	.5508	●	●	●	●	●	●	
Nr. 10	0.1900	32	70	15	25	6	4,9	4,15	.5509	●	●	●	●	●	●	
1/4	0.2500	28	80	17	30	7	5,5	5,55	.5511	●	●	●	●	●	●	
5/16	0.3125	24	90	17	35	8	6,2	7	.5512	●	●	●	●	●	●	
3/8	0.3750	24	90	18	35	10	8	8,6	.5513	●	●	●	●	●	●	

UNJF

ASME B1.15

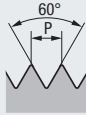

≈ DIN 371

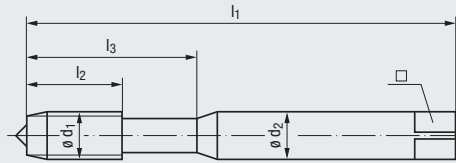

NI
Nickel
alloys



Product Finder

Vc

M

MF

UNC
UN-8

UNF
UNEF

G, Rp
NPSM, NPSF

NPT, NPTF
Rc, W

BSW, BSF

Pg

MJ

UNJC **UNJF**

EG (STI)
SELF-LOCK

Tr, Tr-F
Rd

Zubehör
Accessories

Tech. Info

Technische Informationen
Technical information

» 245 - 266

Toleranz · Tolerance
Beschichtung · Coating
Schneidstoff · Cutting material



3BX	3BX
TICN	TICN
HSSE-PM	HSSE-PM
L08	R10
D / 4-5	C / 2-3
O / P	O / P

Gewindetiefe und Lochform
Thread depth and hole type

max. 3 x d ₁	max. 2 x d ₁

Einsatzgebiete – Material
Applications – material

» 22

M 4.1	M 4.1
N 2.8	N 2.8
S 1.2-3	S 1.2-3
S 2.3, 2.5-6	S 2.3, 2.5-6

Werkzeug-Ident · Tool ident

B030J411 B438J411

Nr.	Ø d ₁		P Gg/1" (tpi)	l ₁	l ₂	l ₃	Ø d ₂	□	Dimens.- Ident	Rekord 1C-NI-PM TICN	Rekord 1DF-NI-PM TICN	
	inch	inch										
Nr. 4	0.1120		48	56	11	18	3,5	2,7	2,4	.5505	○	○
Nr. 6	0.1380		40	56	12	20	4	3	3	.5507	○	○
Nr. 8	0.1640		36	63	13	21	4,5	3,4	3,55	.5508	○	○
Nr. 10	0.1900		32	70	15	25	6	4,9	4,15	.5509	○	○
1/4	0.2500		28	80	17	30	7	5,5	5,55	.5511	○	○
5/16	0.3125		24	90	17	35	8	6,2	7	.5512	○	○
3/8	0.3750		24	90	18	35	10	8	8,6	.5513	○	○

- Product Finder
- V_c
- M
- MF
- UNC UN-8
- UNF UNEF
- G, Rp NPSM, NPSF
- NPT, NPTF Rc, W
- BSW, BSF
- Pg
- MJ UNJC, UNJF
- EG (STI)** SELF-LOCK
- Tr, Tr-F Rd
- Zubehör Accessories
- Tech. Info

EG M (STI)

DIN 8140-2

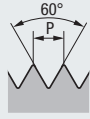

DIN 40435

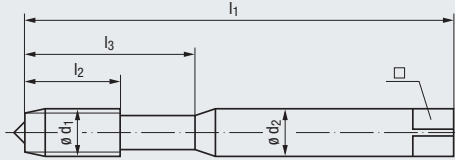

VA
Stainless steel materials



new

Toleranz · Tolerance
Beschichtung · Coating
Schneidstoff · Cutting material

Technische Informationen
Technical information

» 245 - 266



6H mod.	6H mod.	6H mod.
NT	TIN	GLT-1
HSSE	HSSE	HSSE
B / 4-5	B / 4-5	B / 4-5
E / O / P	E / O / P	E / O / P

Gewindetiefe und Lochform
Thread depth and hole type

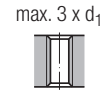

Einsatzgebiete – Material
Applications – material

» 22

P 1.1-3.1	P 1.1-4.1	P 1.1-4.1
M 1.1-2.1	M 1.1-3.1	M 1.1-3.1
K 2.1	K 2.1	K 2.1
N 2.2, 2.5-6	N 2.2, 2.5-6	N 2.2

Werkzeug-Ident · Tool ident

B0203000 B0203100 B020C300

Nenngröße Nom. size									Dimens.- Ident	Rekord 1B-VA NT	Rekord 1B-VA TIN	Rekord 1B-VA GLT-1
	Ø d ₁	Ø d ₁ mm	P mm	l ₁	l ₂	l ₃	Ø d ₂	□				
EG M 2,5	3,085	0,45	56	11	18	3,5	2,7	2,65	.0965	●	●	○
3	3,650	0,5	63	10	21	4,5	3,4	3,15	.0966	●	●	○
4	4,910	0,7	70	12	25	6	4,9	4,2	.0968	●	●	○
5	6,040	0,8	80	13	30	6	4,9	5,25	.0970	●	●	○
6	7,300	1	90	17	35	8	6,2	6,3	.0971	●	●	○
8	9,624	1,25	100	18	39	10	8	8,4	.0973	●	●	○









DIN 40435



» 218

» 218

» 218

AL Aluminium wrought alloys			Z CNC-controlled machines						
									
6H mod.	6H mod.	6H mod.	6H mod.	6H mod.	6H mod.				
HSSE	GLT-8 HSSE	GLT-8 HSSE	HSSE	HSSE	TIN HSSE				
B / ≈3	B / ≈3	C / 2-3	R45	R45	R45				
E / 0	E / 0	E / 0	C / 2-3	E / 1,5-2	E / 1,5-2				
E / 0 / P	E / 0 / P	E / 0 / P	E / 0 / P	E / 0 / P	E / 0 / P				
max. 3 x d ₁ 		max. 2,5 x d ₁ 	max. 3 x d ₁ 						
N 1.1-4	N 1.1-4	N 1.1-4	P 1.1-4.1	P 1.1-4.1	P 1.1-4.1				
			M 1.1-2.1	M 1.1-2.1	M 1.1-3.1				
			N 2.1	N 2.1	N 1.4-6				
					N 2.1-2, 2.4-5				
					S 1.1				
B0204500	B020S800	B050S800	B0503500	B0513500	B0513700				
Rekord 1B-AL	Rekord 1B-AL GLT-8	Enorm 1-AL GLT-8	Enorm 1-Z	Enorm 1-Z/E	Enorm 1-Z/E TIN				
●	●	●	●	●	●				EG M 2,5
●	●	●	●	●	●				3
●	●	●	●	●	●				4
●	●	●	●	●	●				5
●	●	●	●	●	●				6
●	●	●	●	●	●				8
		📄 219	📄 219	📄 219	📄 219				

- Product Finder
- V_c
- M
- MF
- UNC UN-8
- UNF UNEF
- G, Rp NPSM, NPSF
- NPT, NPTF Rc, W
- BSW, BSF
- Pg
- MJ UNJC, UNJF
- EG (STI) SELF-LOCK**
- Tr, Tr-F Rd
- Zubehör Accessories
- Tech. Info



- Product Finder
- Vc
- M
- MF
- UNC UN-8
- UNF UNEF
- G, Rp NPSM, NPSF
- NPT, NPTF Rc, W
- BSW, BSF
- Pg
- MJ UNJC, UNJF
- EG (STI) SELF-LOCK**
- Tr, Tr-F Rd
- Zubehör Accessories
- Tech. Info

EG M (STI)

DIN 8140-2



DIN 40435

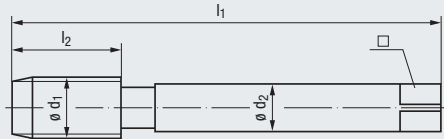

VA
Stainless steel materials



new

Technische Informationen
Technical information

Toleranz · Tolerance
 Beschichtung · Coating
 Schneidstoff · Cutting material

» 245 - 266

6H mod.	6H mod.	6H mod.
NT	TIN	GLT-1
HSSE	HSSE	HSSE
B / 4-5	B / 4-5	B / 4-5
E / O / P	E / O / P	E / O / P

Gewindetiefe und Lochform
Thread depth and hole type

max. 3 x d₁



Einsatzgebiete – Material
Applications – material

» 22

P 1.1-3.1	P 1.1-4.1	P 1.1-4.1
M 1.1-2.1	M 1.1-3.1	M 1.1-3.1
K 2.1	K 2.1	K 2.1
N 2.2, 2.5-6	N 2.2, 2.5-6	N 2.2

Werkzeug-Ident · Tool ident

C0203000 C0203100 C020C300

Nenngröße Nom. size								Dimens.- Ident	Rekord 2B-VA NT	Rekord 2B-VA TIN	Rekord 2B-VA GLT-1
	Ø d ₁	Ø d ₁ mm	P mm	l ₁	l ₂	Ø d ₂	□				
EG M 10	10	11,948	1,5	100	22	9	7	10,5	●	●	○
12	12	14,274	1,75	110	26	11	9	12,5	●	●	○
14	14	16,598	2	110	27	12	9	14,5	●	●	○
16	16	18,598	2	125	27	14	11	16,5	●	●	○
18	18	21,248	2,5	140	32	18	14,5	18,75	●	●	○
20	20	23,248	2,5	160	34	18	14,5	20,75	●	●	○

DIN 40435



» 216

» 216

» 216

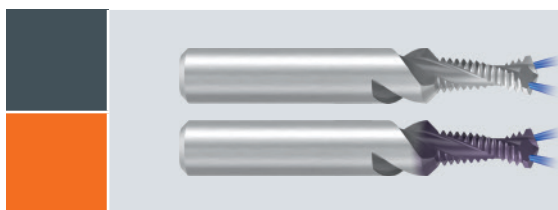

Bohrgewindefräser für
Metrisches EG-Gewinde
siehe Seite 350 - 351

Drill thread mills for
Metric STI thread,
see page 350 - 351

EG M (STI)

DIN 8140-2



DIN 40435

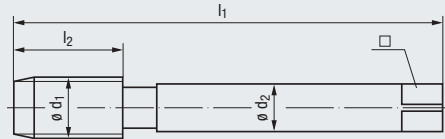

AL
Aluminium wrought alloys



Z
CNC-controlled machines



Product Finder

Vc

M

MF

UNC UN-8

UNF UNEF

G, Rp NPSM, NPSF

NPT, NPTF Rc, W

BSW, BSF

Pg

MJ UNJC, UNJF

EG (STI) SELF-LOCK

Tr, Tr-F Rd

Zubehör Accessories

Tech. Info

Technische Informationen
Technical information

» 245 - 266

Toleranz · Tolerance
Beschichtung · Coating
Schneidstoff · Cutting material



6H mod.

GLT-8

HSSE

R35

C / 2-3

E / 0

6H mod.

HSSE

R45

C / 2-3

E / 0 / P

6H mod.

HSSE

R45

E / 1,5-2

E / 0 / P

6H mod.

TIN

HSSE

R45

E / 1,5-2

E / 0 / P

Gewindetiefe und Lochform
Thread depth and hole type

max. 2,5 x d₁



max. 3 x d₁



Einsatzgebiete – Material
Applications – material

» 22

N 1.1-4

P 1.1-4.1

M 1.1-2.1

N 2.1

P 1.1-4.1

M 1.1-2.1

N 2.1

P 1.1-4.1

M 1.1-3.1

N 1.4-6

N 2.1-2, 2.4-5

S 1.1

Werkzeug-Ident · Tool ident

C050S800

C0503500

C0513500

C0513700

Nenngröße
Nom. size

EG M	Ø d ₁		P	l ₁	l ₂	Ø d ₂		□	Dimens.-Ident
	mm	mm				mm	mm		
10	11,948	1,5	100	15	9	7	10,5	.0975	
12	14,274	1,75	110	20	11	9	12,5	.0977	
14	16,598	2	110	20	12	9	14,5	.0978	
16	18,598	2	125	20	14	11	16,5	.0979	
18	21,248	2,5	140	27	18	14,5	18,75	.0980	
20	23,248	2,5	160	30	18	14,5	20,75	.0981	

DIN 40435



» 217

» 217

» 217

» 217

- Product Finder
- Vc
- M
- MF
- UNC UN-8
- UNF UNEF
- G, Rp NPSM, NPSF
- NPT, NPTF Rc, W
- BSW, BSF
- Pg
- MJ UNJC, UNJF
- EG (STI) SELF-LOCK**
- Tr, Tr-F Rd
- Zubehör Accessories
- Tech. Info

EG UNC (STI)

ASME B18.29.1



≈ DIN 371

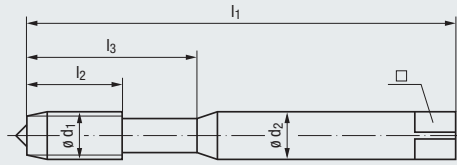

VA
Stainless steel materials



new

Toleranz · Tolerance
Beschichtung · Coating
Schneidstoff · Cutting material

Technische Informationen
Technical information

» 245 - 266



2B	2B	2B
NT	TIN	GLT-1
HSSE	HSSE	HSSE
B / 4-5	B / 4-5	B / 4-5
E / O / P	E / O / P	E / O / P

Gewindetiefe und Lochform
Thread depth and hole type

max. 3 x d₁



Einsatzgebiete – Material
Applications – material

» 22

P 1.1-3.1	P 1.1-4.1	P 1.1-4.1
M 1.1-2.1	M 1.1-3.1	M 1.1-3.1
K 2.1	K 2.1	K 2.1
N 2.2, 2.5-6	N 2.2, 2.5-6	N 2.2

Werkzeug-Ident · Tool ident

B0203000 B0203100 B020C300

Nenngröße Nom. size	Ø d ₁		P Gg/1" (tpi)	l ₁	l ₂	l ₃	Ø d ₂		□	Dimens.- Ident
	mm									
EG Nr. 4	3,671		40	63	13	21	4,5	3,4	3,1	.5611
Nr. 6	4,536		32	70	14	25	6	4,9	3,8	.5613
Nr. 8	5,197		32	80	16	30	6	4,9	4,4	.5614
Nr. 10	6,200		24	80	17	30	7	5,5	5,2	.5615
1/4	8,002		20	90	20	35	8	6,2	6,7	.5617
5/16	9,771		18	100	22	39	10	8	8,4	.5618

≈ DIN 376



» 222

» 222

» 222

EG UNC (STI)

ASME B18.29.1

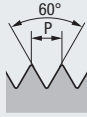

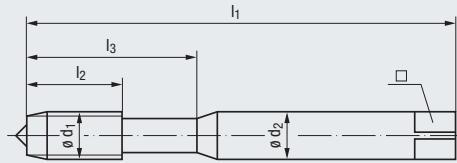

≈ DIN 371



<p>AL Aluminium wrought alloys</p> <p>new</p> 	<p>Z CNC-controlled machines</p>  	

- Product Finder
- Vc
- M
- MF
- UNC UN-8
- UNF UNEF
- G, Rp NPSM, NPSF
- NPT, NPTF Rc, W
- BSW, BSF
- Pg
- MJ UNJC, UNJF
- EG (STI) SELF-LOCK**
- Tr, Tr-F Rd
- Zubehör Accessories
- Tech. Info

<p>Technische Informationen Technical information</p> <p>» 245 - 266</p>	<p>Toleranz · Tolerance</p> <p>Beschichtung · Coating</p> <p>Schneidstoff · Cutting material</p> 	<p>2B</p> <p>GLT-8</p> <p>HSSE</p> <p>R45</p> <p>C / 2-3</p> <p>E / O</p>	<p>2B</p> <p>2B</p> <p>TIN</p> <p>HSSE</p> <p>R45</p> <p>E / 1,5-2</p> <p>E / O / P</p>	<p>2B</p> <p>TIN</p> <p>HSSE</p> <p>R45</p> <p>E / 1,5-2</p> <p>E / O / P</p>

<p>Gewindetiefe und Lochform Thread depth and hole type</p>	<p>max. 2,5 x d₁</p> 	<p>max. 3 x d₁</p> 
---	---	---

<p>Einsatzgebiete – Material Applications – material</p> <p>» 22</p>	<p>N 1.1-4</p>	<p>P 1.1-4.1</p> <p>M 1.1-2.1</p> <p>N 2.1</p>	<p>P 1.1-4.1</p> <p>M 1.1-3.1</p> <p>N 1.4-6</p> <p>N 2.1-2, 2.4-5</p> <p>S 1.1</p>
--	-----------------------	---	--

Werkzeug-Ident · Tool ident										B050S800	B0513500	B0513700	
Nenngröße Nom. size										Dimens.- Ident	Enorm 1-AL GLT-8	Enorm 1-Z/E	Enorm 1-Z/E TIN
Ø d ₁	Ø d ₁ mm	P Gg/1" (tpi)	l ₁	l ₂	l ₃	Ø d ₂	□						
EG Nr. 4	3,671	40	63	7	21	4,5	3,4	3,1	.5611	●	●	●	
Nr. 6	4,536	32	70	8	25	6	4,9	3,8	.5613	●	●	●	
Nr. 8	5,197	32	80	8	30	6	4,9	4,4	.5614	●	●	●	
Nr. 10	6,200	24	80	10	30	7	5,5	5,2	.5615	●	●	●	
1/4	8,002	20	90	14	35	8	6,2	6,7	.5617	●	●	●	
5/16	9,771	18	100	16	39	10	8	8,4	.5618	●	●	●	

≈ DIN 376 

» 223 

- Product Finder
- Vc
- M
- MF
- UNC UN-8
- UNF UNEF
- G, Rp NPSM, NPSF
- NPT, NPTF Rc, W
- BSW, BSF
- Pg
- MJ UNJC, UNJF
- EG (STI)** SELF-LOCK
- Tr, Tr-F Rd
- Zubehör Accessories
- Tech. Info

EG UNC (STI)

ASME B18.29.1



≈ DIN 376

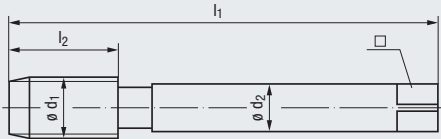

VA
Stainless steel materials



new

Toleranz · Tolerance
Beschichtung · Coating
Schneidstoff · Cutting material

Technische Informationen
Technical information

» 245 - 266



2B	2B	2B
NT	TIN	GLT-1
HSSE	HSSE	HSSE
B / 4-5	B / 4-5	B / 4-5
E / O / P	E / O / P	E / O / P

Gewindetiefe und Lochform
Thread depth and hole type

max. 3 x d₁



Einsatzgebiete – Material
Applications – material

» 22

P 1.1-3.1	P 1.1-4.1	P 1.1-4.1
M 1.1-2.1	M 1.1-3.1	M 1.1-3.1
K 2.1	K 2.1	K 2.1
N 2.2, 2.5-6	N 2.2, 2.5-6	N 2.2

Werkzeug-Ident · Tool ident

C0203000 C0203100 C020C300

Nenngröße Nom. size	Dimens.-Ident							Rekord 2B-VA NT	Rekord 2B-VA TIN	Rekord 2B-VA GLT-1
	Ø d ₁	Ø d ₁ mm	P Gg/1" (tpi)	l ₁	l ₂	Ø d ₂	□			
EG 3/8	11,587	16	100	22	9	7	10	●	●	○
7/16	13,469	14	110	26	11	9	11,6	●	●	○
1/2	15,237	13	110	27	12	9	13,3	●	●	○
9/16	17,039	12	110	27	12	9	14,9	●	●	○
5/8	18,875	11	125	30	14	11	16,5	●	●	○
3/4	22,349	10	140	32	18	14,5	19,75	●	●	○

≈ DIN 371



» 220

» 220

» 220

EG UNC (STI)

ASME B18.29.1

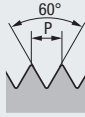

≈ DIN 376

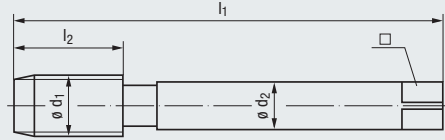

Technische Informationen
Technical information

» 245 - 266

Toleranz · Tolerance
Beschichtung · Coating
Schneidstoff · Cutting material



Gewindetiefe und Lochform
Thread depth and hole type

Einsatzgebiete – Material
Applications – material

» 22

Werkzeug-Ident · Tool ident

Nenngröße
Nom. size

EG	Ø d ₁	Ø d ₁ mm	P Gg/1" (tpi)	l ₁	l ₂	Ø d ₂	□	Dimens.- Ident	Enorm	
									2-Z/E	2-Z/E TIN
	3/8	11,587	16	100	15	9	7	.5619	●	●
	7/16	13,469	14	110	20	11	9	.5620	○	○
	1/2	15,237	13	110	22	12	9	.5621	●	●
	9/16	17,039	12	110	22	12	9	.5622	○	○
	5/8	18,875	11	125	25	14	11	.5623	●	●
	3/4	22,349	10	140	27	18	14,5	.5624	●	●

≈ DIN 371



» 221

» 221

Z CNC-controlled machines	
2B	2B
HSSE	TIN
R45	HSSE
E / 1,5-2	R45
E / O / P	E / 1,5-2
E / O / P	E / O / P

max. 3 x d ₁	
-------------------------	--

P 1.1-4.1	P 1.1-4.1
M 1.1-2.1	M 1.1-3.1
N 2.1	N 1.4-6
	N 2.1-2, 2.4-5
	S 1.1

C0513500	C0513700
----------	----------

- Product Finder
- V_c
- M
- MF
- UNC UN-8
- UNF UNEF
- G, Rp NPSM, NPSF
- NPT, NPTF Rc, W
- BSW, BSF
- Pg
- MJ UNJC, UNJF
- EG (STI) SELF-LOCK**
- Tr, Tr-F Rd
- Zubehör Accessories
- Tech. Info

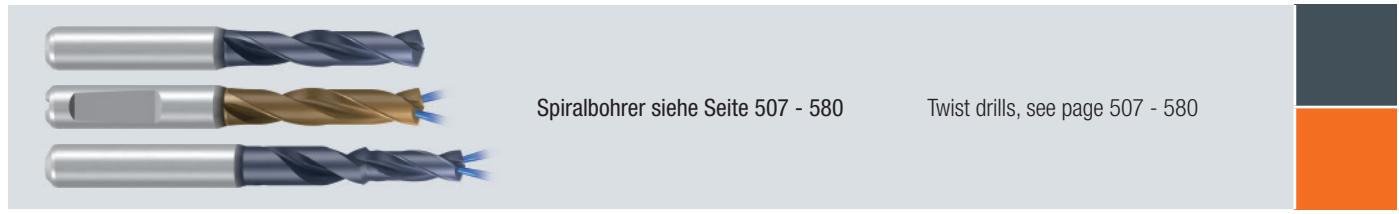
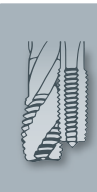

Spiralbohrer siehe Seite 507 - 580

Twist drills, see page 507 - 580

- Product Finder
- Vc
- M
- MF
- UNC UN-8
- UNF UNEF
- G, Rp NPSM, NPSF
- NPT, NPTF Rc, W
- BSW, BSF
- Pg
- MJ UNJC, UNJF
- EG (STI) SELF-LOCK**
- Tr, Tr-F Rd
- Zubehör Accessories
- Tech. Info

EG UNF (STI)

ASME B18.29.1

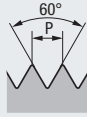

≈ DIN 371

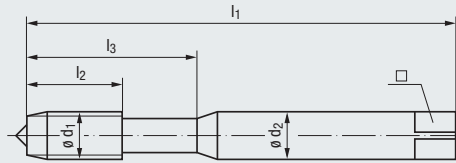

VA
Stainless steel materials



new

Toleranz · Tolerance
Beschichtung · Coating
Schneidstoff · Cutting material

Technische Informationen
Technical information

» 245 - 266



2B	2B	2B
NT	TIN	GLT-1
HSSE	HSSE	HSSE
B / 4-5	B / 4-5	B / 4-5
E / O / P	E / O / P	E / O / P

Gewindetiefe und Lochform
Thread depth and hole type

max. 3 x d₁



Einsatzgebiete – Material
Applications – material

» 22

P 1.1-3.1	P 1.1-4.1	P 1.1-4.1
M 1.1-2.1	M 1.1-3.1	M 1.1-3.1
K 2.1	K 2.1	K 2.1
N 2.2, 2.5-6	N 2.2, 2.5-6	N 2.2

Werkzeug-Ident · Tool ident

B0203000 B0203100 B020C300

Nenngröße Nom. size	P			l				□	Dimens.- Ident
	Ø d ₁	Ø d ₁ mm	Gg/1" (tpi)	l ₁	l ₂	l ₃	Ø d ₂		
EG Nr. 4	3,533	48	56	9	20	4	3	3	.5633
Nr. 6	4,330	40	70	11	25	6	4,9	3,7	.5635
Nr. 8	5,083	36	80	13	30	6	4,9	4,4	.5636
Nr. 10	5,858	32	80	13	30	6	4,9	5,1	.5637
1/4	7,528	28	90	17	35	8	6,2	6,6	.5639
5/16	9,312	24	90	18	35	10	8	8,25	.5640

≈ DIN 374



» 226 » 226 » 226

EG UNF (STI)

ASME B18.29.1

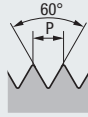

≈ DIN 371

AL
Aluminium wrought alloys



Z
CNC-controlled machines

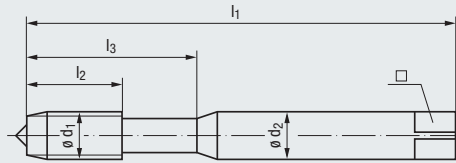
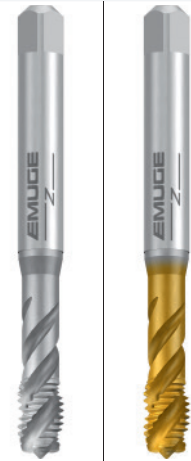

Technische Informationen
Technical information

» 245 - 266

Toleranz · Tolerance
Beschichtung · Coating
Schneidstoff · Cutting material



- 2B
- GLT-8
- HSSE
- R45
- C / 2-3
- E / O

- | | |
|------------------|------------------|
| 2B | 2B |
| HSSE | TIN |
| HSSE | HSSE |
| R45 | R45 |
| E / 1,5-2 | E / 1,5-2 |
| E / O / P | E / O / P |

Gewindetiefe und Lochform
Thread depth and hole type

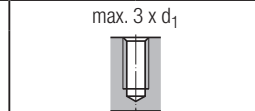
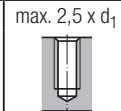

Einsatzgebiete – Material
Applications – material

» 22

N 1.1-4

- | | |
|------------------|-----------------------|
| P 1.1-4.1 | P 1.1-4.1 |
| M 1.1-2.1 | M 1.1-3.1 |
| N 2.1 | N 1.4-6 |
| | N 2.1-2, 2.4-5 |
| | S 1.1 |

Werkzeug-Ident · Tool ident

B050S800 **B0513500** **B0513700**

Nenngröße Nom. size	ø d ₁ mm	P Gg/1" (tpi)	l ₁	l ₂	l ₃	ø d ₂	□	Dimens.- Ident	Enorm		
									1-AL GLT-8	1-Z/E	1-Z/E TIN
EG Nr. 4	3,533	48	56	7	20	4	3	.5633	●	●	●
Nr. 6	4,330	40	70	8	25	6	4,9	.5635	●	●	●
Nr. 8	5,083	36	80	8	30	6	4,9	.5636	●	●	●
Nr. 10	5,858	32	80	8	30	6	4,9	.5637	●	●	●
1/4	7,528	28	90	10	35	8	6,6	.5639	●	●	●
5/16	9,312	24	90	10	35	10	8,25	.5640	●	●	●

≈ DIN 374



» 227

» 227

- Product Finder
- Vc
- M
- MF
- UNC UN-8
- UNF UNEF
- G, Rp NPSM, NPSF
- NPT, NPTF Rc, W
- BSW, BSF
- Pg
- MJ UNJC, UNJF
- EG (STI) SELF-LOCK**
- Tr, Tr-F Rd
- Zubehör Accessories
- Tech. Info



- Product Finder
- Vc
- M
- MF
- UNC UN-8
- UNF UNEF
- G, Rp NPSM, NPSF
- NPT, NPTF Rc, W
- BSW, BSF
- Pg
- MJ UNJC, UNJF
- EG (STI)** SELF-LOCK
- Tr, Tr-F Rd
- Zubehör Accessories
- Tech. Info

EG UNF (STI)

ASME B18.29.1

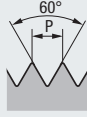

≈ DIN 374

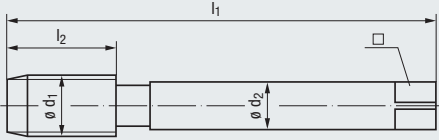

VA
Stainless steel materials



new

Technische Informationen
Technical information

» 245 - 266

Toleranz · Tolerance
Beschichtung · Coating
Schneidstoff · Cutting material



2B	2B	2B
NT	TIN	GLT-1
HSSE	HSSE	HSSE
B / 4-5	B / 4-5	B / 4-5
E / O / P	E / O / P	E / O / P

Gewindetiefe und Lochform
Thread depth and hole type

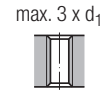

Einsatzgebiete – Material
Applications – material

» 22

P 1.1-3.1	P 1.1-4.1	P 1.1-4.1
M 1.1-2.1	M 1.1-3.1	M 1.1-3.1
K 2.1	K 2.1	K 2.1
N 2.2, 2.5-6	N 2.2, 2.5-6	N 2.2

Werkzeug-Ident · Tool ident

C0203000 C0203100 C020C300

Nenngröße Nom. size								Dimens.- Ident	Rekord 2B-VA NT	Rekord 2B-VA TIN	Rekord 2B-VA GLT-1
	Ø d ₁	Ø d ₁ mm	P Gg/1" (tpi)	l ₁	l ₂	Ø d ₂	□				
EG 3/8	10,899	24	90	18	8	6,2	9,8	.5641	●	●	○
7/16	12,763	20	100	22	9	7	11,5	.5642	●	●	○
1/2	14,352	20	100	22	11	9	13,1	.5643	●	●	○
9/16	16,121	18	100	22	12	9	14,7	.5644	●	●	○
5/8	17,709	18	110	25	14	11	16,25	.5645	●	●	○
3/4	21,112	16	125	25	16	12	19,5	.5646	●	●	○

≈ DIN 371



» 224

» 224

» 224

EG UNF (STI)

ASME B18.29.1

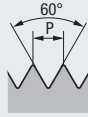

≈ DIN 374

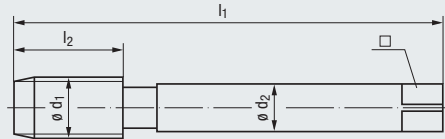

Technische Informationen
Technical information

» 245 - 266

Toleranz · Tolerance
Beschichtung · Coating
Schneidstoff · Cutting material



2B	2B
HSSE	TIN
R45	HSSE
E / 1,5-2	E / 1,5-2
E / O / P	E / O / P

Gewindetiefe und Lochform
Thread depth and hole type

max. 3 x d₁



Einsatzgebiete – Material
Applications – material

» 22

P 1.1-4.1	P 1.1-4.1
M 1.1-2.1	M 1.1-3.1
N 2.1	N 1.4-6
	N 2.1-2, 2.4-5
	S 1.1

Werkzeug-Ident · Tool ident

C0513500 C0513700

Nenngröße Nom. size	Ø d ₁ mm	P Gg/1" (tpi)	l ₁	l ₂	Ø d ₂	□	Ø d ₁	Ø d ₂	Dimens.- Ident	Enorm 2-Z/E	
										Enorm 2-Z/E	Enorm 2-Z/E TIN
EG 3/8	10,899	24	90	11	8	6,2	9,8	9,8	.5641	●	●
7/16	12,763	20	100	13	9	7	11,5	11,5	.5642	○	○
1/2	14,352	20	100	15	11	9	13,1	13,1	.5643	●	●
9/16	16,121	18	100	15	12	9	14,7	14,7	.5644	○	○
5/8	17,709	18	110	17	14	11	16,25	16,25	.5645	●	●
3/4	21,112	16	125	17	16	12	19,5	19,5	.5646	●	●

≈ DIN 371



» 225

» 225

Product Finder

V_c

M

MF

UNC
UN-8

UNF
UNEF

G, Rp
NPSM, NPSF

NPT, NPTF
Rc, W

BSW, BSF

Pg

MJ
UNJC, UNJF

EG (STI)
SELF-LOCK

Tr, Tr-F
Rd

Zubehör
Accessories

Tech. Info



- Product Finder
- Vc
- M
- MF
- UNC UN-8
- UNF UNEF
- G, Rp NPSM, NPSF
- NPT, NPTF Rc, W
- BSW, BSF
- Pg
- MJ UNJC, UNJF
- EG (STI) SELF-LOCK
- Tr, Tr-F Rd
- Zubehör Accessories
- Tech. Info

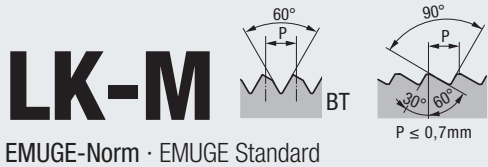

DIN 371

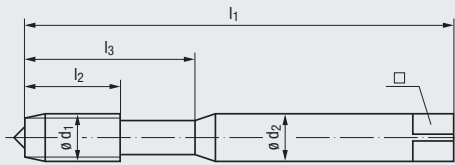

Technische Informationen Technical information ▶ 245 - 266	Toleranz · Tolerance	NT	TIN	GLT-1	NT
	Beschichtung · Coating	HSSE	HSSE	HSSE	HSSE
	Schneidstoff · Cutting material	B / 4-5	B / 4-5	B / 4-5	C / 2-3
		E / O / P	E / O / P	E / O / P	E

Gewindetiefe und Lochform Thread depth and hole type	max. 3 x d ₁	max. 2 x d ₁		

Einsatzgebiete – Material Applications – material ▶ 22	P 1.1-3.1	P 1.1-4.1	P 1.1-4.1	K 1.1-2
	M 1.1-2.1	M 1.1-3.1	M 1.1-3.1	
	K 2.1	K 2.1	K 2.1	
	N 2.2, 2.5-6	N 2.2, 2.5-6	N 2.2	

Werkzeug-Ident · Tool ident										B0203000	B0203100	B020C300	B0102000
Ø d ₁ mm	P mm	l ₁	l ₂	l ₃	Ø d ₂	□		Dimens.-Ident	Rekord 1B-VA NT	Rekord 1B-VA TIN	Rekord 1B-VA GLT-1	Rekord 1A-GG NT	
									LK-M	3	0,5	56	11
	4	0,7	63	13	21	4,5	3,4	3,55				○	
	5	0,8	70	15	25	6	4,9	4,4	●	○	○	○	
	6	1	80	17	30	6	4,9	5,2	●	●	○	●	
	8	1,25	90	20	35	8	6,2	7	●	●	○	●	
	10	1,5	100	22	39	10	8,8	8,8	●	●	○	●	

DIN 376 230 230 230 230

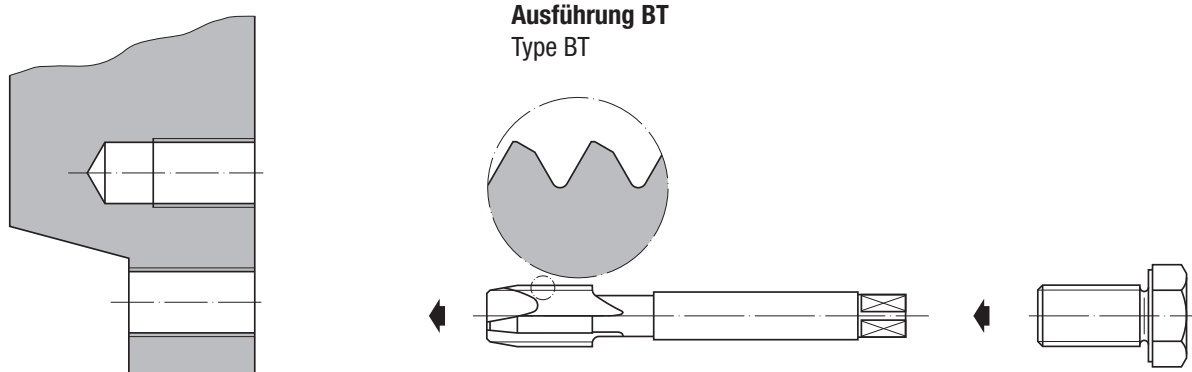

BT = Keilfläche nach hinten geneigt
BT = Wedge ramp inclined backwards

LK-M

EMUGE-Norm · EMUGE Standard

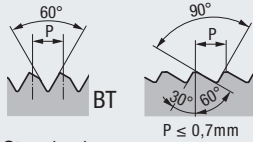

DIN 371

AL
Aluminium wrought alloys

new



Z
CNC-controlled machines

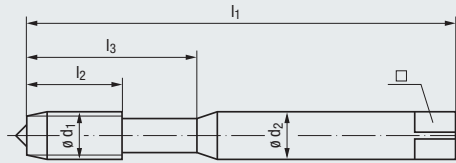

Technische Informationen
Technical information

» 245 - 266

Toleranz · Tolerance
Beschichtung · Coating
Schneidstoff · Cutting material



GLT-8

HSSE

R45

C / 2-3

E / O

TIN

HSSE

R45

E / 1,5-2

E / O / P

HSSE

R45

E / 1,5-2

E / O / P

Gewindetiefe und Lochform
Thread depth and hole type

max. 2,5 x d₁



max. 3 x d₁



Einsatzgebiete – Material
Applications – material

» 22

N 1.1-4

P 1.1-4.1

M 1.1-2.1

N 2.1

P 1.1-4.1

M 1.1-3.1

N 1.4-6

N 2.1-2, 2.4-5

S 1.1

Werkzeug-Ident · Tool ident

B050S800

B0513500

B0513700

LK-M	∅ d ₁ mm	P mm	l ₁	l ₂	l ₃	∅ d ₂	□	Image	Dimens.- Ident	Enorm		
										1-AL GLT-8	1-Z/E	1-Z/E TIN
	3	0,5	56	6	18	3,5	2,7	2,7	.1046	●	●	○
	4	0,7	63	7	21	4,5	3,4	3,55	.1048	●	●	○
	5	0,8	70	8	25	6	4,9	4,4	.1050	●	●	○
	6	1	80	10	30	6	4,9	5,2	.1052	●	●	●
	8	1,25	90	14	35	8	6,2	7	.1054	●	●	●
	10	1,5	100	16	39	10	8	8,8	.1056	●	●	●

DIN 376



» 231

» 231

- Product Finder
- V_c
- M
- MF
- UNC UN-8
- UNF UNEF
- G, Rp NPSM, NPSF
- NPT, NPTF Rc, W
- BSW, BSF
- Pg
- MJ UNJC, UNJF
- EG (ST) SELF-LOCK
- Tr, Tr-F Rd
- Zubehör Accessories
- Tech. Info



- Product Finder
- Vc
- M
- MF
- UNC UN-8
- UNF UNEF
- G, Rp NPSM, NPSF
- NPT, NPTF Rc, W
- BSW, BSF
- Pg
- MJ UNJC, UNJF
- EG (STI) SELF-LOCK
- Tr, Tr-F Rd
- Zubehör Accessories
- Tech. Info



EMUGE-Norm · EMUGE Standard

DIN 376

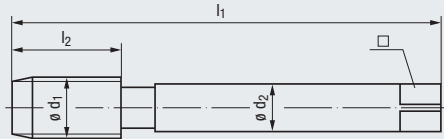

Toleranz · Tolerance
Beschichtung · Coating
Schneidstoff · Cutting material

NT	TIN	GLT-1	NT
HSSE	HSSE	HSSE	HSSE
B / 4-5	B / 4-5	B / 4-5	C / 2-3
E / O / P	E / O / P	E / O / P	E

Technische Informationen
Technical information

» 245 - 266

Gewindetiefe und Lochform
Thread depth and hole type



Einsatzgebiete – Material
Applications – material

» 22

P 1.1-3.1	P 1.1-4.1	P 1.1-4.1	K 1.1-2
M 1.1-2.1	M 1.1-3.1	M 1.1-3.1	
K 2.1	K 2.1	K 2.1	
N 2.2, 2.5-6	N 2.2, 2.5-6	N 2.2	

Werkzeug-Ident · Tool ident

C0203000 C0203100 C020C300 C0102000

LK-M	Ø d ₁ mm	P mm	l ₁	l ₂	Ø d ₂	□	Dimens.-Ident	Rekord 2B-VA NT	Rekord 2B-VA TIN	Rekord 2B-VA GLT-1	Rekord 2A-GG NT
								●	●	○	○
	12	1,75	110	24	9	7	.1058	●	●	○	○
	14	2	110	26	11	9	.1059	●	●	○	○
	16	2	110	27	12	9	.1060	●	●	○	○
	20	2,5	140	32	16	12	.1062	●	●	○	○
	24	3	160	34	18	14,5	.1064	●	●	○	○

DIN 371 228 228 228 228

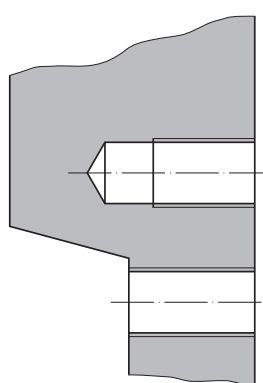

Ausführung BT
Type BT

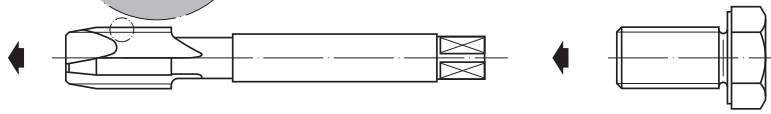

BT = Keilfläche nach hinten geneigt
BT = Wedge ramp inclined backwards

LK-M

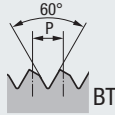

EMUGE-Norm · EMUGE Standard

DIN 376

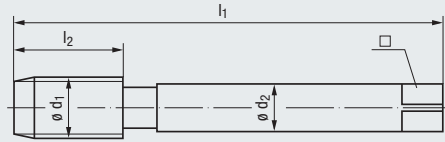

Z
CNC-controlled machines



Product Finder

V_c

M

MF

UNC
UN-8

UNF
UNEF

G, Rp
NPSM, NPSF

NPT, NPTF
Rc, W

BSW, BSF

Pg

MJ
UNJC, UNJF

EG (STI)
SELF-LOCK

Tr, Tr-F
Rd

Zubehör
Accessories

Tech. Info

Technische Informationen
Technical information

» 245 - 266

Toleranz · Tolerance
Beschichtung · Coating
Schneidstoff · Cutting material



- | | |
|------------------|------------------|
| HSSE | TIN |
| R45 | HSSE |
| E / 1,5-2 | E / 1,5-2 |
| E / O / P | E / O / P |

Gewindetiefe und Lochform
Thread depth and hole type

max. 3 x d₁



Einsatzgebiete – Material
Applications – material

» 22

- | | |
|------------------|-----------------------|
| P 1.1-4.1 | P 1.1-4.1 |
| M 1.1-2.1 | M 1.1-3.1 |
| N 2.1 | N 1.4-6 |
| | N 2.1-2, 2.4-5 |
| | S 1.1 |

Werkzeug-Ident · Tool ident

C0513500 C0513700

	Ø d ₁ mm	P mm	l ₁	l ₂	Ø d ₂	□		Dimens.- Ident	Enorm 2-Z/E	
									Enorm 2-Z/E	Enorm 2-Z/E TIN
LK-M	12	1,75	110	18	9	7	10,7	.1058	●	●
	14	2	110	20	11	9	12,5	.1059		
	16	2	110	22	12	9	14,5	.1060	●	●
	20	2,5	140	25	16	12	18	.1062	○	○
	24	3	160	30	18	14,5	21,5	.1064	○	○

DIN 371



» 229

» 229

- Product Finder
- Vc
- M
- MF
- UNC UN-8
- UNF UNEF
- G, Rp NPSM, NPSF
- NPT, NPTF Rc, W
- BSW, BSF
- Pg
- MJ UNJC, UNJF
- EG (STI) SELF-LOCK
- Tr, Tr-F Rd
- Zubehör Accessories
- Tech. Info



DIN 103

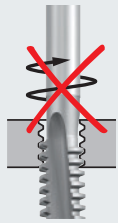

Nicht reversieren!
No reversal!

2-Stufen-Ausführung
2-step design

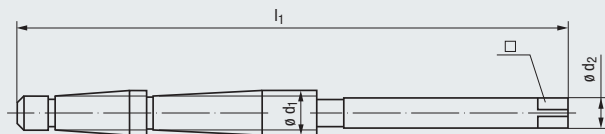

STEEL
Steel materials

Technische Informationen Technical information	▶ 245 - 266	Toleranz · Tolerance	7H	7H
		Beschichtung · Coating	HSSE	HSSE
		Schneidstoff · Cutting material	L05	LH, R05
			0	0

Gewindetiefe und Lochform Thread depth and hole type	max. 2 x d ₁ ¹⁾	

Einsatzgebiete – Material Applications – material	▶ 22	P 1.1-3.1	P 1.1-3.1
		K 1.1-2	K 1.1-2
		N 2.2-3, 2.6	N 2.2-3, 2.6

Werkzeug-Ident · Tool ident								G0351000	G0351050
Ø d ₁ mm	P mm	l ₁	Ø d ₂	□		Dimens.-Ident	TRAPEZ 2Stuf STEEL	TRAPEZ 2Stuf STEEL-LH	
Tr 8	x 1,5	105	6	4,9	6,6	.7040	○	○	
9	x 2	130	7	5,5	7,2	.7042	○	○	
10	x 2	130	7	5,5	8,2	.7043	○	○	
10	x 3	155	7	5,5	7,25	.7044	○	○	
11	x 3	155	8	6,2	8,25	.7045	○	○	
12	x 3	160	9	7	9,25	.7046	○	○	
14	x 3	170	10	8	11,25	.7047	○	○	
14	x 4	195	10	8	10,25	.7048	○	○	
16	x 4	225	12	9	12,25	.7051	○	○	
18	x 4	225	14	11	14,25	.7052	○	○	
20	x 4	225	16	12	16,25	.7053	○	○	
22	x 5	260	16	12	17,25	.7054	○	○	
24	x 5	285	18	14,5	19,25	.7055	○	○	
26	x 5	285	20	16	21,25	.7057	○	○	
28	x 5	300	22	18	23,25	.7058	○	○	
30	x 6	335	22	18	24,25	.7059	○	○	
32	x 6	335	25	20	26,25	.7060	○	○	
34	x 6	350	28	22	28,25	.7061	○	○	
36	x 6	350	28	22	30,25	.7062	○	○	
38	x 7	385	28	22	31,5	.7063	○	○	
40	x 7	400	32	24	33,5	.7064	○	○	
42	x 7	400	32	24	35,5	.7065	○	○	
44	x 7	410	36	29	37,5	.7066	○	○	
46	x 8	440	36	29	38,5	.7067	○	○	
48	x 8	455	40	32	40,5	.7068	○	○	
50	x 8	470	40	32	42,5	.7069	○	○	
52	x 8	470	40	32	44,5	.7070	○	○	



DIN 103

NC

VA
Stainless steel materials



Muss mit zwangsläufiger Steigung geschnitten werden
Positive feed control is necessary

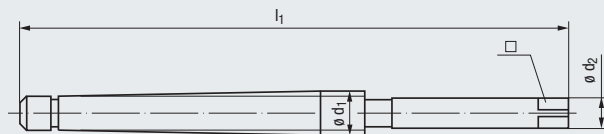

Technische Informationen
Technical information

» 245 - 266

Toleranz · Tolerance
Beschichtung · Coating
Schneidstoff · Cutting material



Gewindetiefe und Lochform
Thread depth and hole type

max. 1,5 x d₁



Einsatzgebiete – Material
Applications – material

» 22

P	1.1-3.1	P	1.1-3.1
M	1.1-2.1	M	1.1-2.1
K	2.1-4.2	K	2.1-4.2
N	2.4-6	N	2.4-6

Werkzeug-Ident · Tool ident

G0303000	G0303050
TRAPEZ AM-VA NT	TRAPEZ AM-VA-LH NT

Tr	ø d ₁ mm	x	P mm	l ₁	ø d ₂	□	 Dimens.-Ident					
	8	x	1,5	90	6	4,9	6,6	.7040	○	○		
	9	x	2	110	7	5,5	7,2	.7042	○	○		
	10	x	2	110	7	5,5	8,2	.7043	○	○		
	10	x	3	130	7	5,5	7,25	.7044	○	○		
	11	x	3	130	8	6,2	8,25	.7045	○	○		
	12	x	3	140	9	7	9,25	.7046	○	○		
	14	x	3	145	10	8	11,25	.7047	○	○		
	14	x	4	165	10	8	10,25	.7048	○	○		
	16	x	4	190	12	9	12,25	.7051	○	○		
	18	x	4	195	14	11	14,25	.7052	○	○		
	20	x	4	195	16	12	16,25	.7053	○	○		
	22	x	5	220	16	12	17,25	.7054	○	○		
	24	x	5	245	18	14,5	19,25	.7055	○	○		
	26	x	5	245	20	16	21,25	.7057	○	○		
	28	x	5	260	22	18	23,25	.7058	○	○		
	30	x	6	285	22	18	24,25	.7059	○	○		

- Product Finder
- V_c
- M
- MF
- UNC UN-8
- UNF UNEF
- G, Rp NPSM, NPSF
- NPT, NPTF Rc, W
- BSW, BSF
- Pg
- MJ UNJC, UNJF
- EG (ST) SELF-LOCK
- Tr, Tr-F Rd
- Zubehör Accessories
- Tech. Info



- Product Finder
- Vc
- M
- MF
- UNC UN-8
- UNF UNEF
- G, Rp NPSM, NPSF
- NPT, NPTF Rc, W
- BSW, BSF
- Pg
- MJ UNJC, UNJF
- EG (STI) SELF-LOCK
- Tr, Tr-F Rd
- Zubehör Accessories
- Tech. Info



DIN 103

≈ DIN 352

MS
Copper-zinc alloys



Speziell für Drehautomaten
Specially made for automatic lathes

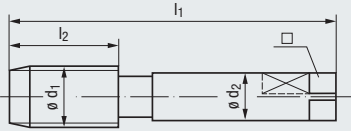

Technische Informationen
Technical information

» 245 - 266

Toleranz · Tolerance
Beschichtung · Coating
Schneidstoff · Cutting material



7H

HSSE

E / 1,5-2

0

Gewindetiefe und Lochform
Thread depth and hole type

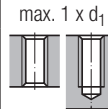

N 2.3

Einsatzgebiete – Material
Applications – material

» 22

Werkzeug-Ident · Tool ident

G0442500

Tr	ø d ₁ mm	P mm	l ₁	l ₂	ø d ₂	□	Image	Dimens.- Ident	TRAPEZ AUT-A MS				
	8	x 1,5	70	22	8 ¹⁾	6,2	6,6	.7040	○				
	8	x 2	70	22	8 ¹⁾	6,2	6,2	.7041	○				
	9	x 2	70	22	8 ¹⁾	6,2	7,2	.7042	○				
	10	x 2	70	22	8 ¹⁾	6,2	8,2	.7043	○				
	10	x 3	70	22	8 ¹⁾	6,2	7,25	.7044	○				
	11	x 3	75	24	9	7	8,25	.7045	○				
	12	x 3	75	25	9	7	9,25	.7046	○				
	14	x 3	80	26	10 ¹⁾	8	11,25	.7047	○				
	14	x 4	80	26	10 ¹⁾	8	10,25	.7048	○				
	16	x 4	80	27	12	9	12,25	.7051	○				
	18	x 4	95	32	12 ¹⁾	9	14,25	.7052	○				
	20	x 4	95	32	15 ¹⁾	12	16,25	.7053	○				

¹⁾ Spezieller AUT-Schaft
Special shank for "AUT" taps

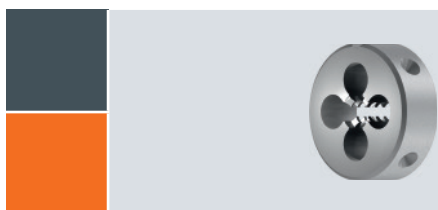

Schneideisen für Trapez-Gewinde
siehe Seite 496 - 497

Dies for trapezoidal threads,
see page 496 - 497

Tr-F

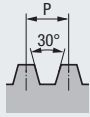

DIN 103

≈ DIN 374/376

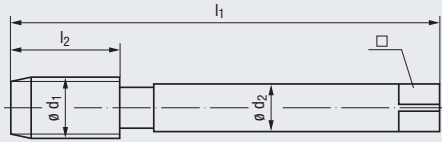

STEEL
Steel materials



VA
Stainless steel materials



Technische Informationen
Technical information

» 245 - 266

Toleranz · Tolerance
Beschichtung · Coating
Schneidstoff · Cutting material



7H	7H	7H
HSSE	HSSE	NT
L15	LH, R15	HSSE
0	0	L25
		0

Gewindetiefe und Lochform
Thread depth and hole type

max. 2 x d₁ 2)



max. 2 x d₁



Einsatzgebiete – Material
Applications – material

» 22

P 1.1-2.1	P 1.1-2.1	P 1.1-3.1
		M 1.1-2.1
		K 2.1-4.2
		N 2.4-6

Werkzeug-Ident · Tool ident

G0321000 G0321050 G0323000

Tr	ø d ₁ mm	P mm	l ₁	l ₂	ø d ₂	□	 Dimens.-Ident	TRAPEZ	TRAPEZ	TRAPEZ
								Rekord 2C-STEEL	Rekord 2C-STEEL LH	Rekord 2C-VA NT
	9	x 1,5	100	22	7	5,5	7,6	○	○	○
	10	x 1,5	100	22	7	5,5	8,6	○	○	○
	11	x 2	100	22	8	6,2	9,2	○	○	○
	12	x 2	110	25	9	7	10,2	○	○	○
	14	x 2	110	26	11	9	12,2	○	○	○
	16	x 2	110	27	12	9	14,2	○	○	○
	18	x 2	125	27	14	11	16,2	○	○	○
	20	x 2	140	27	16	12	18,2	○	○	○
	22	x 3	160	34	18	14,5	19,25	○	○	○
	24	x 3	160	36	18	14,5	21,25	○	○	○
	26	x 3	160	36	20	16	23,25	○	○	○
	28	x 3	180	40	22	18	25,25	○	○	○
	30	x 3	180	40	22	18	27,25	○	○	○

2) Bei entsprechender Einspannlänge bis ca. 2,5 x d₁
With sufficient clamping length up to approx. 2.5 x d₁

3) Muss mit zwangsläufiger Steigung geschnitten werden
Positive feed control is necessary

- Product Finder
- V_c
- M
- MF
- UNC UN-8
- UNF UNEF
- G, Rp NPSM, NPSF
- NPT, NPTF Rc, W
- BSW, BSF
- Pg
- MJ UNJC, UNJF
- EG (ST) SELF-LOCK
- Tr, Tr-F Rd
- Zubehör Accessories
- Tech. Info



- Product Finder
- Vc
- M
- MF
- UNC UN-8
- UNF UNEF
- G, Rp NPSM, NPSF
- NPT, NPTF Rc, W
- BSW, BSF
- Pg
- MJ UNJC, UNJF
- EG (STI) SELF-LOCK
- Tr, Tr-F Rd
- Zubehör Accessories
- Tech. Info

Tr-F

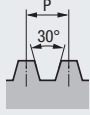

≈ DIN 352

DIN 103

Speziell für Drehautomaten
Specially made for automatic lathes

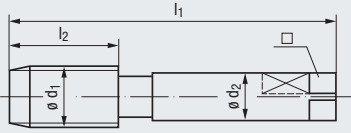

MS
Copper-zinc alloys



Technische Informationen
Technical information

» 245 - 266

Toleranz · Tolerance
Beschichtung · Coating
Schneidstoff · Cutting material

7H

HSSE

E / 1,5-2

0



Gewindetiefe und Lochform
Thread depth and hole type

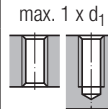

Einsatzgebiete – Material
Applications – material

» 22

N 2.3

Werkzeug-Ident · Tool ident

G0442500

Tr	Ø d ₁ mm	P mm	l ₁	l ₂	Ø d ₂	□	Image of Tap	Dimens.-Ident	TRAPEZ AUT-A MS				
	9	x 1,5	70	22	8 ¹⁾	6,2	7,6	.7111	○				
	10	x 1,5	70	22	8 ¹⁾	6,2	8,6	.7112	○				
	11	x 2	75	24	9	7	9,2	.7128	○				
	12	x 2	75	25	9	7	10,2	.7129	○				
	14	x 2	80	26	10 ¹⁾	8	12,2	.7130	○				
	16	x 2	80	27	12	9	14,2	.7132	○				
	18	x 2	80	22	12 ¹⁾	9	16,2	.7133	○				
	20	x 2	80	22	15 ¹⁾	12	18,2	.7134	○				
	22	x 3	100	32	15 ¹⁾	12	19,25	.7156	○				
	24	x 3	110	36	18	14,5	21,25	.7157	○				
	26	x 3	110	36	18	14,5	23,25	.7159	○				
	28	x 3	125	36	18 ¹⁾	14,5	25,25	.7160	○				
	30	x 3	125	34	18 ¹⁾	14,5	27,25	.7161	○				

1) Spezieller AUT-Schaft
Special shank for "AUT" taps



Rd

DIN 405

≈ DIN 352

STEEL
Steel materials

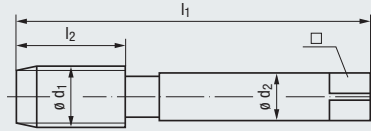

Technische Informationen
Technical information

» 245 - 266

Toleranz · Tolerance
Beschichtung · Coating
Schneidstoff · Cutting material



7H

HSSE

C / 2-3

0

Gewindetiefe und Lochform
Thread depth and hole type

max. 1 x d₁

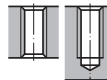

Einsatzgebiete – Material
Applications – material

» 22

P 1.1-2.1
K 1.1-4.2
N 2.2-3

Werkzeug-Ident · Tool ident

G0401000

Rd	Ø d ₁ mm	P Gg/1" (tpi)	l ₁	l ₂	Ø d ₂	□		Dimens.- Ident	RUND Rekord A-STEEL				
	8	x 10	70	22	8	6,2	6	.7287	○				
	9	x 10	70	22	8	6,2	7	.7288	○				
	10	x 10	70	22	8	6,2	8	.7289	○				
	11	x 10	70	22	8	6,2	9	.7290	○				
	12	x 10	75	25	9	7	10	.7291	○				
	14	x 8	80	26	11	9	11,5	.7293	○				
	16	x 8	80	27	12	9	13,5	.7294	○				
	18	x 8	95	32	14	11	15,5	.7295	○				
	20	x 8	95	32	16	12	17,5	.7296	○				
	22	x 8	100	32	18	14,5	19,5	.7297	○				
	24	x 8	110	36	18	14,5	21,5	.7298	○				
	26	x 8	110	36	20	16	23,5	.7299	○				
	28	x 8	125	34	22	18	25,5	.7300	○				
	30	x 8	125	34	22	18	27,5	.7301	○				

- Product Finder
- V_c
- M
- MF
- UNC UN-8
- UNF UNEF
- G, Rp NPSM, NPSF
- NPT, NPTF Rc, W
- BSW, BSF
- Pg
- MJ UNJC, UNJF
- EG (STI) SELF-LOCK
- Tr, Tr-F Rd
- Zubehör Accessories
- Tech. Info

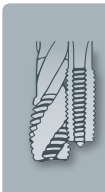

Gewindelehren
siehe Seite 581 - 654

Thread gauges,
see page 581 - 654

- Product Finder
- Vc
- M
- MF
- UNC UN-8
- UNF UNEF
- G, Rp NPSM, NPSF
- NPT, NPTF Rc, W
- BSW, BSF
- Pg
- MJ UNJC, UNJF
- EG (STI) SELF-LOCK
- Tr, Tr-F Rd
- Zubehör Accessories



		Gewindeschneidöle, chlorfrei	Thread cutting oils, chlorine-free						
	<table border="1"> <tr><td>P</td><td>M</td></tr> <tr><td>K</td><td>N</td></tr> <tr><td>S</td><td>H</td></tr> </table>	P	M	K	N	S	H	Für Stahlwerkstoffe Kann sowohl für Pinsel- als auch für Umlaufschmierung verwendet werden.	For steel materials Can be used for brush and circulation lubrication.
P	M								
K	N								
S	H								
	<table border="1"> <tr><td>P</td><td>M</td></tr> <tr><td>K</td><td>N</td></tr> <tr><td>S</td><td>H</td></tr> </table>	P	M	K	N	S	H	Für Gusswerkstoffe Kann sowohl für Pinsel- als auch für Umlaufschmierung verwendet werden.	For cast materials Can be used for brush and circulation lubrication.
P	M								
K	N								
S	H								
	<table border="1"> <tr><td>P</td><td>M</td></tr> <tr><td>K</td><td>N</td></tr> <tr><td>S</td><td>H</td></tr> </table>	P	M	K	N	S	H	Für nahezu alle Werkstoffe Als Emulsion im Mischungsverhältnis 1:8 einzusetzen. Kann auch im unverdünnten Zustand verwendet werden. Für die Bearbeitung von Kupferwerkstoffen nur bedingt geeignet!	For almost all materials For use as emulsion in a mixing ratio of 1:8. Can be used in undiluted state also. Limited suitability for the machining of copper materials!
P	M								
K	N								
S	H								
	<table border="1"> <tr><td>P</td><td>M</td></tr> <tr><td>K</td><td>N</td></tr> <tr><td>S</td><td>H</td></tr> </table>	P	M	K	N	S	H	Für Nichteisen-Werkstoffe Kann sowohl für Pinsel- als auch für Umlaufschmierung verwendet werden.	For non ferrous materials Can be used for brush and circulation lubrication.
P	M								
K	N								
S	H								
	<table border="1"> <tr><td>P</td><td>M</td></tr> <tr><td>K</td><td>N</td></tr> <tr><td>S</td><td>H</td></tr> </table>	P	M	K	N	S	H	Für schwer zerspanbare Werkstoffe Zum Gewindeformen hervorragend geeignet. Kann sowohl für Pinsel- als auch für Umlaufschmierung verwendet werden. Für die Bearbeitung von Buntmetall nicht geeignet!	For difficult materials Perfectly suitable for the cold forming of threads. Can be used for brush and circulation lubrication. Not suitable for the machining of non-ferrous materials!
P	M								
K	N								
S	H								
		Gewindeschneidpaste, chlorfrei	Thread cutting paste, chlorine-free						
	<table border="1"> <tr><td>P</td><td>M</td></tr> <tr><td>K</td><td>N</td></tr> <tr><td>S</td><td>H</td></tr> </table>	P	M	K	N	S	H	Für schwer zerspanbare Werkstoffe Zum Gewindeformen hervorragend geeignet. Besonders vorteilhaft bei waagrechter Bearbeitung, großen Abmessungen und Durchgangslochgewinden. Kann nur für Pinselschmierung verwendet werden. Für die Bearbeitung von Buntmetall nur bedingt geeignet!	For difficult materials Perfectly suitable for the cold forming of threads. Especially useful in horizontal machining, with large thread sizes and through hole threads. To be used only for brush lubrication. Limited suitability for the machining of non-ferrous materials!
P	M								
K	N								
S	H								

Besondere Bedeutung sollte bei der Herstellung von Gewinden dem Kühlschmierstoff zugeordnet werden. EMUGE-Kühlschmierstoffe sind speziell auf den zu bearbeitenden Werkstoff bzw. auf die vorhandenen Arbeitsbedingungen abgestimmt.

In the production of threads, special attention should always be paid to the use of coolant-lubricant. EMUGE coolant-lubricants are specially designed for the materials they are recommended for, and for typical modern work conditions as known from our experience.

Nr. No.	Gebinde Container size	Artikel-Nr. Article no.	
1+ STEEL	1 kg	FZ191015.01	●
	5 kg	FZ191015.05	●
	10 kg	FZ191015.10	●
	20 kg	FZ191015.20	●
2+ CAST IRON	1 kg	FZ191115.01	●
	5 kg	FZ191115.05	●
	10 kg	FZ191115.10	●
	20 kg	FZ191115.20	●
3+ EMULSION	1 kg	FZ191215.01	●
	5 kg	FZ191215.05	●
	10 kg	FZ191215.10	●
	20 kg	FZ191215.20	●

Nr. No.	Gebinde Container size	Artikel-Nr. Article no.	
4+ NON FERROUS	1 kg	FZ191315.01	●
	5 kg	FZ191315.05	●
	10 kg	FZ191315.10	●
	20 kg	FZ191315.20	●
5+ HIGH ALLOY	1 kg	FZ191415.01	●
	5 kg	FZ191415.05	●
	10 kg	FZ191415.10	●
	20 kg	FZ191415.20	●
6+ PASTE	0,45 kg	FZ191515.005	●
	4,5 kg	FZ191515.05	●

- Product Finder
- Vc
- M
- MF
- UNC UN-8
- UNF UNEF
- G, Rp NPSM, NPSF
- NPT, NPTF Rc, W
- BSW, BSF
- Pg
- MJ UNJC, UNJF
- EG (ST) SELF-LOCK
- Tr, Tr-F Rd
- Zubehör Accessories
- Tech. Info



● = Lagerwerkzeug, siehe Preisliste · Stock tool, see price list
 ○ = Kurzfristig lieferbar, Preis auf Anfrage · Available on short notice, price upon inquiry



- Product Finder
- V_c
- M
- MF
- UNC UN-8
- UNF UNEF
- G, Rp NPSM, NPSF
- NPT, NPTF Rc, W
- BSW, BSF
- Pg
- MJ UNJC, UNJF
- EG (STI) SELF-LOCK
- Tr, Tr-F Rd
- Zubehör Accessories
- Tech. Info



Für den Einsatz auf CNC-Maschinen und herkömmlichen Gewindeschneideinrichtungen
 For use on CNC machines and conventional thread cutting machinery

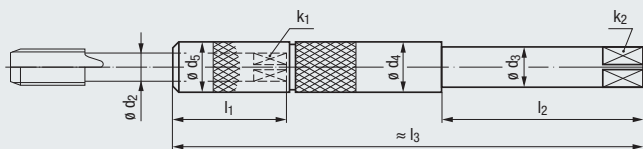

Kurze Ausführung Short design

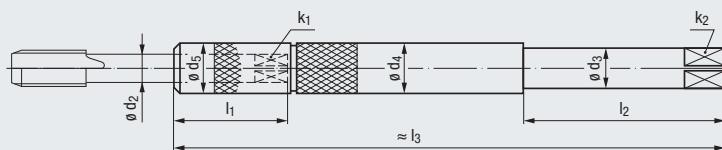

Größe Size	Baumaße Gewindebohrer / Gewindeformer Dimensions of tap / cold-forming tap				Baumaße Schaftverlängerung Dimensions of extension						Artikel-Nr. Article no.	
	$\varnothing d_2$	k_1			l_1	$\varnothing d_3$ h9	k_2 h12	l_2	$\varnothing d_4 / d_5$	l_3		
1	2,8	2,1	M 2 - M2,6	M 4	21	6	4,9	60	6,1	130	FZ111300.01	●
2	3,5	2,7	M 3	M 4,5 - M5	22	6	4,9	60	7,5	130	FZ111300.02	●
3	4	3	M 3,5	M 5,5	22	6	4,9	60	8,4	130	FZ111300.03	●
4	4,5	3,4	M 4	M 6	22	6	4,9	60	8,4	130	FZ111300.04	●
5	6	4,9	M 4,5 - M6	M 8	25	7	5,5	60	12,1	130	FZ111300.05	●
6	7	5,5	M 7	M 9 - M10	25	7	5,5	60	12,1	130	FZ111300.06	●
7	8	6,2	M 8	M11	29	8	6,2	60	13	130	FZ111300.07	●
8	9	7	M 9	M12	30	9	7	60	15	130	FZ111300.08	●
9	10	8	M10	—	32	10	8	60	15	130	FZ111300.09	●
10	11	9	—	M14	35	11	9	90	18	180	FZ111300.10	●
11	12	9	(M12)	M16	35	12	9	90	18	180	FZ111300.11	●
12	14	11	—	M18	39	14	11	90	22	180	FZ111300.12	●
13	16	12	—	M20	40	16	12	90	22	180	FZ111300.13	●
14	18	14,5	—	M22 - M24	42	18	14,5	100	26	200	FZ111300.14	●
15	20	16	—	M27	44	20	16	100	28	200	FZ111300.15	●
16	22	18	—	M30	46	22	18	100	30	200	FZ111300.16	●
17	25	20	—	M33	49	25	20	100	35	200	FZ111300.17	●

Lange Ausführung Long design



Größe Size	Baumaße Gewindebohrer / Gewindeformer Dimensions of tap / cold-forming tap				Baumaße Schaftverlängerung Dimensions of extension						Artikel-Nr. Article no.	
	$\varnothing d_2$	k_1			l_1	$\varnothing d_3$ h9	k_2 h12	l_2	$\varnothing d_4 / d_5$	l_3		
1	2,8	2,1	M 2 - M2,6	M 4	21	6	4,9	65	6,1	230	FZ111310.01	●
2	3,5	2,7	M 3	M 4,5 - M5	22	6	4,9	70	7,5	230	FZ111310.02	●
3	4	3	M 3,5	M 5,5	22	6	4,9	70	8,4	230	FZ111310.03	●
4	4,5	3,4	M 4	M 6	22	6	4,9	70	8,4	230	FZ111310.04	●
5	6	4,9	M 4,5 - M6	M 8	25	7	5,5	70	12,1	230	FZ111310.05	●
6	7	5,5	M 7	M 9 - M10	25	7	5,5	70	12,1	230	FZ111310.06	●
7	8	6,2	M 8	M11	29	8	6,2	80	13	230	FZ111310.07	●
8	9	7	M 9	M12	30	9	7	80	15	230	FZ111310.08	●
9	10	8	M10	—	32	10	8	80	15	230	FZ111310.09	●
10	11	9	—	M14	35	11	9	90	18	330	FZ111310.10	●
11	12	9	(M12)	M16	35	12	9	90	18	330	FZ111310.11	●
12	14	11	—	M18	39	14	11	90	22	330	FZ111310.12	●
13	16	12	—	M20	40	16	12	90	22	330	FZ111310.13	●
14	18	14,5	—	M22 - M24	42	18	14,5	100	26	330	FZ111310.14	●
15	20	16	—	M27	44	20	16	100	28	330	FZ111310.15	●
16	22	18	—	M30	46	22	18	100	30	330	FZ111310.16	●
17	25	20	—	M33	49	25	20	100	35	330	FZ111310.17	●



Ersatz-Spannkappen oder Sechskant-Spannkappen auf Anfrage
 Spare clamping nuts or hexagon clamping nuts are available upon request

Für den Einsatz auf CNC-Maschinen und herkömmlichen Gewindeschneideinrichtungen
For use on CNC machines and conventional thread cutting machinery

Kurze Ausführung, mit innerer Kühlschmierstoff-Zufuhr
Short design, with internal coolant supply

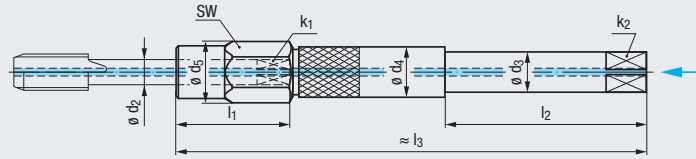

IKZ

p_{max}
50bar
(700psi)

Größe Size	Baumaße Gewindebohrer / Gewindeformer Dimensions of tap / cold-forming tap				Baumaße Schaftverlängerung Dimensions of extension							Spannkappe Clamping nut		Artikel-Nr. Article no.	new
	Ø d ₂	k ₁			l ₁	Ø d ₃ h ₉	k ₂ h ₁₂	l ₂	Ø d ₄	Ø d ₅	l ₃	SW (W/F)	M _d ¹⁾ Nm		
1	2,8	2,1	M 2 - M2,6	M 4	21	6	4,9	60	6,1	6,5	130	6	2	FZ112600.01	●
2	3,5	2,7	M 3	M 4,5 - M5	22	6	4,9	60	7,5	9	130	8	2	FZ112600.02	●
3	4	3	M 3,5	M 5,5	22	6	4,9	60	8,4	10	130	9	2,5	FZ112600.03	●
4	4,5	3,4	M 4	M 6	22	6	4,9	60	8,4	10	130	9	3	FZ112600.04	●
5	6	4,9	M 4,5 - M6	M 8	25	7	5,5	60	12,1	13,5	130	12	3,5	FZ112600.05	●
6	7	5,5	M 7	M 9 - M10	25	7	5,5	60	12,1	13,5	130	12	5	FZ112600.06	●
7	8	6,2	M 8	M11	29	8	6,2	60	13	14,5	130	13	6	FZ112600.07	●
8	9	7	M 9	M12	30	9	7	60	15	16,5	130	15	8	FZ112600.08	●
9	10	8	M10	-	32	10	8	60	15	16,5	130	15	11	FZ112600.09	●
10	11	9	-	M14	35	11	9	90	18	20	180	18	15	FZ112600.10	●
11	12	9	(M12)	M16	35	12	9	90	18	20	180	18	20	FZ112600.11	●
12	14	11	-	M18	39	14	11	90	22	25	180	22	25	FZ112600.12	●
13	16	12	-	M20	40	16	12	90	22	25	180	22	33	FZ112600.13	●
14	18	14,5	-	M22 - M24	42	18	14,5	100	26	29	200	26	45	FZ112600.14	●
15	20	16	-	M27	44	20	16	100	28	32	200	28	60	FZ112600.15	●
16	22	18	-	M30	46	22	18	100	30	34	200	30	77	FZ112600.16	●
17	25	20	-	M33	49	25	20	100	35	41	200	36	100	FZ112600.17	●

Lange Ausführung, mit innerer Kühlschmierstoff-Zufuhr
Long design, with internal coolant supply

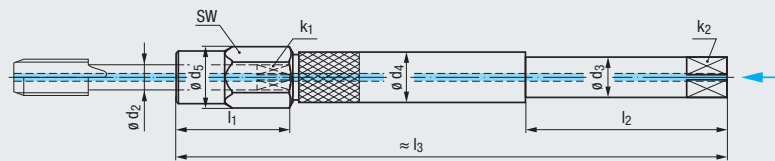

IKZ

p_{max}
50bar
(700psi)

Größe Size	Baumaße Gewindebohrer / Gewindeformer Dimensions of tap / cold-forming tap				Baumaße Schaftverlängerung Dimensions of extension							Spannkappe Clamping nut		Artikel-Nr. Article no.	new
	Ø d ₂	k ₁			l ₁	Ø d ₃ h ₉	k ₂ h ₁₂	l ₂	Ø d ₄	d ₅	l ₃	SW (W/F)	M _d ¹⁾ Nm		
1	2,8	2,1	M 2 - M2,6	M 4	21	6	4,9	65	6,1	6,5	230	6	2	FZ112610.01	●
2	3,5	2,7	M 3	M 4,5 - M5	22	6	4,9	70	7,5	9	230	8	2	FZ112610.02	●
3	4	3	M 3,5	M 5,5	22	6	4,9	70	8,4	10	230	9	2,5	FZ112610.03	●
4	4,5	3,4	M 4	M 6	22	6	4,9	70	8,4	10	230	9	3	FZ112610.04	●
5	6	4,9	M 4,5 - M6	M 8	25	7	5,5	70	12,1	13,5	230	12	3,5	FZ112610.05	●
6	7	5,5	M 7	M 9 - M10	25	7	5,5	70	12,1	13,5	230	12	5	FZ112610.06	●
7	8	6,2	M 8	M11	29	8	6,2	80	13	14,5	230	13	6	FZ112610.07	●
8	9	7	M 9	M12	30	9	7	80	15	16,5	230	15	8	FZ112610.08	●
9	10	8	M10	-	32	10	8	80	15	16,5	230	15	11	FZ112610.09	●
10	11	9	-	M14	35	11	9	90	18	20	330	18	15	FZ112610.10	●
11	12	9	(M12)	M16	35	12	9	90	18	20	330	18	20	FZ112610.11	●
12	14	11	-	M18	39	14	11	90	22	25	330	22	25	FZ112610.12	●
13	16	12	-	M20	40	16	12	90	22	25	330	22	33	FZ112610.13	●
14	18	14,5	-	M22 - M24	42	18	14,5	100	26	29	330	26	45	FZ112610.14	●
15	20	16	-	M27	44	20	16	100	28	32	330	28	60	FZ112610.15	●
16	22	18	-	M30	46	22	18	100	30	34	330	30	77	FZ112610.16	●
17	25	20	-	M33	49	25	20	100	35	41	330	36	100	FZ112610.17	●



Ersatz-Sechskant-Spannkappen auf Anfrage
Spare hexagon clamping nuts are available upon request

¹⁾ empfohlenes Anzugsdrehmoment
Recommend tightening torque



Drehmomentschlüssel TORCO-FIX und Aufsteckschlüssel A-SW siehe Seite 795
Torque wrenches TORCO-FIX and shell-type wrenches A-SW, see page 795

Product Finder

V_c

M

MF

UNC UN-8

UNF UNEF

G, Rp NPSM, NPSF

NPT, NPTF Rc, W

BSW, BSF

Pg

MJ UNJC, UNJF

EG (STI) SELF-LOCK

Tr, Tr-F Rd

Zubehör Accessories

Tech. Info

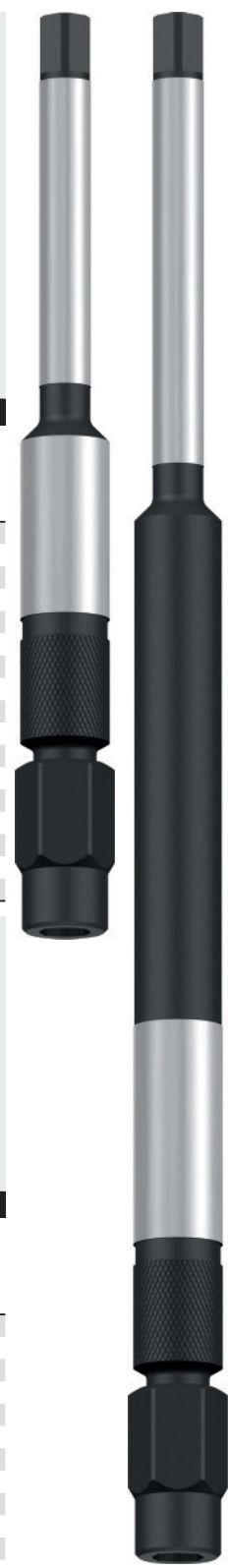
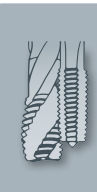

- Product Finder
- Vc
- M
- MF
- UNC UN-8
- UNF UNEF
- G, Rp NPSM, NPSF
- NPT, NPTF Rc, W
- BSW, BSF
- Pg
- MJ UNJC, UNJF
- EG (STI) SELF-LOCK
- Tr, Tr-F Rd
- Zubehör Accessories
- Tech. Info



Für den Einsatz auf CNC-Maschinen und herkömmlichen Gewindeschneideeinrichtungen
 For use on CNC machines and conventional thread cutting machinery

Kurze Ausführung, mit innerer Kühlschmierstoff-Zufuhr
 Short design, with internal coolant supply

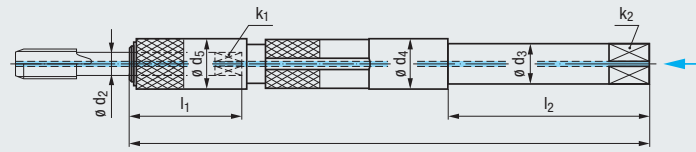

IKZ

p_{max}
 50bar
 (700psi)

Größe Size	Baumaße Gewindebohrer / Gewindeformer Dimensions of tap / cold-forming tap				Baumaße Schaftverlängerung Dimensions of extension						Rillenform Slot shape	Artikel-Nr. Article no.	
	$\varnothing d_2$	k_1			l_1	$\varnothing d_3$ h6	k_2 h12	l_2	$\varnothing d_4 / d_5$	l_3			
4	4,5	3,4	M 4	M 6	23	10	8	60	12,1	160	A	FZ115490.04	○
5	6	4,9	M 4,5 - M6	M 8	25	10	8	60	12,1	160	A	FZ115490.05	○
7	8	6,2	M 8	M11	29	12	9	60	13	160	A	FZ115510.07	○
8	9	7	M 9	M12	30	12	9	60	15	160	A	FZ115510.08	○
9	10	8	M10	-	32	12	9	60	15	160	A	FZ115510.09	○
11	12	9	(M12)	M16	35	16	12	60	18	160	B	FZ115530.11	○

Lange Ausführung, mit innerer Kühlschmierstoff-Zufuhr
 Long design, with internal coolant supply

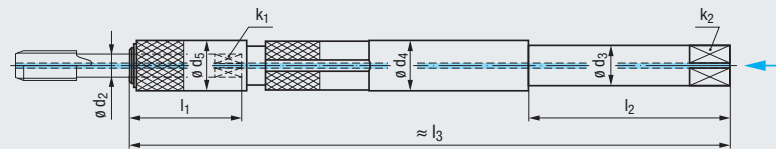

IKZ

p_{max}
 50bar
 (700psi)

Größe Size	Baumaße Gewindebohrer / Gewindeformer Dimensions of tap / cold-forming tap				Baumaße Schaftverlängerung Dimensions of extension						Rillenform Slot shape	Artikel-Nr. Article no.	
	$\varnothing d_2$	k_1			l_1	$\varnothing d_3$ h6	k_2 h12	l_2	$\varnothing d_4 / d_5$	l_3			
4	4,5	3,4	M 4	M 6	23	10	8	100	12,1	230	A	FZ115480.04	○
5	6	4,9	M 4,5 - M6	M 8	25	10	8	100	12,1	230	A	FZ115480.05	○
7	8	6,2	M 8	M11	29	12	9	100	13	230	A	FZ115500.07	○
8	9	7	M 9	M12	30	12	9	100	15	230	A	FZ115500.08	○
9	10	8	M10	-	32	12	9	100	15	230	A	FZ115500.09	○
11	12	9	(M12)	M16	35	16	12	100	18	230	B	FZ115520.11	○

Bearbeitungsmaße für Rillenform am Gewindebohrer-Vierkant
 Machining specifications for the slot shape on the driving square of taps

Form A

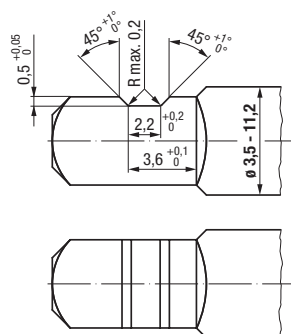

Form B

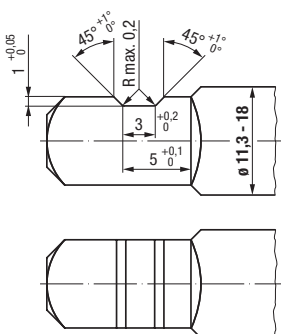

Lehren für E-Lock-Rillenform siehe Seite 763
 Gauges for E-Lock slots, see page 763



Für normale Beanspruchung
For normal use

≈ DIN
1814

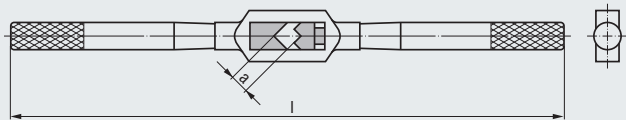

Größe Size	Baumaße Dimensions	Artikel-Nr. Article no.	
	$a_{min.} - a_{max.}$ mm	l	
0	2 - 5	125	●
1	2 - 6	180	●
1 1/2	2,5 - 8	200	●
2	4 - 9	280	●
3	4,9 - 12	375	●
4	5,5 - 16	500	●
5	7 - 20	750	●

Für starke Beanspruchung
For heavy use

≈ DIN
1814

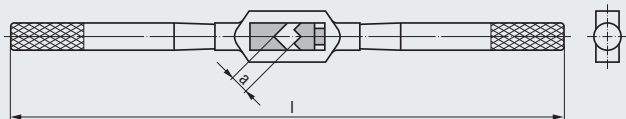

Aus gehärtetem Stahl (Gehäuse: Temperguss oder Stahl geschmiedet)
Made of hardened steel (casing: malleable iron or forged steel)

Größe Size	Baumaße Dimensions	Artikel-Nr. Article no.	
	$a_{min.} - a_{max.}$ mm	l	
0	2 - 5	125	●
1	2 - 6	180	●
1 1/2	2,5 - 8	200	●
2	4 - 9	280	●
3	4,9 - 12	375	●
4	5,5 - 16	500	●
5	7 - 20	750	●
6	9 - 25	1000	●
7	16 - 32	1250	●

- Product Finder
- V_c
- M
- MF
- UNC UN-8
- UNF UNEF
- G, Rp NPSM, NPSF
- NPT, NPTF Rc, W
- BSW, BSF
- Pg
- MJ UNJC, UNJF
- EG (ST) SELF-LOCK
- Tr, Tr-F Rd
- Zubehör Accessories
- Tech. Info



- Product Finder
- V_c
- M
- MF
- UNC
UN-8
- UNF
UNEF
- G, Rp
NPSM, NPSF
- NPT, NPTF
Rc, W
- BSW, BSF
- Pg
- MJ
UNJC, UNJF
- EG (STI)
SELF-LOCK
- Tr, Tr-F
Rd
- Zubehör
Accessories
- Tech. Info

Für Gewindebohrer mit 3 geraden Nuten
For taps with 3 straight flutes



für Gewinde for thread size	Artikel-Nr. Article no.	
M 3	FZ111100.03/3	●
M 4	FZ111100.04/3	●
M 5	FZ111100.05/3	●
M 6	FZ111100.06/3	●
M 8	FZ111100.08/3	●
M 10	FZ111100.10/3	●
M 12	FZ111100.12/3	●
M 14	FZ111100.14/3	●
M 16	FZ111100.16/3	●
M 20	FZ111100.20/3	●

Andere Ausführungen auf Anfrage
Other designs are available upon request

Für Gewindebohrer mit 4 geraden Nuten
For taps with 4 straight flutes



für Gewinde for thread size	Artikel-Nr. Article no.	
M 8	FZ111100.08/4	●
M 10	FZ111100.10/4	●
M 12	FZ111100.12/4	●
M 16	FZ111100.16/4	●
M 20	FZ111100.20/4	●



Technische Informationen

Technical Information

Seite · Page

1.1	EMUGE Gewindebohrer-Bauformen Constructional designs of our EMUGE taps	246
1.2	Gewindebohrer-Sonderausführungen (Beispiele) Special tap types (examples)	247
1.3	EMUGE Gewindebohrer-Grundformen Basic types of our EMUGE taps	248 - 250
1.4	EMUGE Geometriebezeichnungen Our EMUGE geometries	251 - 253
1.5	EMUGE Oberflächenbehandlungen und -Beschichtungen Our EMUGE surface treatments and coatings	254 - 255
1.6	Sonstige EMUGE-Kurzbezeichnungen Other EMUGE abbreviations	256 - 257
1.7	Anschnittformen Chamfer forms	258
1.8	Kühl- und Schmierstoffe Cooling and lubrication agents	259
1.9	Toleranzfelder des Flankendurchmessers beim Metrischen Gewinde (schematische Darstellung) Tolerance zones of the pitch diameter on the Metric thread (graphic representation)	260
1.10	Toleranzfelder des Flankendurchmessers beim Unified-Gewinde (schematische Darstellung) Tolerance zones of the pitch diameter on the Unified thread (graphic representation)	261
1.11	Berechnung der Schnittdaten Calculation of cutting data	262 - 263
1.12	Schematischer Drehmomentverlauf beim Gewindebohren Schematic of torque curve during a thread cutting process	264
1.13	Technischer Fragebogen: Gewindebohren Technical questionnaire: Tapping of threads	265 - 266

Product
FinderV_c

M

MF

UNC
UN-8UNF
UNEFG, Rp
NPSM, NPSFNPT, NPTF
Rc, W

BSW, BSF

Pg

MJ
UNJC, UNJFEG (STI)
SELF-LOCKTr, Tr-F
RdZubehör
Accessories

Tech. Info





Die Technischen Informationen der jeweiligen Kapitel dieses Kataloges sind in vielen Landessprachen auch als separate Druckerzeugnisse verfügbar. Bitte wenden Sie sich an den für Sie zuständigen Vertriebspartner.

The technical information complementing the various chapters of this catalogue is available also as a separate printed booklet in many different languages. Please speak to your usual sales contact.





- Product Finder
- V_c
- M
- MF
- UNC UN-8
- UNF UNEF
- G, Rp NPSM, NPSF
- NPT, NPTF Rc, W
- BSW, BSF
- Pg
- MJ UNJC, UNJF
- EG (STI) SELF-LOCK
- Tr, Tr-F Rd
- Zubehör Accessories
- Tech. Info**

1.1 EMUGE Gewindebohrer-Bauformen

Bauformen nach DIN (Beispiele)

	Bauform Constructional design	Baumaße Dimensions	EMUGE-Bezeichnung EMUGE designation
	Handgewindebohrer, kurze Maschinen-Gewindebohrer Hand taps, short machine taps	DIN 352 DIN 2181	Rekord Enorm
	Maschinen-Gewindebohrer mit verstärktem Schaft Machine taps with reinforced shank	DIN 371	Rekord 1 Enorm 1
	Maschinen-Gewindebohrer mit durchfallendem Schaft Machine taps with reduced shank	DIN 376 DIN 374	Rekord 2 Enorm 2 Robust 2X

Bauformen nach EMUGE-Werknorm (Beispiele)

	Bauform Constructional design	EMUGE-Bezeichnung EMUGE designation
	Maschinen-Gewindebohrer mit langen Nuten und langem Schaft Machine taps with long flutes and long shank	LF
	Maschinen-Gewindebohrer mit extra langem Schaft Machine taps with extra long shank	LS
	Maschinen-Kombi-Gewindebohrer Machine drill taps	KOMBI
	Trapez-Einschnitt-Gewindebohrer Single finishing trapezoidal taps	TRAPEZ

1.2 Gewindebohrer-Sonderausführungen (Beispiele)

Sonderwerkzeuge nach Kundenwunsch

EMUGE fertigt Spezial-Gewindebohrer nach Kundenzeichnungen und eigenen Konstruktionen.

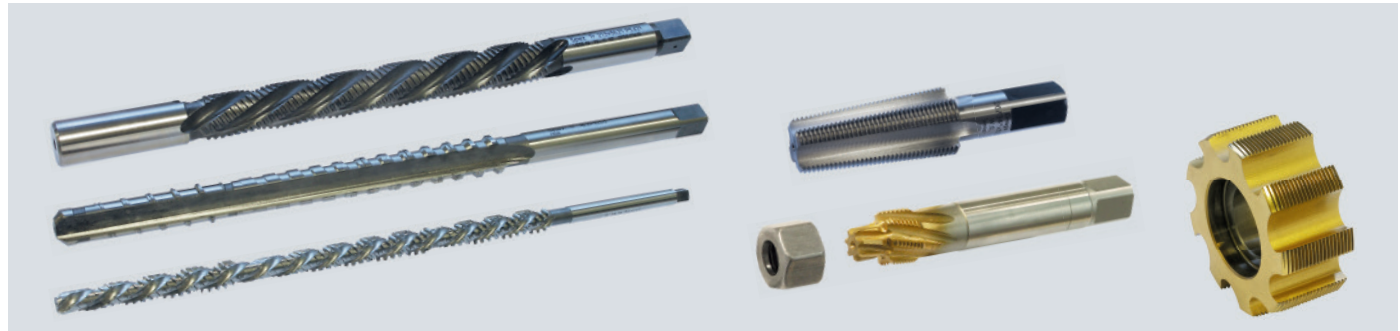

1.2 Special tap types (examples)

Special taps to customers' specifications

EMUGE produces special taps to customers' drawings and proper specifications.

Sondergewinde (Beispiele)

Special threads (examples)

GL

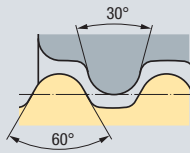

Zylindrisches Rundgewinde
nach DIN 168-1
Cylindrical round thread
acc. DIN 168-1

FG

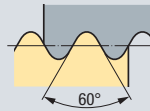

Fahradgewinde
nach DIN 79012
Bicycle thread
acc. DIN 79012

Vg

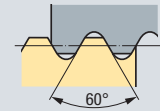

Ventilgewinde
nach DIN 7756
Valve thread
acc. DIN 7756

MFS

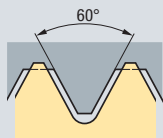

Metrisches ISO-Gewinde für Festsitz
nach DIN 8141-1
ISO Metric thread for tight fit
acc. DIN 8141-1

ST



Blehschraubengewinde
nach DIN EN ISO 1478
Sheet metal screw thread
acc. DIN EN ISO 1478

A/B

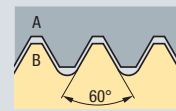

Stativ-Anschlussgewinde
nach DIN 4503
Tripod connection thread
acc. DIN 4503

Tr

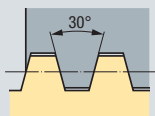

Flaches Metrisches ISO-Trapezgewinde
(ein- und mehrgängig) nach DIN 380-1 und -2
Flat ISO metric trapezoidal thread
(one-start and multi-start) acc. DIN 380-1 and -2

GEWI

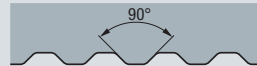

Sonderprofil
Special profile

E



Elektrogewinde
nach DIN 40400
Electrical thread
acc. DIN 40400

S

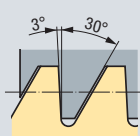

Metrisches Säbengewinde (ein- und mehrgängig)
nach DIN 513-1 bis -3
Metric buttress thread (one-start and multi-start)
acc. DIN 513-1 to -3

M

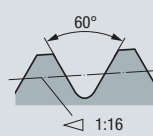

Metrisches kegeliges Außengewinde
nach DIN 158-1
Metric tapered external thread
acc. DIN 158-1

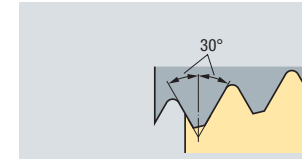

Gewinde für Drahtauslöser
nach DIN 19004
Thread for wire release connection
acc. DIN 19004

Product
Finder

Vc

M

MF

UNC
UN-8UNF
UNEFG, Rp
NPSM, NPSFNPT, NPTF
Rc, W

BSW, BSF

Pg

MJ
UNJC, UNJFEG (ST)
SELF-LOCKTr, Tr-F
RdZubehör
Accessories

Tech. Info



- Product Finder
- Vc
- M
- MF
- UNC UN-8
- UNF UNEF
- G, Rp NPSM, NPSF
- NPT, NPTF Rc, W
- BSW, BSF
- Pg
- MJ UNJC, UNJF
- EG (STI) SELF-LOCK
- Tr, Tr-F Rd

1.3 EMUGE Gewindebohrer-Grundformen

1.3 Basic types of our EMUGE taps

Rekord A

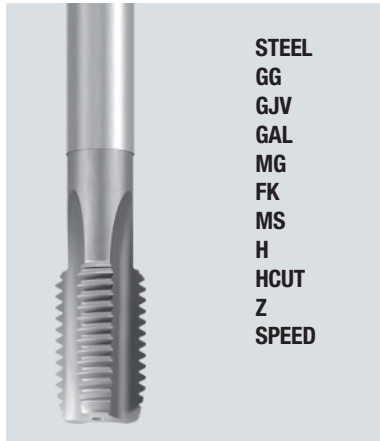

STEEL
GG
GJV
GAL
MG
FK
MS
H
HCUT
Z
SPEED

- Gerade Nutenform
- Anschnittform C (2-3 Gänge)
- Anschnittform E (1,5-2 Gänge)
- Für Grundloch- und Durchgangslochgewinde

Bemerkung:

Vorwiegend für kurzspanendes Material. Die Nuten können nur einen Teil der Späne aufnehmen. Ein Spantransport in Axialrichtung erfolgt praktisch nicht. Tiefe Grundloch- oder Durchgangslochgewinde sollten daher nicht in langspanendes Material gebohrt werden.

- Straight flutes
- Chamfer form C (2-3 threads)
- Chamfer form E (1.5-2 threads)
- For blind hole and through hole threads

Note:

Especially for short-chipping material. The flutes can hold only a part of the chips. There is practically no chip transport in an axial direction. We do not recommend using this tap type in deep blind hole or through hole threads in long-chipping material.

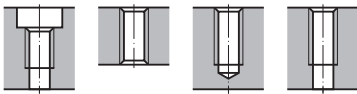

Rekord B



STEEL-L
STEEL-M
STEEL-H
VA
AL
Z
Z-SPEED

- Gerade Nutenform mit Schälanschnitt
- Anschnittform B (4-5 Gänge)
- Für Durchgangslochgewinde

Bemerkung:

Typisches Werkzeug für Durchgangslochgewinde in langspanenden Materialien. Der Schälanschnitt schiebt die Späne eng gerollt nach vorne und verhindert ein Verstopfen der Spannuten. Der Kühlschmierstoff kann ungehindert nachfließen. Nicht im Umkehrschnitt einsetzen!

- Straight flutes with spiral point
- Chamfer form B (4-5 threads)
- For through hole threads

Note:

Typical tool for through hole threads in long-chipping material. The spiral point pushes the tightly rolled chips ahead and prevents clogging of the flutes. Coolant-lubricant can flow freely. Do not use this tap type for a reverse cut!

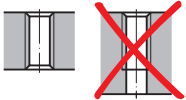

Rekord C

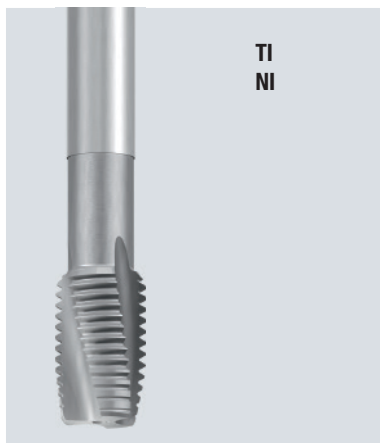

TI
NI

- 8-15° linksgedrahlte Spannuten
- Anschnittform D (4-5 Gänge)
- Für Durchgangslochgewinde

Bemerkung:

Die linksgedrahlten Nuten schieben die Späne nach vorne. Im Gegensatz zur Schälanschnittausführung (Rekord B) verläuft der Spanwinkel über die gesamte Anschnittlänge nahezu konstant. Dies ergibt sehr stabile Anschnittzähne für hochfeste Materialien.

- 8-15° left-hand spiral flutes
- Chamfer form D (4-5 threads)
- For through hole threads

Note:

The left-hand spiral flutes push the chips ahead. As opposed to the spiral-point design (Rekord B), the rake angle remains constant over the complete length of the chamfer. This means extremely stable chamfer teeth for high-strength materials.



1.3 EMUGE Gewindebohrer-Grundformen

1.3 Basic types of our EMUGE taps

Rekord D



STEEL
GAL
PVC
TI
Z

- 10-15° rechtsgedrallte Spannuten
- Anschnittform E (1,5-2 Gänge)
- Anschnittform C (2-3 Gänge)
- Für Grundlochgewinde

Bemerkung:

Vorwiegend auf Drehautomaten und Mehrspindelmaschinen einzusetzen. Auch bei Gewinden mit Aufbohrung sind schwach gedrallte Nuten von Vorteil. Besonders mit innerer Kühlschmierstoff-Zufuhr werden Spanprobleme auf CNC-Maschinen gelöst.

- 10-15° right-hand spiral flutes
- Chamfer form E (1.5-2 threads)
- Chamfer form C (2-3 threads)
- For blind hole threads

Note:

Especially to be recommended on automatic lathes and multi-spindle machines. The slow spiral flutes will be especially helpful in thread holes beginning with an increased diameter (counterbore or enlarged bore). Provided with internal coolant supply, this tap type will help to solve chip problems on CNC machines.

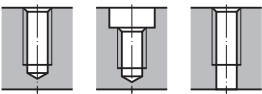

Rekord DF



STEEL
TILLEG
NI

- 10-15° rechtsgedrallte Spannuten
- Zusätzliche Anteilung „F“ (Freischliff)
- Anschnittform C (2-3 Gänge)
- Für Grundlochgewinde

Bemerkung:

Vorwiegend auf Drehautomaten und Mehrspindelmaschinen einzusetzen. Auch bei Gewinden mit Aufbohrung sind schwach gedrallte Nuten von Vorteil. Die zusätzliche Anteilung „F“ (Freischliff) bewirkt enger gerollte bzw. kleiner gebrochene Späne. Besonders mit innerer Kühlschmierstoff-Zufuhr werden Spanprobleme auf CNC-Maschinen gelöst.

- 10-15° right-hand spiral flutes
- Additional helix correction "F" (relief)
- Chamfer form C (2-3 threads)
- For blind hole threads

Note:

Especially to be recommended on automatic lathes and multi-spindle machines. The slow spiral flutes will be especially helpful in thread holes beginning with an increased diameter (counterbore or enlarged bore). The additional helix correction "F" (relief) produces smaller, and tightly rolled chips. Provided with internal coolant supply, this tap type will help to solve chip problems on CNC machines.



Enorm

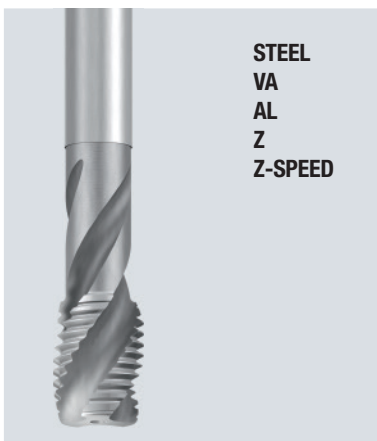

STEEL
VA
AL
Z
Z-SPEED

- 35-50° rechtsgedrallte Spannuten
- Anschnittform E (1,5-2 Gänge)
- Anschnittform C (2-3 Gänge)
- Für Grundlochgewinde in langspanenden Werkstoffen

Bemerkung:

Typisches Werkzeug für Grundlochgewinde in langspanenden Werkstoffen. Durch die stark gedrallten Nuten werden die Späne gut aus dem Grundloch herausgefördert. Je nach Ausführung und Abmessung können bis zu $3 \times d_1$ tiefe Gewinde gebohrt werden. Nicht für Gewinde mit vorgesetzter Aufbohrung geeignet.

- 35-50° right-hand spiral flutes
- Chamfer form E (1.5-2 threads)
- Chamfer form C (2-3 threads)
- For blind hole threads in long-chipping materials

Note:

Typical tool for blind hole threads in long-chipping materials. The fast spiral flutes provide good chip removal from the blind hole. Depending on design and size, threads up to $3 \times d_1$ can be cut. Not to be recommended for threads beginning with an increased diameter.

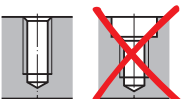
Product
FinderV_c

M

MF

UNC
UN-8UNF
UNEFG, Rp
NPSM, NPSFNPT, NPTF
Rc, W

BSW, BSF

Pg

MJ
UNJC, UNJFEG (ST)
SELF-LOCKTr, Tr-F
RdZubehör
Accessories

Tech. Info



- Product Finder
- Vc
- M
- MF
- UNC UN-8
- UNF UNEF
- G, Rp NPSM, NPSF
- NPT, NPTF Rc, W
- BSW, BSF
- Pg
- MJ UNJC, UNJF
- EG (STI) SELF-LOCK
- Tr, Tr-F Rd
- Zubehör Accessories
- Tech. Info

1.3 EMUGE Gewindebohrer-Grundformen

1.3 Basic types of our EMUGE taps

Robust 2X

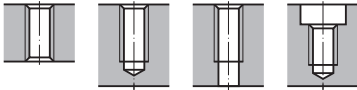

- Mit stirnseitiger Aussparung
- Anschnittform C (2-3 Gänge)
- Für Grundloch- und Durchgangslochgewinde

Bemerkung:

Die speziell ausgebildete Schneidenkrone gibt diesem Werkzeug bereits beim Anschneiden eine hervorragende Eigenführung. Sehr saubere und maßgenaue Gewinde werden dadurch geschnitten. Das Spanmaterial wird bei Grundlochgewinden in der stirnseitigen Aussparung (Spanglocke) aufgenommen. Dieses Werkzeug ist bevorzugt mit Pastenschmierung einzusetzen. Hierbei muss neben dem Werkzeug auch die Bohrungswandung eingestrichen werden! Ölschmierung ist nur bei senkrechter Bearbeitung möglich, wenn das Grundloch mit Öl vollgefüllt ist.

- Provided with a hollow face
- Chamfer form C (2-3 threads)
- For blind hole and through hole threads

Note:

The special crown-shaped front portion of this tool provides excellent accuracy even in the first stage of the cutting process. Extra clean and accurate threads can be cut in this way. The swarf is collected in the hollow face of the tap (internal chip collector) when cutting blind hole threads. For this tool, we recommend using paste lubrication wherever possible. Please make sure to cover not only the tool but also the walls of the hole with paste! Oil lubrication is possible only in vertical machining, if the blind hole can be completely filled with oil.

KOMBI

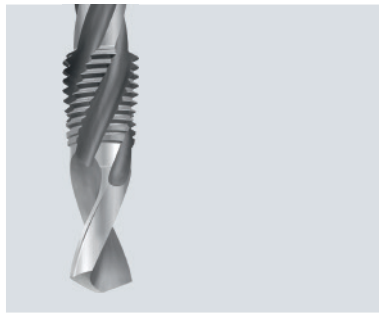

- Ca. 25° rechtsgedrallte Spannuten
- Anschnittform C (2-3 Gänge)
- Für Durchgangslochgewinde (max. 1 x d₁)

Bemerkung:

Kombiniertes Werkzeug zum Kernloch- und Gewindebohren von Durchgangslochgewinden in einem Arbeitsgang, ohne Werkzeugwechsel. Wir empfehlen den Einsatz auf Maschinen mit umschaltbaren Drehzahlen zum Kernloch- und Gewindebohren. Der Vorschub ist der jeweiligen Bearbeitung anzupassen. Werkzeug-Aufnahmen mit Längenausgleich auf Druck sind nicht verwendbar.

- Approx. 25° right-hand spiral flutes
- Chamfer form C (2-3 threads)
- For through hole threads (max. 1 x d₁)

Note:

Combination tool for drilling the thread hole and cutting the thread in through holes in one work process, without tool change. We recommend the use on machines with adjustable speed for drilling and thread cutting. Feed must be adjusted to the respective work process. Tool holders with length compensation on compression are not suitable for this tool type.

MMB



- Gerade Nutenform
- Anschnittlänge ca. 2/3 der Gewindelänge
- Für Durchgangslochgewinde (max. 1,5 x d₁)

Bemerkung:

Maschinen-Mutter-Gewindebohrer nach DIN 357 zum Gewindebohren von Muttern. Für den Einsatz auf Automaten bieten wir auf Anfrage geeignete Werkzeuge an.

- Straight flutes
- Chamfer length approx. 2/3 of thread length
- For through hole threads (max. 1.5 x d₁)

Note:

Machine nut taps acc. DIN 357 for the tapping of nuts. We can also offer you suitable tools for the use on automatic tapping machines.

Set

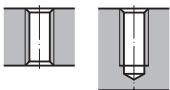

- Gerade Nutenform
- Anschnittform C (2-3 Gänge) beim Fertigschneider
- Für Grundloch- und Durchgangslochgewinde

Bemerkung:

Zum Gewindebohren von Hand (auch maschinell einsetzbar). Die Satz-Zusammenstellung ist beim WM-Set kombinierbar zwischen Vorschneider mit Führungszapfen, Vorschneider, Mittelschneider und Fertigschneider. Das Vorschneiden mit Führungszapfen hilft zum winkelgerechten Anschneiden von Hand. Nur bei Grundlochgewinden muss zusätzlich mit dem Vorschneider auf Gewindetiefe nachgeschnitten werden.







- Straight flutes
- Chamfer form C (2-3 threads) on the finishing tap
- For blind hole and through hole threads

Note:

For thread cutting by hand (suitable also for use on machines). Sets of taps can be composed freely from no. 1 tap with pilot, no. 1 tap, no. 2 tap and finishing tap, in the case of WM sets. Preparatory cutting with a pilot type tap makes a right-angle cut by hand much easier. In blind hole threads, it is necessary to re-cut with a standard no.1 tap to the full thread depth.

1.4 EMUGE Geometriebezeichnungen

1.4 Our EMUGE geometries

 <p>Rekord A Rekord B Rekord D Rekord DF Enorm</p>	<p>Für Stahlwerkstoffe</p> <p>Geometrie mit sehr guter Eigenführung zum lehrenhaltigen Gewindebohren auf allen Maschinen. Sie ist in vielen Gewindesystemen und Abmessungen auf Lager. In Kombination mit Hartstoffschichten können Schnittwerte und Standwerte erhöht werden.</p> <ul style="list-style-type: none"> • Rekord B-STEEL-L Für Stahlwerkstoffe mit niedriger Festigkeit • Rekord B-STEEL-M Für Stahlwerkstoffe mit mittlerer Festigkeit • Rekord B-STEEL-H Für Stahlwerkstoffe mit hoher Festigkeit 	<p>For steel materials</p> <p>Geometry with very good proper guidance for true-to-gauge thread cutting on all machines. Available ex stock in many thread systems and sizes. By combination with hard surface coatings, cutting data and tool life increases can be achieved.</p> <ul style="list-style-type: none"> • Rekord B-STEEL-L For low strength steels • Rekord B-STEEL-M For medium strength steels • Rekord B-STEEL-H For high strength steels
 <p>Rekord B Enorm</p>	<p>Für nichtrostende Stahlwerkstoffe und Stahlwerkstoffe</p> <p>Bei zähen, langspanenden Materialien muss der Span axial in eine Richtung geführt werden, um Spanverklümmungen zu vermeiden. Ein erhöhter Profilveriwinkel reduziert die Reibung und dadurch auch Kaltpressschweißungen.</p>	<p>For stainless steel materials and steel materials</p> <p>With tough and long-chipping materials, the chips must be transported in an axial direction in order to avoid chip jams. An increased profile relief angle reduces friction and with it, the danger of cold welding.</p>
 <p>Rekord A</p>	<p>Für Gusseisen</p> <p>Da Gusseisen ein sehr abrasiver Werkstoff ist, erhalten die Gewindebohrer neben geringerem Spanwinkel immer eine Oberflächenbehandlung zur Standwerterhöhung. Im Allgemeinen genügen für diese kurzspanenden Werkstoffe gerade Spannuten.</p>	<p>For cast iron</p> <p>Since cast iron is a very abrasive material, these taps are always provided with a surface treatment in addition to a low rake angle. In general, straight flutes are sufficient for such short-chipping materials.</p>
 <p>Rekord A</p>	<p>Für Gusseisen mit Vermiculargrafit</p> <p>Neu entwickelte Gusswerkstoffe weisen besondere Gefügestrukturen auf. In Verbindung mit erhöhter Nutenzahl und angepasster Geometrie ermöglichen diese Werkzeuge in diesen abrasiven Werkstoffen als auch in Gusseisen hohe Standwerte.</p>	<p>For cast iron with vermicular graphite</p> <p>Newly developed cast materials often show very special grain structures. In combination with an increased number of flutes and a specially adjusted geometry, these tools permit long tool life even in these highly abrasive materials as well as in normal cast iron.</p>
 <p>Rekord B Enorm</p>	<p>Für Aluminium-Knetlegierungen</p> <p>In langspanendem Aluminium ist es unbedingt notwendig, den Spänen eine axiale Richtung zu geben. Neben großem Spanwinkel haben diese Werkzeuge in der Regel eine Spannuten weniger, damit mehr Späne aufgenommen werden können. Dadurch wird ein Spänenstau in der Nut vermieden.</p>	<p>For aluminium wrought alloys</p> <p>In the machining of long-chipping aluminium, it is absolutely necessary to provide chip transport in an axial direction. In addition to the large rake angle, these tools are made with a reduced number of flutes so that there is even more room for the swarf. This helps to avoid clogging of the flutes.</p>
 <p>Rekord A Rekord D</p>	<p>Für Aluminium-Gusslegierungen</p> <p>Um bei diesem sehr stark verschleißenden Material hohe Standwerte zu erzielen, erhalten die Werkzeuge eine Hartstoffschicht. Innere Kühlschmierstoff-Zuführung wirkt sich besonders vorteilhaft aus.</p>	<p>For aluminium cast alloys</p> <p>In order to achieve a long tool life in this highly abrasive material, all the tools are provided with a hard surface coating. Internal coolant supply also is very helpful.</p>

Product
Finder

Vc

M

MF

UNC
UN-8UNF
UNEFG, Rp
NPSM, NPSFNPT, NPTF
Rc, W

BSW, BSF

Pg

MJ
UNJC, UNJFEG (STI)
SELF-LOCKTr, Tr-F
RdZubehör
Accessories

Tech. Info





- Product Finder
- Vc
- M
- MF
- UNC UN-8
- UNF UNEF
- G, Rp NPSM, NPSF
- NPT, NPTF Rc, W
- BSW, BSF
- Pg
- MJ UNJC, UNJF
- EG (STI) SELF-LOCK
- Tr, Tr-F Rd
- Zubehör Accessories
- Tech. Info







1.4 EMUGE Geometriebezeichnungen

1.4 Our EMUGE geometries

 <p>Rekord A</p>	<p>Für Kupfer-Zink-Legierungen (Messing, kurzspanend)</p> <p>Ein geringer Spanwinkel bringt gute Lehrenhaltigkeit der Gewinde. Gerade Nuten sind in kurzspanendem Messing hervorragend geeignet.</p>	<p>For copper-zinc alloys (brass, short-chipping)</p> <p>A small rake angle ensures that true-to-gauge threads are produced. Straight flutes are perfectly suited for short-chipping brass.</p>
 <p>Rekord A</p>	<p>Für Magnesium-Legierungen</p> <p>Dieser Werkstoff gewinnt zunehmend auch in der Kfz-Industrie an Bedeutung. Durch die besondere Geometrie in Verbindung mit einer Gleit-Deckschicht kann dieses Werkzeug neben Öl- und Emulsionsschmierung auch trocken eingesetzt werden.</p>	<p>For magnesium alloys</p> <p>This workpiece material is gaining more and more importance, especially in the automotive industry. The special geometry, in combination with an anti-friction layer, makes it possible to use this tool for dry machining as well as for oil and emulsion lubrication.</p>
 <p>Rekord A</p>	<p>Für kurzspanende Kunststoffe</p> <p>In Verbindung mit Hartmetall werden durch hohe Freiwinkel in abrasiven Werkstoffen (Duroplaste, faserverstärkte Kunststoffe) hohe Standwerte erreicht. Für Werkstoffe mit einem Faseranteil kleiner 30% steht alternativ ein HSSE-Werkzeug zur Verfügung.</p>	<p>For short-chipping synthetics</p> <p>Large relief angles in combination with carbide material will help to achieve long tool life in abrasive materials (duroplastics, fibre-reinforced synthetics). For workpiece materials with a fibre content of less than 30%, an HSSE tool is available as an alternative.</p>
 <p>Rekord D</p>	<p>Für langspanende Kunststoffe</p> <p>Der Anschnitt dieses Werkzeugs wurde optimiert, um ein sicheres Abscheren der Restspanwurzel im Gewinde sicherzustellen. Eine erhöhte Toleranzlage sowie eine Hartstoffbeschichtung erzeugen in diesen elastischen Werkstoffen lehrenhaltige Gewinde.</p>	<p>For long-chipping synthetics</p> <p>The chamfer of this tool has been optimised in order to ensure a safe shearing off of the chip root in the thread. An elevated tolerance, combined with a hard surface coating, guarantees true-to-gauge threads in these elastic materials.</p>
 <p>Rekord C Rekord D</p>	<p>Für Titan</p> <p>Diese Werkstoffe sind meist sehr fest, langspanend und klemmend. Geringe Spanwinkel und sehr hohe Freiwinkel sind nötig. Häufig muss jedoch das Werkzeug speziell dem Werkstoff und den Einsatzbedingungen angepasst werden.</p>	<p>For titanium</p> <p>These alloys are usually very strong, long-chipping and clamping. Small rake angles and very high relief angles are necessary. Often, it is necessary also to specially adjust the tool to the individual alloy and the specific work conditions.</p>
 <p>Rekord DF</p>	<p>Für Titan-Legierungen</p> <p>Die Titanlegierungen nehmen einen immer höheren Stellenwert in der Industrie ein. Die Geometrie dieses Werkzeuges wurde speziell auf diese Werkstoffe abgestimmt. Hohe Freiwinkelwerte verhindern Kaltpressschweißungen. Eine Anteilung erzeugt kurzes Spanmaterial.</p>	<p>For titanium alloys</p> <p>Titanium alloys are becoming more and more popular in modern industry. The geometry of this tool has been specially adjusted to the machining of these materials. Cold welding is prevented by the extra high relief angle values. A helix correction provides short chips.</p>

1.4 EMUGE Geometriebezeichnungen

1.4 Our EMUGE geometries

 <p>Rekord C Rekord DF</p>	<p>Für Nickel-Legierungen</p> <p>Nickel-Legierungen sind meist sehr zäh, klemmend und hochfest wie z.B. Inconel 718. Negative Spanwinkel, sehr hohe Freiwinkel und eine Hartstoffschicht sind unerlässlich. Pasten- bzw. Ölschmierung ist meist notwendig.</p>	<p>For nickel alloys</p> <p>Nickel alloys are usually very tough, clamping and of high tensile strength, e.g. Inconel 718. Negative rake angles, very high relief angles and a hard surface coating are an unconditional necessity. Lubrication with paste or oil is necessary in most cases.</p>
 <p>Rekord A</p>	<p>Für hochfeste Werkstoffe</p> <p>Relativ große Freiwinkelwerte bringen in Verbindung mit einer Oberflächenbehandlung oder Hartstoffschicht in abrasiven Werkstoffen sehr hohe Standwerte.</p>	<p>For materials of high tensile strength</p> <p>Relatively high relief angle values in combination with a surface treatment or a hard surface coating ensure extra long tool life in abrasive materials.</p>
 <p>Rekord A</p>	<p>Für gehärtete Stähle</p> <p>Diese Geometrie mit speziell angepasster Nutenform sowie Span- und Freiwinkelwerten ermöglicht das Gewindebohren in gehärtetem Stahl. Mit Schneidstoff HSSE-PM für Härten von 44-55 HRC, mit Vollhartmetall für Härten von 55-63 HRC geeignet.</p>	<p>For hardened steels</p> <p>This geometry with its specially adjusted flute profiles and its special rake and relief angles makes thread cutting in hardened steel possible. Made of cutting material HSS-E-PM, these tools are suitable for a material hardness of 44-55 HRC, while solid carbide tools will work in a hardness of 55-63 HRC.</p>
 <p>Rekord A Rekord B Rekord D Enorm</p>	<p>Für CNC-gesteuerte Maschinen</p> <p>Diese sehr schneidfreudige Geometrie mit höherem Span- und Freiwinkel ist für zahlreiche langspanende Werkstoffe geeignet. Sie wurde speziell für CNC-gesteuerte Werkzeugmaschinen konstruiert. Bei synchron gesteuertem Vorschub kommt die Leistungsfähigkeit besonders in Verbindung mit unseren Spannanzgen-Aufnahmen der Typenreihe Softsynchro® zum Tragen.</p>	<p>For CNC-controlled machines</p> <p>This very keen cutting geometry with elevated rake and relief angles is suitable for a multitude of long-chipping materials. It is designed especially for CNC-controlled machine tools. Synchronous feed control, especially in connection with our collet holders of the Softsynchro® series, will bring out the full performance potential of these tools.</p>
 <p>Rekord A Rekord B Enorm</p>	<p>Zum Hochgeschwindigkeitsbohren</p> <p>CNC-Maschinen, besonders in Verbindung mit unserem Speedsynchro®, geben die Voraussetzung, hohe Drehzahlen zu fahren. Die spezielle Geometrie, in Verbindung mit einer Hartstoffschicht, bietet hier die Möglichkeit, auch hohe Schnittgeschwindigkeiten zu realisieren.</p>	<p>For high-speed tapping</p> <p>CNC machines, especially in combination with our Speedsynchro®, make very high speeds possible. The special geometry of these tools, combined with a hard surface coating, offers you the chance to do your machining at the highest speeds your machine can manage.</p>

Product
FinderV_c

M

MF

UNC
UN-8UNF
UNEFG, Rp
NPSM, NPSFNPT, NPTF
Rc, W

BSW, BSF

Pg

MJ
UNJC, UNJFEG (STI)
SELF-LOCKTr, Tr-F
RdZubehör
Accessories

Tech. Info



- Product Finder
- V_c
- M
- MF
- UNC UN-8
- UNF UNEF
- G, Rp NPSM, NPSF
- NPT, NPTF Rc, W
- BSW, BSF
- Pg
- MJ UNJC, UNJF
- EG (STI) SELF-LOCK
- Tr, Tr-F Rd
- Zubehör Accessories
- Tech. Info

1.5 EMUGE Oberflächenbehandlungen und -Beschichtungen

1.5 Our EMUGE surface treatments and coatings

NE2



Oxidieren

In einer Anlage wird den Werkzeugen Wasserdampf zugeführt. Dadurch bildet sich auf der Werkzeugoberfläche eine dunkle Oxidschicht. Diese Oxidschicht bewirkt einen Schutz der Oberfläche. Sie wird ein guter Träger von Schmierstoffen. Kaltschweißungen, wie sie besonders mit kohlenstoffarmen, weichen Stählen auftreten, werden vermieden.

Oxidisation

In a special installation, the tools are exposed to hot steam. This leads to the formation of a dark oxide layer on the tool surface. This oxide layer protects the surface, and acts as a good carrier of lubricants. Cold welding which occurs especially with low-carbon, soft steels, can be prevented in this way.

NT

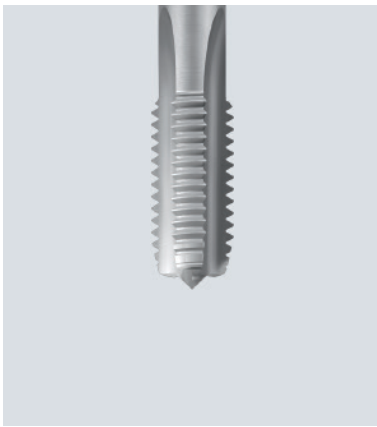

Nitrieren

Durch thermochemische Behandlung wird die Oberfläche im Bereich von ca. 0,03 bis 0,05 mm Eindringtiefe mit Stickstoff angereichert. Da die Oberfläche sehr hart (1000-1250 HV) und spröde wird, eignen sich nitrierte Werkzeuge nur bedingt für Grundlochgewinde bzw. im Umkehrschnitt. In abrasiven Werkstoffen wie Grauguss, Sphäroguss, Aluminiumguss sowie auch Duroplaste wird der Standwert entscheidend erhöht.

Nitriding

In a thermo-chemical treatment, the surface is enriched with nitrogen to a depth of approx. 0.03 to 0.05 mm. Since the surface becomes very hard (1000-1250 HV) and brittle, nitrided tools can be used with certain restrictions only in blind holes and in all work cases which necessitate reversing. In abrasive materials like cast iron, spheroidal cast iron, cast aluminium and duroplastics, tool life can be increased in a decisive manner.

NT2

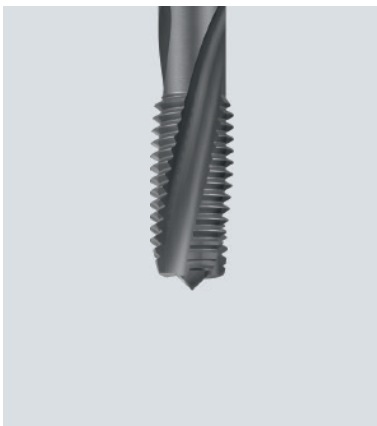

Nitrieren und Oxidieren

Die Oberfläche der Werkzeuge wird zunächst nitriert und anschließend oxidiert (NT + NE2). Dies ergibt eine Kombination aus erhöhter Oberflächenhärte und Schmierstoffträger.

Nitriding and oxidisation

The surface of the tools is first nitrided and then oxidised (NT + NE2). This treatment combines increased surface hardness with an improved lubricant-holding capacity.

TIN

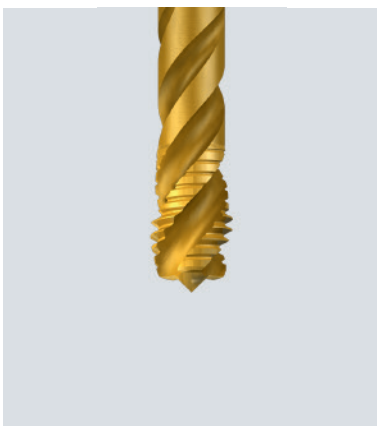

Titannitrid (goldgelb)

Im PVD-Verfahren (500 °C) werden Schichtdicken von 3-7 µm erreicht. Die Schichten zeichnen sich durch hohe Schichthaftung und TIN-typische Eigenschaften gegen Aufschweißungen aus.

TIN-Schichtsysteme mit Zusatzkennnummer (z.B. TIN-60, TIN-70) sind bezüglich Substrat, Werkzeuggeometrie und Anwendung optimiert.

Titanium nitride (gold-yellow)

In a PVD process (500 °C) a coating thickness of 3-7 µm can be realised. The coatings feature a high adhesion strength and TIN-typical properties against cold welding.

TIN coating systems with additional code number (e.g. TIN-60, TIN-70) are optimised with regard to substrate and application.

1.5 EMUGE Oberflächenbehandlungen
und -Beschichtungen

1.5 Our EMUGE surface treatments and coatings

TICN

**Titan-Carbonitrid (blau-grau)**

Im PVD-Verfahren (500 °C) werden Schichtdicken von 2-4 µm erreicht. Die Härte beträgt hier ca. 3000 HV. Die TICN-Schicht bleibt bis ca. 400 °C beständig.

Titanium carbonitride (blue-grey)

In a PVD process (500 °C) a coating thickness of 2-4 µm can be realised. The hardness is approx. 3000 HV. The TICN coating will resist up to approx. 400 °C.

GLT-1

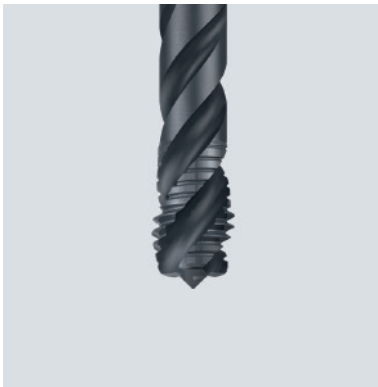
**Hartstoffschicht mit Gleit-Deckschicht (dunkelgrau)**

Im PVD-Verfahren (500 °C) werden Schichtdicken von 2-4 µm erreicht. Die Kombination einer Hartstoffschicht (ca. 3000 HV) mit einer darüberliegenden Gleit-Deckschicht bringt entscheidende Standwertvorteile. Der Spanfluss wird positiv beeinflusst.

Achtung:

Vor dem Nachbeschichten müssen die Werkzeuge entschichtet werden!

Hard surface coating with anti-friction layer (dark-grey)

In a PVD process (500 °C) a coating thickness of 2-4 µm can be realised. The combination of a hard surface coating (approx. 3000 HV) with a superimposed anti-friction layer yields decisive tool life advantages. Also, the chip flow can be very positively influenced.

Please note:

Before re-coating, tools need to be de-coated!

GLT-8

**Diamantähnliche, amorphe Kohlenstoffschicht (schwarz-grau)**

Im PVD-Verfahren werden Schichtdicken von ca. 1-2 µm erreicht. Die Härte beträgt ca. 2500 HV. Diese Monolayerschicht eignet sich hervorragend zur Bearbeitung von Buntmetallen und Aluminium mit niedrigem Si-Gehalt (< 7% Si). Durch den geringen Reibwert wird Werkstoffadhäsion stark vermindert. Die Schicht bleibt bis ca. 350 °C beständig.

Diamond-like, amorphous carbon coating (black-grey)

In a PVD process a coating thickness of 1-2 µm can be realised. The hardness is approx. 2500 HV. This mono-layer coating is an excellent choice for the machining of non-ferrous metals and aluminium with a low silicon content (< 7% Si). Thanks to the low friction, material adhesion is drastically reduced. This coating will remain resistant up to approx. 350 °C.

CRN

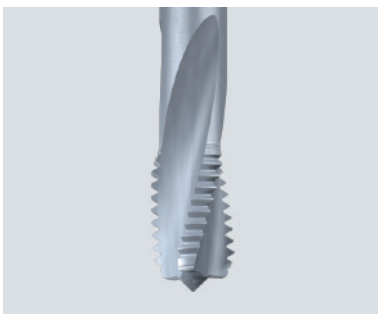
**Chromnitrid (silbergrau)**

Im PVD-Verfahren (500 °C) werden Schichtdicken von bis zu 6 µm erreicht. Bei einer Härte von 1750 HV werden durch hervorragende Gleiteigenschaften in Buntmetallen und Thermoplasten (auch bei hohen Temperaturen) hohe Standwerte erzielt.

Chromium nitride (silver-grey)

In a PVD process (500 °C) coating thicknesses of up to 6 µm can be realised. With a hardness of 1750 HV, the excellent sliding properties will help to achieve long tool life in non-ferrous metals and thermoplastics (even at high temperatures).

CRT

**Chrom-Titannitrid (silbergrau)**

Das CrTi-basierte, eigenspannungsoptimierte Schichtsystem mit Schichtdicken von 5-7 µm eignet sich primär für anspruchsvolle Zerspannungsaufgaben.

Chrome-Titanium nitride (silver-grey)

The CrTi-based layer system is optimised for residual stress and features a layer thickness of 5-7 µm, it is primarily suitable for demanding machining tasks.

Product
FinderV_c

M

MF

UNC
UN-8UNF
UNEFG, Rp
NPSM, NPSFNPT, NPTF
Rc, W

BSW, BSF

Pg

MJ
UNJC, UNJFEG (STI)
SELF-LOCKTr, Tr-F
RdZubehör
Accessories

Tech. Info

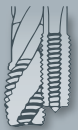

- Product Finder
- Vc
- M
- MZ
- MF
- UNC UN-8
- UNF UNEF
- G, Rp NPSM, NPSF
- NPT, NPTF Rc, W
- BSW, BSF
- Pg
- MJ UNJC, UNJF
- EG (STI) SELF-LOCK
- Tr, Tr-F Rd
- Zubehör Accessories
- Tech. Info

1.6 Sonstige EMUGE-Kurzbezeichnungen

1.6 Other EMUGE abbreviations

AZ



Mit ausgesetzten Zähnen

Durch „ausgesetzte“ Zähne wird Flankenreibung reduziert. Kühlschmierstoff kann ungehindert zwischen die Reibpartner fließen.

With alternating teeth

With “alternating teeth”, flank friction can be reduced. Coolant-lubricant can flow freely between the friction partners.

X



Mit konisch abgesetztem Führungsgewinde

Durch Abschleifen der Zahnspitzen im Führungsgewinde werden Zahnausbrüche auf Grund von Spanverklümmungen vermieden.

With back taper

Tooth chipping due to chip jams can be prevented by grinding off the tooth crests in the guide thread area.

BF

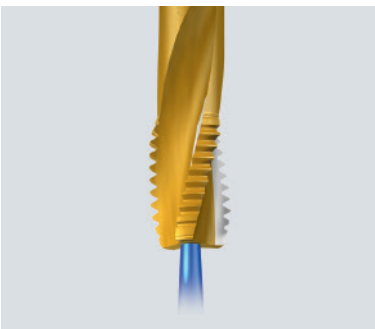

Mit blanker Spanbrust

Durch Abschleifen der Hartstoffschicht an der Spanbrust und spezieller Kantenpräparation, werden in Stahlwerkstoffen kürzere Späne erzeugt. Spanverwicklungen am Werkzeug werden vermieden.

With bright face

“Bright Face” grinding in combination with a special edge preparation ensures that chips will break in steel materials. Short chips will be evacuated without “birdnesting”.

IKZ

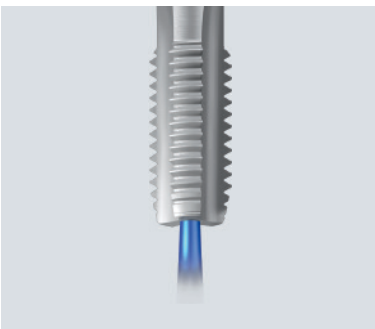

Innere Kühlschmierstoff-Zufuhr, axial (DIN-Bezeichnung: KA)

Axialer Austritt des Kühlschmierstoffes bietet optimale Kühlung im Anschnittbereich. Späne werden aus dem Grundloch gespült.

Internal coolant supply, axial (DIN designation: KA)

The axial exit of coolant-lubricant provides optimum cooling and lubrication in the chamfer area. Chips are evacuated easily from blind holes.

IKZN

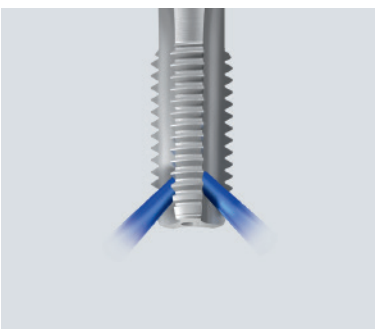

Innere Kühlschmierstoff-Zufuhr, axial mit Austritt in den Nuten (DIN-Bezeichnung: KR)

Radialer Austritt bringt auch beim Durchgangsloch den Kühlschmierstoffprozesssicher in den Anschnittbereich.

Internal coolant supply, axial, with coolant exiting in the flutes (DIN designation: KR)

Radial exit of coolant-lubricant is the safest solution for providing coolant supply in the chamfer area even in through holes.

1.6 Sonstige EMUGE-Kurzbezeichnungen

1.6 Other EMUGE abbreviations

LF**Maschinen-Gewindebohrer mit langen Nuten und langem Schaft**

Je nach Material können durch den längeren Schneidteil und lange Spannuten Gewindetiefen von bis zu $4 \times d_1$ erreicht werden.

Machine taps with long flutes and long shank

Depending on the workpiece material, thread depths of up to $4 \times d_1$ can be achieved with the extended thread part and the long flutes.

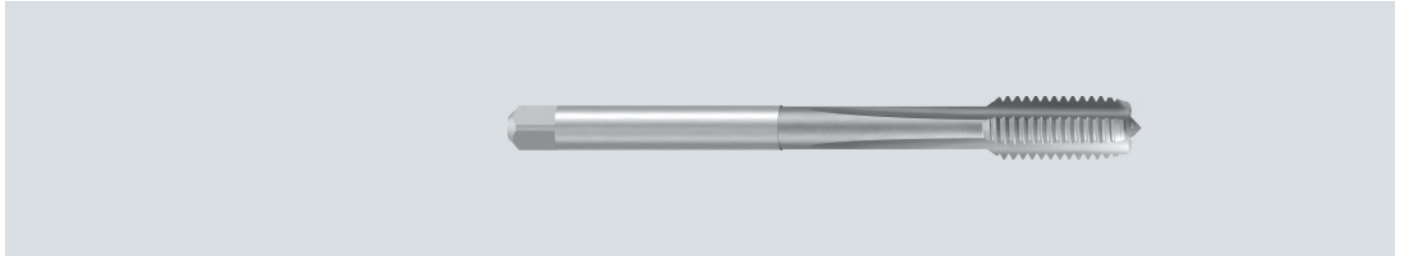
**LS****Maschinen-Gewindebohrer mit extra langem Schaft**

Schwer zugängliche Gewinde können problemlos mit diesen Werkzeugen bearbeitet werden.

Machine taps with extra long shank

Threads with bad access can be easily machined with these tools.

**LH****Linksgewinde**

Linksgewindebohrer sind spiegelbildlich zu Rechtsgewindebohrern.

Left-hand thread

Left-hand taps are mirror-image designs of the right-hand taps.

VHM**Vollhartmetall**

Werkzeuge mit einem Gewindenenddurchmesser $< 12,0$ mm werden aus Vollhartmetall (Gewinde- und Schaftteil) gefertigt.

Solid carbide

Tools with a thread diameter < 12.0 mm are made of solid carbide (thread part and shank).

KHM**Vollhartmetall-Kopf**

Bei Werkzeugen mit einem Gewindenenddurchmesser $\geq 12,0$ mm wird der Gewindeteil aus Vollhartmetall, der Schaftteil aus Werkzeugstahl gefertigt.

Solid carbide head

With tools with a thread diameter ≥ 12.0 mm, the head, or thread part, is made of solid carbide, the shank of tool steel.

„+0,1“**Übermaß**

Werden nach dem Gewindebohren die Innengewinde beschichtet oder das Bauteil warmbehandelt, muss häufig mit „Übermaß“ gebohrt werden.

Oversize

If an internal thread is coated, or the whole component heat-treated after the production of the thread, then it is often necessary to work with “oversize” tools.

Product
Finder

Vc

M

MF

UNC
UN-8UNF
UNEFG, Rp
NPSM, NPSFNPT, NPTF
Rc, W

BSW, BSF

Pg

MJ
UNJC, UNJFEG (STI)
SELF-LOCKTr, Tr-F
RdZubehör
Accessories

Tech. Info



- Product Finder
- V_c
- M
- MF
- UNC UN-8
- UNF UNEF
- G, Rp NPSM, NPSF
- NPT, NPTF Rc, W
- BSW, BSF
- Pg
- MJ UNJC, UNJF
- EG (STI) SELF-LOCK
- Tr, Tr-F Rd
- Zubehör Accessories
- Tech. Info

1.7 Anschnittformen

Anschnittformen und Anschnittlängen für Gewindebohrer nach DIN 2197.

1.7 Chamfer forms

Chamfer forms and chamfer lengths for taps acc. DIN 2197.

Form A

Anschnittlänge 6-8 Gänge

Für gerade Nuten

Chamfer length 6-8 threads

For straight flutes

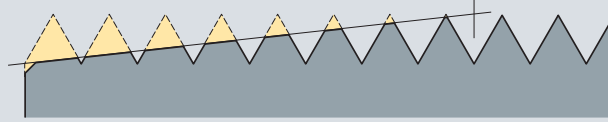

Form B

Anschnittlänge 3,5-5,5 Gänge

Für gerade Nuten mit Schälanschnitt

Chamfer length 3.5-5.5 threads

For straight flutes with spiral point

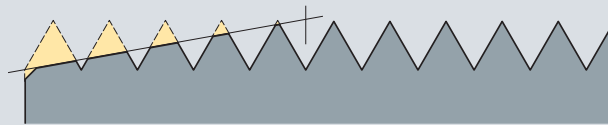

Form C

Anschnittlänge 2-3 Gänge

Für gerade oder gedrahlte Nuten

Chamfer length 2-3 threads

For straight or spiral flutes



Form D

Anschnittlänge 3,5-5 Gänge

Für gerade oder gedrahlte Nuten

Chamfer length 3.5-5 threads

For straight or spiral flutes

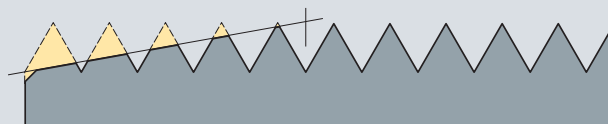

Form E

Anschnittlänge 1,5-2 Gänge

Für gerade oder gedrahlte Nuten

Chamfer length 1.5-2 threads

For straight or spiral flutes



Form F

Anschnittlänge 1-1,5 Gänge

Für gerade oder gedrahlte Nuten

Chamfer length 1-1.5 threads

For straight or spiral flutes



Die Anschnittlänge der EMUGE-Gewindebohrer ist dem jeweiligen Werkstoff im Einzelfall angepasst.

The chamfer length of our EMUGE taps is adjusted to the workpiece material in each individual case.

1.8 Kühl- und Schmierstoffe

Dem Schmiermittel wird im Allgemeinen zu wenig Bedeutung geschenkt. Um vom Werkzeug die volle Leistung zu erhalten, muss der richtige Kühlschmierstoff verwendet werden.

Grundsätzlich unterscheiden wir folgende Arten der Kühlung und Schmierung:

A

Trocken, Druckluft, gekühlte Druckluft

Der reine „Trockenschnitt“ kommt meist nur in Grauguss zum Einsatz. Um Späne zu fördern wird Druckluft – auch gekühlt – eingesetzt.

E

Emulsion

(EMUGE-Gewindeschneidöl Nr. 3+ EMULSION)

Die gebräuchlichste Kühlschmierung auf Bearbeitungszentren.

M

Minimalmengenschmierung (MQL)

Durch die Möglichkeit Luft-Ölgemisch bei modernen Bearbeitungszentren durch die Spindel zu fördern, gewinnt diese Art der Kühlschmierung mehr und mehr an Bedeutung.

O

Gewindeschneidöl

(EMUGE-Gewindeschneidöle Nr. 1+ STEEL, Nr. 2+ CAST IRON, Nr. 4+ NON FERROUS, Nr. 5+ HIGH ALLOY)

Abgestimmt auf die zu bearbeitenden Werkstoffe werden hervorragende Gewindeoberflächen und Standwerte erreicht.

P

Gewindeschneidpaste

(EMUGE-Gewindeschneidpaste Nr. 6+ PASTE)

Zum Gewindeformen hervorragend geeignet. Besonders vorteilhaft bei waagrechtter Bearbeitung, großen Abmessungen und Durchgangslochgewinden. Kann nur für Pinselschmierung verwendet werden.

1.8 Cooling and lubrication agents

Lubricants are often, if not generally, given too little consideration. If you want to get the best performance out of your tool you have to take care to use the best coolant-lubricant available.

In general, we distinguish the following types of cooling and lubrication:

Dry machining, pressurised air, cold pressurised air

“Real” dry machining is mostly used only in cast iron. Pressurised air, sometimes cooled, is used in some cases for chip removal.

Emulsion

(EMUGE thread cutting oil no. 3+ EMULSION)

The most common type of coolant-lubricant on machining centres.

Minimum-quantity lubrication (MQL)

Due to the more and more common option of supplying aerosol through the spindle on modern machining centres, this type of cooling and lubrication is gaining more and more popularity.

Thread cutting oil

(EMUGE thread cutting oils no.1+ STEEL, no. 2+ CAST IRON, no. 4+ NON FERROUS, no. 5+ HIGH ALLOY)

With these oils which are perfectly adjusted to specific materials, excellent thread surfaces and tool life can be achieved.

Thread cutting paste

(EMUGE thread cutting paste no. 6+ PASTE)

Perfectly suitable for the cold forming of threads. Especially useful in horizontal machining, with large thread sizes and through hole threads. To be used only for brush lubrication.

Product
FinderV_c

M

MF

UNC
UN-8UNF
UNEFG, Rp
NPSM, NPSFNPT, NPTF
Rc, W

BSW, BSF

Pg

MJ
UNJC, UNJFEG (STI)
SELF-LOCKTr, Tr-F
RdZubehör
Accessories

Tech. Info

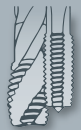

- Product Finder
- V_c
- M
- MF
- UNC UN-8
- UNF UNEF
- G, Rp NPSM, NPSF
- NPT, NPTF Rc, W
- BSW, BSF
- Pg
- MJ UNJC, UNJF
- EG (STI) SELF-LOCK
- Tr, Tr-F Rd
- Zubehör Accessories
- Tech. Info

1.9 Toleranzfelder des Flankendurchmessers beim Metrischen Gewinde (schematische Darstellung)

1.9 Tolerance zones of the pitch diameter on the Metric thread (graphic representation)

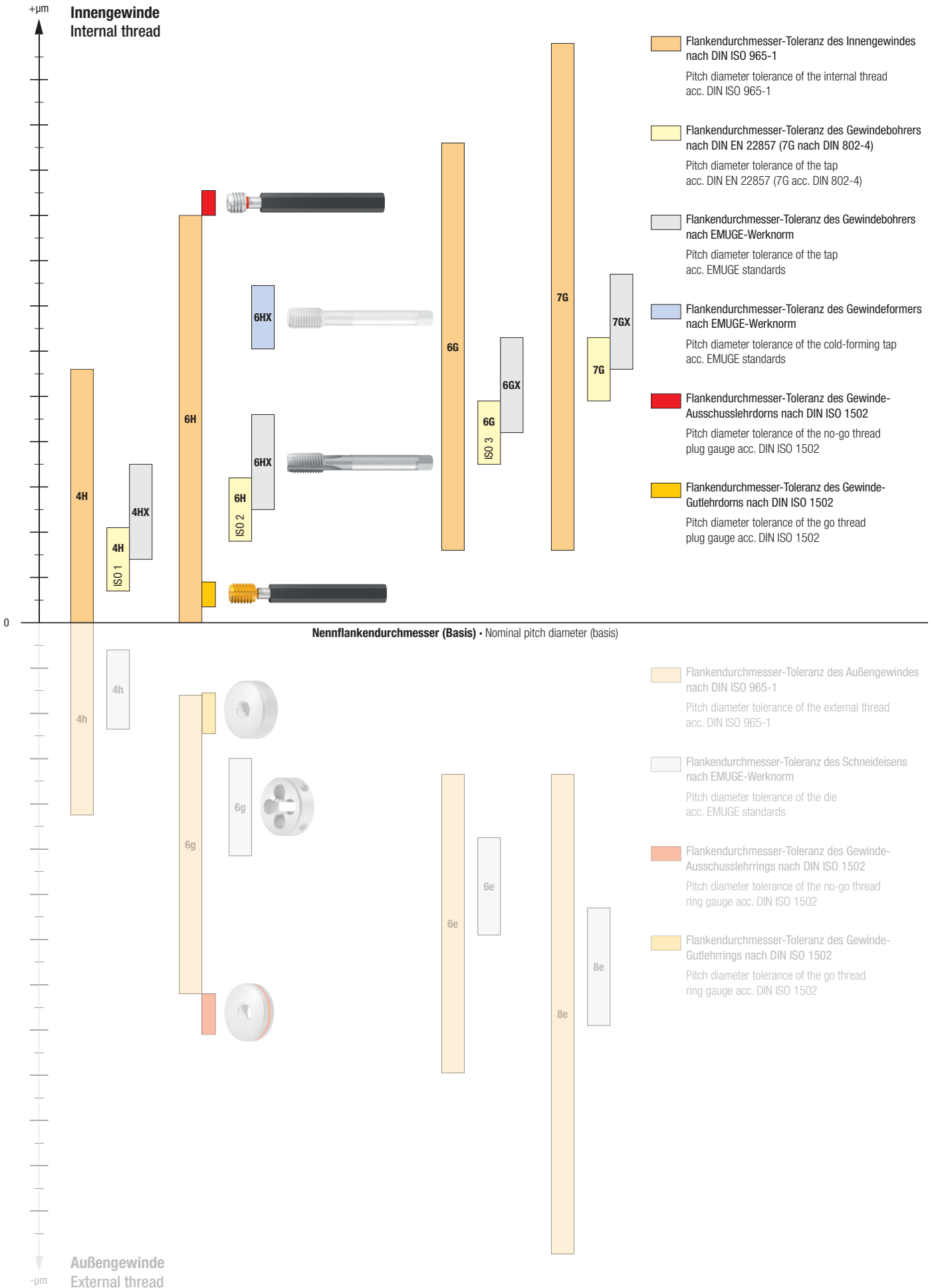

1.10 Toleranzfelder des Flankendurchmessers beim Unified-Gewinde (schematische Darstellung)

1.10 Tolerance zones of the pitch diameter on the Unified thread (graphic representation)

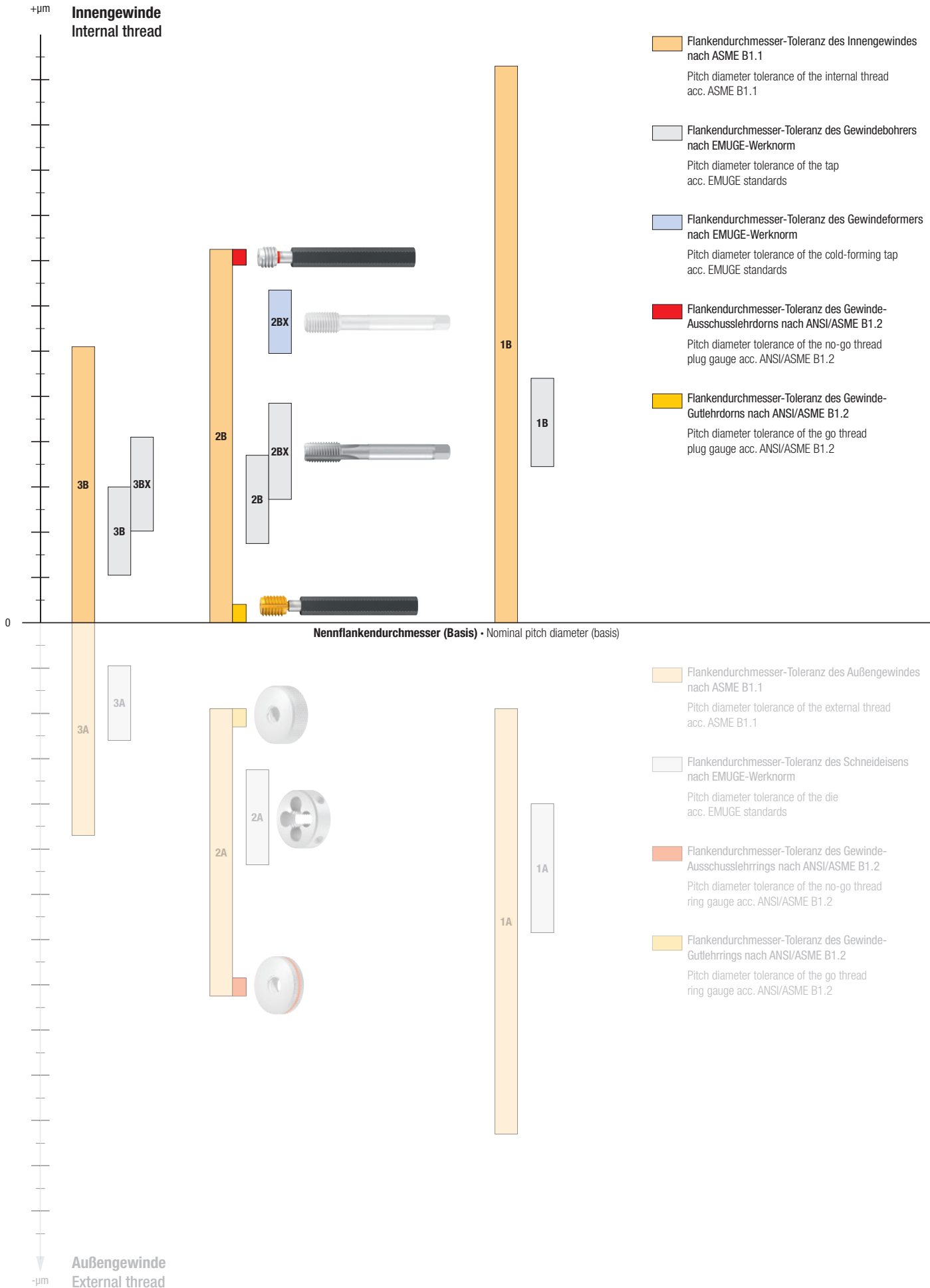

- Product Finder
- Vc
 - M
 - MF
 - UNC UN-8
 - UNF UNEF
 - G, Rp NPSM, NPSF
 - NPT, NPTF Rc, W
 - BSW, BSF
 - Pg
 - MJ UNJC, UNJF
 - EG (ST) SELF-LOCK
 - Tr, Tr-F Rd
 - Zubehör Accessories

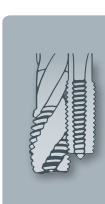

- Product Finder
- v_c**
- M
- MF
- UNC UN-8
- UNF UNEF
- G, Rp NPSM, NPSF
- NPT, NPTF Rc, W
- BSW, BSF
- Pg
- MJ UNJC, UNJF
- EG (STI) SELF-LOCK
- Tr, Tr-F Rd
- Zubehör Accessories
- Tech. Info**

1.11 Berechnung der Schnittdaten

1.11 Calculation of cutting data

	$n = \frac{v_c \cdot 1000}{d_1 \cdot \pi} \quad [\text{min}^{-1}]$	<p>Drehzahl n in min⁻¹ d₁ = Gewindenenddurchmesser in mm v_c = Schnittgeschwindigkeit in m/min</p>	<p>Speed n in min⁻¹ (rpm) d₁ = Major diameter of thread in mm v_c = Cutting speed in m/min</p>
	$v_c = \frac{d_1 \cdot \pi \cdot n}{1000} \quad [\text{m/min}]$	<p>Schnittgeschwindigkeit v_c in m/min d₁ = Gewindenenddurchmesser in mm n = Drehzahl in min⁻¹</p>	<p>Cutting speed v_c in m/min d₁ = Major diameter of thread in mm n = Speed in min⁻¹ (rpm)</p>
	$M_c = \frac{k_c \cdot P^2 \cdot d_1}{8000} \quad [\text{Nm}]$	<p>Schnittmoment am Gewindebohrer M_c in Nm (für Spitzgewinde M, MF, UNC, UNF, usw.) k_c = Spezifische Schnittkraft in N/mm² P = Gewindesteigung in mm d₁ = Gewindenenddurchmesser in mm</p>	<p>Cutting torque on the tap M_c in Nm (for tapered threads M, MF, UNC, UNF etc) k_c = Specific cutting force in N/mm² P = Thread pitch in mm d₁ = Major diameter of thread in mm</p>
	$P_c = \frac{M_c \cdot n}{9550 \cdot \eta} \quad [\text{kW}]$	<p>Maschinenantriebsleistung P_c in kW M_c = Schnittmoment am Gewindebohrer in Nm n = Drehzahl in min⁻¹ η = Wirkungsgrad der Maschine</p>	<p>Machine drive power P_c in kW M_c = Cutting torque on the tap in Nm n = Speed in min⁻¹ (rpm) η = Efficiency of the machine</p>



Beispiel für Drehmoment- und Leistungsberechnung

Gewinde: M64x4-6H
 Material: St52 (680 N/mm²)
 Schnittgeschwindigkeit v_c: 6 m/min
 Drehzahl n: 30 min⁻¹
 Wirkungsgrad der Maschine η: 0,6

Sample calculation of torque and performance

Thread: M64x4-6H
 Material: St52 (680 N/mm²)
 Cutting speed v_c: 6 m/min
 Speed n: 30 rpm
 Efficiency of the machine η: 0.6

$$M_c = \frac{2500 \cdot 4^2 \cdot 64}{8000} \quad [\text{Nm}]$$

Schnittmoment am Gewindebohrer M_c in Nm

(für Spitzgewinde M, MF, UNC, UNF, usw.)
 M_c = 320 Nm

Cutting torque on the tap M_c in Nm

(for tapered threads M, MF, UNC, UNF etc)
 M_c = 320 Nm

$$P_c = \frac{320 \cdot 30}{9550 \cdot 0,6} \quad [\text{kW}]$$

Maschinenantriebsleistung P_c in kW

(Gewindebohrer im Neuzustand)
 P_c = 1,67 kW

Machine drive power P_c in kW

(tap in new condition)
 P_c = 1.67 kW

Durch Verschleiß am Gewindebohrer, oder auch kurzzeitige Spanverklümmungen, sollte der **dreifache Wert** als Berechnungsgrundlage verwendet werden. Einfluss auf Schnittmoment und Leistung haben neben Spanablauf auch Geometrie und Beschichtung am Werkzeug, sowie die Schmierung.

Due to wear of the tap and temporarily jammed chips, **three times** the value should be used as calculation basis. Influential factors besides chip evacuation affecting cutting torque and performance are geometry and coating of the tool as well as the lubrication.

Somit sollte bei diesem Beispiel die Antriebsleistung 3 x 1,67 kW = **5 kW** betragen.

Therefore the drive power in our example should be 3 x 1,67 kW = **5kW**.

1.11 Berechnung der Schnittdaten

1.11 Calculation of cutting data

Spezifische Schnittkraft k_c in N/mm²Specific cutting force k_c in N/mm²

Einsatzgebiete – Material Applications – material			Spezifische Schnittkraft k_c in N/mm ² Specific cutting force k_c in N/mm ²		
	Stahlwerkstoffe Steel materials				
P	1.1 Kaltfließpressstähle, Baustähle, Automatenstähle, u.a.	Cold-extrusion steels, Construction steels, Free-cutting steels, etc.	≤ 600 N/mm ²	2300	
	2.1 Baustähle, Einsatzstähle, Stahlguss, u.a.	Construction steels, Cementation steels, Steel castings, etc.	≤ 800 N/mm ²	2500	
	3.1 Einsatzstähle, Vergütungsstähle, Kaltarbeitsstähle, u.a.	Cementation steels, Heat-treatable steels, Cold work steels, etc.	≤ 1000 N/mm ²	2600	
	4.1 Vergütungsstähle, Kaltarbeitsstähle, Nitrierstähle, u.a.	Heat-treatable steels, Cold work steels, Nitriding steels, etc.	≤ 1200 N/mm ²	3000	
	5.1 Hochlegierte Stähle, Kaltarbeitsstähle, Warmarbeitsstähle, u.a.	High-alloyed steels, Cold work steels, Hot work steels, etc.	≤ 1400 N/mm ²	3600	
M	Nichtrostende Stahlwerkstoffe Stainless steel materials				
	1.1 Ferritisch, martensitisch	Ferritic, martensitic	≤ 950 N/mm ²	3200	
	2.1 Austenitisch	Austenitic	≤ 950 N/mm ²	3200	
	3.1 Austenitisch-ferritisch (Duplex)	Austenitic-ferritic (Duplex)	≤ 1100 N/mm ²	3200	
4.1 Austenitisch-ferritisch hitzebeständig (Super Duplex)	Austenitic-ferritic heat-resistant (Super Duplex)	≤ 1250 N/mm ²	4000		
K	Gusswerkstoffe Cast materials				
	1.1 Gusseisen mit Lamellengrafit (GJL)	Cast iron with lamellar graphite (GJL)	100-250 N/mm ²	1600	
	1.2		250-450 N/mm ²	1600	
	2.1 Gusseisen mit Kugelgrafit (GJS)	Cast iron with nodular graphite (GJS)	350-500 N/mm ²	2400	
	2.2		500-900 N/mm ²	2400	
	3.1 Gusseisen mit Vermiculargrafit (GJV)	Cast iron with vermicular graphite (GJV)	300-400 N/mm ²	2500	
	3.2		400-500 N/mm ²	2500	
4.1	Temperguss (GTMW, GTMB)	Malleable cast iron (GTMW, GTMB)	250-500 N/mm ²	2700	
4.2		500-800 N/mm ²	2700		
N	Nichteisenwerkstoffe Non ferrous materials				
	Aluminium-Legierungen Aluminium alloys				
	1.1		≤ 200 N/mm ²	680	
	1.2	Aluminium-Knetlegierungen	Aluminium wrought alloys	≤ 350 N/mm ²	680
	1.3		≤ 550 N/mm ²	680	
	1.4		Si ≤ 7%	680	
	1.5	Aluminium-Gusslegierungen	Aluminium cast alloys	7% < Si ≤ 12%	680
	1.6		12% < Si ≤ 17%	680	
	Kupfer-Legierungen Copper alloys				
	2.1	Reinkupfer, niedriglegiertes Kupfer	Pure copper, low-alloyed copper	≤ 400 N/mm ²	1100
	2.2	Kupfer-Zink-Legierungen (Messing, langspanend)	Copper-zinc alloys (brass, long-chipping)	≤ 550 N/mm ²	720
	2.3	Kupfer-Zink-Legierungen (Messing, kurzspanend)	Copper-zinc alloys (brass, short-chipping)	≤ 550 N/mm ²	720
	2.4	Kupfer-Aluminium-Legierungen (Alubronze, langspanend)	Copper-aluminium alloys (alu bronze, long-chipping)	≤ 800 N/mm ²	1900
	2.5	Kupfer-Zinn-Legierungen (Zinnbronze, langspanend)	Copper-tin alloys (tin bronze, long-chipping)	≤ 700 N/mm ²	1900
	2.6	Kupfer-Zinn-Legierungen (Zinnbronze, kurzspanend)	Copper-tin alloys (tin bronze, short-chipping)	≤ 400 N/mm ²	1900
	2.7			≤ 600 N/mm ²	1400
	2.8	Kupfer-Sonderlegierungen	Special copper alloys	≤ 1400 N/mm ²	1400
	Magnesium-Legierungen Magnesium alloys				
	3.1	Magnesium-Knetlegierungen	Magnesium wrought alloys	≤ 500 N/mm ²	750
	3.2	Magnesium-Gusslegierungen	Magnesium cast alloys	≤ 500 N/mm ²	750
Kunststoffe Synthetics					
4.1	Duroplaste (kurzspanend)	Duroplastics (short-chipping)		500	
4.2	Thermoplaste (langspanend)	Thermoplastics (long-chipping)		500	
4.3	Faserverstärkte Kunststoffe (Faseranteil ≤ 30%)	Fibre-reinforced synthetics (fibre content ≤ 30%)		500	
4.4	Faserverstärkte Kunststoffe (Faseranteil > 30%)	Fibre-reinforced synthetics (fibre content > 30%)		500	
Besondere Werkstoffe Special materials					
5.1	Grafit	Graphite		480	
5.2	Wolfram-Kupfer-Legierungen	Tungsten-copper alloys		480	
5.3	Verbundwerkstoffe	Composite materials		480	
S	Spezialwerkstoffe Special materials				
	Titan-Legierungen Titanium alloys				
	1.1	Reintitan	Pure titanium	≤ 450 N/mm ²	4000
	1.2			≤ 900 N/mm ²	4000
	1.3	Titan-Legierungen	Titanium alloys	≤ 1250 N/mm ²	4000
	Nickel-, Kobalt- und Eisen-Legierungen Nickel alloys, cobalt alloys and iron alloys				
	2.1	Reinnickel	Pure nickel	≤ 600 N/mm ²	4000
	2.2			≤ 1000 N/mm ²	4000
	2.3	Nickel-Basis-Legierungen	Nickel-base alloys	≤ 1600 N/mm ²	4000
	2.4			≤ 1000 N/mm ²	4000
2.5	Kobalt-Basis-Legierungen	Cobalt-base alloys	≤ 1600 N/mm ²	4000	
2.6	Eisen-Basis-Legierungen	Iron-base alloys	≤ 1500 N/mm ²	4000	
H	Harte Werkstoffe Hard materials				
	1.1		44 - 50 HRC	4100	
	1.2		50 - 55 HRC	4700	
	1.3	Hochfeste Stähle, gehärtete Stähle, Hartguss	High strength steels, hardened steels, hard castings	55 - 60 HRC	5000
	1.4		60 - 63 HRC	5200	
1.5		63 - 66 HRC	5200		

Product
FinderV_c

M

MF

UNC
UN-8UNF
UNEFG, Rp
NPSM, NPSFNPT, NPTF
Rc, W

BSW, BSF

Pg

MJ
UNJC, UNJFEG (ST)
SELF-LOCKTr, Tr-F
RdZubehör
Accessories

Tech. Info



- Product Finder
- V_c
- M
- MF
- UNC UN-8
- UNF UNEF
- G, Rp NPSM, NPSF
- NPT, NPTF Rc, W
- BSW, BSF
- Pg
- MJ UNJC, UNJF
- EG (STI) SELF-LOCK
- Tr, Tr-F Rd
- Zubehör Accessories
- Tech. Info

1.12 Schematischer Drehmomentverlauf beim Gewindebohren

1.12 Schematic of torque curve during a thread cutting process

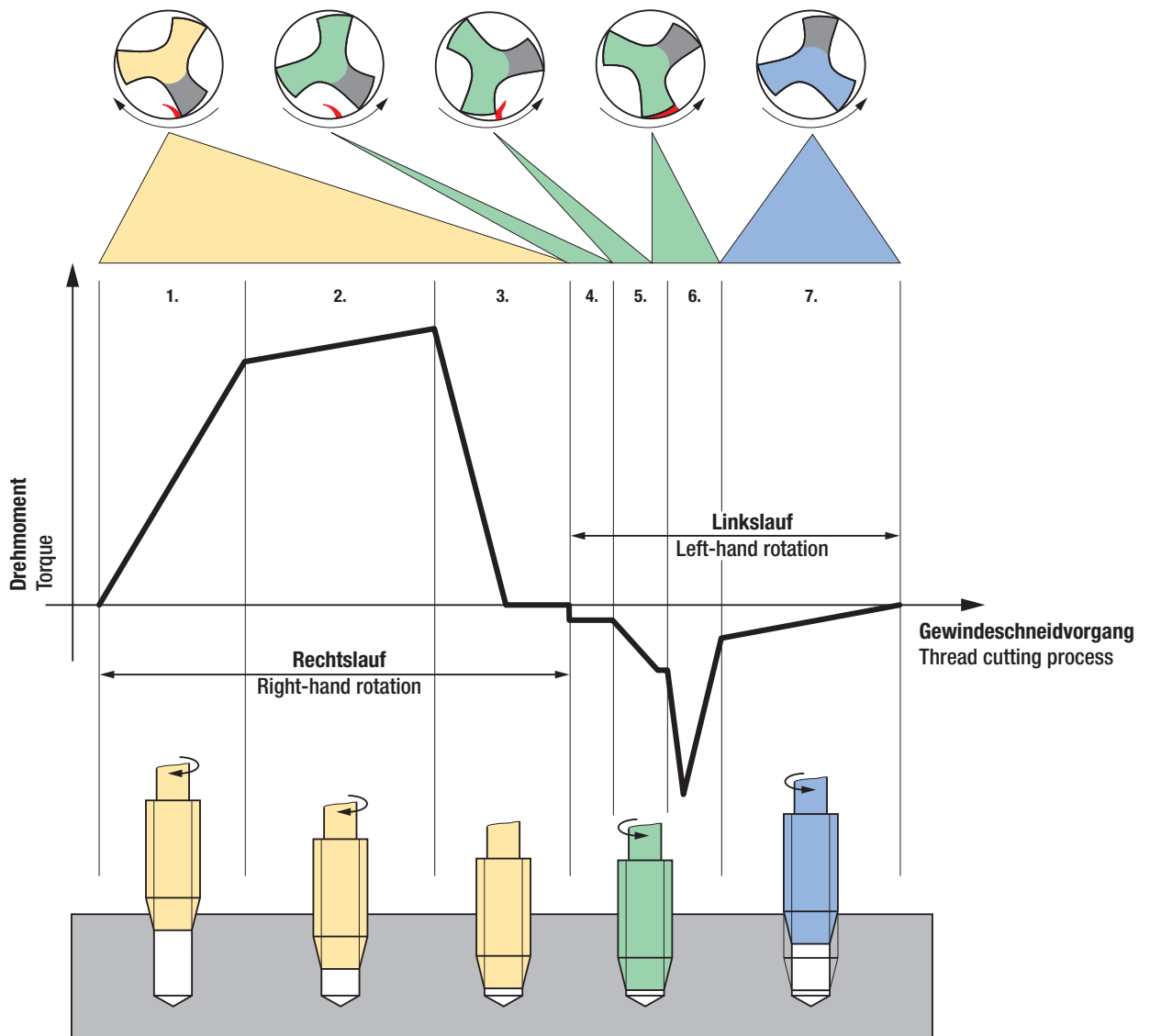

1. Anschneiden des Gewindebohrers bis zum Eingriff aller Anschnittzähne

2. Schnittmomente des jetzt mit allen Anschnittzähnen schneidenden Gewindebohrers

3. Abbremsen der Maschinenspindel bis zum Stillstand

4. Beginnender Rücklauf der Spindel bis zum Kontakt des Zahnstegrückens mit dem in der Bohrung stehenden Span der Folgeschneide

5. Abscheren des Spans

6. Zurückquetschen der nach der Spanabscherung stehengebliebenen Spanwurzel (Größe abhängig vom Anschnitt-Freiwinkel des Gewindebohrers sowie des Rückenschnittwinkels)

7. Gleitreibung zwischen Gewindebohrer und Werkstück

1. Beginning of cut to full contact of all chamfer teeth

2. Cutting torque of the tap which is now cutting with all its chamfer teeth

3. Braking the machine spindle to a stop

4. Beginning reversal of the spindle to contact of the tooth back with the chip root left standing by the next cutting tap tooth

5. Shearing off the chip root

6. Squashing back the chip root remains left after the shearing off of the chip root (size depending on the chamfer relief angle of the tap and on the rear cutting angle of the tap tooth)

7. Sliding friction between tap and workpiece

1.13 Technischer Fragebogen: Gewindebohren

Firma:
 Ansprechpartner:
 Telefon:
 Fax:
 E-Mail:

Abmessung:
 Ausführung:
 Artikel-Nr.:
 Projekt:

Werkstückbezeichnung:

Kernlochdurchmesser:

Kernlochform (bitte Maße eintragen):

- gebohrt geräumt gestanzt
 gegossen gezogen

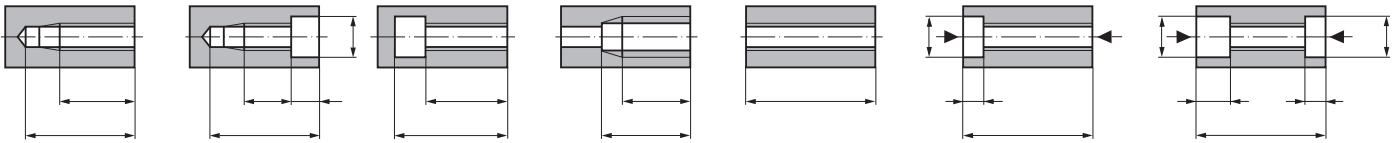

Maschine:

Hersteller:
 Typ:
 Antriebsleistung: kW

- horizontal Werkzeug rotierend
 vertikal Werkzeug stehend

Schnittdaten:

Drehzahl n: min⁻¹
 Schnittgeschwindigkeit v_c: m/min

Vorschub:

- Andruckkurve Sonstige:
 Hydraulik
 Leitpatrone
 NC-gesteuert
 Synchronspindel
 Zahnräder

Werkzeugaufnahme:

- starr (Spannzange)
 Gewindeschneidapparat } Hersteller:
 Gewindeschneidfutter } Typ:
 mit Überlastkupplung
 mit Längenausgleich
 mit achsparalleler Pendelung
 mit innerer Kühlschmierstoff-Zufuhr Druck: bar

Spindelaufnahme:

MK / SK / HSK / TR / andere:
 DIN / ANSI / JIS / andere:

Werkstückwerkstoff:

Bezeichnung:
 Behandlungszustand:
 Festigkeit: N/mm²
 Härte: Dehnung: %
 kurzspanend langspanend

Kühlung:

- Öl Emulsion % Trocken
 Umlauf Pinsel Nebel Sonstige:

Werkzeug-Empfehlung:

Ausführung:
 Artikel-Nr.:
 Schaftdurchmesser: DIN:
 Besonderheit:
 Bisher verwendete Werkzeuge (Hersteller):
 Standwert: (Anzahl der Gewinde)

Aufgenommen von:

Datum / Unterschrift:

Product Finder

v_c

M

MF

UNC UN-8

UNF UNEF

G, Rp NPSM, NPSF

NPT, NPTF Rc, W

BSW, BSF

Pg

MJ UNJC, UNJF

EG (ST) SELF-LOCK

Tr, Tr-F Rd

Zubehör Accessories

Tech. Info



- Product Finder
- V_c
- M
- MF
- UNC UN-8
- UNF UNEF
- G, Rp NPSM, NPSF
- NPT, NPTF Rc, W
- BSW, BSF
- Pg
- MJ UNJC, UNJF
- EG (STI) SELF-LOCK
- Tr, Tr-F Rd

1.13 Technical questionnaire: Tapping of threads

Company:
 Contact:
 Phone:
 Fax:
 E-mail:

Size:
 Design:
 Article no.:
 Project:

Workpiece description:

Thread hole diameter:

- drilled broached stamped
 cast drawn

Hole type (please enter dimensional specifications):

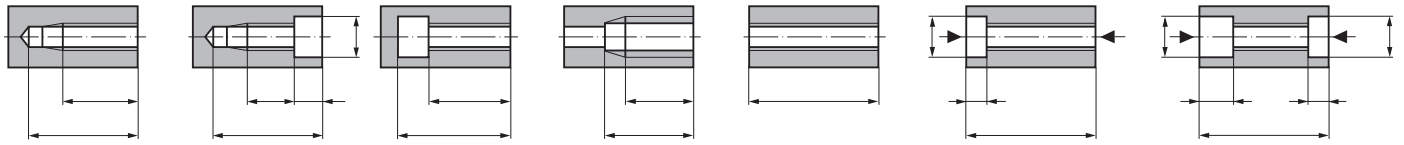

Machine:

Manufacturer:
 Type:
 Power: kW

- horizontal rotating tool
 vertical standing tool

Cutting data:

Speed n: rpm
 Cutting speed v_c: m/min

Feed:

- Pressure cam Others:
 Hydraulics
 Lead screw
 NC-controlled
 Synchronous spindle
 Gear wheels

Tool holder:

- rigid (collet)
 Tapping attachment } Manufacturer:
 Tap holder } Type:
 with overload clutch
 with length compensation
 with axial parallel floating
 with internal coolant supply Pressure: bar

Spindle adaptation:

MT / ISO taper / HSK / TR / others:
 DIN / ANSI / JIS / others:

Workpiece material:

Description:
 Condition during work:
 Tensile strength: N/mm²
 Hardness: Elongation: %
 short-chipping long-chipping

Cooling/lubrication:

- Oil Emulsion % Dry
 Circulation Brush Mist Others:

Tool recommendation:

Design:
 Article no.:
 Shank diameter: DIN:
 Special features:
 Tools used until now (manufacturer):
 Tool life: (no. of threads)

Filled in by:

Date / signature:



Gewindeformer Cold-Forming Taps

Seite · Page

Übersicht	Contents	269 - 271
Wegweiser und Schnittwerte	Product finder and cutting data	272 - 277
Produktseiten	Product pages	278 - 304
Technische Informationen	Technical information	305 - 324

Cut&Form – Innengewindefertigung durch Kombination von Spanen und Umformen

Das Innengewinde-Fertigungssystem Cut&Form ist eine Kombination aus spanenden und umformenden Verfahren, welche jeweils einen bestimmten Teil des Gewindeprofils erzeugen.

Cut&Form – Production of internal threads by a combination of machining and cold forming

The internal thread production system Cut&Form is a combination of machining and cold-forming processes which each produce a specific part of the thread profile.



- Verfestigung des Gewindes und Erhöhung der Dauerfestigkeit
- Gewindeformen von großen Gewindesteigungen
- Gewindeformen von schlecht fließenden Werkstoffen
- Erzeugung eines eng tolerierten Innengewindekerndurchmessers ohne „Kralle“
- Glättung der Gewindeoberfläche

- Strengthened threads and increased long-term resistance
- Cold forming of large threads with coarse pitch
- Cold forming of threads in difficult materials
- Production of a narrow-tolerance minor diameter without space pocket
- Extra smooth thread surfaces

Gewindeformer mit verstärktem Schaft
Cold-forming taps with reinforced shank



Drück 1
InnoForm 1

Gewindeformer mit durchfallendem Schaft
Cold-forming taps with reduced shank



Drück 2
InnoForm 2

Gewindeformer mit langem Schaft
Cold-forming taps with long shank



InnoForm 2-LF3
InnoForm 2-LF4

Gewindeformer mit extra-langem Schaft
Cold-forming taps with extra long shank



InnoForm 1-LS
InnoForm 2-LS

Seite · Page

278 - 285	287 - 290	292 - 293	286, 291	M
294 - 295	296 - 298			MF
299	300			UNC
301	302			UNF
	303			G (BSP)
304				LK-M

Seite · Page



Kühlschmierstoffe
Coolant-lubricants

238 - 239



Spezial-Schaftverlängerungen
Special shank extensions

240 - 242



- Product Finder
- Vc
- M
- MF
- UNC
- UNF
- G
- SELF-LOCK
- Tech. Info

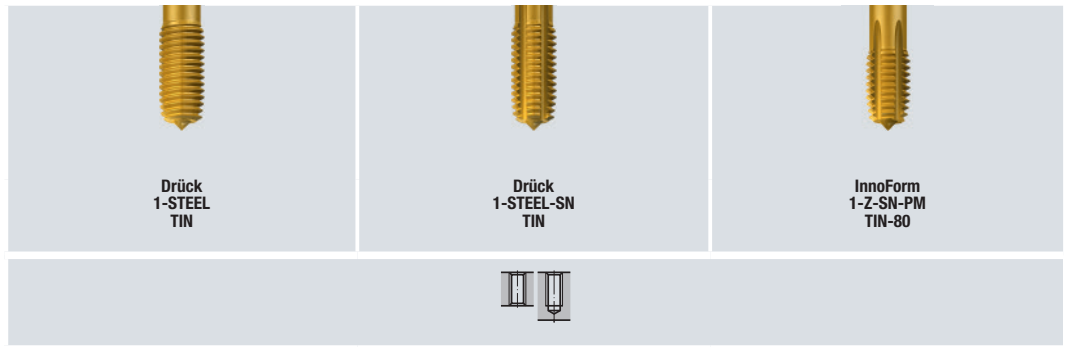

Seite · Page

M	6GX	279	279	283
----------	------------	-----	-----	-----



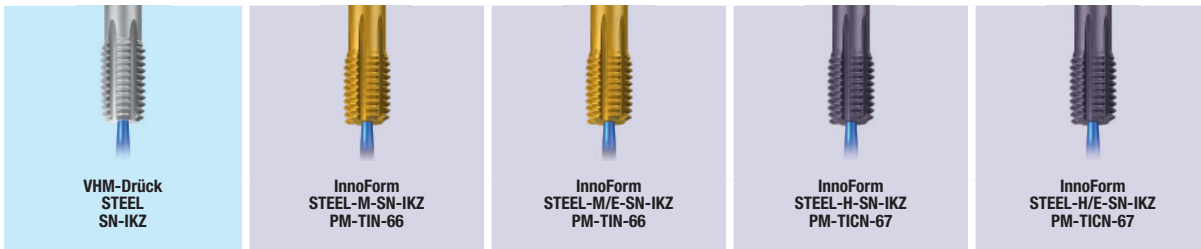

Product Finder

Vc

M

MF

UNC

UNF

G

SELF-LOCK

Tech. Info

Seite · Page

279	279, 287	279, 287	279, 288	280, 288
	296	296	297	297

M
MF
UNC
UNF
G (BSP)



Seite · Page

280	281	281	281	282

M
MF
UNC
UNF
G (BSP)

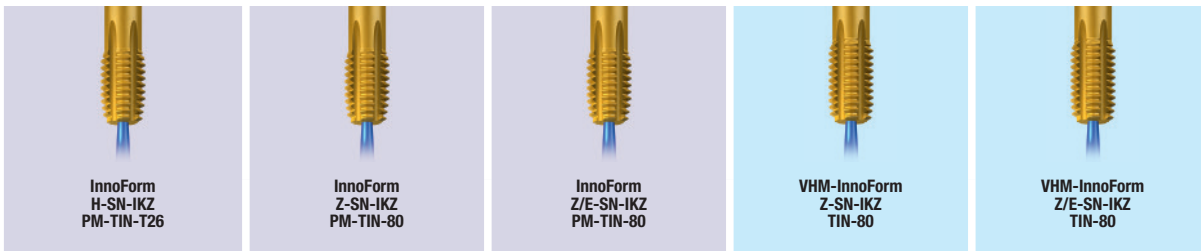

Seite · Page

283, 289, 292, 293	283, 286, 289, 291	283, 289	284	284
297	295, 297			
	299, 300			
	301, 302			
	303			

M
MF
UNC
UNF
G (BSP)

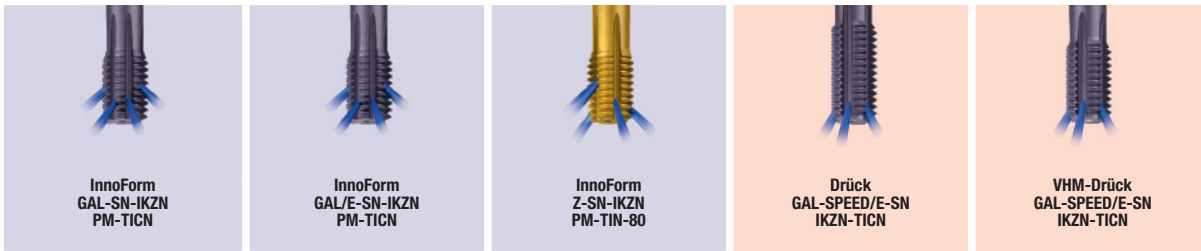

Seite · Page

281	282	283, 289, 292, 293	285, 290	285, 290
			295, 298	295, 298

M
MF
UNC
UNF
G (BSP)

- Product Finder
- V_c
- M
- MF
- UNC
- UNF
- G
- SELF-LOCK
- Tech. Info

Wegweiser und Schnittwerte

Bitte beachten:

Die in den jeweiligen Spalten angegebenen Umfangsgeschwindigkeiten (v_c in m/min) sind Richtwerte, welche je nach Einsatzbedingungen (Material, Schmierung, Maschine, usw.) angepasst werden müssen.

Die Eignung ist folgendermaßen gekennzeichnet:

- Gewindeformer sehr gut geeignet
- Gewindeformer gut geeignet

 = DIN-Form / Gänge (Anformkegellänge)

Internationaler Werkstoffvergleich siehe Seite 838 - 851.

Product finder and cutting data

Please note:

The circumferential speeds (v_c in m/min) listed in the respective columns are standard values which have to be adjusted to individual work conditions (material, lubrication, machine etc.).

The suitability is marked as follows:

- Cold-forming tap is very suitable
- Cold-forming tap is suitable

 = DIN form / threads (lead taper length)

International comparison of materials, see page 838 - 851.

Einsatzgebiete – Material Applications – material		Material-Beispiele Material examples	Material-Nummern Material numbers
P	Stahlwerkstoffe Kaltfließpressstähle, Baustähle, Automatenstähle, u.a.	Steel materials Cold-extrusion steels, Construction steels, Free-cutting steels, etc.	Cq15 1.1132 S235JR (St37-2) 1.0037 10SPb20 1.0722
	2.1 Baustähle, Einsatzstähle, Stahlguss, u.a.	Construction steels, Cementation steels, Steel castings, etc.	E360 (St70-2) 1.0070 16MnCr5 1.7131 GS-25CrMo4 1.7218
	3.1 Einsatzstähle, Vergütungsstähle, Kaltarbeitsstähle, u.a.	Cementation steels, Heat-treatable steels, Cold work steels, etc.	20MoCr3 1.7320 42CrMo4 1.7225 102Cr6 1.2067 50CrMo4 1.7228
	4.1 Vergütungsstähle, Kaltarbeitsstähle, Nitrierstähle, u.a.	Heat-treatable steels, Cold work steels, Nitriding steels, etc.	X45NiCrMo4 1.2767 31CrMo12 1.8515 X38CrMoV5-3 1.2367
	5.1 Hochlegierte Stähle, Kaltarbeitsstähle, Warmarbeitsstähle, u.a.	High-alloyed steels, Cold work steels, Hot work steels, etc.	X100CrMoV8-1-1 1.2990 X40CrMoV5-1 1.2344
M	Nichtrostende Stahlwerkstoffe 1.1 Ferritisch, martensitisch	Stainless steel materials Ferritic, martensitic	X2CrTi12 1.4512
	2.1 Austenitisch	Austenitic	X6CrNiMoTi17-12-2 1.4571
	3.1 Austenitisch-ferritisch (Duplex)	Austenitic-ferritic (Duplex)	X2CrNiMoN22-5-3 1.4462
	4.1 Austenitisch-ferritisch hitzebeständig (Super Duplex)	Austenitic-ferritic heat-resistant (Super Duplex)	X2CrNiMoN25-7-4 1.4410
K	Gusswerkstoffe 1.1 Gusseisen mit Lamellengrafit (GJL)	Cast materials Cast iron with lamellar graphite (GJL)	EN-GJL-200 (GG20) EN-JL-1030 250-450 N/mm ² EN-JL-1050
	1.2 Gusseisen mit Kugelgrafit (GJS)	Cast iron with nodular graphite (GJS)	EN-GJS-400-15 (GGG40) EN-JS-1030 500-900 N/mm ² EN-GJS-700-2 (GGG70) EN-JS-1070
	2.1 Gusseisen mit Kugelgrafit (GJS)	Cast iron with nodular graphite (GJS)	EN-GJS-400-15 (GGG40) EN-JS-1030 500-900 N/mm ² EN-GJS-700-2 (GGG70) EN-JS-1070
	2.2 Gusseisen mit Kugelgrafit (GJS)	Cast iron with nodular graphite (GJS)	EN-GJS-400-15 (GGG40) EN-JS-1030 500-900 N/mm ² EN-GJS-700-2 (GGG70) EN-JS-1070
	3.1 Gusseisen mit Vermiculargrafit (GJV)	Cast iron with vermicular graphite (GJV)	GJV 300 400-500 N/mm ² GJV 450
	3.2 Gusseisen mit Vermiculargrafit (GJV)	Cast iron with vermicular graphite (GJV)	GJV 300 400-500 N/mm ² GJV 450
	4.1 Temperguss (GTMW, GTMB)	Malleable cast iron (GTMW, GTMB)	EN-GJMW-350-4 (GTW-35) EN-JM-1010 500-800 N/mm ² EN-GJMB-450-6 (GTS-45) EN-JM-1140
N	Nichteisenwerkstoffe 1.1 Aluminium-Legierungen	Non ferrous materials Aluminium alloys	EN AW-AlMn1 EN AW-3103 EN AW-AlMgSi EN AW-6060 EN AW-AlZn5Mg3Cu EN AW-7022 EN AC-AlMg5 EN AC-51300 EN AC-AISi9Cu3 EN AC-46500 GD-AISi17Cu4FeMg
	1.2 Aluminium-Knetlegierungen	Aluminium wrought alloys	EN AW-AlMn1 EN AW-3103 EN AW-AlMgSi EN AW-6060 EN AW-AlZn5Mg3Cu EN AW-7022 EN AC-AlMg5 EN AC-51300 EN AC-AISi9Cu3 EN AC-46500 GD-AISi17Cu4FeMg
	1.3 Aluminium-Knetlegierungen	Aluminium wrought alloys	EN AW-AlMn1 EN AW-3103 EN AW-AlMgSi EN AW-6060 EN AW-AlZn5Mg3Cu EN AW-7022 EN AC-AlMg5 EN AC-51300 EN AC-AISi9Cu3 EN AC-46500 GD-AISi17Cu4FeMg
	1.4 Aluminium-Knetlegierungen	Aluminium wrought alloys	EN AW-AlMn1 EN AW-3103 EN AW-AlMgSi EN AW-6060 EN AW-AlZn5Mg3Cu EN AW-7022 EN AC-AlMg5 EN AC-51300 EN AC-AISi9Cu3 EN AC-46500 GD-AISi17Cu4FeMg
	1.5 Aluminium-Gusslegierungen	Aluminium cast alloys	EN AW-AlMn1 EN AW-3103 EN AW-AlMgSi EN AW-6060 EN AW-AlZn5Mg3Cu EN AW-7022 EN AC-AlMg5 EN AC-51300 EN AC-AISi9Cu3 EN AC-46500 GD-AISi17Cu4FeMg
	1.6 Aluminium-Gusslegierungen	Aluminium cast alloys	EN AW-AlMn1 EN AW-3103 EN AW-AlMgSi EN AW-6060 EN AW-AlZn5Mg3Cu EN AW-7022 EN AC-AlMg5 EN AC-51300 EN AC-AISi9Cu3 EN AC-46500 GD-AISi17Cu4FeMg
	2.1 Reinkupfer, niedriglegiertes Kupfer	Pure copper, low-alloyed copper	E-Cu 57 EN CW 004 A
	2.2 Kupfer-Zink-Legierungen (Messing, langspanend)	Copper-zinc alloys (brass, long-chipping)	CuZn37 (Ms63) EN CW 508 L
	2.3 Kupfer-Zink-Legierungen (Messing, kurzspanend)	Copper-zinc alloys (brass, short-chipping)	CuZn36Pb3 (Ms58) EN CW 603 N
	2.4 Kupfer-Aluminium-Legierungen (Alubronze, langspanend)	Copper-aluminium alloys (alu bronze, long-chipping)	CuAl10Ni5Fe4 EN CW 307 G
	2.5 Kupfer-Zinn-Legierungen (Zinnbronze, langspanend)	Copper-tin alloys (tin bronze, long-chipping)	CuSn8P EN CW 459 K
	2.6 Kupfer-Zinn-Legierungen (Zinnbronze, kurzspanend)	Copper-tin alloys (tin bronze, short-chipping)	CuSn7 ZnPb (Rg7) 2.1090
	2.7 Kupfer-Sonderlegierungen	Special copper alloys	(AMPCO® 8)
	2.8 Kupfer-Sonderlegierungen	Special copper alloys	(AMPCO® 45)
	3.1 Magnesium-Knetlegierungen	Magnesium wrought alloys	MgAl6Zn 3.5612
	3.2 Magnesium-Gusslegierungen	Magnesium cast alloys	EN-MCMgAl9Zn1 EN-MC21120
S	Kunststoffe 4.1 Duroplaste (kurzspanend)	Synthetics Duroplastics (short-chipping)	Bakelit, Pertinax
	4.2 Thermoplaste (langspanend)	Thermoplastics (long-chipping)	PMMA, POM, PVC
	4.3 Faserverstärkte Kunststoffe (Faseranteil ≤ 30%)	Fibre-reinforced synthetics (fibre content ≤ 30%)	GFK, CFK, AFK
	4.4 Faserverstärkte Kunststoffe (Faseranteil > 30%)	Fibre-reinforced synthetics (fibre content > 30%)	GFK, CFK, AFK
H	Besondere Werkstoffe 5.1 Grafit	Special materials Graphite	C 8000
	5.2 Wolfram-Kupfer-Legierungen	Tungsten-copper alloys	W-Cu 80/20
	5.3 Verbundwerkstoffe	Composite materials	Hyllite, Alucobond
S	Spezialwerkstoffe Titan-Legierungen	Special materials Titanium alloys	Ti1 3.7025 TiAl6V4 3.7165 TiAl4Mo4Sn2 3.7185
	1.1 Reintitan	Pure titanium	Ti1 3.7025 TiAl6V4 3.7165 TiAl4Mo4Sn2 3.7185
	1.2 Titan-Legierungen	Titanium alloys	Ti1 3.7025 TiAl6V4 3.7165 TiAl4Mo4Sn2 3.7185
	1.3 Titan-Legierungen	Titanium alloys	Ti1 3.7025 TiAl6V4 3.7165 TiAl4Mo4Sn2 3.7185
	2.1 Nickel-, Kobalt- und Eisen-Legierungen	Nickel alloys, cobalt alloys and iron alloys	Ni 99.6 2.4060 Monel 400 2.4360 Inconel 718 2.4668 Udimet 605 Haynes 25 2.4964 Incoloy 800 1.4958
	2.2 Reinnickel	Pure nickel	Ni 99.6 2.4060 Monel 400 2.4360 Inconel 718 2.4668 Udimet 605 Haynes 25 2.4964 Incoloy 800 1.4958
	2.3 Nickel-Basis-Legierungen	Nickel-base alloys	Ni 99.6 2.4060 Monel 400 2.4360 Inconel 718 2.4668 Udimet 605 Haynes 25 2.4964 Incoloy 800 1.4958
	2.4 Nickel-Basis-Legierungen	Nickel-base alloys	Ni 99.6 2.4060 Monel 400 2.4360 Inconel 718 2.4668 Udimet 605 Haynes 25 2.4964 Incoloy 800 1.4958
	2.5 Kobalt-Basis-Legierungen	Cobalt-base alloys	Ni 99.6 2.4060 Monel 400 2.4360 Inconel 718 2.4668 Udimet 605 Haynes 25 2.4964 Incoloy 800 1.4958
	2.6 Eisen-Basis-Legierungen	Iron-base alloys	Ni 99.6 2.4060 Monel 400 2.4360 Inconel 718 2.4668 Udimet 605 Haynes 25 2.4964 Incoloy 800 1.4958
H	Harte Werkstoffe 1.1 Hochfeste Stähle, gehärtete Stähle, Hartguss	Hard materials High strength steels, hardened steels, hard castings	Weldox 1100 Hardox 550 Armax 600T Ferro-Titanit HSSE
	1.2 Hochfeste Stähle, gehärtete Stähle, Hartguss	High strength steels, hardened steels, hard castings	Weldox 1100 Hardox 550 Armax 600T Ferro-Titanit HSSE
	1.3 Hochfeste Stähle, gehärtete Stähle, Hartguss	High strength steels, hardened steels, hard castings	Weldox 1100 Hardox 550 Armax 600T Ferro-Titanit HSSE
	1.4 Hochfeste Stähle, gehärtete Stähle, Hartguss	High strength steels, hardened steels, hard castings	Weldox 1100 Hardox 550 Armax 600T Ferro-Titanit HSSE
	1.5 Hochfeste Stähle, gehärtete Stähle, Hartguss	High strength steels, hardened steels, hard castings	Weldox 1100 Hardox 550 Armax 600T Ferro-Titanit HSSE



Drück STEEL NT

Drück STEEL CR

Drück STEEL TIN

Drück STEEL-SN NT

Drück STEEL-SN CR

Drück STEEL-SN TIN

VHM-Drück STEEL SN-IKZ

InnoForm STEEL-BL/D PM-TIN

InnoForm STEEL-M-SN PM-TIN-66

C / 2-3

C / 2-3

C / 2-3

C / 2-3

C / 2-3

C / 2-3

C / 2-3

D / 4-5

C / 2-3



Gewindetiefe und Lochform
Thread depth and hole type

278

278

278, 287
294, 296
299, 300
301, 302

278

278

279, 287
294, 296
299, 300
301, 302

279

279

279, 287
296

M
MF
UNC
UNF
G
SELF-LOCK
Tech. Info
UNEf, UN-8
G, Rp
NPSM, NPSF
NPT, NPTF, Rc
W
BSW, BSF
Pg
MJ
UNJC, UNJF
EG (ST)
LK-M
Tr, Tr-F, Rd

Seite · Page

15 - 45

20 - 80

15 - 45

20 - 80

20 - 80

20 - 80

1.1

10 - 40

20 - 60

10 - 40

20 - 60

20 - 60

20 - 60

2.1

5 - 25

10 - 40

5 - 25

10 - 40

10 - 40

10 - 40

3.1

P

2 - 20

10 - 30

10 - 30

4.1

5.1

10 - 25 ²⁾
10 - 25 ²⁾

10 - 25 ²⁾
10 - 25 ²⁾

1.1
2.1
3.1
4.1

M

20 - 60

1.1
1.2
2.1
2.2
3.1
3.2
4.1
4.2

K

15 - 40
15 - 40
15 - 40
15 - 40

15 - 40
15 - 40
15 - 40
15 - 40

20 - 60
20 - 60

20 - 60
20 - 60

1.1
1.2
1.3
1.4
1.5
1.6

5 - 30
20 - 60

20 - 40
40 - 80

5 - 30
20 - 60

20 - 40
40 - 80

2.1
2.2
2.3
2.4
2.5
2.6
2.7
2.8

N

3.1
3.2

4.1
4.3
4.4

5.1
5.2
5.3

1.1
1.2
1.3

S

2.1
2.2
2.3
2.4
2.5
2.6

1.1
1.2
1.3
1.4
1.5

H



- Product Finder
- Vc
- M
- MF
- UNC
- UNF
- G
- SELF-LOCK
- Tech. Info

	InnoForm STEEL-M-SN IKZ-PM-TIN-66	InnoForm STEEL-M/E-SN IKZ-PM-TIN-66	InnoForm STEEL-H-SN IKZ-PM-TICN-67	InnoForm STEEL-H-SN IKZ-PM-TICN-67	InnoForm STEEL-H/E-SN IKZ-PM-TICN-67	InnoForm VA/E-SN PM-TIN-T26	InnoForm VA/E-SN-IKZ PM-TIN-T26	InnoForm AL PM-GLT-8	InnoForm AL-SN PM-GLT-8	InnoForm AL-SN-IKZ PM-GLT-8
	C / 2-3		E / 1,5-2		C / 2-3		E / 1,5-2		C / 2-3	
Gewindetiefe und Lochform Thread depth and hole type	max. 3 x d ₁ 		max. 3 x d ₁ 		max. 3 x d ₁ 		max. 3 x d ₁ 		max. 3 x d ₁ 	
M	279, 287	279, 287	279, 288	279, 288	280, 288	280	280	281	281	281
MF	296	296	297	297	297					
UNC										
UNF										
G										
SELF-LOCK										
Tech. Info										
W										
BSW, BSF										
Pg										
MJ										
UNJC, UNJF										
EG (STI)										
LK-M										
Tr, Tr-F, Rd										
P	1.1	20 - 80	20 - 80			20 - 80	20 - 80			
	2.1	20 - 60	20 - 60			20 - 60	20 - 60			
	3.1	10 - 40	10 - 40	10 - 40	10 - 40	10 - 40	10 - 40	10 - 40		
	4.1	10 - 30	10 - 30	10 - 30	10 - 30	10 - 30	10 - 30	10 - 30		
	5.1			10 - 20	10 - 20	10 - 20				
M	1.1					10 - 25 ²⁾	10 - 25 ²⁾			
	2.1					10 - 25 ²⁾	10 - 25 ²⁾			
	3.1					5 - 20 ²⁾	5 - 20 ²⁾			
	4.1									
K	1.1									
	1.2									
	2.1	20 - 60	20 - 60	20 - 60	20 - 60	20 - 60				
	2.2									
	3.1									
	3.2									
	4.1									
N	1.1							20 - 60	20 - 60	20 - 60
	1.2							20 - 60	20 - 60	20 - 60
	1.3							20 - 60	20 - 60	20 - 60
	1.4							20 - 60	20 - 60	20 - 60
	1.5							20 - 60	20 - 60	20 - 60
	1.6									
	2.1							20 - 40	20 - 40	20 - 40
	2.2							40 - 80	40 - 80	40 - 80
	2.3									
	2.4									
	2.5									
	2.6									
	2.7									
2.8										
S	3.1									
	3.2									
	4.1									
	4.2									
	4.3									
	4.4									
H	5.1									
	5.2									
	5.3									
	1.1									
	1.2									

Seite . Page

Vc in m/min

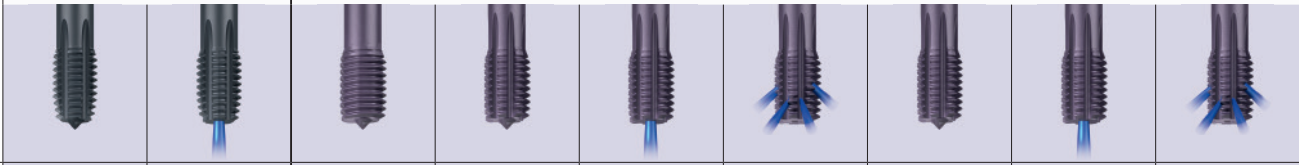

InnoForm AL/E-SN PM-GLT-8	InnoForm AL/E-SN- IKZ PM-GLT-8	InnoForm GAL PM-TICN	InnoForm GAL-SN PM-TICN	InnoForm GAL-SN- IKZ PM-TICN	InnoForm GAL-SN- IKZN PM-TICN	InnoForm GAL/E-SN PM-TICN	InnoForm GAL/E-SN- IKZ PM-TICN	InnoForm GAL/E-SN- IKZN PM-TICN
---------------------------------	---	----------------------------	-------------------------------	---------------------------------------	--	---------------------------------	---	--

E / 1,5-2	E / 1,5-2	C / 2-3	C / 2-3	C / 2-3	C / 2-3	E / 1,5-2	E / 1,5-2	E / 1,5-2
-----------	-----------	---------	---------	---------	---------	-----------	-----------	-----------

max. 3 x d ₁	max. 3 x d ₁	max. 3 x d ₁		max. 3 x d ₁	max. 3 x d ₁		max. 3 x d ₁	max. 3 x d ₁
-------------------------	-------------------------	-------------------------	--	-------------------------	-------------------------	--	-------------------------	-------------------------

281	281	281	281	281	281	282	282	282
-----	-----	-----	-----	-----	-----	-----	-----	-----



Gewindetiefe und Lochform
Thread depth and hole type

M
MF
UNC
UNF
UNEJ, UN-8
G, Rp
NPSM, NPSF
NPT, NPTF, Rc
W
BSW, BSF
Pg
MJ
UNJC, UNJF
EG (ST)
LK-M
Tr, Tr-F, Rd

Product
Finder

V_c

M

MF

UNC

UNF

G

SELF-LOCK

Tech. Info

Seite · Page

										1.1
										2.1
										3.1
										4.1
										5.1
										1.1
										2.1
										3.1
										4.1
										1.1
										1.2
										2.1
										2.2
										3.1
										3.2
										4.1
										4.2
										1.1
										1.2
										1.3
										1.4
										1.5
										1.6
										2.1
										2.2
										2.3
										2.4
										2.5
										2.6
										2.7
										2.8
										3.1
										3.2
										4.1
										4.2
										4.3
										4.4
										5.1
										5.2
										5.3
										1.1
										1.2
										1.3
										2.1
										2.2
										2.3
										2.4
										2.5
										2.6
										1.1
										1.2
										1.3
										1.4
										1.5



- Product Finder
- Vc
- M
- MF
- UNC
- UNF
- G
- SELF-LOCK
- Tech. Info

	InnoForm H-SN PM-TIN-T26	InnoForm H-SN-IKZ PM-TIN-T26	InnoForm H-SN-IKZ-LF3 PM-TIN-T26	InnoForm H-SN-IKZN-LF3 PM-TIN-T26	InnoForm H-SN-IKZ-LF4 PM-TIN-T26	InnoForm H-SN-IKZN-LF4 PM-TIN-T26	InnoForm Z PM-TIN-80	InnoForm Z-SN PM-TIN-80
	C / 2-3	C / 2-3	C / 2-3	C / 2-3	C / 2-3	C / 2-3	C / 2-3	C / 2-3
Gewindetiefe und Lochform Thread depth and hole type	max. 3 x d ₁ 	max. 3 x d ₁ 	max. 3 x d ₁ 	max. 3 x d ₁ 	max. 4 x d ₁ 	max. 4 x d ₁ 	max. 3 x d ₁ 	
M	283, 289	283, 289	292	292	293	293	283, 289	283, 286, 289
MF	297	297						295, 297
UNC								299, 300
UNF								301, 302
G								303
SELF-LOCK								
Tech. Info								

Seite . Page

P	1.1						20 - 80	20 - 80
	2.1	20 - 60	20 - 60	20 - 60	20 - 60	20 - 60	20 - 60	20 - 60
	3.1	10 - 40	10 - 40	10 - 40	10 - 40	10 - 40	10 - 40	10 - 40
	4.1	10 - 30	10 - 30	10 - 30	10 - 30	10 - 30	10 - 30	10 - 30
	5.1	5 - 20	5 - 20	5 - 20	5 - 20	5 - 20	5 - 20	5 - 20
M	1.1						10 - 25 ²⁾	10 - 25 ²⁾
	2.1						10 - 25 ²⁾	10 - 25 ²⁾
	3.1						5 - 20 ²⁾	5 - 20 ²⁾
	4.1							
K	1.1							
	1.2							
	2.1	20 - 60	20 - 60	20 - 60	20 - 60	20 - 60	20 - 60	20 - 60
	2.2							
	3.1							
	3.2							
	4.1							
4.2								
N	1.1							
	1.2							
	1.3							
	1.4							
	1.5							
	1.6							
	2.1						20 - 40	20 - 40
	2.2						40 - 80	40 - 80
	2.3							
	2.4						20 - 40	20 - 40
	2.5						20 - 40	20 - 40
	2.6							
	2.7							
	2.8							
	3.1							
3.2								
4.1								
4.2								
4.3								
4.4								
5.1								
5.2								
5.3								
S	1.1						5 - 20 ²⁾	5 - 20 ²⁾
	1.2						5 - 15 ²⁾	5 - 15 ²⁾
	1.3						5 - 10 ²⁾	5 - 10 ²⁾
	2.1						5 - 10 ²⁾	5 - 10 ²⁾
	2.2						5 - 10 ²⁾	5 - 10 ²⁾
	2.3						5 - 10 ²⁾	5 - 10 ²⁾
2.4								
2.5						5 - 10 ²⁾	5 - 10 ²⁾	
2.6								
H	1.1							
	1.2							
	1.3							
	1.4							
	1.5							

¹⁾ Gewindeformen in Durchganglöcher nur mit externer Kühlschmierung möglich
Cold-forming in through holes is possible only with external cooling/lubrication

²⁾ Mit Emulsion nur bedingt einsetzbar
Restricted application possibilities with emulsion

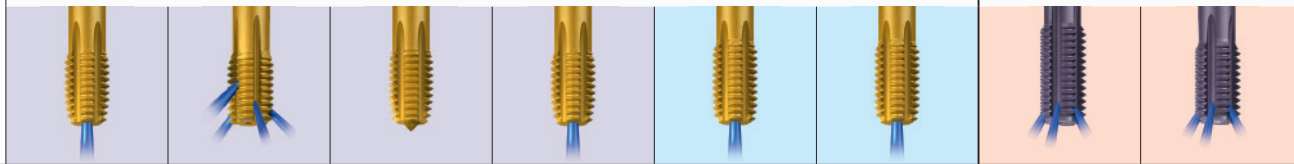

InnoForm Z-SN- PM-TIN-80	InnoForm Z-SN- IKZN PM-TIN-80	InnoForm Z/E-SN PM-TIN-80	InnoForm Z/E-SN- IKZ PM-TIN-80	VHM-InnoForm Z-SN- IKZ TIN-80	VHM-InnoForm Z/E-SN- IKZ TIN-80	Drück GAL-SPEED/E SN- IKZN-TICN	VHM-Drück GAL-SPEED/E SN- IKZN-TICN
C / 2-3	C / 2-3	E / 1,5-2	E / 1,5-2	C / 2-3	E / 1,5-2	E / 1,5-2	E / 1,5-2
max. 3 x d ₁ 	max. 3 x d ₁ 			max. 3 x d ₁ 		max. 3 x d ₁ 	
283, 286, 289, 291 295, 297 299, 300 301, 302 303	283, 289	283, 289	283, 289	284	284	285, 290 295, 298	285, 290 295, 298



Gewindetiefe und Lochform
Thread depth and hole type

M
MF
UNC
UNF
G
SELF-LOCK
Tech. Info

UNE, UN-8
G, Rp
NPSM, NPSF
NPT, NPTF, Rc
W
BSW, BSF
Pg
MJ
UNJC, UNJF
EG (ST)
LK-M
Tr, Tr-F, Rd

Seite . Page

20 - 80	20 - 80	20 - 80	20 - 80					1.1
20 - 60	20 - 60	20 - 60	20 - 60	20 - 60	20 - 60			2.1
10 - 40	10 - 40	10 - 40	10 - 40	10 - 40	10 - 40			3.1
10 - 30	10 - 30	10 - 30	10 - 30	10 - 30	10 - 30			4.1
5 - 20	5 - 20	5 - 20	5 - 20	5 - 20	5 - 20			5.1
10 - 25 ²⁾	10 - 25 ²⁾	10 - 25 ²⁾	10 - 25 ²⁾					1.1
10 - 25 ²⁾	10 - 25 ²⁾	10 - 25 ²⁾	10 - 25 ²⁾					2.1
5 - 20 ²⁾	5 - 20 ²⁾	5 - 20 ²⁾	5 - 20 ²⁾					3.1
								4.1
								1.1
20 - 60	20 - 60	20 - 60	20 - 60					1.2
								2.1
								2.2
								3.1
								3.2
								4.1
								4.2
								1.1
								1.2
								1.3
				20 - 80	20 - 80	20 - 80	40 - 160	1.4
				20 - 80	20 - 80	20 - 80	40 - 160	1.5
								1.6
20 - 40	20 - 40	20 - 40	20 - 40					2.1
40 - 80	40 - 80	40 - 80	40 - 80					2.2
								2.3
20 - 40	20 - 40	20 - 40	20 - 40	20 - 40	20 - 40			2.4
20 - 40	20 - 40	20 - 40	20 - 40	20 - 40	20 - 40			2.5
								2.6
								2.7
								2.8
								3.1
								3.2
								4.1
								4.2
								4.3
								4.4
								5.1
								5.2
								5.3
5 - 20 ²⁾	5 - 20 ²⁾	5 - 20 ²⁾	5 - 20 ²⁾					1.1
5 - 15 ²⁾	5 - 15 ²⁾	5 - 15 ²⁾	5 - 15 ²⁾					1.2
5 - 10 ²⁾	5 - 10 ²⁾	5 - 10 ²⁾	5 - 10 ²⁾					1.3
5 - 10 ²⁾	5 - 10 ²⁾	5 - 10 ²⁾	5 - 10 ²⁾					2.1
5 - 10 ²⁾	5 - 10 ²⁾	5 - 10 ²⁾	5 - 10 ²⁾					2.2
								2.3
5 - 10 ²⁾	5 - 10 ²⁾	5 - 10 ²⁾	5 - 10 ²⁾					2.4
								2.5
								2.6
								1.1
								1.2
								1.3
								1.4
								1.5

Product Finder

v_c

M

MF

UNC

UNF

G

SELF-LOCK

Tech. Info



- Product Finder
- Vc
- M
- MF
- UNC
- UNF
- G
- SELF-LOCK
- Tech. Info

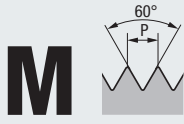

M
DIN 13

DIN 2174

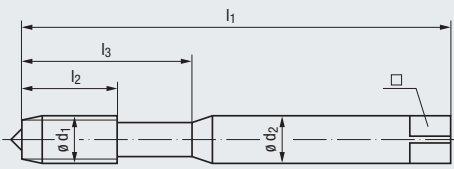

STEEL
Steel materials



Toleranz · Tolerance
Beschichtung · Coating
Schneidstoff · Cutting material

6HX	6HX	6HX	6HX	6HX
NT	CR	TIN	NT	CR
HSSE	HSSE	HSSE	HSSE	HSSE
C / 2-3	C / 2-3	C / 2-3	C / 2-3	C / 2-3
O / P	E / O	E / O / P	O / P	E / O

Technische Informationen
Technical information

» 305 - 324



Gewindetiefe und Lochform
Thread depth and hole type

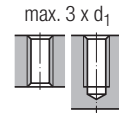

Einsatzgebiete – Material
Application – material

» 272

P 1.1-3.1	N 1.1-4, 2.1-2	P 1.1-3.1 M 1.1-2.1 2 N 1.4-5, 2.1-2	P 1.1-3.1	N 1.1-4, 2.1-2
-----------	----------------	--	-----------	----------------

Werkzeug-Ident · Tool ident

Ø d ₁ mm	P mm	l ₁	l ₂	l ₃	Ø d ₂	□	Image	Dimens.- Ident	B0911000	B0911300	B0911400	B0921000	B0921300
									Drück 1-STEEL NT	Drück 1-STEEL CR	Drück 1-STEEL TIN	Drück 1-STEEL-SN NT	Drück 1-STEEL-SN CR
M 1	0,25	40	5	–	2,5	2,1	0,9	.0010	● *)				
1,1	0,25	40	5	–	2,5	2,1	1	.0011	● *)				
1,2	0,25	40	5	–	2,5	2,1	1,1	.0012	● *)				
1,4	0,3	40	6	–	2,5	2,1	1,28	.0014	● *)				
1,6	0,35	40	6	11	2,5	2,1	1,47	.0016	●		●		
1,7	0,35	40	6	11	2,5	2,1	1,57	.0017	●				
1,8	0,35	40	6	11	2,5	2,1	1,67	.0018	●				
2	0,4	45	7	12	2,8	2,1	1,85	.0020	●	●	●	○	●
2,2	0,45	45	7	12	2,8	2,1	2,03	.0022	●			○	
2,3	0,4	45	7	12	2,8	2,1	2,15	.0023	●			○	
2,5	0,45	50	9	14	2,8	2,1	2,33	.0025	●	●	●	○	●
2,6	0,45	50	9	14	2,8	2,1	2,43	.0026	●		○	○	
3	0,5	56	11	18	3,5	2,7	2,8	.0030	●	●	●	○	●
3,5	0,6	56	12	20	4	3	3,25	.0035	●	●	●	○	
4	0,7	63	13	21	4,5	3,4	3,7	.0040	●	●	●	●	●
4,5	0,75	70	14	25	6	4,9	4,2	.0045	●	●	●	●	●
5	0,8	70	15	25	6	4,9	4,65	.0050	●	●	●	●	●
5,5	0,9	80	16	30	6	4,9	5,1	.0055	●	●	●	●	●
6	1	80	17	30	6	4,9	5,6	.0060	●	●	●	●	●
7	1	80	17	30	7	5,5	6,6	.0070	●		●	○	
8	1,25	90	20	35	8	6,2	7,45	.0080	●	●	●	●	●
9	1,25	90	20	35	9	7	8,45	.0090	●		●	●	●
10	1,5	100	22	39	10	8	9,35	.0100	●	●	●	●	●
12	1,75	110	24	44	12	9	11,25	.0112					

DIN 2174

» 272

*) ≤ M1,4 Tol. 4HX/5HX

Bei schlecht ausformenden Werkstoffen (z.B. GAL) empfehlen wir bei P ≥ 1 mm um 0,05 mm kleiner vorzubohren.
Weitere Informationen zu den empfohlenen Vorfertigungsdurchmessern siehe Seite 321.

We recommend a smaller preparatory diameter by 0.05 mm for difficult to form materials (such as aluminium cast alloys) for P ≥ 1 mm.
For further information regarding the recommended preparatory diameters, see page 321.

STEEL
Steel
materials

Product
Finder

Vc

M

MF

UNC

UNF

G

SELF-LOCK

Tech. Info

		new		new		new		new		new	
6HX	6HX	6GX	6GX	6HX	6HX	6HX	6HX	6HX	6HX	6HX	6HX
TIN		TIN	TIN	TIN	TIN-66	TIN-66	TIN-66	TIN	TIN	TICN-67	TICN-67
HSSE	VHM	HSSE	HSSE	HSSE-PM	HSSE-PM	HSSE-PM	HSSE-PM	HSSE-PM	HSSE-PM	HSSE-PM	HSSE-PM
C / 2-3	C / 2-3	C / 2-3	C / 2-3	D / 4-5	C / 2-3	C / 2-3	E / 1,5-2	C / 2-3	C / 2-3	C / 2-3	C / 2-3
E / O / P	E / O	E / O / P	E / O / P	E / O / P	E / O / P	E / O	E / O	E / O / P	E / O / P	E / O	E / O
max. 3 x d ₁	max. 3 x d ₁	max. 3 x d ₁		max. 3 x d ₁	max. 3 x d ₁	max. 3 x d ₁		max. 3 x d ₁	max. 3 x d ₁	max. 3 x d ₁	max. 3 x d ₁
P 1.1-3.1	P 2.1-4.1	P 1.1-3.1	P 1.1-3.1	P 1.1-4.1	P 1.1-4.1	P 1.1-4.1	P 1.1-4.1	P 3.1-5.1	P 3.1-5.1	P 3.1-5.1	P 3.1-5.1
M 1.1-2.1	N 1.4-5	M 1.1-2.1	M 1.1-2.1		K 2.1	K 2.1	K 2.1	K 2.1	K 2.1	K 2.1	K 2.1
N 1.4-5, 2.1-2		N 1.4-5, 2.1-2	N 1.4-5, 2.1-2								
B0921400	B1970100	B0911420	B0921420	B535P300	B5217F00	B5237F00	B5317F00	B5216F00	B5236F00	B5236F00	B5236F00
Drück 1-STEEL-SN TIN	VHM Drück 1-STEEL SN-IKZ	Drück 1-STEEL TIN „6GX“	Drück 1-STEEL-SN TIN „6GX“	InnoForm 1-STEEL-BL/D PM-TIN	InnoForm 1-STEEL-M SN-PM TIN-66	InnoForm 1-STEEL-M SN-IKZ-PM TIN-66	InnoForm 1-STEEL-M/E SN-IKZ-PM TIN-66	InnoForm 1-STEEL-H SN-PM TICN-67	InnoForm 1-STEEL-H SN-PM TICN-67	InnoForm 1-STEEL-H SN-PM TICN-67	InnoForm 1-STEEL-H SN-PM TICN-67
											M 1
											1,1
											1,2
											1,4
											1,6
											1,7
											1,8
•		•	•								2
											2,2
•		•	•								2,3
○		○	○								2,5
•		•	•	•	•						2,6
•		•	•								3
•		•	•								3,5
•		•	•	•	•			•	•		4
•		•	•	•	•			•	•		4,5
•	•	•	•	•	•			•	•		5
•		•	•	•	•			•	•		5,5
•		•	•	•	•			•	•		6
•		•	•	•	•			•	•		7
•		•	•	•	•			•	•		8
•		•	•	•	•			•	•		9
•		•	•	•	•			•	•		10
											12
📄 287					📄 287	📄 287	📄 287	📄 288	📄 288	📄 288	

1) Gewindeformen in Durchgangslöcher nur mit externer Kühlschmierung möglich
Cold-forming in through holes is possible only with external cooling/lubrication

2) Mit Emulsion nur bedingt einsetzbar
Restricted application possibilities with emulsion

3) Zum Patent angemeldet
Patent pending

- Product Finder
- Vc
- M
- MF
- UNC
- UNF
- G
- SELF-LOCK
- Tech. Info

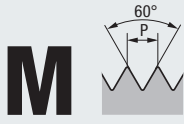

M
DIN 13

DIN 2174

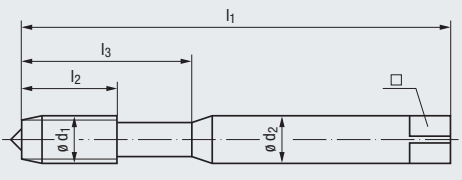

Technische Informationen Technical information	Toleranz · Tolerance Beschichtung · Coating Schneidstoff · Cutting material	6HX TICN-67 HSSE-PM E / 1,5-2 E / 0	6HX TIN-T26 HSSE-PM E / 1,5-2 E / 0 / P	6HX TIN-T26 HSSE-PM E / 1,5-2 E / 0
		max. 3 x d ₁ 	max. 3 x d ₁ 	max. 3 x d ₁
Einsatzgebiete – Material Application – material	P 3.1-5.1 K 2.1	P 1.1-4.1 M 1.1-3.1 2)	P 1.1-4.1 M 1.1-3.1 2)	















Werkzeug-Ident · Tool ident										B5316F00	B5296A00	B5316A00
M	Ø d ₁ mm	P mm	l ₁	l ₂	l ₃	Ø d ₂	□		Dimens.-Ident	InnoForm 1-STEEL-H/E SN-IKZ-PM TICN-67	InnoForm 1-VA/E-SN PM-TIN-T26	InnoForm 1-VA/E-SN IKZ-PM TIN-T26
										1	1,1	0,25
	1,2	0,25	40	2,5	–	2,5	2,1	1	.0011			
	1,4	0,3	40	3	–	2,5	2,1	1,28	.0012			
	1,6	0,35	40	4	11	2,5	2,1	1,47	.0014			
	1,7	0,35	40	4	11	2,5	2,1	1,57	.0016			
	1,8	0,35	40	4	11	2,5	2,1	1,67	.0017			
	2	0,4	45	4	12	2,8	2,1	1,85	.0018			
	2,2	0,45	45	4,5	12	2,8	2,1	2,03	.0020			
	2,3	0,4	45	4,5	12	2,8	2,1	2,15	.0022			
	2,5	0,45	50	5	14	2,8	2,1	2,33	.0023			
	2,6	0,45	50	5	14	2,8	2,1	2,43	.0025			
	3	0,5	56	6	18	3,5	2,7	2,8	.0026			
	3,5	0,6	56	7	20	4	3	3,25	.0030			
	4	0,7	63	7	21	4,5	3,4	3,7	.0035			
	4,5	0,75	70	8	25	6	4,9	4,2	.0040			
	5	0,8	70	8	25	6	4,9	4,65	.0045			
	5,5	0,9	80	10	30	6	4,9	5,1	.0050			
	6	1	80	10	30	6	4,9	5,6	.0055			
	7	1	80	10	30	7	5,5	6,6	.0060			
	8	1,25	90	14	35	8	6,2	7,45	.0070			
	9	1,25	90	14	35	9	7	8,45	.0080			
	10	1,5	100	16	39	10	8	9,35	.0090			
	12	1,75	110	18	44	12	9	11,25	.0100			
									.0112			

DIN 2174 288

1) Gewindeformen in Durchgangslöcher nur mit externer Kühlschmierung möglich
Cold-forming in through holes is possible only with external cooling/lubrication

2) Mit Emulsion nur bedingt einsetzbar
Restricted application possibilities with emulsion

3) Zum Patent angemeldet
Patent pending

AL Aluminium wrought alloys					GAL Aluminium cast alloys				
									
6HX	6HX	6HX	6HX	6HX	6HX	6HX	6HX	6HX	
GLT-8	GLT-8	GLT-8	GLT-8	GLT-8	TICN	TICN	TICN	TICN	
HSSE-PM	HSSE-PM	HSSE-PM	HSSE-PM	HSSE-PM	HSSE-PM	HSSE-PM	HSSE-PM	HSSE-PM	
C / 2-3	C / 2-3	C / 2-3	E / 1,5-2	E / 1,5-2	C / 2-3	C / 2-3	C / 2-3	C / 2-3	
E / O / P	E / O / P	E / O	E / O / P	E / O	E / O / P	E / O / P	E / O	E / O	
max. 3 x d ₁ 		max. 3 x d ₁ 		max. 3 x d ₁ 		max. 3 x d ₁ 		max. 3 x d ₁ 	
N 1.1-4, 2.1-2	N 1.1-4, 2.1-2	N 1.1-4, 2.1-2	N 1.1-4, 2.1-2	N 1.1-4, 2.1-2	N 1.4-6	N 1.4-6	N 1.4-6	N 1.4-6	
B519Y700	B521Y700	B523Y700	B529Y700	B531Y700	B519Q200	B521Q200	B523Q200	B526Q200	
InnoForm 1-AL-PM GLT-8	InnoForm 1-AL-SN-PM GLT-8	InnoForm 1-AL-SN-PM-GLT-8	InnoForm 1-AL/E-SN PM-GLT-8	InnoForm 1-AL/E-SN IKZ-PM GLT-8	InnoForm 1-GAL-PM TICN	InnoForm 1-GAL-SN PM-TICN	InnoForm 1-GAL-SN IKZ-PM-TICN	InnoForm 1-GAL-SN IKZN-PM TICN	
○ *)								M 1	
○ *)								1,1	
○ *)								1,2	
○	○							1,4	
								1,6	
								1,7	
								1,8	
●	●		●					2	
								2,2	
●	●		●					2,3	
								2,5	
●	●		●					2,6	
								3	
●	●	●	●	●				3,5	
								4	
●	●	●	●	●	●	●	●	4,5	
								5	
●	●	●	●	●	●	●	●	5,5	
								6	
●	●	●	●	●	●	●	●	7	
								8	
●	●	●	●	●	●	●	●	9	
								10	
								12	

*) ≤ M1,4 Tol. 4HX/5HX



Bei schlecht ausformenden Werkstoffen (z.B. GAL) empfehlen wir bei P ≥ 1 mm um 0,05 mm kleiner vorzubohren.

Weitere Informationen zu den empfohlenen Vorfertigungsdurchmessern siehe Seite 321.

We recommend a smaller preparatory diameter by 0.05 mm for difficult to form materials (such as aluminium cast alloys) for P ≥ 1 mm.

For further information regarding the recommended preparatory diameters, see page 321.

- Product Finder
- Vc
- M
- MF
- UNC
- UNF
- G
- SELF-LOCK
- Tech. Info

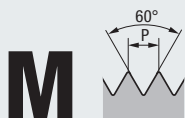

DIN 13

DIN 2174

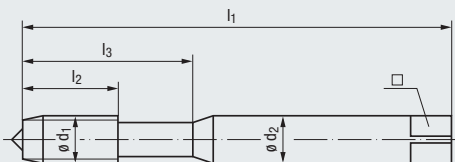

GAL
Aluminium
cast alloys



Toleranz · Tolerance
Beschichtung · Coating
Schneidstoff · Cutting material

Technische Informationen
Technical information

» 305 - 324



6HX	6HX	6HX
TICN	TICN	TICN
HSSE-PM	HSSE-PM	HSSE-PM
E / 1,5-2	E / 1,5-2	E / 1,5-2
E / O / P	E / O	E / O

Gewindetiefe und Lochform
Thread depth and hole type

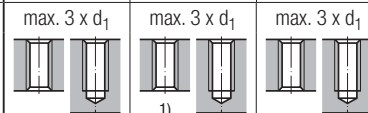

Einsatzgebiete – Material
Application – material

» 272

N 1.4-6

Werkzeug-Ident · Tool ident

B529Q200 B531Q200 B533Q200

M	ø d ₁ mm	P mm	l ₁	l ₂	l ₃	ø d ₂	□	Icon	Dimens.- Ident	InnoForm	InnoForm	InnoForm
										1-GAL/E-SN PM-TICN	1-GAL/E-SN IKZ-PM-TICN	1-GAL/E-SN IKZN-PM TICN
2	2,2	0,4	45	4	12	2,8	2,1	1,85	.0020			
2,2	2,2	0,45	45	4,5	12	2,8	2,1	2,03	.0022			
2,3	2,3	0,4	45	4,5	12	2,8	2,1	2,15	.0023			
2,5	2,5	0,45	50	5	14	2,8	2,1	2,33	.0025			
2,6	2,6	0,45	50	5	14	2,8	2,1	2,43	.0026			
3	3	0,5	56	6	18	3,5	2,7	2,8	.0030			
3,5	3,5	0,6	56	7	20	4	3	3,25	.0035			
4	4	0,7	63	7	21	4,5	3,4	3,7	.0040			
4,5	4,5	0,75	70	8	25	6	4,9	4,2	.0045			
5	5	0,8	70	8	25	6	4,9	4,65	.0050	●	●	○
5,5	5,5	0,9	80	10	30	6	4,9	5,1	.0055			
6	6	1	80	10	30	6	4,9	5,6	.0060	●	●	○
7	7	1	80	10	30	7	5,5	6,6	.0070			
8	8	1,25	90	14	35	8	6,2	7,45	.0080	●	●	○
9	9	1,25	90	14	35	9	7	8,45	.0090			
10	10	1,5	100	16	39	10	8	9,35	.0100	●	●	○
12	12	1,75	110	18	44	12	9	11,25	.0112			

DIN 2174





























1) Gewindeformen in Durchgangslöcher nur mit externer Kühlschmierung möglich
Cold-forming in through holes is possible only with external cooling/lubrication



Bei schlecht ausformenden Werkstoffen (z.B. GAL) empfehlen wir bei P ≥ 1 mm um 0,05 mm kleiner vorzubohren.
Weitere Informationen zu den empfohlenen Vorfertigungsdurchmessern siehe Seite 321.

We recommend a smaller preparatory diameter by 0.05 mm for difficult to form materials (such as aluminium cast alloys) for P ≥ 1 mm.
For further information regarding the recommended preparatory diameters, see page 321.

- Product Finder
- Vc
- M
- MF
- UNC
- UNF
- G
- SELF-LOCK
- Tech. Info

H Materials of high tensile strength		Z CNC-controlled machines							
									
6HX	6HX	6HX	6HX	6HX	6HX	6HX	6HX	6HX	6GX
TIN-T26	TIN-T26	TIN-80	TIN-80	TIN-80	TIN-80	TIN-80	TIN-80	TIN-80	TIN-80
HSSE-PM	HSSE-PM	HSSE-PM	HSSE-PM	HSSE-PM	HSSE-PM	HSSE-PM	HSSE-PM	HSSE-PM	HSSE-PM
C / 2-3	C / 2-3	C / 2-3	C / 2-3	C / 2-3	C / 2-3	E / 1,5-2	E / 1,5-2	E / 1,5-2	C / 2-3
E / O / P	E / O	E / O / P	E / O / P	E / O	E / O	E / O / P	E / O	E / O	E / O / P
max. 3 x d ₁	max. 3 x d ₁	max. 3 x d ₁	max. 3 x d ₁	max. 3 x d ₁	max. 3 x d ₁	max. 3 x d ₁	max. 3 x d ₁	max. 3 x d ₁	max. 3 x d ₁
									
P 2.1-5.1	P 2.1-5.1	P 1.1-5.1	P 1.1-5.1	P 1.1-5.1	P 1.1-5.1	P 1.1-5.1	P 1.1-5.1	P 1.1-5.1	P 1.1-5.1
K 2.1	K 2.1	M 1.1-3.1 ²⁾	M 1.1-3.1 ²⁾	M 1.1-3.1 ²⁾	M 1.1-3.1 ²⁾	M 1.1-3.1 ²⁾	M 1.1-3.1 ²⁾	M 1.1-3.1 ²⁾	M 1.1-3.1 ²⁾
		K 2.1	K 2.1	K 2.1	K 2.1	K 2.1	K 2.1	K 2.1	K 2.1
		N 2.1-2, 2.4-5	N 2.1-2, 2.4-5	N 2.1-2, 2.4-5	N 2.1-2, 2.4-5	N 2.1-2, 2.4-5	N 2.1-2, 2.4-5	N 2.1-2, 2.4-5	N 2.1-2, 2.4-5
		S 1.1-2.2 ²⁾	S 1.1-2.2 ²⁾	S 1.1-2.2 ²⁾	S 1.1-2.2 ²⁾	S 1.1-2.2 ²⁾	S 1.1-2.2 ²⁾	S 1.1-2.2 ²⁾	S 1.1-2.2 ²⁾
		S 2.4 ²⁾	S 2.4 ²⁾	S 2.4 ²⁾	S 2.4 ²⁾	S 2.4 ²⁾	S 2.4 ²⁾	S 2.4 ²⁾	S 2.4 ²⁾
B521W700	B523W700	B519Z700	B521Z700	B523Z700	B526Z700	B529Z700	B531Z700	B521Z720	
InnoForm 1-H-SN-PM TIN-T26	InnoForm 1-H-SN- IKZ PM-TIN-T26	InnoForm 1-Z-PM TIN-80	InnoForm 1-Z-SN-PM TIN-80	InnoForm 1-Z-SN- IKZ PM-TIN-80	InnoForm 1-Z-SN- IKZN PM-TIN-80	InnoForm 1-Z/E-SN PM-TIN-80	InnoForm 1-Z/E-SN- IKZ PM-TIN-80	InnoForm 1-Z-SN-PM TIN-80 „6GX“	
		○	○						M
									2
									2,2
									2,3
									2,5
									2,6
		●	●			●		●	3
		●	●	●	○	●	●	●	3,5
		●	●						4
●	●	●	●	●	○	●	●	●	4,5
●	●	●	●						5
		●	●						5,5
●	●	●	●						6
●	●	●	●						7
●	●	●	●						8
●	●	●	●						9
		●	●						10
									12
 289	 289	 289	 289	 289	 289	 289	 289	 289	

²⁾ Mit Emulsion nur bedingt einsetzbar
Restricted application possibilities with emulsion



Spannzangen-Aufnahmen mit integrierter Übersetzung der Typenreihe Speedsynchro® Modular siehe Seite 683 - 686

Collet holders with integrated transmission of our Speedsynchro® Modular series, see page 683 - 686

- Product Finder
- V_c
- M
- MF
- UNC
- UNF
- G
- SELF-LOCK
- Tech. Info

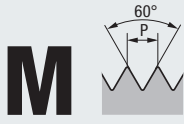

DIN 13

DIN 2174

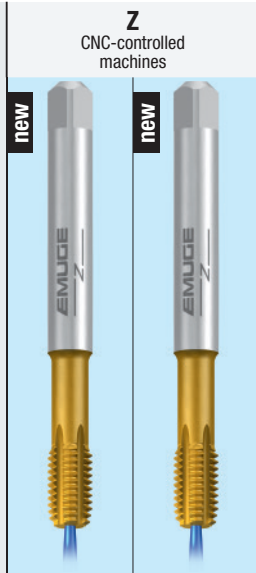
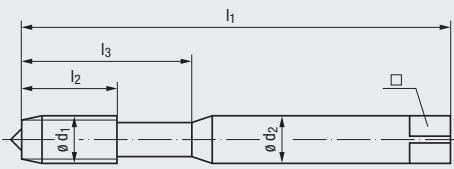

Toleranz · Tolerance
Beschichtung · Coating
Schneidstoff · Cutting material

6HX	6HX
TIN-80	TIN-80
VHM	VHM
C / 2-3	E / 1,5-2
E / 0	E / 0

Technische Informationen
Technical information

» 305 - 324



Gewindetiefe und Lochform
Thread depth and hole type

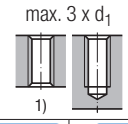

Einsatzgebiete – Material
Application – material

» 272

P 2.1-5.1	P 2.1-5.1
N 1.4-5, 2.4-5	N 1.4-5, 2.4-5

Werkzeug-Ident · Tool ident

B523Z800 B531Z800

M	ø d ₁ mm	P mm	l ₁	l ₂	l ₃	ø d ₂	□	Icon	Dimens.- Ident	VHM InnoForm	
										1-Z-SN- IKZ TIN-80	1-Z/E-SN- IKZ TIN-80
2	2	0,4	45	4	12	2,8	2,1	1,85	.0020		
2,2	2,2	0,45	45	4,5	12	2,8	2,1	2,03	.0022		
2,3	2,3	0,4	45	4,5	12	2,8	2,1	2,15	.0023		
2,5	2,5	0,45	50	5	14	2,8	2,1	2,33	.0025		
2,6	2,6	0,45	50	5	14	2,8	2,1	2,43	.0026		
3	3	0,5	56	6	18	3,5	2,7	2,8	.0030		
3,5	3,5	0,6	56	7	20	4	3	3,25	.0035		
4	4	0,7	63	7	21	4,5	3,4	3,7	.0040		
4,5	4,5	0,75	70	8	25	6	4,9	4,2	.0045		
5	5	0,8	70	8	25	6	4,9	4,65	.0050	•	•
5,5	5,5	0,9	80	10	30	6	4,9	5,1	.0055		
6	6	1	80	10	30	6	4,9	5,6	.0060	•	•
7	7	1	80	10	30	7	5,5	6,6	.0070		
8	8	1,25	90	14	35	8	6,2	7,45	.0080	•	•
9	9	1,25	90	14	35	9	7	8,45	.0090		
10	10	1,5	100	16	39	10	8	9,35	.0100	•	•
12	12	1,75	110	18	44	12	9	11,25	.0112		

1) Gewindeformen in Durchgangslöcher nur mit externer Kühlschmierung möglich
Cold-forming in through holes is possible only with external cooling/lubrication



Bei schlecht ausformenden Werkstoffen (z.B. GAL) empfehlen wir bei P ≥ 1 mm um 0,05 mm kleiner vorzubohren.
Weitere Informationen zu den empfohlenen Vorfertigungsdurchmessern siehe Seite 321.

We recommend a smaller preparatory diameter by 0.05 mm for difficult to form materials (such as aluminium cast alloys) for P ≥ 1 mm.
For further information regarding the recommended preparatory diameters, see page 321.

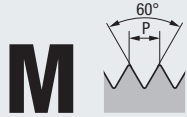

DIN 13

DIN 2174

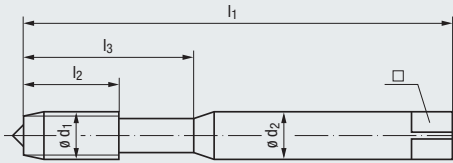

Technische Informationen
Technical information

» 305 - 324

Toleranz · Tolerance
Beschichtung · Coating
Schneidstoff · Cutting material



Gewindetiefe und Lochform
Thread depth and hole type

Einsatzgebiete – Material
Application – material

» 272

Werkzeug-Ident · Tool ident

M	ø d ₁ mm	P mm	l ₁	l ₂	l ₃	ø d ₂	□		Dimens.- Ident	B5059500	B505Q800
										Drück 1-GAL SPEED/E-SN IKZN-TICN	VHM-Drück 1-GAL SPEED/E-SN IKZN-TICN
	2	0,4	45	7	12	2,8	2,1	1,85	.0020		
	2,2	0,45	45	7	12	2,8	2,1	2,03	.0022		
	2,3	0,4	45	7	12	2,8	2,1	2,15	.0023		
	2,5	0,45	50	9	14	2,8	2,1	2,33	.0025		
	2,6	0,45	50	9	14	2,8	2,1	2,43	.0026		
	3	0,5	56	11	18	3,5	2,7	2,8	.0030		
	3,5	0,6	56	12	20	4	3	3,25	.0035		
	4	0,7	63	13	21	4,5	3,4	3,7	.0040	○	○
	4,5	0,75	70	14	25	6	4,9	4,2	.0045		
	5	0,8	70	15	25	6	4,9	4,65	.0050	○	○
	5,5	0,9	80	16	30	6	4,9	5,1	.0055		
	6	1	80	17	30	6	4,9	5,6	.0060	○	○
	7	1	80	17	30	7	5,5	6,6	.0070		
	8	1,25	90	20	35	8	6,2	7,45	.0080	○	○
	9	1,25	90	20	35	9	7	8,45	.0090		
	10	1,5	100	22	39	10	8	9,35	.0100	○	○
	12	1,75	110	24	44	12	9	11,25	.0112		

DIN 2174



» 290

» 290



Bei schlecht ausformenden Werkstoffen (z.B. GAL) empfehlen wir bei P ≥ 1 mm um 0,05 mm kleiner vorzubohren.

Weitere Informationen zu den empfohlenen Vorfertigungsdurchmessern siehe Seite 321.

We recommend a smaller preparatory diameter by 0.05 mm for difficult to form materials (such as aluminium cast alloys) for P ≥ 1 mm.

For further information regarding the recommended preparatory diameters, see page 321.



- Product Finder
- Vc
- M**
- MF
- UNC
- UNF
- G
- SELF-LOCK
- Tech. Info

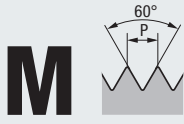

DIN 13

Mit extra langem Schaft
With extra long shank

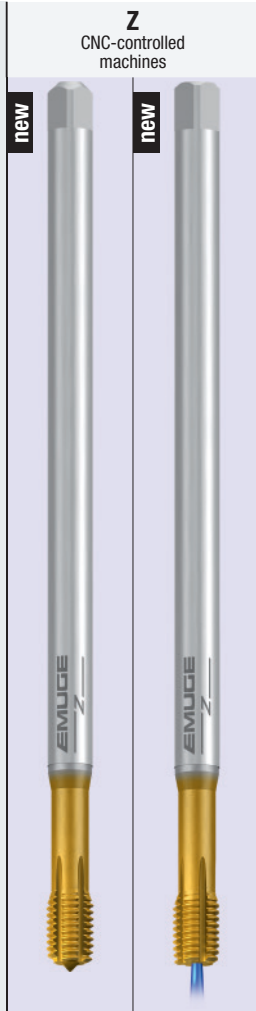
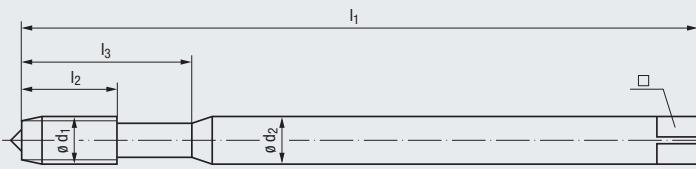

<p>Toleranz · Tolerance</p> <p>Beschichtung · Coating</p> <p>Schneidstoff · Cutting material</p>		<p>6HX</p> <p>TIN-80</p> <p>HSSE-PM</p> <p>C / 2-3</p> <p>E / O / P</p>	<p>6HX</p> <p>TIN-80</p> <p>HSSE-PM</p> <p>C / 2-3</p> <p>E / O</p>									
<p>Technische Informationen Technical information</p> <p>» 305 - 324</p>		<p>max. 3 x d₁</p>										
<p>Gewindetiefe und Lochform Thread depth and hole type</p>												
<p>Einsatzgebiete – Material Application – material</p> <p>» 272</p>		<p>P 1.1-5.1</p> <p>M 1.1-3.1²⁾</p> <p>K 2.1</p> <p>N 2.1-2, 2.4-5</p> <p>S 1.1-2.2²⁾</p> <p>S 2.4²⁾</p>	<p>P 1.1-5.1</p> <p>M 1.1-3.1²⁾</p> <p>K 2.1</p> <p>N 2.1-2, 2.4-5</p> <p>S 1.1-2.2²⁾</p> <p>S 2.4²⁾</p>									
<p>Werkzeug-Ident · Tool ident</p>		B555Z700	B544Z700									
		InnoForm 1-Z-SN-LS PM-TIN-80	InnoForm 1-Z-SN-LS PM-TIN-80									
ø d ₁ mm	P mm	l ₁	l ₂	l ₃	ø d ₂	□		Dimens.-Ident				
M 3	0,5	100	6	18	3,5	2,7	2,8	.0030	●			
4	0,7	125	7	21	4,5	3,4	3,7	.0040	●			
5	0,8	140	8	25	6	4,9	4,65	.0050	●	○		
6	1	160	10	30	6	4,9	5,6	.0060	●	○		
8	1,25	180	14	35	8	6,2	7,45	.0080	●	○		
10	1,5	200	16	39	10	8	9,35	.0100	●	○		
									» 291	» 291		

1) Gewindeformen in Durchgangslöcher nur mit externer Kühlschmierung möglich
Cold-forming in through holes is possible only with external cooling/lubrication

2) Mit Emulsion nur bedingt einsetzbar
Restricted application possibilities with emulsion



Bei schlecht ausformenden Werkstoffen (z.B. GAL) empfehlen wir bei P ≥ 1 mm um 0,05 mm kleiner vorzubohren.
Weitere Informationen zu den empfohlenen Vorfertigungsdurchmessern siehe Seite 321.

We recommend a smaller preparatory diameter by 0.05 mm for difficult to form materials (such as aluminium cast alloys) for P ≥ 1 mm.
For further information regarding the recommended preparatory diameters, see page 321.

M



DIN 13

DIN 2174

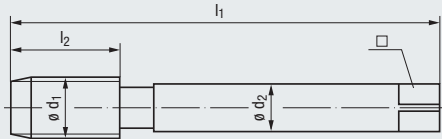

Technische Informationen
Technical information

» 305 - 324

Toleranz · Tolerance
Beschichtung · Coating
Schneidstoff · Cutting material



Gewindetiefe und Lochform
Thread depth and hole type

Einsatzgebiete – Material
Application – material

» 272

Werkzeug-Ident · Tool ident

M	Ø d ₁ mm	P mm	l ₁	l ₂	Ø d ₂	□	 Dimens.- Ident	STEEL Steel materials					
								Drück 2-STEEL TIN	Drück 2-STEEL-SN TIN	InnoForm 2-STEEL-M SN-PM TIN-66	InnoForm 2-STEEL-M SN- IKZ -PM TIN-66	InnoForm 2-STEEL-M/ SN- IKZ -PM TIN-66	
	10	1,5	100	22	7	5,5	9,35	.0100					
	12	1,75	110	24	9	7	11,25	.0112					
	14	2	110	26	11	9	13,1	.0114					
	16	2	110	27	12	9	15,1	.0116					
	18	2,5	125	30	14	11	16,85	.0118					
	20	2,5	140	32	16	12	18,85	.0120					
	22	2,5	140	32	18	14,5	20,85	.0122					
	24	3	160	34	18	14,5	22,6	.0124					
	27	3	160	36	20	16	25,6	.0127					
	30	3,5	180	40	22	18	28,35	.0130					
	33	3,5	180	40	25	20	31,35	.0133					
	36	4	200	50	28	22	34,1	.0136					
	39	4	200	50	32	24	37,1	.0139					
	42	4,5	200	56	32	24	39,85	.0142					
	45	4,5	220	58	36	29	42,85	.0145					
	48	5	250	65	36	29	45,65	.0148					

DIN 2174



» 278

» 279

» 279

» 279

» 279

1) Gewindeformen in Durchgangslöchern nur mit externer Kühlschmierung möglich
Cold-forming in through holes is possible only with external cooling/lubrication

2) Mit Emulsion nur bedingt einsetzbar
Restricted application possibilities with emulsion

3) Zum Patent angemeldet
Patent pending



Bei schlecht ausformenden Werkstoffen (z.B. GAL) empfehlen wir bei P ≥ 1 mm um 0,05 mm kleiner vorzubohren.

Weitere Informationen zu den empfohlenen Vorfertigungsdurchmessern siehe Seite 321.

We recommend a smaller preparatory diameter by 0.05 mm for difficult to form materials (such as aluminium cast alloys) for P ≥ 1 mm.

For further information regarding the recommended preparatory diameters, see page 321.



- Product Finder
- V_c
- M
- MF
- UNC
- UNF
- G
- SELF-LOCK
- Tech. Info

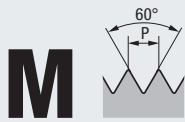

DIN 13

DIN 2174

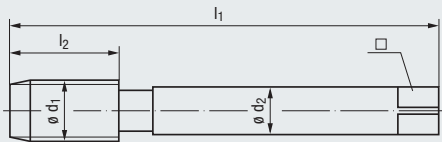

STEEL
Steel materials



Technische Informationen
Technical information

Toleranz · Tolerance
Beschichtung · Coating
Schneidstoff · Cutting material

» 305 - 324



6HX	6HX	6HX
TICN-67	TICN-67	TICN-67
HSSE-PM	HSSE-PM	HSSE-PM
C / 2-3	C / 2-3	E / 1,5-2
E / O / P	E / O	E / O

Gewindetiefe und Lochform
Thread depth and hole type

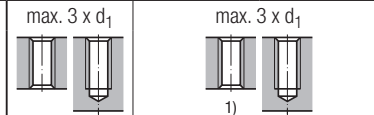

Einsatzgebiete – Material
Application – material

» 272

P 3.1-5.1	P 3.1-5.1	P 3.1-5.1
K 2.1	K 2.1	K 2.1

Werkzeug-Ident · Tool ident

C5216F00 C5236F00 C5316F00

M	Ø d ₁ mm	P mm	l ₁	l ₂	Ø d ₂	□	Image	Dimens.- Ident	InnoForm	InnoForm	InnoForm
									2-STEEL-H SN-PM TICN-67	2-STEEL-H SN-IKZ-PM TICN-67	2-STEEL-H/E SN-IKZ-PM TICN-67
	10	1,5	100	16	7	5,5	9,35	.0100			
	12	1,75	110	18	9	7	11,25	.0112	●	●	●
	14	2	110	20	11	9	13,1	.0114			
	16	2	110	22	12	9	15,1	.0116	●	●	●
	18	2,5	125	25	14	11	16,85	.0118			
	20	2,5	140	25	16	12	18,85	.0120			
	22	2,5	140	27	18	14,5	20,85	.0122			
	24	3	160	30	18	14,5	22,6	.0124			
	27	3	160	30	20	16	25,6	.0127			
	30	3,5	180	35	22	18	28,35	.0130			
	33	3,5	180	35	25	20	31,35	.0133			
	36	4	200	40	28	22	34,1	.0136			
	39	4	200	40	32	24	37,1	.0139			
	42	4,5	200	45	32	24	39,85	.0142			
	45	4,5	220	45	36	29	42,85	.0145			
	48	5	250	50	36	29	45,65	.0148			

DIN 2174



» 279

» 279

» 280

1) Gewindeformen in Durchgangslöcher nur mit externer Kühlschmierung möglich
Cold-forming in through holes is possible only with external cooling/lubrication



















3) Zum Patent angemeldet
Patent pending



Bei schlecht ausformenden Werkstoffen (z.B. GAL) empfehlen wir bei P ≥ 1 mm um 0,05 mm kleiner vorzubohren.
Weitere Informationen zu den empfohlenen Vorfertigungsdurchmessern siehe Seite 321.

We recommend a smaller preparatory diameter by 0.05 mm for difficult to form materials (such as aluminium cast alloys) for P ≥ 1 mm.
For further information regarding the recommended preparatory diameters, see page 321.

- Product Finder
- V_c
- M
- MF
- UNC
- UNF
- G
- SELF-LOCK
- Tech. Info

H Materials of high tensile strength		Z CNC-controlled machines							
									
6HX	6HX	6HX	6HX	6HX	6HX	6HX	6HX	6HX	
TIN-T26	TIN-T26	TIN-80	TIN-80	TIN-80	TIN-80	TIN-80	TIN-80	TIN-80	
HSSE-PM	HSSE-PM	HSSE-PM	HSSE-PM	HSSE-PM	HSSE-PM	HSSE-PM	HSSE-PM	HSSE-PM	
C / 2-3	C / 2-3	C / 2-3	C / 2-3	C / 2-3	C / 2-3	C / 2-3	E / 1,5-2	E / 1,5-2	
E / O	E	E / O / P	E / O / P	E / O	E / O	E / O	E / O / P	E / O	
max. 3 x d ₁	max. 3 x d ₁	max. 3 x d ₁	max. 3 x d ₁	max. 3 x d ₁	max. 3 x d ₁	max. 3 x d ₁	max. 3 x d ₁	max. 3 x d ₁	
									
P 2.1-5.1	P 2.1-5.1	P 1.1-5.1	P 1.1-5.1	P 1.1-5.1	P 1.1-5.1	P 1.1-5.1	P 1.1-5.1	P 1.1-5.1	
K 2.1	K 2.1	M 1.1-3.1 ²⁾	M 1.1-3.1 ²⁾	M 1.1-3.1 ²⁾	M 1.1-3.1 ²⁾	M 1.1-3.1 ²⁾	M 1.1-3.1 ²⁾	M 1.1-3.1 ²⁾	
		K 2.1	K 2.1	K 2.1	K 2.1	K 2.1	K 2.1	K 2.1	
		N 2.1-2, 2.4-5	N 2.1-2, 2.4-5	N 2.1-2, 2.4-5	N 2.1-2, 2.4-5	N 2.1-2, 2.4-5	N 2.1-2, 2.4-5	N 2.1-2, 2.4-5	
		S 1.1-2.2 ²⁾	S 1.1-2.2 ²⁾	S 1.1-2.2 ²⁾	S 1.1-2.2 ²⁾	S 1.1-2.2 ²⁾	S 1.1-2.2 ²⁾	S 1.1-2.2 ²⁾	
		S 2.4 ²⁾	S 2.4 ²⁾	S 2.4 ²⁾	S 2.4 ²⁾	S 2.4 ²⁾	S 2.4 ²⁾	S 2.4 ²⁾	
C521W700	C523W700	C519Z700	C521Z700	C523Z700	C526Z700	C529Z700	C531Z700		
InnoForm 2-H-SN-PM TIN-T26	InnoForm 2-H-SN-PM PM-TIN-T26	InnoForm 2-Z-SN-PM TIN-80	InnoForm 2-Z-SN-PM TIN-80	InnoForm 2-Z-SN-PM PM-TIN-80	InnoForm 2-Z-SN-PM PM-TIN-80	InnoForm 2-Z-SN-PM PM-TIN-80	InnoForm 2-Z-SN-PM PM-TIN-80	InnoForm 2-Z-SN-PM PM-TIN-80	
●	●	●	●	●	○	●	●	●	M 10
		●	●	●	○	●	●	●	12
		●	●	●	○	●	●	●	14
									16
			●	●	○				18
									20
									22
									24
									27
									30
									33
									36
									39
									42
									45
									48
283	283	283	283	283	283	283	283	283	

²⁾ Mit Emulsion nur bedingt einsetzbar
Restricted application possibilities with emulsion

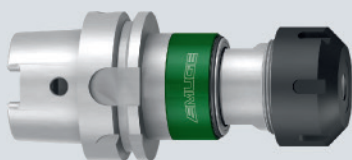

Werkzeug-Aufnahmen für
Minimalmengenschmierung
siehe Seite 714 - 732

Tool holders for
minimum-quantity lubrication,
see page 714 - 732

- Product Finder
- Vc
- M**
- MF
- UNC
- UNF
- G
- SELF-LOCK
- Tech. Info

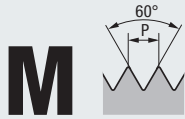

DIN 13

DIN 2174

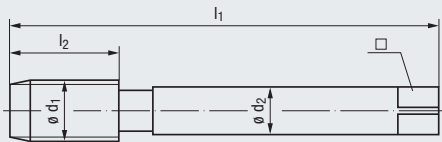

SPEED
High-speed cutting

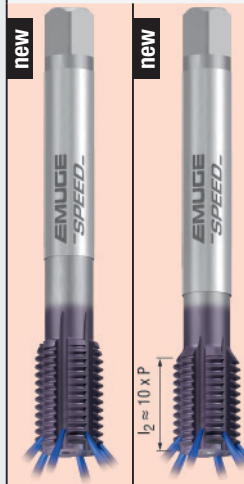

Technische Informationen
Technical information

305 - 324

Toleranz · Tolerance
Beschichtung · Coating
Schneidstoff · Cutting material



6HX	6HX
TICN	TICN
HSSE	VHM
E / 1,5-2	E / 1,5-2
E / 0	E / 0

Gewindetiefe und Lochform
Thread depth and hole type

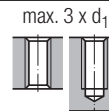

Einsatzgebiete – Material
Application – material

272

N 1.4-5 N 1.4-5

Werkzeug-Ident · Tool ident

C5059500 C505Q800

M	∅ d ₁ mm	P mm	l ₁	l ₂	∅ d ₂	□	Image	Dimens.- Ident	Drück	VHM-Drück
									2-GAL SPEED/E-SN IKZN-TICN	2-GAL SPEED/E-SN IKZN-TICN
	10	1,5	100	22	7	5,5	9,35	.0100		
	12	1,75	110	24	9	7	11,25	.0112	○	○
	14	2	110	26	11	9	13,1	.0114		
	16	2	110	27	12	9	15,1	.0116		
	18	2,5	125	30	14	11	16,85	.0118		
	20	2,5	140	32	16	12	18,85	.0120		

DIN 2174



285

285



Bei schlecht ausformenden Werkstoffen (z.B. GAL) empfehlen wir bei P ≥ 1 mm um 0,05 mm kleiner vorzubohren.
Weitere Informationen zu den empfohlenen Vorfertigungsdurchmessern siehe Seite 321.

We recommend a smaller preparatory diameter by 0.05 mm for difficult to form materials (such as aluminium cast alloys) for P ≥ 1 mm.
For further information regarding the recommended preparatory diameters, see page 321.

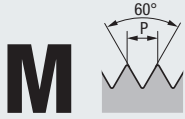

DIN 13

Mit extra langem Schaft
With extra long shank

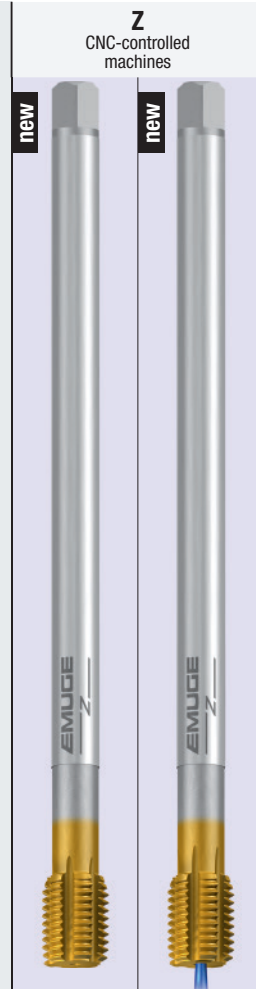
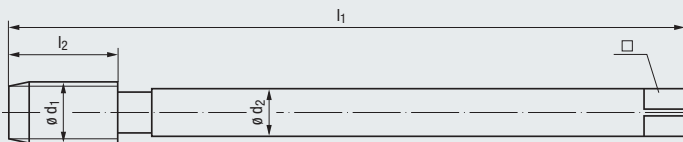

- Product Finder
- Vc
- M
- MF
- UNC
- UNF
- G
- SELF-LOCK
- Tech. Info

Technische Informationen Technical information	305 - 324	Toleranz · Tolerance Beschichtung · Coating Schneidstoff · Cutting material	6HX TIN-80 HSSE-PM	6HX TIN-80 HSSE-PM
			C / 2-3 E / O / P	C / 2-3 E / O
Gewindetiefe und Lochform Thread depth and hole type			max. 3 x d ₁ 	max. 3 x d ₁
Einsatzgebiete – Material Application – material	272		P 1.1-5.1 M 1.1-3.1 ²⁾ K 2.1 N 2.1-2, 2.4-5 S 1.1-2.2 ²⁾ S 2.4 ²⁾	P 1.1-5.1 M 1.1-3.1 ²⁾ K 2.1 N 2.1-2, 2.4-5 S 1.1-2.2 ²⁾ S 2.4 ²⁾

Werkzeug-Ident · Tool ident								C555Z700	C544Z700
Ø d ₁ mm	P mm	l ₁	l ₂	Ø d ₂	□		Dimens.-Ident	InnoForm 2-Z-SN-LS PM-TIN-80	InnoForm 2-Z-SN-IKZ LS-PM TIN-80
M 10	1,5	200	16	7	5,5	9,35	.0100		
12	1,75	224	18	9	7	11,25	.0112	●	○
14	2	224	20	11	9	13,1	.0114	○	○
16	2	224	22	12	9	15,1	.0116	●	○
18	2,5	250	25	14	11	16,85	.0118		
20	2,5	280	25	16	12	18,85	.0120	○	○

1) Gewindeformen in Durchgangslöchern nur mit externer Kühlschmierung möglich
Cold-forming in through holes is possible only with external cooling/lubrication

2) Mit Emulsion nur bedingt einsetzbar
Restricted application possibilities with emulsion

Bei schlecht ausformenden Werkstoffen (z.B. GAL) empfehlen wir bei P ≥ 1 mm um 0,05 mm kleiner vorzubohren.
Weitere Informationen zu den empfohlenen Vorfertigungsdurchmessern siehe Seite 321.

We recommend a smaller preparatory diameter by 0.05 mm for difficult to form materials (such as aluminium cast alloys) for P ≥ 1 mm.
For further information regarding the recommended preparatory diameters, see page 321.

- Product Finder
- Vc
- M**
- MF
- UNC
- UNF
- G
- SELF-LOCK
- Tech. Info

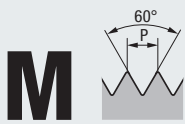

DIN 13

Für Gewindetiefen bis max. 3 x d₁
For thread depths up to max. 3 x d₁

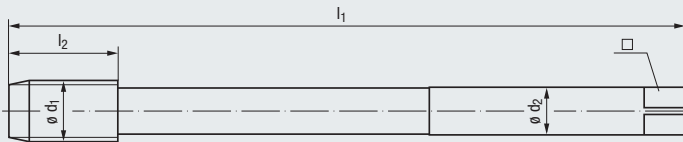

Technische Informationen
Technical information

» 305 - 324

Toleranz · Tolerance
Beschichtung · Coating
Schneidstoff · Cutting material



- | | |
|----------------|----------------|
| 6HX | 6HX |
| TIN-T26 | TIN-T26 |
| HSSE-PM | HSSE-PM |
| C / 2-3 | C / 2-3 |
| E / O | E / O |

Gewindetiefe und Lochform
Thread depth and hole type

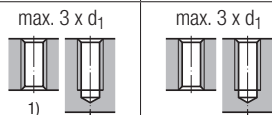

Einsatzgebiete – Material
Application – material

» 272

- | | |
|------------------|------------------|
| P 2.1-5.1 | P 2.1-5.1 |
| K 2.1 | K 2.1 |

Werkzeug-Ident · Tool ident

C599W700 C500W700

M	∅ d ₁ mm	P mm	l ₁	l ₂	∅ d ₂	□	Image of Tap	Dimens.- Ident	InnoForm 2-H-SN- IKZ LF3-PM TIN-T26	InnoForm 2-H-SN- IKZN LF3-PM TIN-T26
									○	○
	24	3	215	30	18	14,5	22,6	.0124	○	○
	30	3,5	240	35	22	18	28,35	.0130	○	○
	33	3,5	255	35	25	20	31,35	.0133	○	○
	36	4	275	40	28	22	34,1	.0136	○	○
	42	4,5	295	45	32	24	39,85	.0142	○	○

1) Gewindeformen in Durchgangslöcher nur mit externer Kühlschmierung möglich
Cold-forming in through holes is possible only with external cooling/lubrication



Bei schlecht ausformenden Werkstoffen (z.B. GAL) empfehlen wir bei P ≥ 1 mm um 0,05 mm kleiner vorzubohren.
Weitere Informationen zu den empfohlenen Vorfertigungsdurchmessern siehe Seite 321.

We recommend a smaller preparatory diameter by 0.05 mm for difficult to form materials (such as aluminium cast alloys) for P ≥ 1 mm.
For further information regarding the recommended preparatory diameters, see page 321.

M



DIN 13

Für Gewindetiefen bis max. 4 x d₁
For thread depths up to max. 4 x d₁

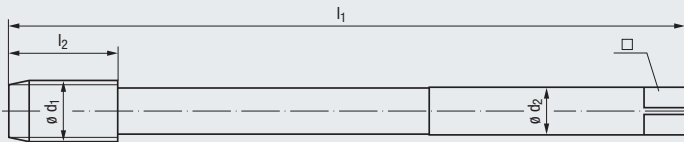

Technische Informationen Technical information ▶ 305 - 324	Toleranz · Tolerance Beschichtung · Coating Schneidstoff · Cutting material 	6HX TIN-T26 HSSE-PM	6HX TIN-T26 HSSE-PM
		C / 2-3 E / O	C / 2-3 E / O
Gewindetiefe und Lochform Thread depth and hole type	max. 4 x d ₁ 	max. 4 x d ₁ 	
Einsatzgebiete – Material Application – material ▶ 272	P 2.1-5.1 K 2.1	P 2.1-5.1 K 2.1	

Werkzeug-Ident · Tool ident								C594W700	C595W700
Ø d ₁ mm	P mm	l ₁	l ₂	Ø d ₂	□		Dimens.-Ident	InnoForm 2-H-SN- IKZ LF4-PM TIN-T26	InnoForm 2-H-SN- IKZN LF4-PM TIN-T26
M 24	3	240	30	18	14,5	22,6	.0124	○	○
30	3,5	270	35	22	18	28,35	.0130	○	○
33	3,5	290	35	25	20	31,35	.0133	○	○
36	4	310	40	28	22	34,1	.0136	○	○
42	4,5	340	45	32	24	39,85	.0142	○	○

1) Gewindeformen in Durchgangslöchern nur mit externer Kühlschmierung möglich
Cold-forming in through holes is possible only with external cooling/lubrication

Bei schlecht ausformenden Werkstoffen (z.B. GAL) empfehlen wir bei P ≥ 1 mm um 0,05 mm kleiner vorzubohren.
Weitere Informationen zu den empfohlenen Vorfertigungsdurchmessern siehe Seite 321.

We recommend a smaller preparatory diameter by 0.05 mm for difficult to form materials (such as aluminium cast alloys) for P ≥ 1 mm.
For further information regarding the recommended preparatory diameters, see page 321.

- Product Finder
- Vc
- M
- MF
- UNC
- UNF
- G
- SELF-LOCK
- Tech. Info



- Product Finder
- Vc
- M
- MF**
- UNC
- UNF
- G
- SELF-LOCK
- Tech. Info



DIN 13

DIN 2174

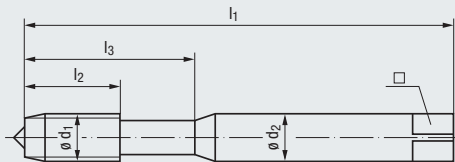

STEEL
Steel materials



Technische Informationen
Technical information

» 305 - 324

Toleranz · Tolerance
Beschichtung · Coating
Schneidstoff · Cutting material



6HX	6HX
TIN	TIN
HSSE	HSSE
C / 2-3	C / 2-3
E / O / P	E / O / P

Gewindetiefe und Lochform
Thread depth and hole type

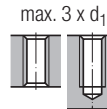

Einsatzgebiete – Material
Application – material

» 272

P 1.1-3.1	P 1.1-3.1
M 1.1-2.1 2)	M 1.1-2.1 2)
N 1.4-5, 2.1-2	N 1.4-5, 2.1-2

Werkzeug-Ident · Tool ident

B0911400 B0921400

M	ø d ₁ mm	P mm	l ₁	l ₂	l ₃	ø d ₂	□	Image	Dimens.- Ident	Drück	Drück
										1-STEEL TIN	1-STEEL-SN TIN
	2,5	x 0,35	50	7	12	2,8	2,1	2,37	.0196		
	2,6	x 0,35	50	7	12	2,8	2,1	2,47	.0199		
	3	x 0,35	56	8	18	3,5	2,7	2,88	.0202		
	3,5	x 0,35	56	9	20	4	3	3,38	.0205		
	4	x 0,5	63	10	21	4,5	3,4	3,8	.0210	•	•
	5	x 0,5	70	11	25	6	4,9	4,8	.0218	•	•
	6	x 0,5	80	13	30	6	4,9	5,8	.0228	•	•
	6	x 0,75	80	13	30	6	4,9	5,7	.0229	•	•
	7	x 0,75	80	13	30	7	5,5	6,7	.0239		
	8	x 0,75	80	14	30	8	6,2	7,7	.0250	•	•
	8	x 1	90	17	35	8	6,2	7,6	.0251	•	•
	9	x 0,75	90	14	35	9	7	8,7	.0262		
	9	x 1	90	17	35	9	7	8,6	.0263		
	10	x 0,75	90	15	35	10	8	9,7	.0275		
	10	x 1	90	18	35	10	8	9,6	.0276	•	•
	10	x 1,25	100	18	39	10	8	9,45	.0277		

DIN 2174



» 296

» 296

1) Gewindeformen in Durchgangslöcher nur mit externer Kühlschmierung möglich
Cold-forming in through holes is possible only with external cooling/lubrication

2) Mit Emulsion nur bedingt einsetzbar
Restricted application possibilities with emulsion



Bei schlecht ausformenden Werkstoffen (z.B. GAL) empfehlen wir bei P ≥ 1 mm um 0,05 mm kleiner vorzubohren.
Weitere Informationen zu den empfohlenen Vorfertigungsdurchmessern siehe Seite 321.

We recommend a smaller preparatory diameter by 0.05 mm for difficult to form materials (such as aluminium cast alloys) for P ≥ 1 mm.
For further information regarding the recommended preparatory diameters, see page 321.

MF



DIN 13

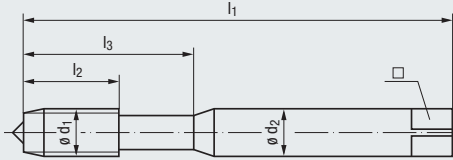

DIN 2174

Z
CNC-controlled machines

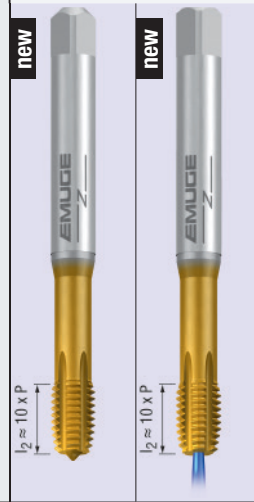

SPEED
High-speed cutting

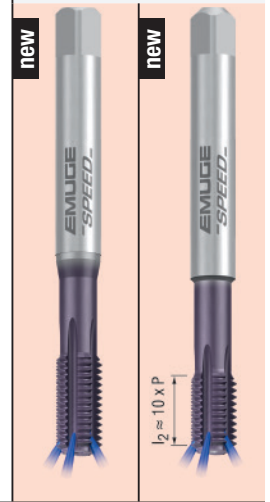

Technische Informationen
Technical information

» 305 - 324

Toleranz · Tolerance
Beschichtung · Coating
Schneidstoff · Cutting material



6HX	6HX
TIN-80	TIN-80
HSSE-PM	HSSE-PM
C / 2-3	C / 2-3
E / O / P	E / O

6HX	6HX
TICN	TICN
HSSE	VHM
E / 1,5-2	E / 1,5-2
E / O	E / O

Gewindetiefe und Lochform
Thread depth and hole type

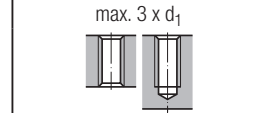
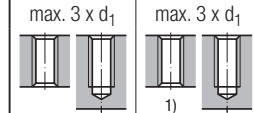

Einsatzgebiete – Material
Application – material

» 272

P 1.1-5.1	P 1.1-5.1
M 1.1-3.1 2)	M 1.1-3.1 2)
K 2.1	K 2.1
N 2.1-2, 2.4-5	N 2.1-2, 2.4-5
S 1.1-2.2 2)	S 1.1-2.2 2)
S 2.4 2)	S 2.4 2)

N 1.4-5	N 1.4-5
----------------	----------------

Werkzeug-Ident · Tool ident

B521Z700	B523Z700
InnoForm 1-Z-SN-PM TIN-80	InnoForm 1-Z-SN-IKZ PM-TIN-80

B5059500	B5050800
Drück 1-GAL SPEED/E-SN IKZN-TICN	VHM-Drück 1-GAL SPEED/E-SN IKZN-TICN

	ø d ₁ mm	P mm	l ₁	l ₂	l ₃	ø d ₂	□		Dimens.-Ident	InnoForm 1-Z-SN-PM TIN-80		InnoForm 1-Z-SN-IKZ PM-TIN-80		Drück 1-GAL SPEED/E-SN IKZN-TICN		VHM-Drück 1-GAL SPEED/E-SN IKZN-TICN	
										B521Z700	B523Z700	B5059500	B5050800				
M	2,5 x 0,35	50	7	12	2,8	2,1	2,37	.0196									
	2,6 x 0,35	50	7	12	2,8	2,1	2,47	.0199									
	3 x 0,35	56	8	18	3,5	2,7	2,88	.0202									
	3,5 x 0,35	56	9	20	4	3	3,38	.0205									
	4 x 0,5	63	10	21	4,5	3,4	3,8	.0210									
	5 x 0,5	70	11	25	6	4,9	4,8	.0218									
	6 x 0,5	80	13	30	6	4,9	5,8	.0228									
	6 x 0,75	80	13	30	6	4,9	5,7	.0229						○		○	
	7 x 0,75	80	13	30	7	5,5	6,7	.0239									
	8 x 0,75	80	14	30	8	6,2	7,7	.0250									
	8 x 1	90	17	35	8	6,2	7,6	.0251	●	●			○		○		
	9 x 0,75	90	14	35	9	7	8,7	.0262									
	9 x 1	90	17	35	9	7	8,6	.0263									
	10 x 0,75	90	15	35	10	8	9,7	.0275									
	10 x 1	90	18	35	10	8	9,6	.0276	●	●							
	10 x 1,25	100	18	39	10	8	9,45	.0277						○		○	

DIN 2174



» 297

» 297

» 298

» 298

1) Gewindeformen in Durchgangslöchern nur mit externer Kühlschmierung möglich
Cold-forming in through holes is possible only with external cooling/lubrication

2) Mit Emulsion nur bedingt einsetzbar
Restricted application possibilities with emulsion



Bei schlecht ausformenden Werkstoffen (z.B. GAL) empfehlen wir bei P ≥ 1 mm um 0,05 mm kleiner vorzubohren.

Weitere Informationen zu den empfohlenen Vorfertigungsdurchmessern siehe Seite 321.

We recommend a smaller preparatory diameter by 0.05 mm for difficult to form materials (such as aluminium cast alloys) for P ≥ 1 mm.

For further information regarding the recommended preparatory diameters, see page 321.

- Product Finder
- Vc
- M
- MF**
- UNC
- UNF
- G
- SELF-LOCK
- Tech. Info

MF



DIN 13

DIN 2174

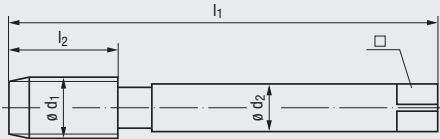

STEEL
Steel materials

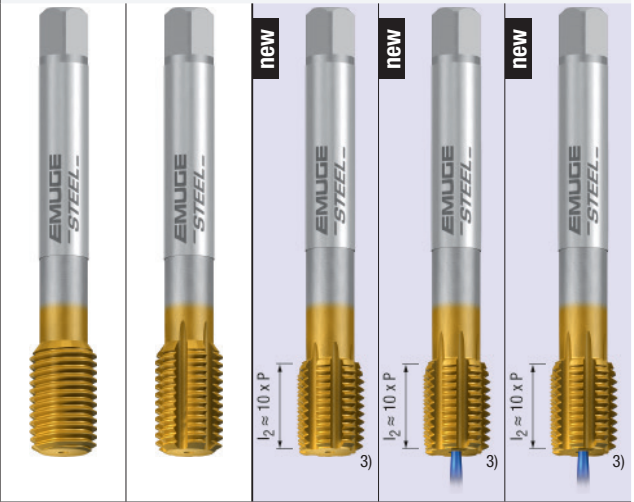

Toleranz · Tolerance
Beschichtung · Coating
Schneidstoff · Cutting material

Technische Informationen
Technical information

» 305 - 324



6HX	6HX	6HX	6HX	6HX
TIN	TIN	TIN-66	TIN-66	TIN-66
HSSE	HSSE	HSSE-PM	HSSE-PM	HSSE-PM
C / 2-3	C / 2-3	C / 2-3	C / 2-3	E / 1,5-2
E / O / P	E / O / P	E / O / P	E / O	E / O

Gewindetiefe und Lochform
Thread depth and hole type

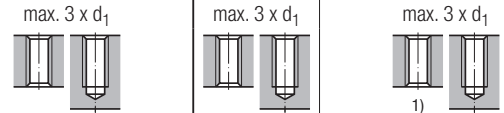

Einsatzgebiete – Material
Application – material

» 272

P 1.1-3.1	P 1.1-3.1	P 1.1-4.1	P 1.1-4.1	P 1.1-4.1
M 1.1-2.1 2)	M 1.1-2.1 2)	K 2.1	K 2.1	K 2.1
N 1.4-5, 2.1-2	N 1.4-5, 2.1-2			

Werkzeug-Ident · Tool ident

M	Ø d ₁ mm	P mm	l ₁	l ₂	Ø d ₂	□	Image	Dimens.- Ident	C0911400	C0921400	C5217F00	C5237F00	C5317F00
									Drück 2-STEEL TIN	Drück 2-STEEL-SN TIN	InnoForm 2-STEEL-M SN-PM TIN-66	InnoForm 2-STEEL-M SN-IKZ-PM TIN-66	InnoForm 2-STEEL-M/E SN-IKZ-PM TIN-66
11	x 1	90	18	8	6,2	10,6	.0288						
12	x 1	100	18	9	7	11,6	.0301	●	●				
12	x 1,25	100	22	9	7	11,45	.0302						
12	x 1,5	100	22	9	7	11,35	.0303	●	●	●	●	●	
14	x 1	100	18	11	9	13,6	.0329						
14	x 1,25	100	22	11	9	13,45	.0330						
14	x 1,5	100	22	11	9	13,35	.0331	●	●	●	●	●	
15	x 1	100	18	12	9	14,6	.0343						
15	x 1,5	100	22	12	9	14,35	.0345						
16	x 1	100	18	12	9	15,6	.0357	○	○				
16	x 1,5	100	22	12	9	15,35	.0359	●	●	●	●	●	
18	x 1	110	20	14	11	17,6	.0388						
18	x 1,5	110	25	14	11	17,35	.0390						
18	x 2	125	26	14	11	17,1	.0391						
20	x 1	125	20	16	12	19,6	.0420						
20	x 1,5	125	25	16	12	19,35	.0422	●	●				
20	x 2	140	27	16	12	19,1	.0423						

DIN 2174



» 294

» 294

1) Gewindeformen in Durchgangslöcher nur mit externer Kühlschmierung möglich
Cold-forming in through holes is possible only with external cooling/lubrication

2) Mit Emulsion nur bedingt einsetzbar
Restricted application possibilities with emulsion

3) Zum Patent angemeldet
Patent pending















Bei schlecht ausformenden Werkstoffen (z.B. GAL) empfehlen wir bei P ≥ 1 mm um 0,05 mm kleiner vorzubohren.

Weitere Informationen zu den empfohlenen Vorfertigungsdurchmessern siehe Seite 321.

We recommend a smaller preparatory diameter by 0.05 mm for difficult to form materials (such as aluminium cast alloys) for P ≥ 1 mm.

For further information regarding the recommended preparatory diameters, see page 321.

- Product Finder
- Vc
- M
- MF
- UNC
- UNF
- G
- SELF-LOCK
- Tech. Info

STEEL Steel materials			H Materials of high tensile strength		Z CNC-controlled machines		
							
new	new	new			new	new	
6HX	6HX	6HX	6HX	6HX	6HX	6HX	
TICN-67	TICN-67	TICN-67	TIN-T26	TIN-T26	TIN-80	TIN-80	
HSSE-PM	HSSE-PM	HSSE-PM	HSSE-PM	HSSE-PM	HSSE-PM	HSSE-PM	
C / 2-3	C / 2-3	E / 1,5-2	C / 2-3	C / 2-3	C / 2-3	C / 2-3	
E / O / P	E / O	E / O	E / O	E	E / O / P	E / O	
max. 3 x d ₁	max. 3 x d ₁		max. 3 x d ₁	max. 3 x d ₁	max. 3 x d ₁	max. 3 x d ₁	
							
P 3.1-5.1	P 3.1-5.1	P 3.1-5.1	P 2.1-5.1	P 2.1-5.1	P 1.1-5.1	P 1.1-5.1	
K 2.1	K 2.1	K 2.1	K 2.1	K 2.1	M 1.1-3.1 2)	M 1.1-3.1 2)	
					K 2.1	K 2.1	
					N 2.1-2, 2.4-5	N 2.1-2, 2.4-5	
					S 1.1-2.2 2)	S 1.1-2.2 2)	
					S 2.4 2)	S 2.4 2)	
C5216F00	C5236F00	C5316F00	C521W700	C523W700	C521Z700	C523Z700	
InnoForm 2-STEEL-H SN-PM TICN-67	InnoForm 2-STEEL-H SN-IKZ-PM TICN-67	InnoForm 2-STEEL-H/E SN-IKZ-PM TICN-67	InnoForm 2-H-SN-PM TIN-T26	InnoForm 2-H-SN-IKZ PM-TIN-T26	InnoForm 2-Z-SN-PM TIN-80	InnoForm 2-Z-SN-IKZ PM-TIN-80	
							M 11 x 1
							12 x 1
							12 x 1,25
●	●	●	●	●	●	●	12 x 1,5
							14 x 1
							14 x 1,25
●	●	●	●	●	●	●	14 x 1,5
							15 x 1
							15 x 1,5
●	●	●	●	●	●	●	16 x 1
							16 x 1,5
							18 x 1
							18 x 1,5
							18 x 2
							20 x 1
							20 x 1,5
							20 x 2
					295	295	



Kühlschmierstoffe siehe Seite 238 - 239

Coolant-lubricants, see page 238 - 239

● = Lagerwerkzeug, siehe Preisliste · Stock tool, see price list
○ = Kurzfristig lieferbar, Preis auf Anfrage · Available on short notice, price upon inquiry

- Product Finder
- V_c
- M
- MF**
- UNC
- UNF
- G
- SELF-LOCK
- Tech. Info



DIN 13

DIN 2174

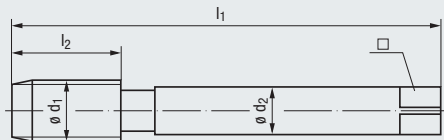

SPEED
High-speed cutting

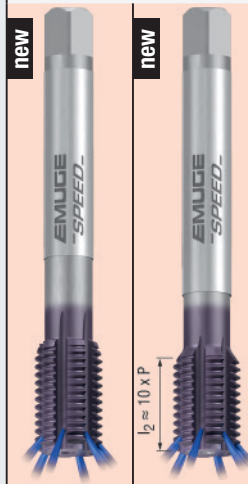

Technische Informationen
Technical information

305 - 324

Toleranz · Tolerance
Beschichtung · Coating
Schneidstoff · Cutting material



6HX	6HX
TICN	TICN
HSSE	VHM
E / 1,5-2	E / 1,5-2
E / 0	E / 0

Gewindetiefe und Lochform
Thread depth and hole type

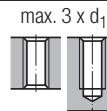

Einsatzgebiete – Material
Application – material

272

N 1.4-5 N 1.4-5

Werkzeug-Ident · Tool ident

C5059500 C505Q800

M	Ø d ₁ mm	P mm	l ₁	l ₂	Ø d ₂	□	Image	Dimens.- Ident	Drück	VHM-Drück
									2-GAL SPEED/E-SN IKZN-TICN	2-GAL SPEED/E-SN IKZN-TICN
	11	x 1	90	18	8	6,2		.0288		
	12	x 1	100	18	9	7		.0301		
	12	x 1,25	100	22	9	7		.0302	○	○
	12	x 1,5	100	22	9	7		.0303	○	○
	14	x 1	100	18	11	9		.0329		
	14	x 1,25	100	22	11	9		.0330		
	14	x 1,5	100	22	11	9		.0331	○	○
	15	x 1	100	18	12	9		.0343		
	15	x 1,5	100	22	12	9		.0345		
	16	x 1	100	18	12	9		.0357		
	16	x 1,5	100	22	12	9		.0359	○	○
	18	x 1	110	20	14	11		.0388		
	18	x 1,5	110	25	14	11		.0390		
	18	x 2	125	26	14	11		.0391		
	20	x 1	125	20	16	12		.0420		
	20	x 1,5	125	25	16	12		.0422		
	20	x 2	140	27	16	12		.0423		

DIN 2174



295

295



Bei schlecht ausformenden Werkstoffen (z.B. GAL) empfehlen wir bei P ≥ 1 mm um 0,05 mm kleiner vorzubohren.

Weitere Informationen zu den empfohlenen Vorfertigungsdurchmessern siehe Seite 321.

We recommend a smaller preparatory diameter by 0.05 mm for difficult to form materials (such as aluminium cast alloys) for P ≥ 1 mm.

For further information regarding the recommended preparatory diameters, see page 321.

UNC

ASME B1.1

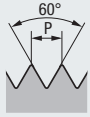

≈ DIN 2174

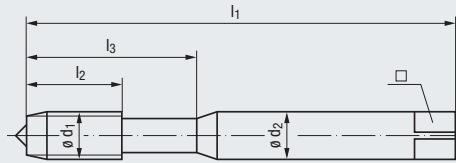

Technische Informationen
Technical information

» 305 - 324

Toleranz · Tolerance
Beschichtung · Coating
Schneidstoff · Cutting material



Gewindetiefe und Lochform
Thread depth and hole type

Einsatzgebiete – Material
Application – material

» 272

Werkzeug-Ident · Tool ident

ø d ₁ inch	P Gg/1" (tpi)	l ₁	l ₂	l ₃	ø d ₂	□	Image	Dimens.- Ident	STEEL Steel materials		Z CNC-controlled machines		
									Drück 1-STEEL TIN	Drück 1-STEEL-SN TIN	B521Z700 InnoForm 1-Z-SN-PM TIN-80	B523Z700 InnoForm 1-Z-SN- PM-TIN-80	
Nr. 4	0.1120	40	56	11	18	3,5	2,7	2,55	.5003	●	●	●	●
Nr. 5	0.1250	40	56	11	18	3,5	2,7	2,9	.5004	●	●	●	●
Nr. 6	0.1380	32	56	12	20	4	3	3,15	.5005	●	●	●	●
Nr. 8	0.1640	32	63	13	21	4,5	3,4	3,8	.5006	●	●	●	●
Nr. 10	0.1900	24	70	15	25	6	4,9	4,35	.5007	●	●	●	●
Nr. 12	0.2160	24	80	16	30	6	4,9	5	.5008	●	●	●	●
1/4	0.2500	20	80	17	30	7	5,5	5,75	.5009	●	●	●	●
5/16	0.3125	18	90	20	35	8	6,2	7,3	.5010	●	●	●	●
3/8	0.3750	16	100	22	39	10	8	8,8	.5011	●	●	●	●

≈ DIN 2174



» 300

» 300

» 300

» 300

1) Gewindeformen in Durchgangslöchern nur mit externer Kühlschmierung möglich
Cold-forming in through holes is possible only with external cooling/lubrication

2) Mit Emulsion nur bedingt einsetzbar
Restricted application possibilities with emulsion



Bei schlecht ausformenden Werkstoffen (z.B. GAL) empfehlen wir bei P = 24 Gg./1" und größer um 0,05 mm kleiner vorzubohren.

Weitere Informationen zu den empfohlenen Vorfertigungsdurchmessern siehe Seite 321.

We recommend a smaller preparatory diameter by 0.05 mm for difficult to form materials (such as aluminium cast alloys) for P = 24 threads/1" and coarser threads.

For further information regarding the recommended preparatory diameters, see page 321.



- Product Finder
- V_c
- M
- MF
- UNC**
- UNF
- G
- SELF-LOCK
- Tech. Info

UNC

ASME B1.1

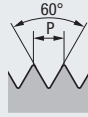

≈ DIN 2174

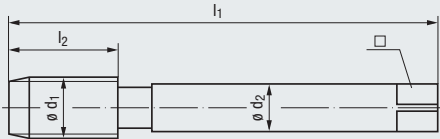

STEEL
Steel materials



Z
CNC-controlled machines

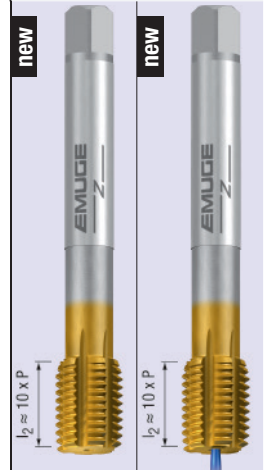

Technische Informationen
Technical information

305 - 324

Toleranz · Tolerance
Beschichtung · Coating
Schneidstoff · Cutting material



2BX	2BX
TIN	TIN
HSSE	HSSE
C / 2-3	C / 2-3
E / O / P	E / O / P

2BX	2BX
TIN-80	TIN-80
HSSE-PM	HSSE-PM
C / 2-3	C / 2-3
E / O / P	E / O

Gewindetiefe und Lochform
Thread depth and hole type



Einsatzgebiete – Material
Application – material

272

P 1.1-3.1	P 1.1-3.1	P 1.1-5.1	P 1.1-5.1
M 1.1-2.1 2)	M 1.1-2.1 2)	M 1.1-3.1 2)	M 1.1-3.1 2)
N 1.4-5, 2.1-2	N 1.4-5, 2.1-2	K 2.1	K 2.1
		N 2.1-2, 2.4-5	N 2.1-2, 2.4-5
		S 1.1-2.2 2)	S 1.1-2.2 2)
		S 2.4 2)	S 2.4 2)

Werkzeug-Ident · Tool ident

Werkzeug-Ident · Tool ident									C0911400	C0921400	C521Z700	C523Z700
Ø d ₁ inch	P Gg/1" (tpi)	l ₁	l ₂	Ø d ₂	□		Dimens.-Ident	Drück 2-STEEL TIN	Drück 2-STEEL-SN TIN	InnoForm 2-Z-SN-PM TIN-80	InnoForm 2-Z-SN-PM-TIN-80	
7/16	0.4375	14	100	22	8	6,2	10,25	.5012	●	●	●	●
1/2	0.5000	13	110	25	9	7	11,8	.5013	●	●	●	●
9/16	0.5625	12	110	26	11	9	13,3	.5014	○	○		
5/8	0.6250	11	110	27	12	9	14,8	.5015	●	●	●	●
3/4	0.7500	10	125	30	14	11	17,85	.5016	●	●	●	●
7/8	0.8750	9	140	32	18	14,5	20,9	.5017				
1"	1.0000	8	160	36	18	14,5	23,9	.5018				

≈ DIN 2174



299

299

299

299

1) Gewindeformen in Durchgangslöcher nur mit externer Kühlschmierung möglich
Cold-forming in through holes is possible only with external cooling/lubrication

2) Mit Emulsion nur bedingt einsetzbar
Restricted application possibilities with emulsion



Bei schlecht ausformenden Werkstoffen (z.B. GAL) empfehlen wir bei P = 24 Gg./1" und größer um 0,05 mm kleiner vorzubohren.
Weitere Informationen zu den empfohlenen Vorfertigungsdurchmessern siehe Seite 321.

We recommend a smaller preparatory diameter by 0.05 mm for difficult to form materials (such as aluminium cast alloys) for P = 24 threads/1" and coarser threads.
For further information regarding the recommended preparatory diameters, see page 321.

UNF



ASME B1.1

≈ DIN 2174

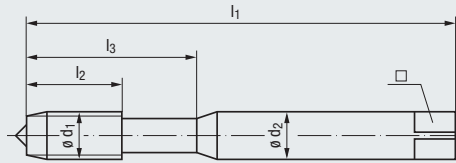

Technische Informationen
Technical information

» 305 - 324

Toleranz · Tolerance
Beschichtung · Coating
Schneidstoff · Cutting material



Gewindetiefe und Lochform
Thread depth and hole type

Einsatzgebiete – Material
Application – material

» 272

Werkzeug-Ident · Tool ident

Nr.	Ø d ₁ inch	P Gg/1" (tpi)	l ₁	l ₂	l ₃	Ø d ₂	□	Ø	Dimens.- Ident	STEEL Steel materials		Z CNC-controlled machines	
										Drück 1-STEEL TIN	Drück 1-STEEL-SN TIN	B521Z700 InnoForm 1-Z-SN-PM TIN-80	B523Z700 InnoForm 1-Z-SN- PM-TIN-80
Nr. 2	0.0860	64	45	7	12	2,8	2,1	2,02	.5035				
Nr. 3	0.0990	56	50	9	14	2,8	2,1	2,32	.5036				
Nr. 4	0.1120	48	56	11	18	3,5	2,7	2,62	.5037	●	●		
Nr. 5	0.1250	44	56	11	18	3,5	2,7	2,92	.5038				
Nr. 6	0.1380	40	56	12	20	4	3	3,22	.5039	●	●	●	
Nr. 8	0.1640	36	63	13	21	4,5	3,4	3,85	.5040	●	●	●	
Nr. 10	0.1900	32	70	15	25	6	4,9	4,45	.5041	●	●	●	●
Nr. 12	0.2160	28	80	16	30	6	4,9	5,1	.5042	●	●	●	●
1/4	0.2500	28	80	17	30	7	5,5	5,95	.5043	●	●	●	●
5/16	0.3125	24	90	17	35	8	6,2	7,45	.5044	●	●	●	●
3/8	0.3750	24	90	18	35	10	8	9,05	.5045	●	●	●	●
≈ DIN 2174										» 302	» 302	» 302	» 302

1) Gewindeformen in Durchgangslöcher nur mit externer Kühlschmierung möglich
Cold-forming in through holes is possible only with external cooling/lubrication

2) Mit Emulsion nur bedingt einsetzbar
Restricted application possibilities with emulsion



Bei schlecht ausformenden Werkstoffen (z.B. GAL) empfehlen wir bei P = 24 Gg./1" und größer um 0,05 mm kleiner vorzubohren.

Weitere Informationen zu den empfohlenen Vorfertigungsdurchmessern siehe Seite 321.

We recommend a smaller preparatory diameter by 0.05 mm for difficult to form materials (such as aluminium cast alloys) for P = 24 threads/1" and coarser threads.

For further information regarding the recommended preparatory diameters, see page 321.

Product Finder

- Vc
- M
- MF
- UNC
- UNF**
- G
- SELF-LOCK
- Tech. Info



- Product Finder
- V_c
- M
- MF
- UNC
- UNF**
- G
- SELF-LOCK
- Tech. Info

UNF

ASME B1.1



≈ DIN 2174

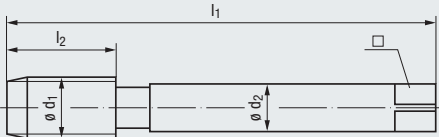

STEEL
Steel materials



Z
CNC-controlled machines

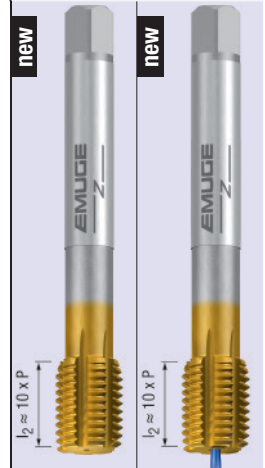

Technische Informationen
Technical information

305 - 324

Toleranz · Tolerance
Beschichtung · Coating
Schneidstoff · Cutting material



2BX	2BX	2BX	2BX
TIN	TIN	TIN-80	TIN-80
HSSE	HSSE	HSSE-PM	HSSE-PM
C / 2-3	C / 2-3	C / 2-3	C / 2-3
E / O / P	E / O / P	E / O / P	E / O

Gewindetiefe und Lochform
Thread depth and hole type



Einsatzgebiete – Material
Application – material

272

P 1.1-3.1	P 1.1-3.1	P 1.1-5.1	P 1.1-5.1
M 1.1-2.1 2)	M 1.1-2.1 2)	M 1.1-3.1 2)	M 1.1-3.1 2)
N 1.4-5, 2.1-2	N 1.4-5, 2.1-2	K 2.1	K 2.1
		N 2.1-2, 2.4-5	N 2.1-2, 2.4-5
		S 1.1-2.2 2)	S 1.1-2.2 2)
		S 2.4 2)	S 2.4 2)

Werkzeug-Ident · Tool ident

Werkzeug-Ident · Tool ident									C0911400	C0921400	C521Z700	C523Z700
Ø d ₁ inch	P Gg/1" (tpi)	l ₁	l ₂	Ø d ₂	□		Dimens.-Ident	Drück 2-STEEL TIN	Drück 2-STEEL-SN TIN	InnoForm 2-Z-SN-PM TIN-80	InnoForm 2-Z-SN-IKZ PM-TIN-80	
7/16	0.4375	20	100	22	8	6,2	10,55	.5046	●	●	●	
1/2	0.5000	20	100	22	9	7	12,15	.5047	●	●	●	
9/16	0.5625	18	100	22	11	9	13,65	.5048	○	○	○	
5/8	0.6250	18	100	22	12	9	15,25	.5049	●	●		
3/4	0.7500	16	110	25	14	11	18,35	.5050	●	●		
7/8	0.8750	14	125	25	18	14,5	21,4	.5051				
1"	1.0000	12	140	28	18	14,5	24,45	.5052				

≈ DIN 2174



301

301

301

301

1) Gewindeformen in Durchgangslöcher nur mit externer Kühlschmierung möglich
Cold-forming in through holes is possible only with external cooling/lubrication

2) Mit Emulsion nur bedingt einsetzbar
Restricted application possibilities with emulsion



Bei schlecht ausformenden Werkstoffen (z.B. GAL) empfehlen wir bei P = 24 Gg./1" und größer um 0,05 mm kleiner vorzubohren.
Weitere Informationen zu den empfohlenen Vorfertigungsdurchmessern siehe Seite 321.

We recommend a smaller preparatory diameter by 0.05 mm for difficult to form materials (such as aluminium cast alloys) for P = 24 threads/1" and coarser threads.
For further information regarding the recommended preparatory diameters, see page 321.

G (BSP)

DIN EN ISO 228

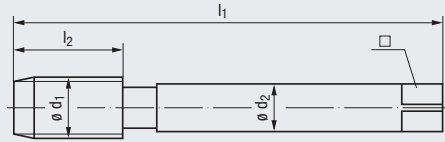
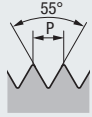

DIN 2189

STEEL
Steel materials



Z
CNC-controlled machines

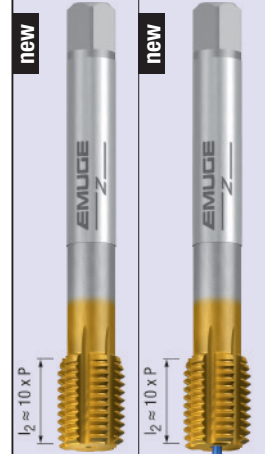

Technische Informationen
Technical information

» 305 - 324

Toleranz · Tolerance
Beschichtung · Coating
Schneidstoff · Cutting material



„X“	„X“	„X“	„X“
TIN	TIN	TIN-80	TIN-80
HSSE	HSSE	HSSE-PM	HSSE-PM
C / 2-3	C / 2-3	C / 2-3	C / 2-3
E / O / P	E / O / P	E / O / P	E / O

Gewindetiefe und Lochform
Thread depth and hole type



Einsatzgebiete – Material
Application – material

» 272

P 1.1-3.1	P 1.1-3.1	P 1.1-5.1	P 1.1-5.1
M 1.1-2.1 2)	M 1.1-2.1 2)	M 1.1-3.1 2)	M 1.1-3.1 2)
N 1.4-5, 2.1-2	N 1.4-5, 2.1-2	K 2.1	K 2.1
		N 2.1-2, 2.4-5	N 2.1-2, 2.4-5
		S 1.1-2.2 2)	S 1.1-2.2 2)
		S 2.4 2)	S 2.4 2)

Werkzeug-Ident · Tool ident

C0911400 C0921400 C521Z700 C523Z700

Nenngröße Nom. size	Ø d ₁ mm	P Gg/1" (tpi)	l ₁	l ₂	Ø d ₂	□	Ø	Dimens.- Ident	Drück		InnoForm	
									2-STEEL TIN	2-STEEL-SN TIN	2-Z-SN-PM TIN-80	2-Z-SN-PM TIN-80
G 1/16	7,72	28	90	17	6	4,9	7,25	.4034	●	●	●	●
1/8	9,73	28	90	18	7	5,5	9,25	.4035	●	●	●	●
1/4	13,16	19	100	22	11	9	12,55	.4036	●	●	●	●
3/8	16,66	19	100	22	12	9	16,05	.4037	●	●	●	●
1/2	20,96	14	125	25	16	12	20,1	.4038	●	●	●	●
5/8	22,91	14	125	25	18	14,5	22,05	.4039				
3/4	26,44	14	140	28	20	16	25,6	.4040		○		
7/8	30,20	14	150	28	22	18	29,35	.4041				
1"	33,25	11	160	30	25	20	32,15	.4042		○		

1) Gewindeformen in Durchgangslöchern nur mit externer Kühlschmierung möglich
Cold-forming in through holes is possible only with external cooling/lubrication

2) Mit Emulsion nur bedingt einsetzbar
Restricted application possibilities with emulsion



Bei schlecht ausformenden Werkstoffen (z.B. GAL) empfehlen wir bei P = 24 Gg./1" und größer um 0,05 mm kleiner vorzubohren.

Weitere Informationen zu den empfohlenen Vorfertigungsdurchmessern siehe Seite 321.

We recommend a smaller preparatory diameter by 0.05 mm for difficult to form materials (such as aluminium cast alloys) for P = 24 threads/1" and coarser threads.

For further information regarding the recommended preparatory diameters, see page 321.

Product Finder

Vc

M

MF

UNC

UNF

G

SELF-LOCK

Tech. Info



- Product Finder
- V_c
- M
- MF
- UNC
- UNF
- G
- SELF-LOCK**
- Tech. Info

LK-M

EMUGE-Norm · EMUGE Standard

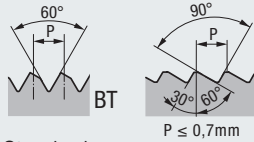

DIN 2174

STEEL
Steel materials

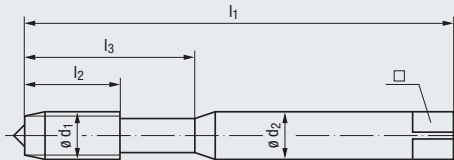

Technische Informationen
Technical information

» 305 - 324

Toleranz · Tolerance
Beschichtung · Coating
Schneidstoff · Cutting material



TIN	TIN
HSSE	HSSE
C / 2-3	C / 2-3
E / O / P	E / O / P

Gewindetiefe und Lochform
Thread depth and hole type

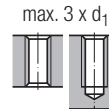

Einsatzgebiete – Material
Application – material

» 272

P 1.1-3.1	P 1.1-3.1
M 1.1-2.1 ²⁾	M 1.1-2.1 ²⁾
N 1.4-5, 2.1-2	N 1.4-5, 2.1-2

Werkzeug-Ident · Tool ident

B0911400 B0921400

Ø d ₁ mm	P mm	l ₁	l ₂	l ₃	Ø d ₂	□	Image	Dimens.- Ident	Drück	
									1-STEEL TIN	1-STEEL-SN TIN
LK-M 3	0,5	56	11	18	3,5	2,7	2,85	.1046	●	●
4	0,7	63	13	21	4,5	3,4	3,8	.1048	●	●
5	0,8	70	15	25	6	4,9	4,8	.1050	●	●
6	1	80	17	30	6	4,9	5,7	.1052	●	●
8	1,25	90	20	35	8	6,2	7,6	.1054	●	●
10	1,5	100	22	39	10	8	9,5	.1056	●	●

²⁾ Mit Emulsion nur bedingt einsetzbar
Restricted application possibilities with emulsion

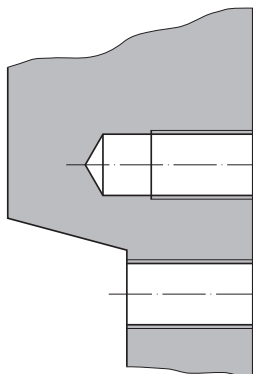

Ausführung BT
Type BT

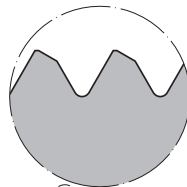

BT = Keilfläche nach hinten geneigt
BT = Wedge ramp inclined backwards



Bei schlecht ausformenden Werkstoffen (z.B. GAL) empfehlen wir bei P ≥ 1 mm um 0,05 mm kleiner vorzubohren.
Weitere Informationen zu den empfohlenen Vorfertigungsdurchmessern siehe Seite 321.

We recommend a smaller preparatory diameter by 0.05 mm for difficult to form materials (such as aluminium cast alloys) for P ≥ 1 mm.
For further information regarding the recommended preparatory diameters, see page 321.

Technische Informationen

Technical Information

Seite · Page

2.1	EMUGE Gewindeformer-Bauformen Constructional designs of our EMUGE cold-forming taps	306
2.2	Gewindeformer-Sonderausführungen (Beispiele) Special cold-forming tap types (examples)	307
2.3	EMUGE Gewindeformer-Grundformen Basic types of our EMUGE cold-forming taps	308
2.4	EMUGE Geometriebezeichnungen Our EMUGE geometries	308 - 309
2.5	EMUGE Oberflächenbehandlungen und -Beschichtungen Our EMUGE surface treatments and coatings	310
2.6	Sonstige EMUGE-Kurzbezeichnungen Other EMUGE abbreviations	311
2.7	Anformkegelformen Lead taper forms	312
2.8	Kühl- und Schmierstoffe Cooling and lubrication agents	313
2.9	Toleranzfelder des Flankendurchmessers beim Metrischen Gewinde (schematische Darstellung) Tolerance zones of the pitch diameter on the Metric thread (graphic representation)	314
2.10	Toleranzfelder des Flankendurchmessers beim Unified-Gewinde (schematische Darstellung) Tolerance zones of the pitch diameter on the Unified thread (graphic representation)	315
2.11	Schematischer Drehmomentverlauf beim Gewindeformen Schematic of torque curve in the cold forming of threads	316
2.12	Umformverhalten und Drehmoment Cold forming and torque	317
2.13	Das Fertigungsverfahren Gewindeformen Cold forming as a production process	318
2.14	Der Unterschied zwischen spanend hergestelltem und geformtem Innengewinde The difference between a cut thread and a cold-formed thread	319
2.15	Gewindekernloch-Vorfertigungsdurchmesser für Gewindeformer Thread hole preparatory diameters for cold-forming taps	320 - 321
2.16	Lehrung und Toleranzen geformter Innengewinde Gauging and tolerances of cold-formed threads	322
2.17	Technischer Fragebogen: Gewindeformen Technical questionnaire: Cold forming of threads	323 - 324

Product
FinderV_c

M

MF

UNC

UNF

G

SELF-LOCK

Tech. Info



Die Technischen Informationen der jeweiligen Kapitel dieses Kataloges sind in vielen Landessprachen auch als separate Druckerzeugnisse verfügbar. Bitte wenden Sie sich an den für Sie zuständigen Vertriebspartner.

The technical information complementing the various chapters of this catalogue is available also as a separate printed booklet in many different languages. Please speak to your usual sales contact.

- Product Finder
- V_c
- M
- MF
- UNC
- UNF
- G
- SELF-LOCK
- Tech. Info

2.1 EMUGE Gewindeformer-Bauformen

Bauformen nach DIN (Beispiele)

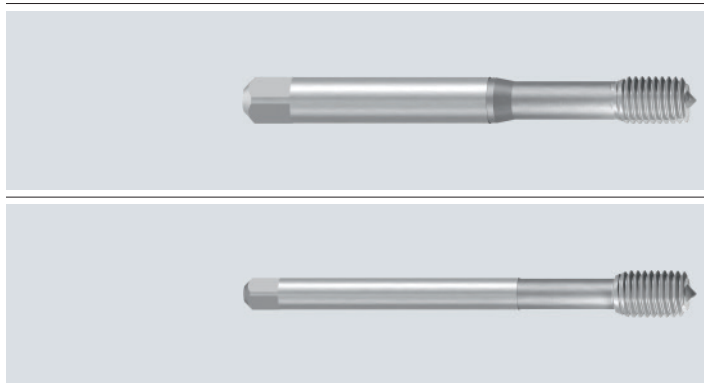

2.1 Constructional designs of our EMUGE cold-forming taps

Constructional designs acc. DIN (examples)

Bauform Constructional design	Baumaße Dimensions	EMUGE-Bezeichnung EMUGE designation
Maschinen-Gewindeformer mit verstärktem Schaft Machine cold-forming taps with reinforced shank	DIN 2174	Drück 1 InnoForm 1
Maschinen-Gewindeformer mit durchfallendem Schaft Machine cold-forming taps with reduced shank	DIN 2174	Drück 2 InnoForm 2

Bauformen nach EMUGE-Werknorm (Beispiele)

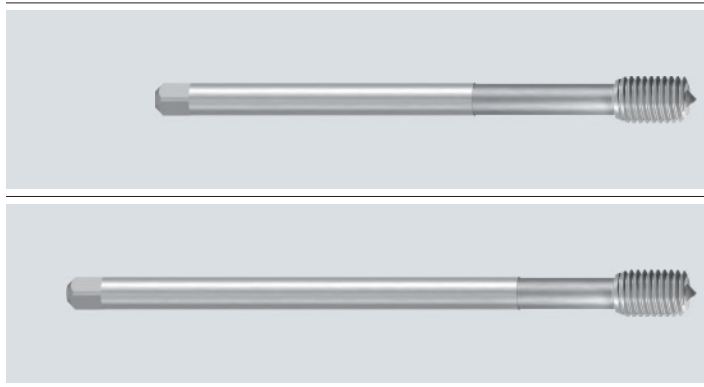

Constructional designs acc. EMUGE standard (examples)

Bauform Constructional design	EMUGE-Bezeichnung EMUGE designation
Maschinen-Gewindeformer mit langem Schaft Machine cold-forming taps with long shank	LF
Maschinen-Gewindeformer mit extra langem Schaft Machine cold-forming taps with extra long shank	LS



Geometrischer Aufbau eines Gewindeformers

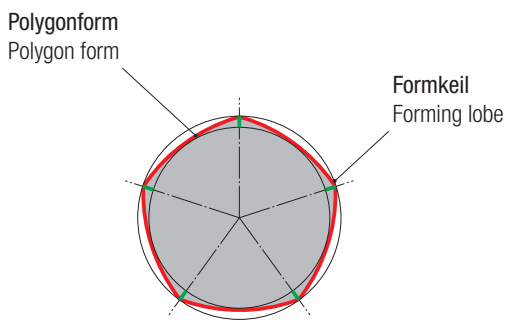

Geometric construction of a cold-forming tap

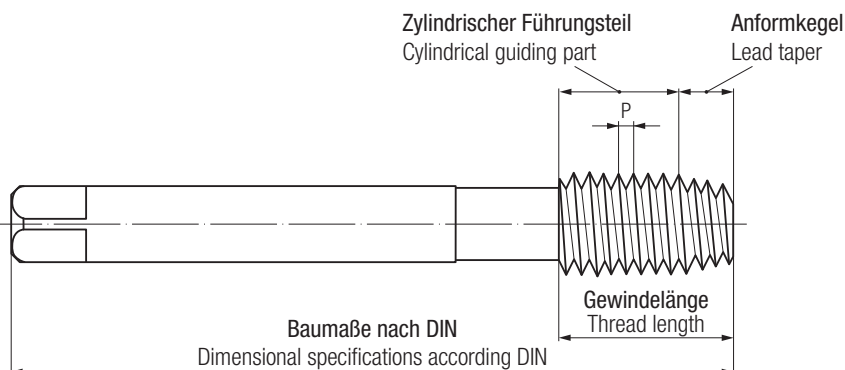
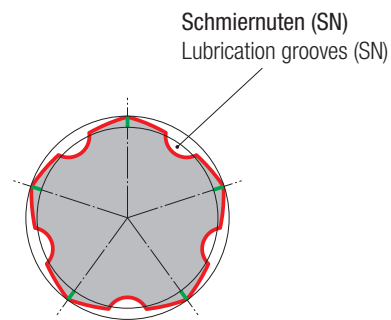

2.2 Gewindeformer-Sonderausführungen (Beispiele)

Sonderwerkzeuge nach Kundenwunsch

EMUGE fertigt Spezial-Gewindeformer nach Kundenzeichnungen und eigenen Konstruktionen.

InnoForm-Sonderwerkzeuge

Sollte für spezielle Anwendungsfälle im umfangreichen InnoForm-Gewindeformer-Programm keine geeignete Werkzeugvariante vorhanden sein, so werden kundenspezifisch, nach Angabe der Randbedingungen und der Werkstückzeichnung, InnoForm-Werkzeuge geliefert. Beispielsweise können spezielle Gewindeabmessungen und -toleranzen, Sondergewindeprofile, Sonderbauformen und besondere Verfahren zum kombinierten Gewindebohren und -formen bei der Konzeption beachtet werden.

2.2 Special cold-forming tap types (examples)

Special taps to customers' specifications

EMUGE produces special cold-forming taps to customers' drawings and proper specifications.

InnoForm special tools

If our comprehensive InnoForm programme of cold-forming taps does not include a suitable tool design for a specific application, we will be happy to furnish a custom-made, special InnoForm tool designed for the work conditions and according to the workpiece drawing of the individual customer. Such special designs can be made in special thread sizes and tolerances, with special thread profiles and dimensional specifications, or for special processes involving combined thread cutting and cold forming.

Product
FinderV_c

M

MF

UNC

UNF

G

SELF-LOCK

Tech. Info

Sondergewinde (Beispiele)

Special threads (examples)

FG

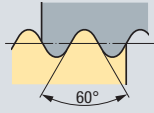

Fahradgewinde
nach DIN 79012
Bicycle thread
acc. DIN 79012

Vg

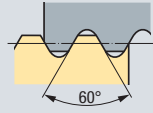

Ventilgewinde
nach DIN 7756
Valve thread
acc. DIN 7756

MFS

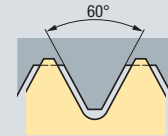

Metrisches ISO-Gewinde für Festsitz
nach DIN 8141-1
ISO Metric thread for tight fit
acc. DIN 8141-1

ST



Blechsraubengewinde
nach DIN EN ISO 1478
Sheet metal screw thread
acc. DIN EN ISO 1478

A/B

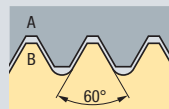

Stativ-Anschlussgewinde
nach DIN 4503
Tripod connection thread
acc. DIN 4503



- Product Finder
- V_c
- M
- MF
- UNC
- UNF
- G
- SELF-LOCK
- Tech. Info

2.3 EMUGE Gewindeformer-Grundformen

EMUGE stellte als weltweit erstes Unternehmen eine Reihe von Gewindeformern vor, die zur Bearbeitung von bestimmten Werkstoffen oder Werkstoffgruppen optimiert sind. War dies nur bei Schneidwerkzeugen möglich, so ist es EMUGE gelungen, Gewindeformer auf die Besonderheiten einzelner Werkstoffe und Werkstoffgruppen abzustimmen und dadurch die Leistung dieser Werkzeuge zum Teil deutlich zu erhöhen. Bis dahin waren Gewindeformer für den Einsatz in sämtlichen verformbaren Werkstoffen ausgelegt, wodurch in definierten Anwendungen Leistungspotential verschenkt wurde. EMUGE hat in mehrjähriger Entwicklungsarbeit die Mechanismen des Gewindeformens in bestimmten Werkstoffen untersucht und aus den erzielten Ergebnissen eine vollkommen neue Werkzeuggeneration geschaffen. Um dieses innovative Gewindeformer-Programm herauszuheben, wurde ein neuer Name gewählt: **InnoForm**

2.3 Basic types of our EMUGE cold-forming taps

EMUGE is the first threading tool manufacturer worldwide to introduce a programme of cold-forming taps specially designed for the machining of specific materials or material groups. While this was possible only for cutting tools, we have succeeded in designing cold-forming taps especially for the special properties of single materials and material groups, sometimes increasing performance in a dramatic way. Until then conventional cold-forming taps were made for the use in all ductile materials: potential performance features in defined applications were simply wasted in the process. EMUGE has made extensive investigations into the mechanisms of cold forming for years, and developed an entirely new tool generation from the results. In order to highlight the uniqueness of this highly innovative programme of cold-forming taps, we have thought of a new name: **InnoForm**

Drück



- Gewindeformer zur spanlosen Innengewinde-Herstellung
- Anformkegelform E (1,5-2 Gänge)
- Anformkegelform C (2-3 Gänge)
- Anformkegelform D (4-5 Gänge)
- Für Grundloch- und Durchgangslochgewinde

Bemerkung:

Abhängig vom zu bearbeitenden Material sind die wesentlichen Vorteile des Gewindeformens neben sehr guter Oberflächenqualität auch höhere statische und dynamische Festigkeit des Gewindes.

Die zu erzeugende Gewindelänge wird nicht durch abzuführende Späne begrenzt. Hervorragende Stabilität des Werkzeuges besonders bei kleinen Gewindeabmessungen. Sämtliche fließfähigen Werkstoffe können geformt werden. Auf ausreichende Schmierung muss geachtet werden. Schmiernuten werden grundsätzlich bei Durchgangslochgewinde und horizontaler Bearbeitung empfohlen (Ausnahme bei sehr kurzen Durchgangslochgewinden, wie z.B. bei Blechdurchzügen).

- Cold-forming tap for the chipless production of internal threads
- Lead taper form E (1.5-2 threads)
- Lead taper form C (2-3 threads)
- Lead taper form D (4-5 threads)
- For blind hole and through hole threads

Note:

Depending on the workpiece material, the essential advantages of the cold-forming of threads are not only excellent surface quality but also higher static and dynamic strength of the thread.

The length of the thread to be produced is not limited by chips which must be removed. The tools feature an excellent stability, especially with small thread sizes.

All ductile materials can be cold-formed. Sufficient lubrication is essential. We generally recommend using oil grooves for through hole threads and horizontal machining. (Exception: very short through hole threads, e.g. sheet metal components).

Sometimes, it is necessary to adjust the recommended thread hole preparatory diameter to work conditions.

InnoForm

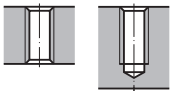

Evtl. muss der empfohlene Gewindekernloch-Vorfertigungsdurchmesser den Einsatzbedingungen angepasst werden.

2.4 EMUGE Geometriebezeichnungen

2.4 Our EMUGE geometries

**Drück
InnoForm**

Für Stahlwerkstoffe

Diese bewährte Geometrie ist für die allgemeine Anwendung in Stahl konzipiert. Sie ist in vielen Gewindesystemen und Abmessungen auf Lager. In Kombination mit Hartstoffschichten können Umfangsgeschwindigkeiten erhöht werden.

- **InnoForm-STEEL-M**
Für Stahlwerkstoffe mit mittlerer Festigkeit
- **InnoForm-STEEL-H**
Für Stahlwerkstoffe mit hoher Festigkeit

For steel materials

This highly successful geometry has been designed for general use in steel. It is available ex stock in numerous thread systems and sizes. Circumference speeds can be increased by combining it with a suitable hard surface coating.

- **InnoForm-STEEL-M**
For medium strength steels
- **InnoForm-STEEL-H**
For high strength steels

2.4 EMUGE Geometriebezeichnungen

2.4 Our EMUGE geometries

 InnoForm	<p>Für nichtrostende Stahlwerkstoffe und Stahlwerkstoffe</p> <p>Diese Werkstoffe verhalten sich stark adhäsiv, was zu Kaltpressschweißungen führen kann. Auch neigen diese Werkstoffe bei der Umformung stark zu verfestigen, wodurch die Formkeile stärker belastet werden. Um hier entgegenzuwirken, wurde eine Geometrie entwickelt, die den hohen Anforderungen hinsichtlich der Stabilität genügt.</p>	<p>For stainless steel materials and steel materials</p> <p>These materials show a high degree of adhesion which can lead to cold-welding effects. Also, they tend to strengthening during the forming process which puts more stress on the forming lobes. In order to compensate this, we have developed a geometry which meets the elevated requirements towards stability perfectly.</p>
 InnoForm	<p>Für Aluminium-Knetlegierungen</p> <p>Diese Werkstoffe zeigen unter üblichen Schmierungsverhältnissen, wie beispielsweise Emulsionsschmierung, eine stark adhäsive Neigung bei der Umformung des Gewindes. Um trotz dieses ungünstigen Werkstoffverhaltens ein positives Arbeitsergebnis zu erzielen, ist diese Geometrie mit einer Beschichtung ausgestattet, die sehr gute Reibungs- bzw. Gleiteigenschaften und damit eine optimale Prozesssicherheit bietet.</p>	<p>For aluminium wrought alloys</p> <p>Under the usual lubrication conditions, e.g. emulsion lubrication, these materials show a strong inclination to adhesion in the cold forming of threads. In order to obtain satisfactory work results in spite of these unfavourable material properties, this geometry was provided with a coating that offers excellent friction characteristics and, as a result, a perfect degree of process safety.</p>
 Drück InnoForm	<p>Für Aluminium-Gusslegierungen</p> <p>Bei der Anwendung von Gewindeformern in Aluminiumguss-Werkstoffen, stellt sich eine starke abrasive Belastung der Formkeile ein. Weiterhin sind die Umformeigenschaften dieser eher spröden Materialien als relativ schlecht einzuordnen. Um bei diesen schwierigen Bedingungen sehr gute Ergebnisse hinsichtlich des Gewindefertigungsprozesses und des Verschleißes zu erhalten, wurde bei diesem Typ die Geometrie angepasst und der Former zusätzlich mit einer Hartstoffschicht versehen.</p>	<p>For aluminium cast alloys</p> <p>Cast aluminium materials exert a very strong abrasive stress on the forming lobes of a cold-forming tap during work. In addition, the ductile properties of these rather brittle materials must be regarded as relatively poor. In order to achieve easier thread production and better wear resistance even under these bad conditions, we have given this tool type a specially adjusted geometry and an additional hard surface coating.</p>
 InnoForm	<p>Für hochfeste Werkstoffe</p> <p>Diese Geometrie wurde ausgelegt, um Werkstoffe umzuformen, deren Umform-eigenschaften eingeschränkt sind. Die spezielle Werkzeuggeometrie mit einer entsprechenden Hartstoffschicht liefert eine gute Qualität der gefertigten Gewinde bei sehr guter Verschleißbeständigkeit.</p>	<p>For materials of high tensile strength</p> <p>This geometry was designed for the cold forming of materials with restricted ductile properties. The special tool geometry, combined with an appropriate hard surface coating, provides excellent quality of the finished threads and very good wear resistance.</p>
 InnoForm	<p>Für CNC-gesteuerte Maschinen</p> <p>Diese Geometrie zielt darauf ab, speziell für CNC-gesteuerte Maschinen die entstehenden Reibungskräfte und Wärmebelastungen an den Formkeilen zu verringern. Bei synchron gesteuertem Vorschub kommt die Leistungsfähigkeit besonders in Verbindung mit Spannzangen-Aufnahmen der Typenreihe Softsynchro® zum Tragen.</p>	<p>For CNC-controlled machines</p> <p>This geometry is aimed at reducing the unavoidable friction forces and the heat stress on the forming lobes especially for use on CNC-controlled machines. With a synchronous feed control, the performance potential of these tools can be used to the full, especially in combination with the collet holders of our Softsynchro® series.</p>
 Drück	<p>Zum Hochgeschwindigkeitsbohren</p> <p>CNC-Maschinen, besonders in Verbindung mit Spannzangen-Aufnahmen der Typenreihe Speedsynchro® Modular, geben die Voraussetzung, hohe Drehzahlen zu fahren. Die spezielle Geometrie, in Verbindung mit einer Hartstoffschicht, bietet hier die Möglichkeit, auch hohe Schnittgeschwindigkeiten zu realisieren.</p>	<p>For high-speed tapping</p> <p>CNC machines, especially in combination with the collet holders of our Speedsynchro® Modular series, make very high speeds possible. The special geometry of these tools, combined with a hard surface coating, offers you the chance to do your machining at the highest speeds your machine can manage.</p>



- Product Finder
- V_c
- M
- MF
- UNC
- UNF
- G
- SELF-LOCK

2.5 EMUGE Oberflächenbehandlungen und -Beschichtungen

2.5 Our EMUGE surface treatments and coatings

Tech. Info

NT



Nitrieren

Durch thermochemische Behandlung wird die Oberfläche im Bereich von ca. 0,03 bis 0,05 mm Eindringtiefe mit Stickstoff angereichert. Da die Oberfläche sehr hart (1000-1250 HV) wird, eignen sich nitrierte Werkzeuge für abrasive Werkstoffe wie Grauguss, Sphäroguss, Aluminiumguss sowie auch Duroplaste. Der Standwert wird entscheidend erhöht.

Nitriding

In a thermo-chemical treatment, the surface is enriched with nitrogen to a depth of approx. 0.03 to 0.05 mm. Since the surface becomes very hard (1000-1250 HV), nitrided tools are a very good choice for abrasive materials like cast iron, spheroidal cast iron, cast aluminium and duroplastics. Tool life is increased in a decisive manner.

TIN

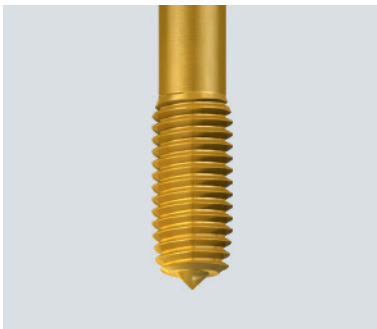

Titannitrid (goldgelb)

Im PVD-Verfahren (500 °C) werden Schichtdicken von 3-7 µm erreicht. Die **glatten** Schichten zeichnen sich durch hohe Schichthftung und TIN-typische Eigenschaften gegen Aufschweißungen aus.

TIN-Schichtsysteme mit Zusatzkennnummer (z.B. TIN-66, TIN-80) sind bezüglich Substrat, Werkzeuggeometrie und Anwendung optimiert.

Titanium nitride (gold-yellow)

In a PVD process (500 °C) a coating thickness of 3-7 µm can be realised. The **smooth** coatings feature a high adhesion strength and TIN-typical properties against cold welding.

TIN coating systems with additional code number (e.g. TIN-66, TIN-80) are optimised with regard to substrate, tool geometry and application.

CR

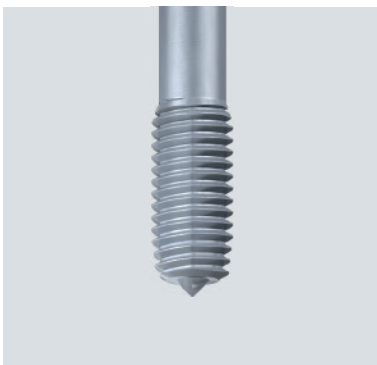

Hartverchromen

Die Hartchromschicht erreicht eine Härte von 1200 bis 1400 HV. Sie zeigt hervorragende Gleiteigenschaften. Die Schichtdicke beträgt 2-4 µm. Vor allem in Buntmetallen und Thermoplasten erreicht man Verbesserungen der Standwerte. Nicht zu empfehlen ist der Einsatz in Stahlwerkstoffen. Hier werden beim Umformvorgang Temperaturen von 250 °C sehr oft überschritten. Eine Haftung der Hartchromschicht ist dann nicht mehr gewährleistet.

Hard chrome plating

The hard chrome surface reaches a hardness of 1200 to 1400 HV, and shows excellent anti-friction properties. The thickness of the coating is 2-4 µm. Tool life can be considerably increased, especially in non-ferrous metals and thermoplastics. However, we do not recommend the use of this coating in steel materials. Here, temperatures of 250 °C are often exceeded in a cold-forming process, and that might endanger the adhesion of the hard chrome plating.

TICN

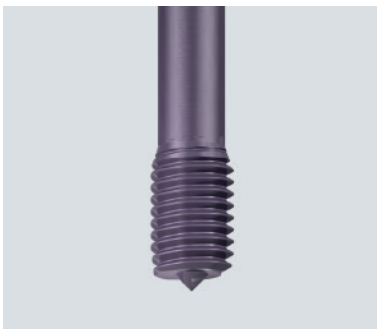

Titan-Carbonitrid (blau-grau)

Im PVD-Verfahren (500 °C) werden Schichtdicken von 2-4 µm erreicht. Die Härte beträgt hier ca. 3000 HV. Die TICN-Schicht bleibt bis ca. 400 °C beständig.

TICN-Schichtsysteme mit Zusatzkennnummer (z.B. TICN-67) sind bezüglich Substrat, Werkzeuggeometrie und Anwendung optimiert.

Titanium carbonitride (blue-grey)

In a PVD process (500 °C) a coating thickness of 2-4 µm can be realised. The hardness is approx. 3000 HV. The TICN coating will resist up to approx. 400 °C.

TICN coating systems with additional code number (e.g. TICN-67) are optimised with regard to substrate and application.

GLT-8

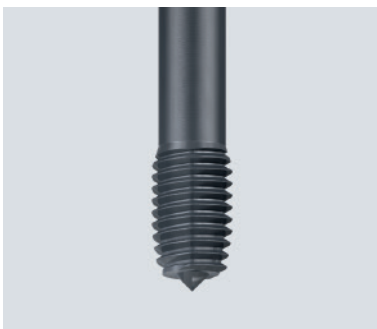

Diamantähnliche, amorphe Kohlenstoffschicht (schwarz-grau)

Im PVD-Verfahren werden Schichtdicken von ca. 1-2 µm erreicht. Die Härte beträgt ca. 2500 HV. Diese Monolayerschicht eignet sich hervorragend zur Bearbeitung von Buntmetallen und Aluminium mit niedrigem Si-Gehalt (< 7% Si). Durch den geringen Reibwert wird Werkstoffadhäsion stark vermindert. Die Schicht bleibt bis ca. 350 °C beständig.

Diamond-like, amorphous carbon coating (black-grey)

In a PVD process a coating thickness of 1-2 µm can be realised. The hardness is approx. 2500 HV. This mono-layer coating is an excellent choice for the machining of non-ferrous metals and aluminium with a low silicon content (< 7% Si). Thanks to the low friction, material adhesion is drastically reduced. This coating will remain resistant up to approx. 350 °C.

2.6 Sonstige EMUGE-Kurzbezeichnungen

2.6 Other EMUGE abbreviations

Product
FinderV_c

M

MF

UNC

UNF

G

SELF-LOCK

Tech. Info

IKZ

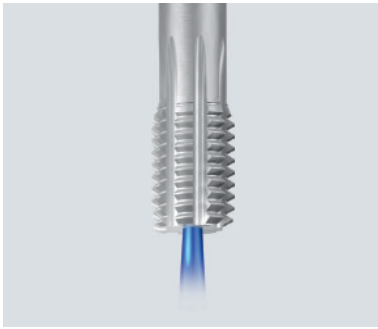
**Innere Kühlschmierstoff-Zufuhr, axial
(DIN-Bezeichnung: KA)**

Axialer Austritt des Kühlschmierstoffes bietet optimale Kühlschmierung im Anformkegelbereich.

**Internal coolant supply, axial
(DIN designation: KA)**

The axial exit of coolant-lubricant provides optimum cooling and lubrication in the lead taper area.

IKZN

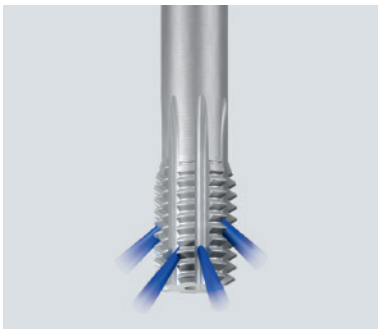
**Innere Kühlschmierstoff-Zufuhr, axial
mit Austritt in den Schmiernuten
(DIN-Bezeichnung: KR)**

Radialer Austritt bringt auch beim Durchgangsloch den Kühlschmierstoff prozesssicher in den Anformkegelbereich.

**Internal coolant supply, axial,
with coolant exiting in the flutes
(DIN designation: KR)**

Radial exit of coolant-lubricant is the safest solution for providing coolant supply in the lead taper area even in through holes.

BL

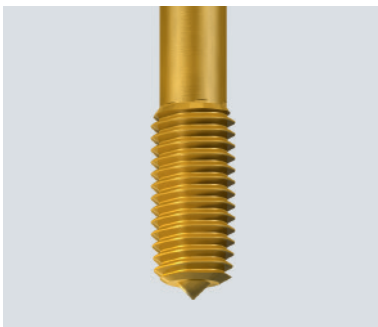
**Für Blechdurchzüge**

Die Ausführung BL basiert je nach Werkstoffwahl auf dem jeweiligen InnoForm-Grundwerkzeug. Allerdings wird der Anformkegel verlängert, um eine bessere Zentrierung des Werkzeuges zu erreichen. Zusätzlich garantiert die erhöhte Gewindelänge ein sicheres Reversieren, auch bei ungenaueren Umschaltzyklen.

For sheet metal components

The various BL designs are based each on an appropriate basic InnoForm tool, depending on the choice of material. Their special features include an extra long lead taper for a safer centering of the tool, and increased thread length for safe reversal, even with less exact reversing cycles.

VHM

**Vollhartmetall**

Werkzeuge mit einem Gewindenenddurchmesser < 12,0 mm werden aus Vollhartmetall (Gewinde- und Schaftteil) gefertigt.

Solid carbide

Tools with a thread diameter < 12.0 mm are made of solid carbide (thread part and shank).



- Product Finder
- V_c
- M
- MF
- UNC
- UNF
- G
- SELF-LOCK
- Tech. Info

2.7 Anformkegelformen

Anformkegelformen und Anformkegellängen für Gewindeformer nach DIN 2175.

2.7 Lead taper forms

Lead taper forms and lead taper lengths for cold-forming taps acc. DIN 2175.

Form C

Anformkegellänge 2-3 Gänge

Lead taper length 2-3 threads

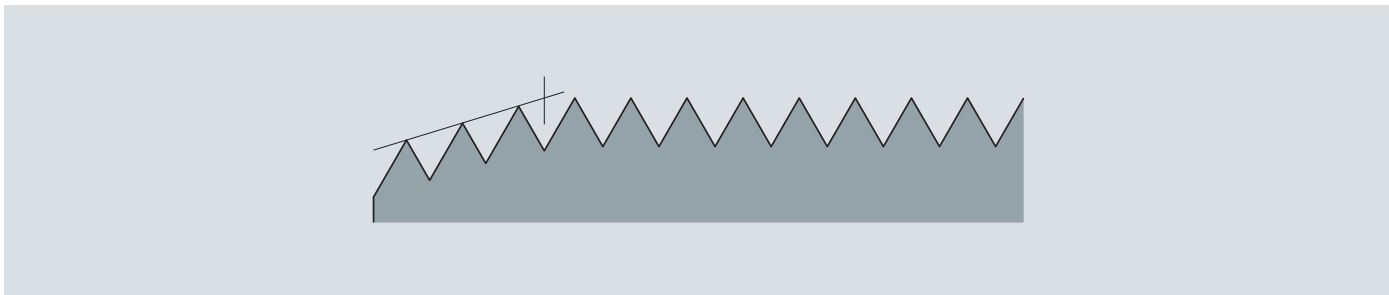

Form D

Anformkegellänge 3-5,5 Gänge

Lead taper length 3-5.5 threads

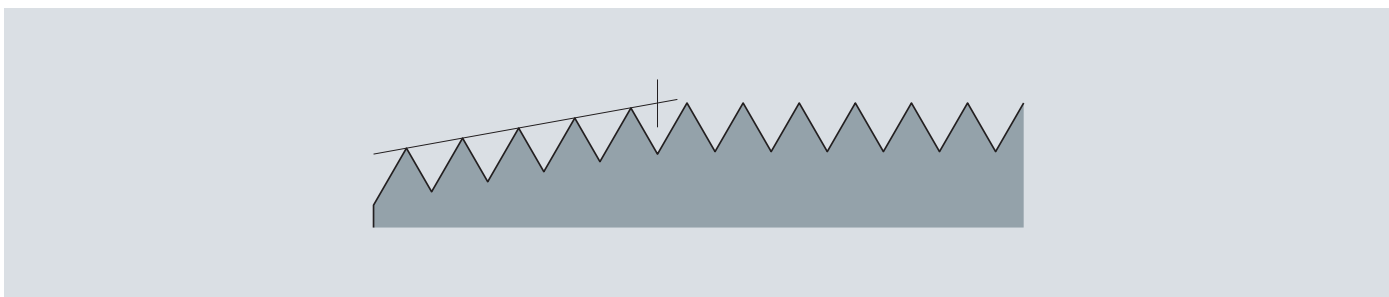

Form E

Anformkegellänge 1,5-2 Gänge

Lead taper length 1.5-2 threads

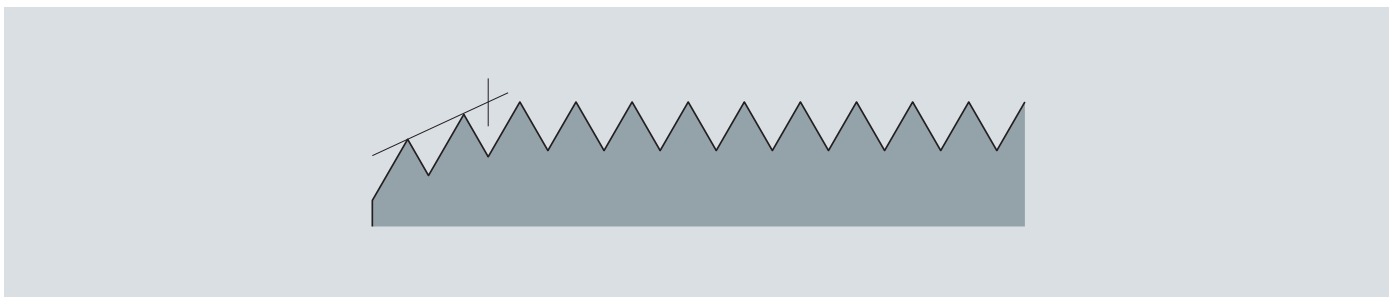

Form F

Anformkegellänge 1-1,5 Gänge

Lead taper length 1-1.5 threads

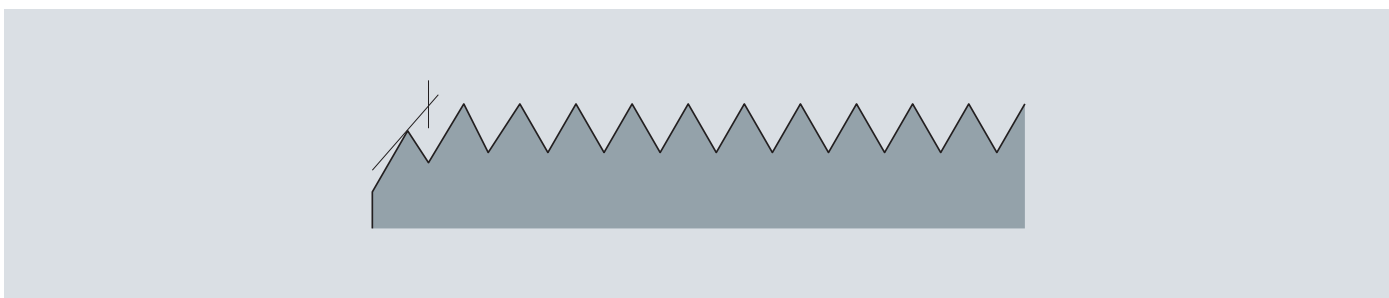

2.8 Kühl- und Schmierstoffe

Dem Schmiermittel wird im Allgemeinen zu wenig Bedeutung geschenkt. Um vom Werkzeug die volle Leistung zu erhalten, muss der richtige Kühlschmierstoff verwendet werden.

Grundsätzlich unterscheiden wir folgende Arten der Kühlung und Schmierung:

E

Emulsion

(EMUGE-Gewindeschneidöl Nr. 3+ EMULSION)

Die gebräuchlichste Kühlschmierung auf Bearbeitungszentren.

2.8 Cooling and lubrication agents

Lubricants are often, if not generally, given too little consideration. If you want to get the best performance out of your tool you have to take care to use the best coolant-lubricant available.

In general, we distinguish the following types of cooling and lubrication:

Emulsion

(EMUGE thread cutting oil no. 3+ EMULSION)

The most common type of coolant-lubricant on machining centres.

M

Minimalmengenschmierung (MQL)

Durch die Möglichkeit Luft-Ölgemisch bei modernen Bearbeitungszentren durch die Spindel zu fördern, gewinnt diese Art der Kühlschmierung mehr und mehr an Bedeutung.

Minimum-quantity lubrication (MQL)

Due to the more and more common option of supplying aerosol through the spindle on modern machining centres, this type of cooling and lubrication is gaining more and more popularity.

O

Gewindeschneidöl

(EMUGE-Gewindeschneidöle Nr. 1+ STEEL, Nr. 2+ CAST IRON, Nr. 4+ NON FERROUS, Nr. 5+ HIGH ALLOY)

Abgestimmt auf die zu bearbeitenden Werkstoffe werden hervorragende Gewindeoberflächen und Standwerte erreicht.

Thread cutting oil

(EMUGE thread cutting oils no.1+ STEEL, no. 2+ CAST IRON, no. 4+ NON FERROUS, no. 5+ HIGH ALLOY)

With these oils which are perfectly adjusted to specific materials, excellent thread surfaces and tool life can be achieved.

P

Gewindeschneidpaste

(EMUGE-Gewindeschneidpaste Nr. 6+ PASTE)

Zum Gewindeformen hervorragend geeignet. Besonders vorteilhaft bei waagrechtter Bearbeitung, großen Abmessungen und Durchgangslochgewinden. Kann nur für Pinselschmierung verwendet werden.

Thread cutting paste

(EMUGE thread cutting paste no. 6+ PASTE)

Perfectly suitable for the cold forming of threads. Especially useful in horizontal machining, with large thread sizes and through hole threads. To be used only for brush lubrication.



- Product Finder
- V_c
- M
- MF
- UNC
- UNF
- G
- SELF-LOCK
- Tech. Info

2.9 Toleranzfelder des Flankendurchmessers beim Metrischen Gewinde (schematische Darstellung)

2.9 Tolerance zones of the pitch diameter on the Metric thread (graphic representation)

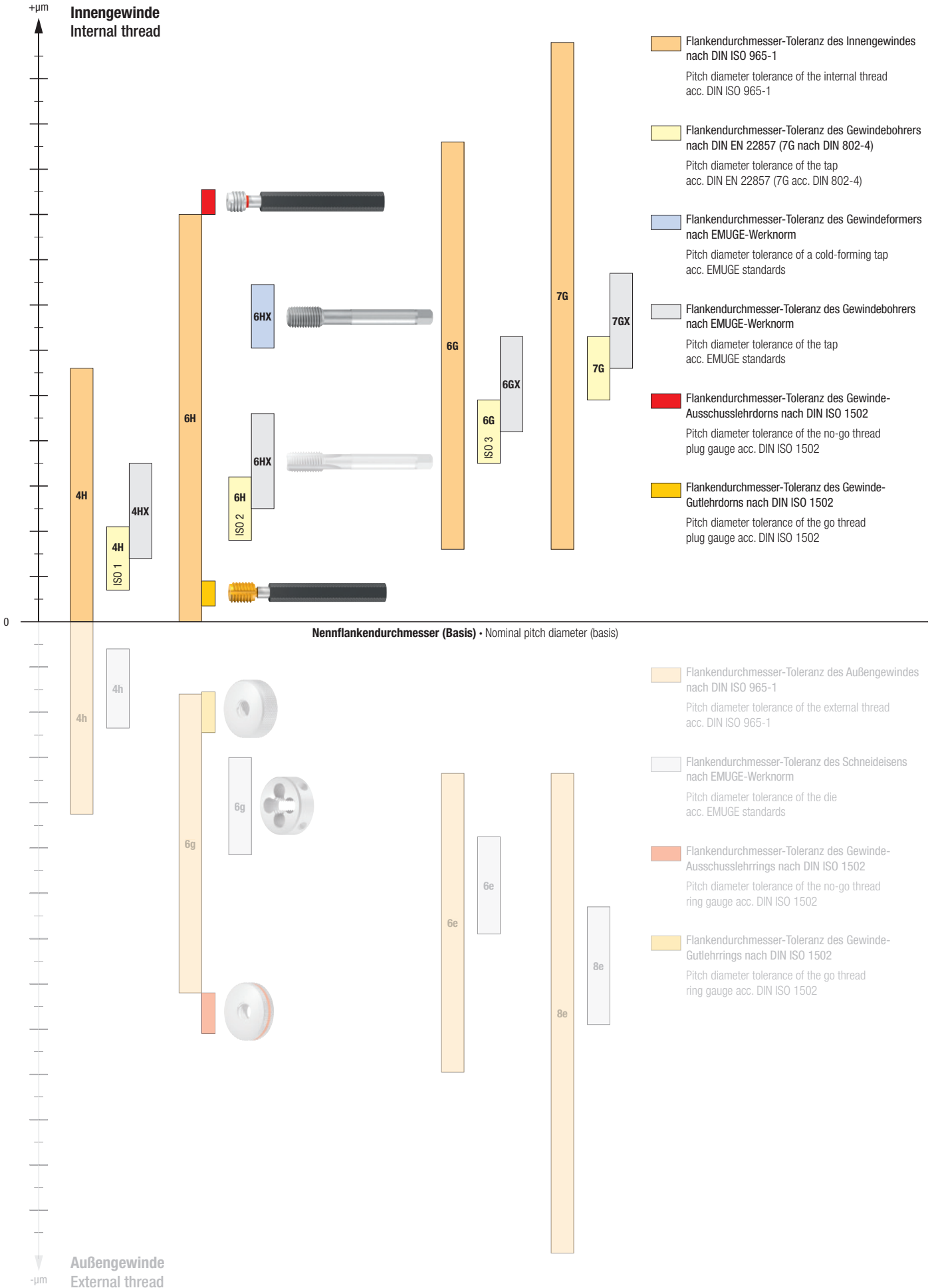

2.10 Toleranzfelder des Flankendurchmessers beim Unified-Gewinde (schematische Darstellung)

2.10 Tolerance zones of the pitch diameter on the Unified thread (graphic representation)

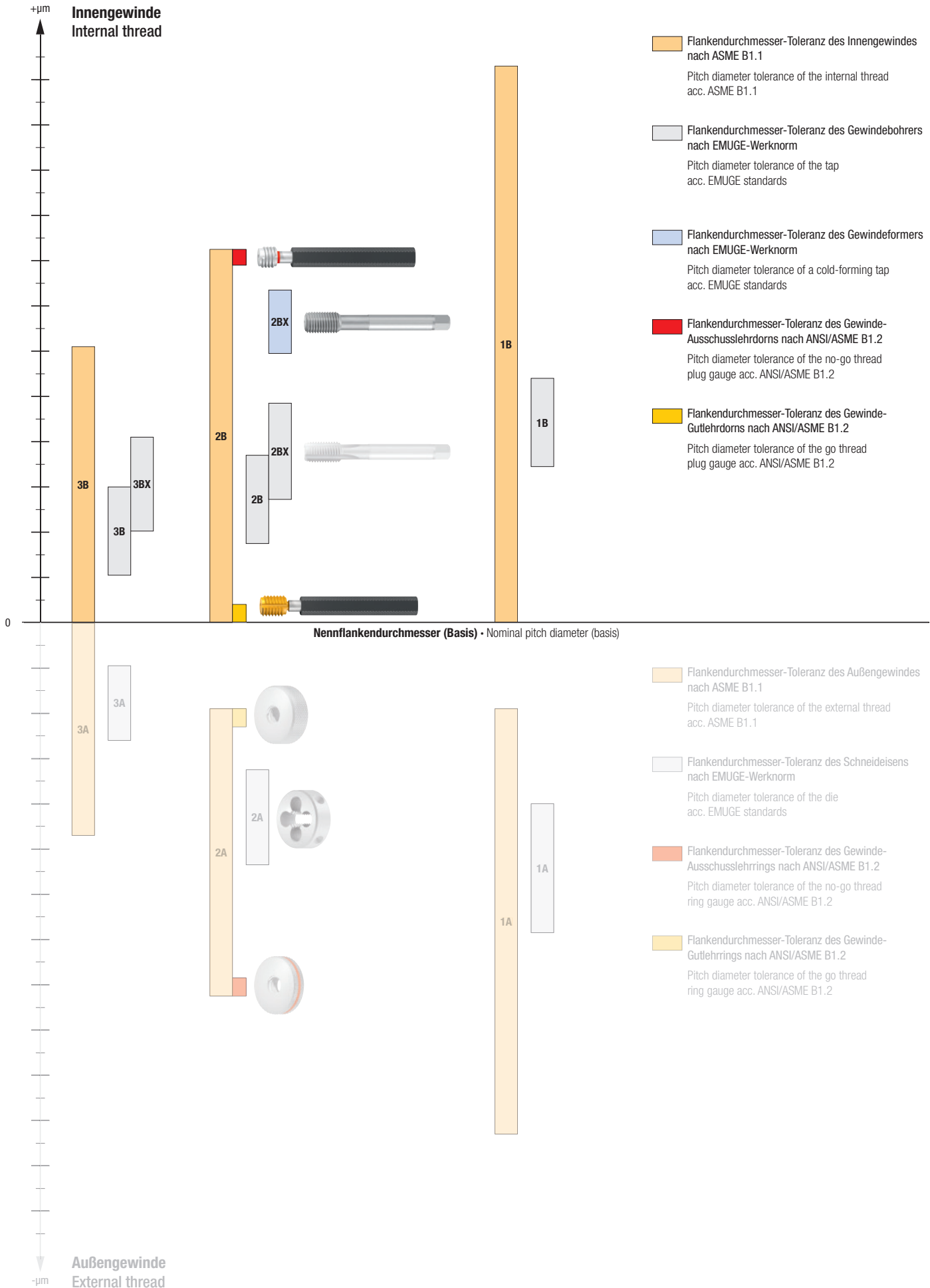

Product Finder

V_c

M

MF

UNC

UNF

G

SELF-LOCK

Tech. Info



- Product Finder
- V_c
- M
- MF
- UNC
- UNF
- G
- SELF-LOCK
- Tech. Info

2.11 Schematischer Drehmomentverlauf beim Gewindeformen

2.11 Schematic of torque curve in the cold forming of threads

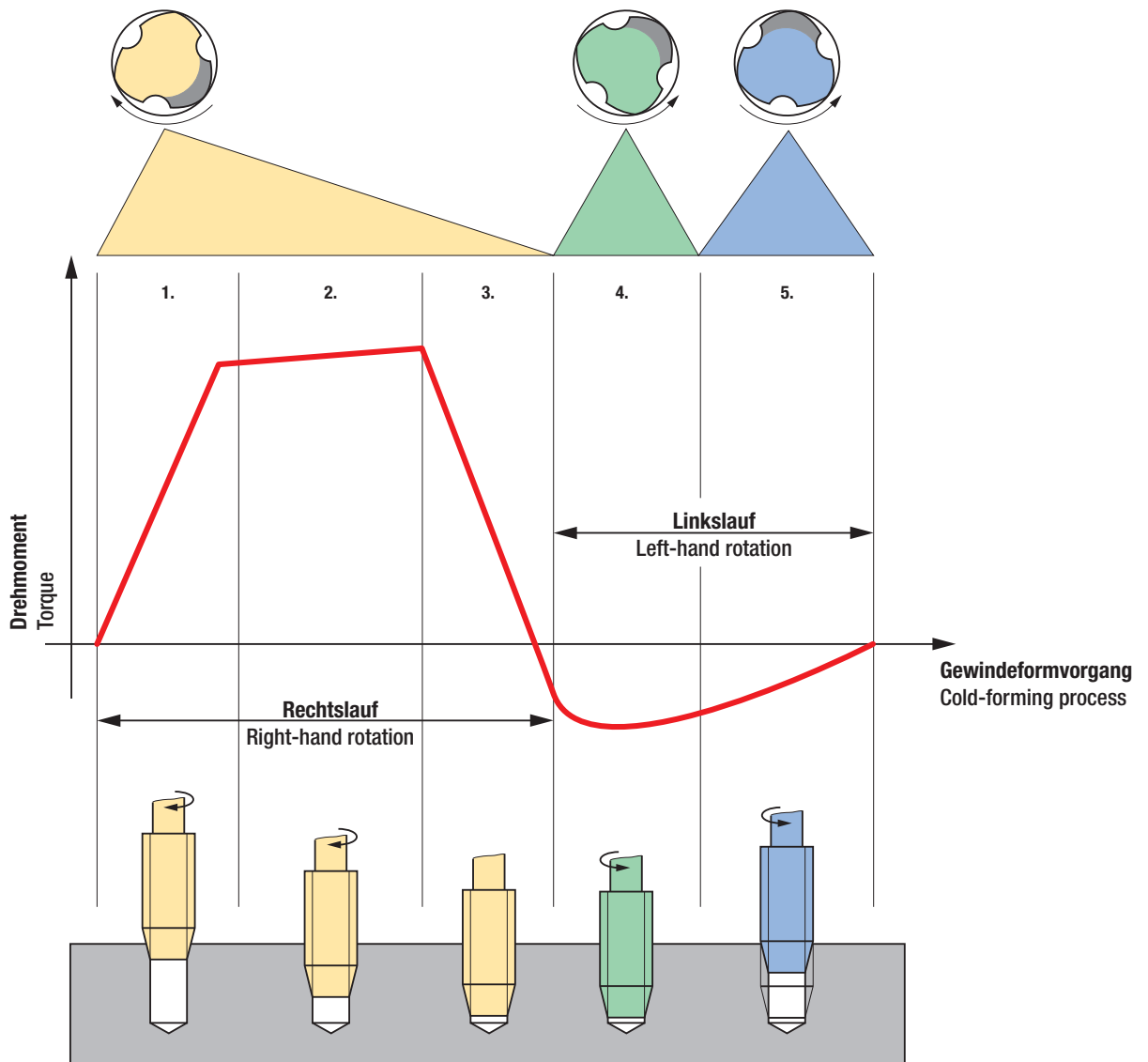

1. Anformen des Gewindeformers bis zum Eingriff aller Anformzähne

2. Formmomente des vollständig im Eingriff befindlichen Anformkegels

3. Abbremsen der Maschinenspindel bis zum Stillstand

1. Beginning of forming process until all lead taper teeth are in contact.

2. Forming work of the lead taper which is now in full contact.

3. Braking the machine spindle to a stop

4. Beginnender Rücklauf der Spindel mit Gleitreibung

4. Beginning reversal of the spindle with sliding friction

5. Gleitreibung zwischen Gewindeformer und Werkstück

5. Sliding friction between cold-forming tap and workpiece

2.12 Umformverhalten und Drehmoment

2.12 Cold forming and torque

Kennwerte des Werkstück-Werkstoffes

Nicht alle Werkstoffe sind zum Formen geeignet. Sie müssen ein Mindestmaß an Fließfähigkeit aufweisen und dürfen eine bestimmte Werkstofffestigkeit nicht überschreiten. Geeignete Werkstoffe liegen in der Zugfestigkeit unter 1400 N/mm², bei einer Bruchdehnung von mindestens 5%. Außerdem führen unterschiedliche Materialien und deren Legierungen zu sehr spezifischen Fließigenschaften und Verfestigungsverhalten. Es ist offensichtlich, dass z.B. Knetaluminium, hochfester Stahl oder VA-Material völlig unterschiedlich reagieren.

Drehmoment

Das Drehmoment beim Gewindeformen ist im Wesentlichen abhängig vom zu bearbeitenden Material, der Gewindeabmessung, von Schmierung und Gewindekernloch-Vorfertigungsdurchmesser, sowie der Geometrie und Beschichtung des Werkzeuges. Den Einfluss des Vorfertigungsdurchmessers auf das Drehmoment zeigt das folgende Diagramm.

Technical data of the workpiece material

Not all materials are suitable for cold forming. For that, they must show a minimum value of ductility and must not exceed a certain maximum strength. Suitable materials usually have a tensile strength of less than 1400 N/mm² and a minimum fracture strain of 5%. In addition, different materials and their alloys lead to very specific flow properties and strengthening characteristics. Obviously, wrought aluminium, high-strength steel or stainless materials will react in very different ways.

Torque

Torque, in the cold forming of threads, depends mostly on the workpiece material, the thread size, lubrication and thread hole preparatory diameter, as well as on the geometry and the coating of the tool. The influence of the preparatory diameter on torque is shown in the following diagram.

InnoForm, M10-6HX
Werkstoff C45
n = 350 min⁻¹
InnoForm, M10-6HX
Material C45
n = 350 rpm

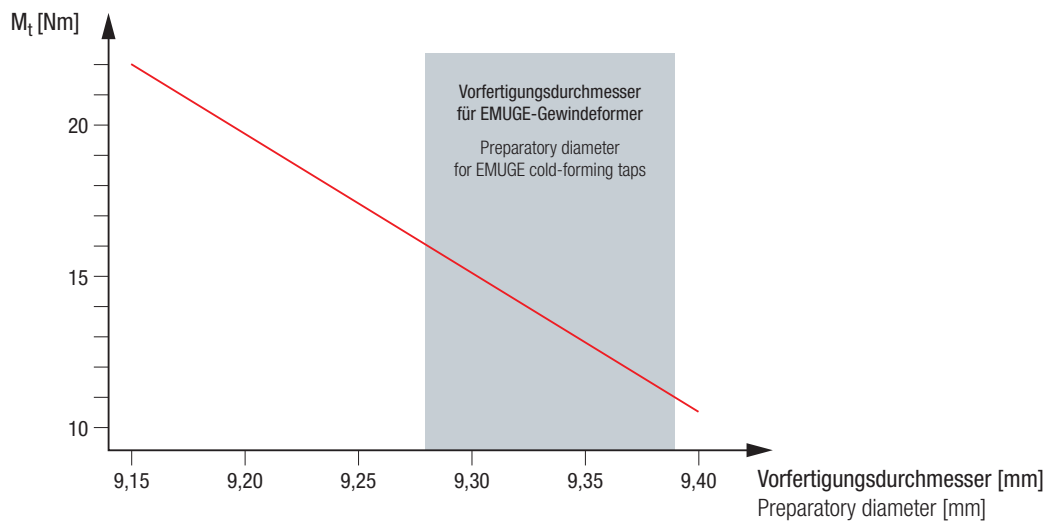

Die folgende Grafik zeigt schematisch den Drehmoment-Unterschied zwischen Gewindebohren und Gewindeformen.

The following diagram demonstrates the difference in torque between thread cutting and cold forming.

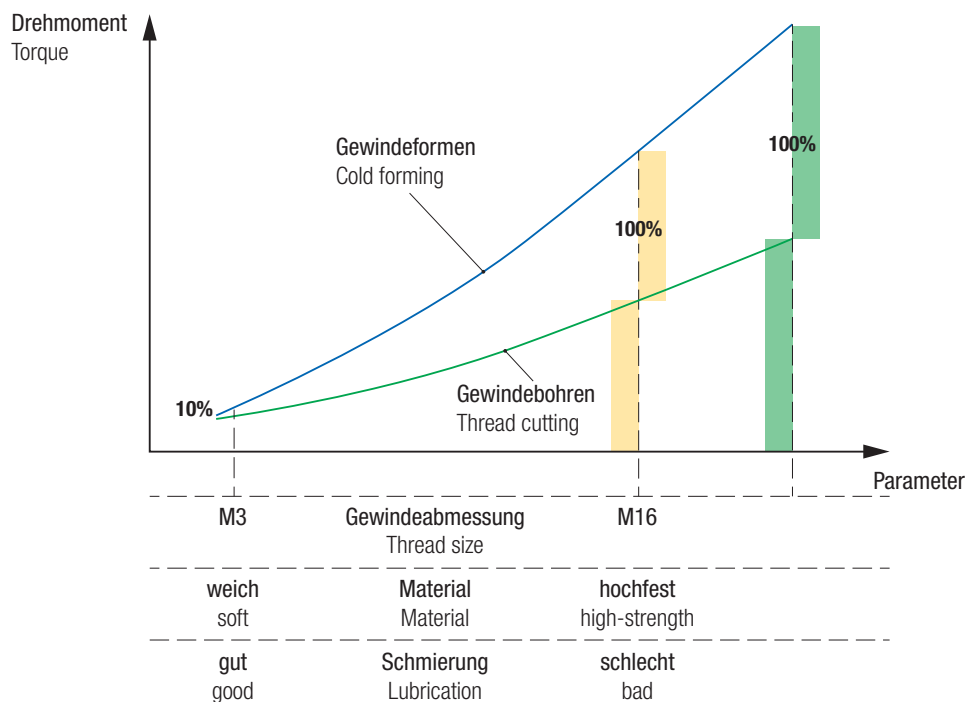

- Product Finder
- V_c
- M
- MF
- UNC
- UNF
- G
- SELF-LOCK
- Tech. Info**



- Product Finder
- V_c
- M
- MF
- UNC
- UNF
- G
- SELF-LOCK
- Tech. Info

2.13 Das Fertigungsverfahren Gewindeformen

Das Gewindeformen ist nach DIN 8583-5 den druckumformenden Verfahren zugeordnet. Das Innengewinde wird durch Eindrücken der schraubenförmig angeordneten Gewindeflächen in die vorgefertigte Bohrung druckumformend erzeugt. Das Gewindeformwerkzeug besitzt einen Anformkegel sowie einen zylindrischen Führungsteil. Durch beide Bereiche verläuft schraubenförmig der Gewindegang. Im Querschnitt ist senkrecht zur Werkzeugachse ein polygonförmiges Profil zu erkennen. Dadurch ergeben sich Formkeile mit dem wirksamen Gewindeprofil.

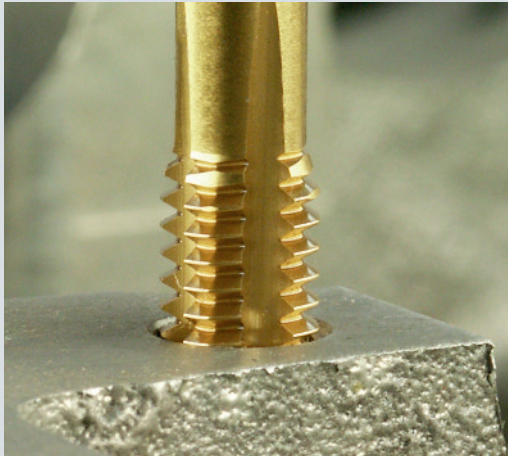

2.13 Cold forming as a production process

The cold forming of threads, according to DIN 8583-5, belongs to the pressure-forming processes. The internal thread is produced by the impression of a helical sequence of thread teeth into the formerly prepared thread hole, the desired profile is formed by pressure. A cold-forming tap is provided with a lead taper and a cylindrical guiding part. The thread helix runs on through both parts. If you look at a cross-section of the tool, there is a polygon shape to be recognised at a right angle to the tool axis. This polygon shape provides forming lobes which carry the effective thread profile.

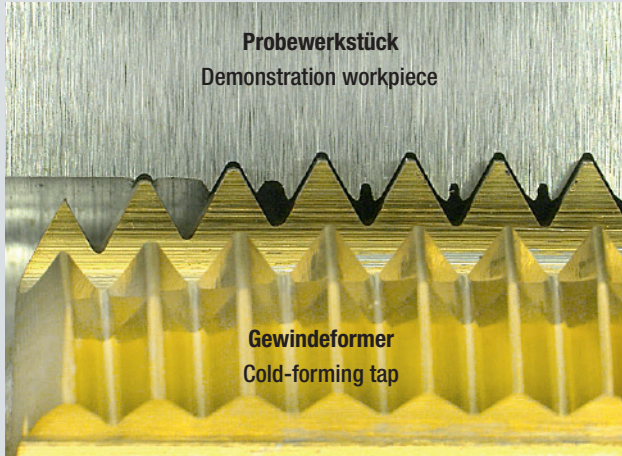

Der Anformbereich ist ausgebildet als Anformkegel, in dem der schraubenförmige Gewindegang im Durchmesser zunimmt. Im Formprozess erzeugt der Anformbereich das Gewinde, wobei die Formkeile nacheinander mit radialer Zustellung in Eingriff kommen und das Gewinde ausformen. Hierbei fließt das Werkstückmaterial von den Gewindespitzen entlang der Gewindeflanken in den Gewindekernbereich. Es entstehen geglättete Flanken sowie im Gewindekernbereich die typische „Kralle“.

Der zylindrische Führungsteil des Gewindeformers glättet die geformte Gewindefläche nach und dient zur axialen Führung des Werkzeugs. Abhängig vom zu bearbeitenden Material sind die wesentlichen Vorteile des Gewindeformens neben sehr guter Oberflächenqualität auch höhere statische und dynamische Festigkeit des Gewindes. Die zu erzeugende Gewindelänge wird nicht durch abzuführende Späne begrenzt, wodurch eine hohe Prozesssicherheit erreicht wird. Die hohe Eigenführung des Werkzeuges verhindert axiales „Verschneiden“. Hervorragende Stabilität des Werkzeuges ist besonders bei kleinen Abmessungen hilfreich.

The lead portion of a cold-forming tap is made as a lead taper, in which the helical thread line is continuously increasing in diameter. In the cold-forming process, the lead taper produces the thread, the forming lobes penetrating the workpiece successively in a radial direction by forming the thread. During this process, the workpiece material “flows” from the thread crests along the thread flanks into the area of the minor thread diameter. This creates smooth flank surfaces and, in the minor diameter area, the typical space pocket. The cylindrical guiding part of the cold-forming tap makes the surface of the produced thread even smoother, and serves to firmly guide the tool axially. Depending on the workpiece material, the essential advantages of cold forming include excellent surface quality but also increased static and dynamic strength of the thread. The length of the thread to be produced is not limited by chips which need to be removed, so process safety is extremely good. The excellent self-guiding characteristics of a cold-forming tap prevent axial “miscutting”. The extraordinary stability of the tools is very helpful, especially with small diameters.

2.14 Der Unterschied zwischen spanend hergestelltem und geformtem Innengewinde

Beim spanend hergestellten Innengewinde werden die zulässigen Belastungswerte durch Zerschneiden der Werkstofffasern beeinträchtigt. Außerdem können Flankenwinkelfehler leichter auftreten, die ungünstige Spannungsverteilungen verursachen und den Traganteil vermindern. Beim geformten Innengewinde ergeben sich nichtunterbrochene Fasern und ein kaltverfestigter Werkstoff. Zusätzliche Flankenwinkelabweichungen, die bei spanend hergestellten Gewinden auftreten können, werden vermieden, weil sich der Werkstoff spielfrei an die Flanke des Werkzeugs verformt. Der unvollständig ausgeformte Kern, ein typisches Merkmal geformter Gewinde, hat keinen Einfluss auf die Ausreißfestigkeit. Durch das Gewindeformen ergeben sich in den Gewindeflanken und insbesondere im Gewindegrund Verfestigungen im Werkstoffgefüge. Diese wirken sich positiv auf die Schwing- und Wechselfestigkeit bei dynamisch beanspruchten Bauteilen aus.

2.14 The difference between a cut thread and a cold-formed thread

With a cut thread, the permissible stress values are limited due to the fact that the grain structure of the material is cut. Also, flank angle errors can occur easily; these will cause a very unfavourable distribution of stress on the thread and limit its holding strength. With a cold-formed thread, the grain of the material is not cut or interrupted, and the material itself shows increased strength, due to its having been compressed by cold-forming. Flank angle errors which are quite common in cut threads are prevented by the material being formed, without any play, along the thread flanks of the tap. The incomplete minor diameter, typical for cold-formed threads, has no influence on the stripping resistance of the thread. Cold forming causes material strengthening on the thread flanks and especially in the root area of the thread. This strengthening of the material structure has a very positive influence on the vibration properties and the general resistance of the thread under dynamic stress.

Spanend hergestelltes Gewinde
Cut thread

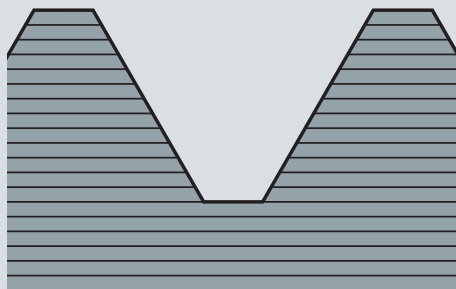
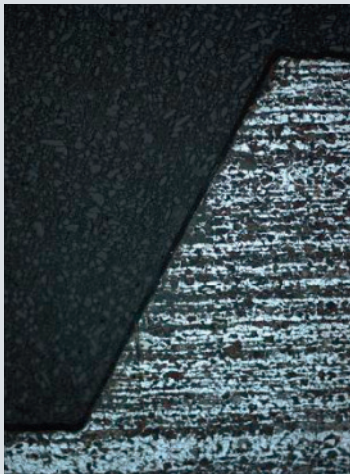

Faserverlauf beim spanend hergestellten Gewinde
Grain structure in a cut thread

Geformtes Gewinde
Cold-formed thread

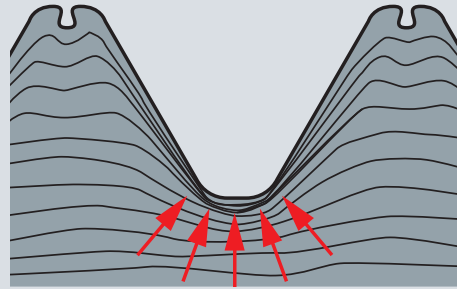
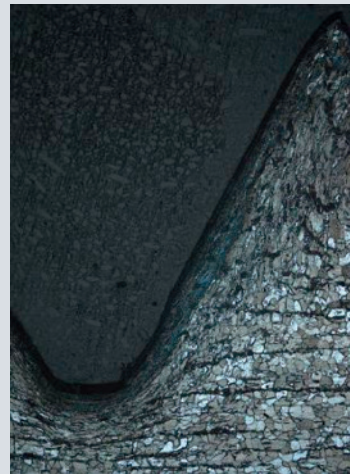

Faserverlauf beim geformten Gewinde, Verfestigung im rissgefährdeten Gewindegrund am Außendurchmesser erhöht die Dauerfestigkeit
Grain structure in a cold-formed thread, strengthening in the root area / on the major diameter which is especially exposed to the danger of crack formation increases resistance

Maximale Gewindetiefe, maximale Gewindesteigung

Über die maximal erreichbare Gewindetiefe und die größtmögliche kaltverformbare Gewindesteigung lässt sich keine generelle Aussage machen. Die erzielbare Gewindetiefe ist größer als beim spanenden Werkzeug. Sie ist in der Praxis hauptsächlich von der Qualität der Kühlschmierung abhängig und durch die Werkzeugbaulänge begrenzt. Die maximal umformbare Gewindesteigung wird von den Werkstück-Werkstoffeigenschaften begrenzt.

Maximum thread depth, maximum thread pitch

The maximum thread depth to be achieved and the fastest possible thread pitch to be produced by cold-forming are a topic about which a general statement is impossible. The possible thread depth is definitely larger than it could be with a cutting tap. In practical work, it depends primarily on the quality of cooling/lubrication, and is limited by the constructional length of the tool.

The maximum thread pitch in cold forming is limited by the workpiece material properties.

Product Finder

V_c

M

MF

UNC

UNF

G

SELF-LOCK

Tech. Info



- Product Finder
- v_c
- M
- MF
- UNC
- UNF
- G
- SELF-LOCK
- Tech. Info

2.15 Gewidekernloch-Vorfertigungsdurchmesser für Gewindeformer

Einfluss des Vorfertigungsdurchmessers

Bei zu kleinem Vorfertigungsdurchmesser wird das Werkstückmaterial im Gewidekern überformt und es treten sehr hohe Prozesskräfte auf. Ist zu groß vorgefertigt, wird der Gewidekernbereich nicht ausreichend ausgeformt, d.h. der Kerndurchmesser wird zu groß. Um diese negativen Effekte auszuschließen, ist die Toleranz des Vorfertigungsdurchmessers eingengt.

In Einsatzfällen mit sehr speziellem Umformverhalten kann es notwendig sein, vom empfohlenen Vorfertigungsdurchmesser abzuweichen und den erforderlichen Vorfertigungsdurchmesser durch Versuche zu ermitteln.

Es ist zu beachten, dass der Vorfertigungsdurchmesser den entstehenden Innengewinde-Kerndurchmesser beeinflusst, wie folgendes Beispiel zeigt. Die Vorfertigung ist sorgfältig herzustellen. Jede Ungenauigkeit und Oberflächenrauheit spiegelt sich im geformten Gewidekerndurchmesser wider.

2.15 Thread hole preparatory diameter for cold-forming taps

The influence of the preparatory diameter

If the preparatory diameter is too small the workpiece material is overformed in the thread root and there are excessive process forces. If the preparatory diameter is too large the thread root is not sufficiently formed, the minor diameter is too small. In order to preclude such negative effects, the tolerance of the preparatory diameter is narrowed down from the start.

In some cases where the forming characteristics are very extraordinary it may be necessary to go without a standard preparatory diameter entirely, and to find the correct diameter by testing.

It is important to know that the preparatory diameter has a decisive influence on the minor diameter of the nut thread, as the following example shows. Every lack of precision, every kind of surface roughness will be mirrored in the finished internal thread and its minor diameter.

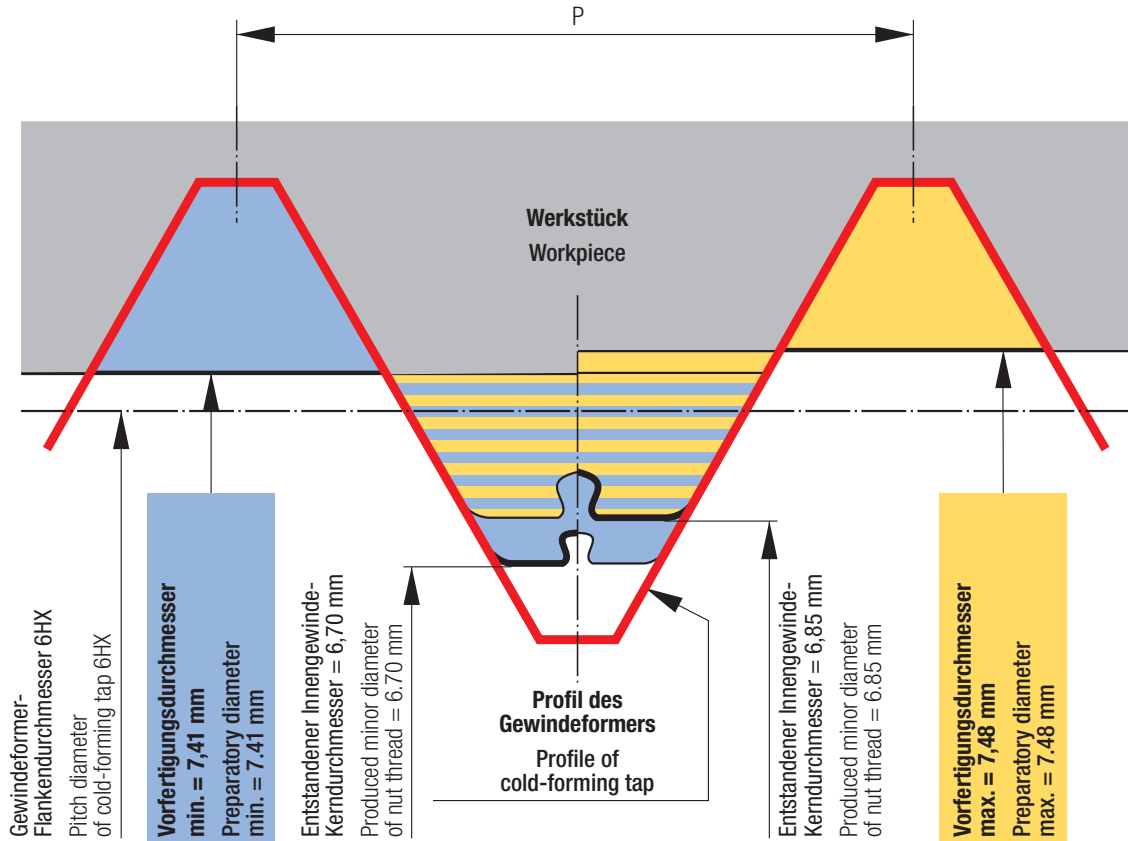

Geformtes Gewinde M8-6HX in rost- und säurebeständigem Material, z.B. Werkstoff-Nr. 1.4571, 1.4401, bei unterschiedlichen Vorfertigungsdurchmessern.

Cold-formed thread M8-6HX in corrosion- and acid-proof material, e.g. material no. 1.4571 or 1.4401, with different preparatory diameters.

Mutterhöhe = 2 x d
 $v_c = 6,4 \text{ m/min}$
 $n = 255 \text{ min}^{-1}$

Kühlschmierstoff:
 EMUGE-Gewindeschneidöl Nr. 5+ HIGH ALLOY

Nut height = 2 x d
 $v_c = 6.4 \text{ m/min}$
 $n = 255 \text{ rpm}$

Coolant-lubricant:
 EMUGE thread cutting oil no. 5+ HIGH ALLOY

Während die Einhaltung der Innengewideflankendurchmesser-Toleranz, z.B. 6H Metrisches ISO-Gewinde, beim Gewideformen meist keine Schwierigkeiten bereitet, ist beim Innengewidekerndurchmesser – wie oben angedeutet – mit Abweichungen zu rechnen.

While the observation of the pitch diameter tolerance of the internal thread, e.g. ISO metric thread 6H, offers no problems usually, deviations in the minor diameter of the internal or nut thread must be expected, as demonstrated above.

In DIN 13-50 sind die vergrößerten Kerndurchmesser-Toleranzen für geformte Innengewinde festgelegt. Diese Norm lässt ein Toleranzfeld von 7H für den Innengewidekerndurchmesser zu, bei einer Flankendurchmesser-Toleranz von 6H.

The extended minor diameter tolerances for cold-formed internal threads are specified in DIN 13-50. This standard allows a 7H tolerance for the minor diameter of the nut thread, with a pitch diameter tolerance of 6H.

- Product Finder
- V_c
- M
- MF
- UNC
- UNF
- G
- SELF-LOCK
- Tech. Info

2.16 Lehrung und Toleranzen geformter Innengewinde

Gewindelehrung – Kombination von Toleranzklassen

Die Gewindelehrung im Flankendurchmesser wird mit üblichen Gewinde-Grenzlehrdornen der zeichnungsmäßig festgelegten Gewindequalifizierung vorgenommen. Es ist zu beachten, dass für geformte Metrische Gewinde die Festlegung der Toleranzen nach DIN 13-50 anzuwenden ist.

Auszug aus DIN 13-50

Grenzabmaße und Toleranzen Limit allowances and tolerances

M Metrisches ISO-Regelgewinde DIN 13 ISO Metric coarse thread DIN 13

Gewinde-Kurzzeichen Thread specification	Flankendurchmesser bei Toleranzfeld 6H Pitch diameter for tolerance 6H		Kerndurchmesser bei Toleranzfeld 7H Minor diameter for tolerance 7H		Toleranz in µm Tolerance in µm
	min.	max.	min.	max.	
M 3	2,675	2,775	2,459	2,639	180
4	3,545	3,663	3,242	3,466	224
5	4,480	4,605	4,134	4,384	250
6	5,350	5,500	4,917	5,217	300
8	7,188	7,348	6,647	6,982	335
10	9,026	9,206	8,376	8,751	375
12	10,863	11,063	10,106	10,531	425
16	14,701	14,913	13,835	14,310	475

2.16 Gauging and tolerances of cold-formed threads

Thread gauging – Combination of tolerance classes

Thread gauging in the pitch diameter is done with the usual go/no-go thread plug gauges as specified in the well-known thread standards. It should be noted that for cold-formed Metric threads the specifications for tolerances according DIN 13-50 apply.

Extract from DIN 13-50

Grenzabmaße und Toleranzen Limit allowances and tolerances

MF Metrisches ISO-Feingewinde DIN 13 ISO Metric fine thread DIN 13

Gewinde-Kurzzeichen Thread specification	Flankendurchmesser bei Toleranzfeld 6H Pitch diameter for tolerance 6H		Kerndurchmesser bei Toleranzfeld 7H Minor diameter for tolerance 7H		Toleranz in µm Tolerance in µm
	min.	max.	min.	max.	
M 8 x 1	7,350	7,500	6,917	7,217	300
10 x 1	9,350	9,500	8,917	9,217	300
12 x 1,5	11,026	11,216	10,376	10,751	375
14 x 1,5	13,026	13,216	12,376	12,751	375
16 x 1,5	15,026	15,216	14,376	14,751	375

1. Anwendungsbereich

Diese Norm legt Gewindetoleranzen für durch Gewindeformen (siehe DIN 8583-5) herzustellende Innengewinde fest. Das Fertigungsverfahren Gewindeformen ist vorzugsweise für Regelgewinde M3 bis M16 und Feingewinde M8 x 1 bis M30 x 2 nach DIN ISO 262 und DIN ISO 965-2 anwendbar.

2. Toleranzen

Für durch Gewindeformen herzustellende Innengewinde der Einschraubgruppe N nach DIN ISO 965-1 werden nach DIN 13-50 folgende Toleranzfelder festgelegt:

- für Flankendurchmesser 6H (wie DIN ISO 965-1)
- für Kerndurchmesser 7H (DIN 13-50)

Hinweis: Bei Gewindetoleranzen, die nicht in DIN 13-50 genormt sind, ist sinnvollerweise analog zu verfahren, d.h., die Kerndurchmesser-Toleranz sollte gegenüber der Flankendurchmesser-Toleranz erhöht werden – in der Regel um eine Qualitätsstufe. In solchen Fällen ist allerdings durch den Werkzeuganwender zu klären, ob die erhöhte Toleranz im bearbeiteten Werkstück zulässig ist.

3. Toleranzen des Gewindeteils

Der Gewindeteil des Formers wird im Vergleich zum Gewindebohrer mit einer erhöhten Toleranzlage ausgeführt, da der Werkstoff nach der plastischen Verformung um den elastischen Anteil zurückfedert. Das erzeugte Gewinde ist deshalb kleiner als der Formteil des Formers. Der Former lässt sich nach dem Gewindeformen nicht nochmals von Hand in das Gewinde einschrauben, was beim Gewindebohren meist problemlos realisierbar ist. Darum ist es nötig, den Gewindeteil näher an die obere Toleranzgrenze des Innengewindes zu legen.

1. Application range

This standard specifies thread tolerances for internal threads to be produced by cold forming (see DIN 8583-5). The production process cold forming is to be used, preferably, for coarse threads M3 to M16 and for fine threads M8 x 1 to M30 x 2 according DIN ISO 262 and DIN ISO 965-2.

2. Tolerances

For internal threads of screw-in class N according DIN ISO 965-1, which are to be produced by cold forming, the following tolerance zones have been specified according to DIN ISO 13-50:

- for the pitch diameter 6H (as in DIN ISO 965-1)
- for the minor diameter 7H (DIN 13-50)

Note: For thread tolerances which are not specified in DIN 13-50, it is usually recommended to proceed in an analogue way, i.e. to raise the minor diameter tolerance in relation to the pitch diameter tolerance – normally by one tolerance step. However, in such cases the user has to check first if the raised tolerance is acceptable in the workpiece to be produced.

3. Tolerance of the thread part

The thread part of a cold-forming tap is generally produced with an increased tolerance since the workpiece material will always contract after the plastic forming process, depending on its elasticity. Consequently, the produced thread is always smaller than the thread part of the cold-forming tap. You will never be able to screw the cold-forming tap back into the thread manually after the cold-forming process, as would be possible without any problem with a cut thread and a cutting tap. For this reason, it is necessary to manufacture the thread part of a cold-forming tap closer to the upper tolerance limit of the internal thread.

2.17 Technischer Fragebogen: Gewindeformen

Firma:
 Ansprechpartner:
 Telefon:
 Fax:
 E-Mail:

Abmessung:
 Ausführung:
 Artikel-Nr.:
 Projekt:

Werkstückbezeichnung:

Kernlochdurchmesser:

- gebohrt geräumt gestanzt
 gegossen gezogen

Kernlochform (bitte Maße eintragen):

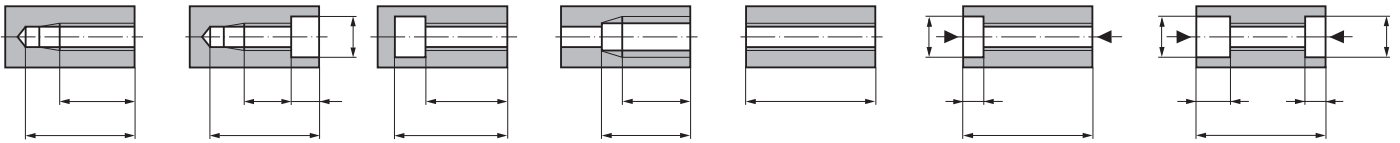

Maschine:

Hersteller:
 Typ:
 Antriebsleistung: kW

- horizontal Werkzeug rotierend
 vertikal Werkzeug stehend

Schnittdaten:

Drehzahl n: min⁻¹
 Umfangsgeschwindigkeit v_c: m/min

Vorschub:

- Andruckkurve Sonstige:
 Hydraulik
 Leitpatrone
 NC-gesteuert
 Synchronspindel
 Zahnräder

Werkzeugaufnahme:

- starr (Spannzange)
 Gewindeführapparat } Hersteller:
 Gewindeführfutter } Typ:
 mit Überlastkupplung
 mit Längenausgleich
 mit achsparalleler Pendelung
 mit innerer Kühlschmierstoff-Zufuhr Druck: bar

Spindelaufnahme:

MK / SK / HSK / TR / andere:
 DIN / ANSI / JIS / andere:

Werkstückwerkstoff:

Bezeichnung:
 Behandlungszustand:
 Festigkeit: N/mm²
 Härte: Dehnung: %
 kurzspanend langspanend

Kühlung:

- Öl Emulsion % Trocken
 Umlauf Pinsel Nebel Sonstige:

Werkzeug-Empfehlung:

Ausführung:
 Artikel-Nr.:
 Schaftdurchmesser: DIN:
 Besonderheit:
 Bisher verwendete Werkzeuge (Hersteller):
 Standwert: (Anzahl der Gewinde)

Aufgenommen von:

Datum / Unterschrift:

- Product Finder
- V_c
- M
- MF
- UNC
- UNF
- G
- SELF-LOCK
- Tech. Info**

2.17 Technical questionnaire: Cold forming of threads

Company: Size:

Contact: Design:

Phone: Article no.:

Fax: Project:

E-mail:

Workpiece description: Thread hole diameter:

drilled broached stamped

cast drawn

Hole type (please enter dimensional specifications):

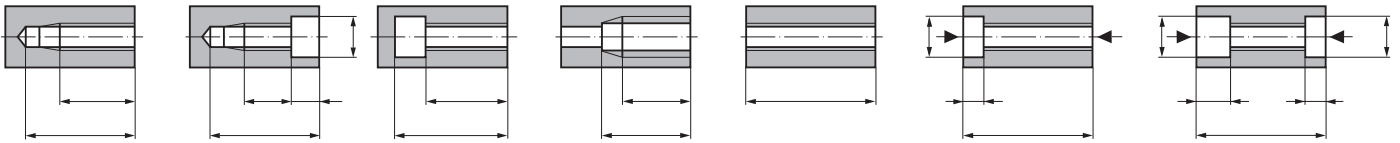

Machine:

Manufacturer:

Type:

Power: kW

horizontal rotating tool

vertical standing tool

Cutting data:

Speed n: rpm

Circumferential speed v_c: m/min

Feed:

Pressure cam Others:

Hydraulics

Lead screw

NC-controlled

Synchronous spindle

Gear wheels

Tool holder:

rigid (collet)

Tapping attachment } Manufacturer:

Tap holder } Type:

with overload clutch

with length compensation

with axial parallel floating

with internal coolant supply Pressure: bar

Spindle adaptation:

MT / ISO taper / HSK / TR / others:

DIN / ANSI / JIS / others:

Workpiece material:

Description:

Condition during work:

Tensile strength: N/mm²

Hardness: Elongation: %

short-chipping long-chipping

Cooling/lubrication:

Oil Emulsion % Dry

Circulation Brush Mist Others:

Tool recommendation:

Design:

Article no.:

Shank diameter: DIN:

Special features:

Tools used until now (manufacturer):

Tool life: (no. of threads)

Filled in by:

Date / signature:

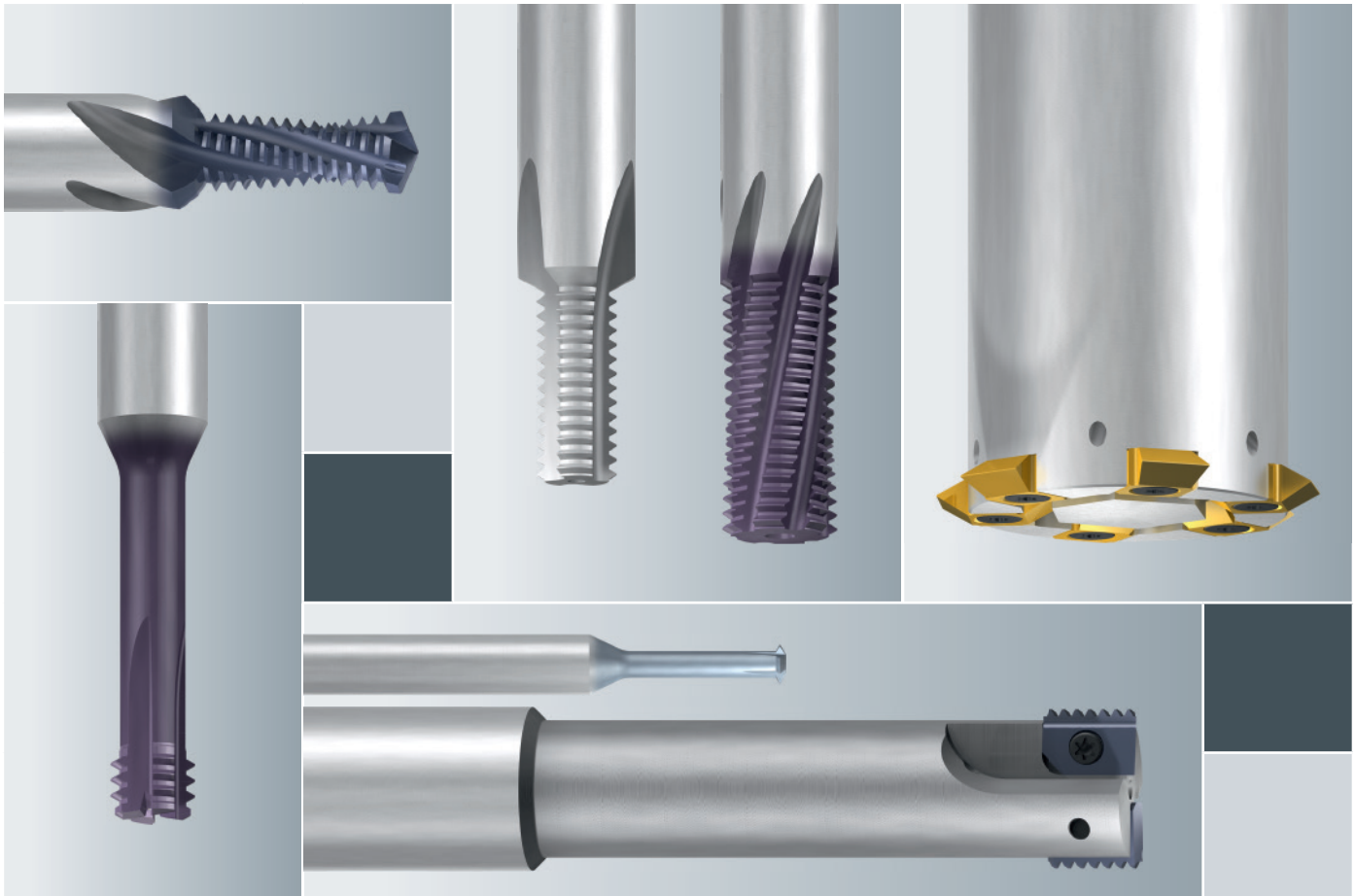

Gewindefräser Thread Milling Cutters

Seite · Page

Übersicht	Contents	326 - 327
Wegweiser und Schnittwerte	Product finder and cutting data	328 - 332
Produktseiten	Product pages	333 - 448
Technische Informationen	Technical information	449 - 472

Product Finder

 v_c / f_z

M

MF

 UNC
UN, UNS

 UNF
UNEF

G, Rp

 NPT, NPTF
Rc, W

BSW, BSF

Pg

 EG (STI)
SELF-LOCK

Tr

 Zubehör
Accessories

Tech. Info

BGF

ZBGF

GSF

GF

GF-KEG

ZGF

ZIRK-GF

Gigant

MoSys



BGF

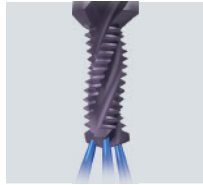

Vollhartmetall-Bohrgewindefräser

- Für die Komplettbearbeitung von Kernloch, Senkfase und Gewinde in einem Arbeitsgang
- Mit korrigiertem Gewindeprofil (abmessungsgebunden)

Solid carbide drill thread mills

- For the complete machining of thread hole, chamfer and thread in one work process
- With corrected thread profile (for one single thread size only)

333 - 352

ZBGF



Vollhartmetall-Zirkularbohrgewindefräser

- Für die Bearbeitung von Kernloch und Gewinde in einem Arbeitsgang
- Mit korrigiertem Gewindeprofil (abmessungsübergreifend, steigungsgebunden)

Solid carbide circular drill thread mills

- For the machining of thread hole and thread in one work process
- With corrected thread profile (for different thread sizes, but for one pitch only)

353 - 357

GSF



Vollhartmetall-Gewindefräser mit Senkfase

- Für die Bearbeitung von Senkfase und Gewinde in einem Arbeitsgang
- Mit korrigiertem Gewindeprofil (abmessungsgebunden)

Solid carbide thread milling cutters with countersinking step

- For the machining of countersunk edge and thread in one work process
- With corrected thread profile (for one single thread size only)

358 - 379

GSF-Z

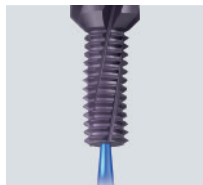

Vollhartmetall-Gewindefräser mit Senkfase

- Für die Bearbeitung von Senkfase und Gewinde in einem Arbeitsgang
- Mit korrigiertem Gewindeprofil (abmessungsgebunden)
- Hohe Nutenzahl
- Optimierte Schneidengeometrie

Solid carbide thread milling cutters with countersinking step

- For the machining of countersunk edge and thread in one work process
- With corrected thread profile (for one single thread size only)
- Increased number of flutes
- Optimised cutting geometry

GF



Vollhartmetall-Gewindefräser

- Mit Standard-Gewindeprofil (abmessungsübergreifend, steigungsgebunden)

Solid carbide thread milling cutters

- With standard thread profile (for different thread sizes, but for one pitch only)

GF-Z

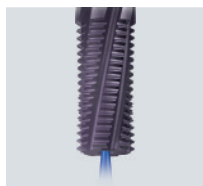

Vollhartmetall-Gewindefräser

- Mit Standard-Gewindeprofil (abmessungsübergreifend, steigungsgebunden)
- Hohe Nutenzahl
- Optimierte Schneidengeometrie

Solid carbide thread milling cutters

- With standard thread profile (for different thread sizes, but for one pitch only)
- Increased number of flutes
- Optimised cutting geometry

380 - 398

GF-Vario-Z

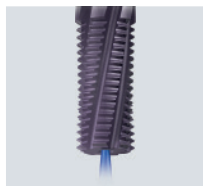

Vollhartmetall-Gewindefräser variabel

- Mit korrigiertem Gewindeprofil (abmessungsübergreifend, steigungsgebunden)
- Hohe Nutenzahl
- Optimierte Schneidengeometrie

Solid carbide thread milling cutters, variable

- With corrected thread profile (for different thread sizes, but for one pitch only)
- Increased number of flutes
- Optimised cutting geometry

GF-H

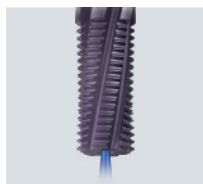

Vollhartmetall-Gewindefräser für die Hartbearbeitung

- Mit korrigiertem Gewindeprofil (abmessungsgebunden)

Solid carbide thread milling cutters for hard machining

- With corrected thread profile (for one single thread size only)

GF-KEG**Vollhartmetall-Gewindefräser für kegelige Gewinde**

- Mit korrigiertem Gewindeprofil (abmessungs- bzw. steigungsgebunden)

Solid carbide thread milling cutters for tapered threads

- With corrected thread profile (for one single thread size, resp. for one pitch only)

399 - 412

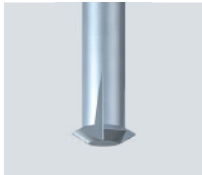
ZGF**Vollhartmetall-Zirkulargewindefräser**

- Mit korrigiertem Gewindeprofil (abmessungs- und steigungsübergreifend)
- Für die Bearbeitung von Gewinden ab M 1

Solid carbide circular thread milling cutters

- With corrected thread profile (for different thread sizes and pitches)
- For the machining of threads from M 1

ZGF-S-CUT**Vollhartmetall-Zirkulargewindefräser**

- Mit korrigiertem Gewindeprofil (abmessungsgebunden)

Solid carbide circular thread milling cutters

- With corrected thread profile (for one single thread size only)

413 - 420

ZGF-HCUT**Vollhartmetall-Zirkulargewindefräser**

- Mit korrigiertem Gewindeprofil (abmessungsgebunden)

Solid carbide circular thread milling cutters

- With corrected thread profile (for one single thread size only)

ZIRK-GF**Zirkular-Gewindefräskörper**

- Mit einer oder zwei Mehrzahnplatten (abmessungsübergreifend, steigungsgebunden)

Circular thread milling bodies

- With one or two multi-tooth inserts (for different thread sizes, but for one pitch only)

421 - 425

ZIRK-GF**Zirkular-Gewindefräskörper**

- Mit Einstechwendeplatte „3-Zahn“ (abmessungs- und steigungsübergreifend)

Circular thread milling bodies

- With infeed indexable insert "3-tooth" (for different thread sizes and pitches)

Gigant**Zirkular-Gewindefräskörper**

- Speziell für große Abmessungen
- Mit bis zu zehn 4-Zahn-Wendeplatten (abmessungs- und steigungsübergreifend)

Circular thread milling bodies

- Specially made for large thread sizes
- With up to ten 4-tooth indexable inserts (for different thread sizes and pitches)

426 - 445

MoSys**Kombinierbares Plan- und Stufsenk-System**

- Für die Komplettbearbeitung von z.B. Bohrung, Gewinde und Plansenkung

Counterbore and stepped bore system for free combination

- For the complete machining of thread hole, thread and spot face

446 - 448

v_c / f_z

M

MF

UNC
UN, UNSUNF
UNEF

G, Rp

NPT, NPTF
Rc, W

BSW, BSF

Pg

EG (STI)
SELF-LOCK

Tr

Zubehör
Accessories

Tech. Info

BGF

ZBGF

GSF

GF

GF-KEG

ZGF

ZIRK-GF

Gigant

MoSys



Wegweiser und Schnittwerte

Bitte beachten:

Die in den jeweiligen Spalten angegebenen Schnittwerte sind Richtwerte, welche je nach Einsatzbedingungen (Material, Schmierung, Maschine, usw.) angepasst werden müssen.

Die Eignung ist folgendermaßen gekennzeichnet:

- Gewindefräser sehr gut geeignet
- Gewindefräser gut geeignet

v_c = Schnittgeschwindigkeit [m/min]
 f_z = Vorschub pro Zahn [mm]
 f_b = Vorschub beim Bohren [mm/U]

Product finder and cutting data

Please note:

The cutting values listed in the respective columns are standard values which have to be adjusted to individual work conditions (material, lubrication, machine etc.).

The suitability is marked as follows:

- Thread milling cutter is very suitable
- Thread milling cutter is suitable

v_c = Cutting speed [m/min]
 f_z = Feed per tooth [mm]
 f_b = Drilling feed [mm/U]

Internationaler Werkstoffvergleich siehe Seite 838 - 851.

International comparison of materials, see page 838 - 851.

Einsatzgebiete – Material Applications – material		Material-Beispiele Material examples	Material-Nummern Material numbers	
P	Stahlwerkstoffe Kaltfließpressstähle, Baustähle, Automatenstähle, u.a.	Steel materials Cold-extrusion steels, Construction steels, Free-cutting steels, etc.	Cq15 1.1132 S235JR (St37-2) 1.0037 10SPb20 1.0722	
	2.1 Baustähle, Einsatzstähle, Stahlguss, u.a.	Construction steels, Cementation steels, Steel castings, etc.	E360 (St70-2) 1.0070 16MnCr5 1.7131 GS-25CrMo4 1.7218	
	3.1 Einsatzstähle, Vergütungsstähle, Kaltarbeitsstähle, u.a.	Cementation steels, Heat-treatable steels, Cold work steels, etc.	20MoCr3 1.7320 42CrMo4 1.7225 102Cr6 1.2067 50CrMo4 1.7228	
	4.1 Vergütungsstähle, Kaltarbeitsstähle, Nitrierstähle, u.a.	Heat-treatable steels, Cold work steels, Nitriding steels, etc.	X45NiCrMo4 1.2767 31CrMo12 1.8515 X38CrMoV5-3 1.2367	
	5.1 Hochlegierte Stähle, Kaltarbeitsstähle, Warmarbeitsstähle, u.a.	High-alloyed steels, Cold work steels, Hot work steels, etc.	X100CrMoV8-1-1 1.2990 X40CrMoV5-1 1.2344	
M	Nichtrostende Stahlwerkstoffe 1.1 Ferritisch, martensitisch 2.1 Austenitisch 3.1 Austenitisch-ferritisch (Duplex) 4.1 Austenitisch-ferritisch hitzebeständig (Super Duplex)	Stainless steel materials Ferritic, martensitic Austenitic Austenitic-ferritic (Duplex) Austenitic-ferritic heat-resistant (Super Duplex)	≤ 950 N/mm ² X2CrTi12 1.4512 ≤ 950 N/mm ² X6CrNiMoTi17-12-2 1.4571 ≤ 1100 N/mm ² X2CrNiMoN22-5-3 1.4462 ≤ 1250 N/mm ² X2CrNiMoN25-7-4 1.4410	
	Gusswerkstoffe 1.1 Gusseisen mit Lamellengrafit (GJL) 1.2 Gusseisen mit Kugelgrafit (GJS) 2.1 Gusseisen mit Kugelgrafit (GJS) 2.2 Gusseisen mit Kugelgrafit (GJS) 3.1 Gusseisen mit Vermiculargrafit (GJV) 3.2 Gusseisen mit Vermiculargrafit (GJV) 4.1 Temperguss (GTMW, GTMB) 4.2 Temperguss (GTMW, GTMB)	Cast materials Cast iron with lamellar graphite (GJL) Cast iron with nodular graphite (GJS) Cast iron with nodular graphite (GJS) Cast iron with vermicular graphite (GJV) Cast iron with vermicular graphite (GJV) Malleable cast iron (GTMW, GTMB) Malleable cast iron (GTMW, GTMB)	100-250 N/mm ² EN-GJL-200 (GG20) 250-450 N/mm ² EN-GJL-300 (GG30) 350-500 N/mm ² EN-GJS-400-15 (GGG40) 500-900 N/mm ² EN-GJS-700-2 (GGG70) 300-400 N/mm ² GJV 300 400-500 N/mm ² GJV 450 250-500 N/mm ² EN-GJMW-350-4 (GTW-35) 500-800 N/mm ² EN-GJMB-450-6 (GTS-45)	EN-JL-1030 EN-JL-1050 EN-JS-1030 EN-JS-1070 EN-JS-1070 EN-JM-1010 EN-JM-1140
	Nichteisenwerkstoffe 1.1 Aluminium-Legierungen 1.2 Aluminium-Knetlegierungen 1.3 Aluminium-Knetlegierungen 1.4 Aluminium-Knetlegierungen 1.5 Aluminium-Gusslegierungen 1.6 Aluminium-Gusslegierungen	Non ferrous materials Aluminium alloys Aluminium wrought alloys Aluminium wrought alloys Aluminium cast alloys	≤ 200 N/mm ² EN AW-AlMn1 EN AW-3103 ≤ 350 N/mm ² EN AW-AlMgSi EN AW-6060 ≤ 550 N/mm ² EN AW-AlZn5Mg3Cu EN AW-7022 Si ≤ 7% EN AC-AlMg5 EN AC-51300 7% < Si ≤ 12% EN AC-AISi9Cu3 EN AC-46500 12% < Si ≤ 17% GD-AISi17Cu4FeMg	EN AW-3103 EN AW-6060 EN AW-7022 EN AC-51300 EN AC-46500
	2.1 Kupfer-Legierungen 2.2 Reinkupfer, niedriglegiertes Kupfer 2.3 Kupfer-Zink-Legierungen (Messing, langspanend) 2.4 Kupfer-Zink-Legierungen (Messing, kurzspanend) 2.5 Kupfer-Aluminium-Legierungen (Alubronze, langspanend) 2.6 Kupfer-Aluminium-Legierungen (Alubronze, kurzspanend) 2.7 Kupfer-Zinn-Legierungen (Zinnbronze, langspanend) 2.8 Kupfer-Zinn-Legierungen (Zinnbronze, kurzspanend) 2.9 Kupfer-Sonderlegierungen	Copper alloys Pure copper, low-alloyed copper Copper-zinc alloys (brass, long-chipping) Copper-zinc alloys (brass, short-chipping) Copper-aluminium alloys (alu bronze, long-chipping) Copper-aluminium alloys (alu bronze, short-chipping) Copper-tin alloys (tin bronze, long-chipping) Copper-tin alloys (tin bronze, short-chipping) Special copper alloys	≤ 400 N/mm ² E-Cu 57 ≤ 550 N/mm ² CuZn37 (Ms63) ≤ 550 N/mm ² CuZn36Pb3 (Ms58) ≤ 800 N/mm ² CuAl10Ni5Fe4 ≤ 700 N/mm ² CuSn8P ≤ 400 N/mm ² CuSn7 ZnPb (Rg7) ≤ 600 N/mm ² (AMPCC® 8) ≤ 1400 N/mm ² (AMPCC® 45)	EN CW 004 A EN CW 508 L EN CW 603 N EN CW 307 G EN CW 459 K 2.1090
3.1 Magnesium-Legierungen 3.2 Magnesium-Knetlegierungen 3.3 Magnesium-Gusslegierungen	Magnesium alloys Magnesium wrought alloys Magnesium cast alloys	≤ 500 N/mm ² MgAl6Zn ≤ 500 N/mm ² EN-MCMgAl9Zn1	3.5612 EN-MC21120	
4.1 Kunststoffe 4.2 Duroplaste (kurzspanend) 4.3 Thermoplaste (langspanend) 4.4 Faserverstärkte Kunststoffe (Faseranteil ≤ 30%) 4.5 Faserverstärkte Kunststoffe (Faseranteil > 30%)	Synthetics Duroplastics (short-chipping) Thermoplastics (long-chipping) Fibre-reinforced synthetics (fibre content ≤ 30%) Fibre-reinforced synthetics (fibre content > 30%)	Bakelit, Pertinax PMMA, POM, PVC GFK, CFK, AFK GFK, CFK, AFK		
5.1 Besondere Werkstoffe 5.2 Grafit 5.3 Wolfram-Kupfer-Legierungen 5.4 Verbundwerkstoffe	Special materials Graphite Tungsten-copper alloys Composite materials	C 8000 W-Cu 80/20 Hylite, Alucobond		
S	Spezialwerkstoffe 1.1 Titan-Legierungen 1.2 Reintitan 1.3 Titan-Legierungen	Special materials Titanium alloys Pure titanium Titanium alloys	≤ 450 N/mm ² Ti1 3.7025 ≤ 900 N/mm ² TiAl6V4 3.7165 ≤ 1250 N/mm ² TiAl4Mo4Sn2 3.7185	
	2.1 Nickel-, Kobalt- und Eisen-Legierungen 2.2 Reinnickel 2.3 Nickel-Basis-Legierungen 2.4 Nickel-Basis-Legierungen 2.5 Kobalt-Basis-Legierungen 2.6 Eisen-Basis-Legierungen	Nickel alloys, cobalt alloys and iron alloys Pure nickel Nickel-base alloys Nickel-base alloys Cobalt-base alloys Iron-base alloys	≤ 600 N/mm ² Ni 99.6 2.4060 ≤ 1000 N/mm ² Monel 400 2.4360 ≤ 1600 N/mm ² Inconel 718 2.4668 ≤ 1000 N/mm ² Udimet 605 ≤ 1600 N/mm ² Haynes 25 2.4964 ≤ 1500 N/mm ² Incoloy 800 1.4958	
	1.1 Harte Werkstoffe 1.2 Hochfeste Stähle, gehärtete Stähle, Hartguss 1.3 Hochfeste Stähle, gehärtete Stähle, Hartguss 1.4 Hochfeste Stähle, gehärtete Stähle, Hartguss 1.5 Hochfeste Stähle, gehärtete Stähle, Hartguss	Hard materials High strength steels, hardened steels, hard castings	44 - 50 HRC Weldox 1100 50 - 55 HRC Hardox 550 55 - 60 HRC Armax 600T 60 - 63 HRC Ferro-Titanit 63 - 66 HRC HSSE	



GSF, GSF-Z



GF, GF-Z



GF-Vario-Z



GF-KEG



ZIRK-GF



GF-H

gerade- und 15° drallgenutet (R15)
straight flutes and 15° spiral flutes (R15)

30° drallgenutet (R30)
30° spiral flutes (R30)

v_c		v_c		f_z			v_c	f_z	
Unbeschichtet Uncoated	TICN	Unbeschichtet Uncoated	TICN	$\phi d_1 \leq 4 \text{ mm}$	$\phi d_1 \leq 8 \text{ mm}$	$\phi d_1 > 8 \text{ mm}$	TICN		
40 - 100	80 - 250	40 - 100	80 - 250	0,005 - 0,04	0,04 - 0,07	0,05 - 0,15			1.1
30 - 80	60 - 150	30 - 80	60 - 150	0,005 - 0,04	0,04 - 0,07	0,05 - 0,15			2.1
20 - 60	40 - 120	20 - 60	40 - 120	0,005 - 0,03	0,03 - 0,05	0,04 - 0,12			3.1
20 - 60	40 - 120			0,003 - 0,02	0,02 - 0,05	0,04 - 0,12			4.1
20 - 60	40 - 120			0,003 - 0,02	0,02 - 0,05	0,04 - 0,12			5.1
	40 - 120		40 - 120	0,003 - 0,03	0,03 - 0,05	0,04 - 0,12			1.1
	40 - 120		40 - 120	0,003 - 0,03	0,03 - 0,05	0,04 - 0,12			2.1
	30 - 80			0,003 - 0,02	0,02 - 0,05	0,04 - 0,10			3.1
	30 - 60			0,003 - 0,02	0,02 - 0,04	0,03 - 0,08			4.1
80 - 140	100 - 200	80 - 140	100 - 200		0,04 - 0,07	0,05 - 0,15			1.1
80 - 140	100 - 200	80 - 140	100 - 200		0,04 - 0,07	0,05 - 0,15			1.2
60 - 120	80 - 200	60 - 120	80 - 200		0,04 - 0,07	0,05 - 0,15			2.1
60 - 120	80 - 200	60 - 120	80 - 200		0,04 - 0,07	0,05 - 0,15			2.2
60 - 120	80 - 200	60 - 120	80 - 200		0,04 - 0,07	0,05 - 0,15			3.1
60 - 120	80 - 200	60 - 120	80 - 200		0,04 - 0,07	0,05 - 0,15			3.2
60 - 120	80 - 200	60 - 120	80 - 200		0,04 - 0,07	0,05 - 0,15			4.1
60 - 120	80 - 200	60 - 120	80 - 200		0,04 - 0,07	0,05 - 0,15			4.2
100 - 250	150 - 400	100 - 250	150 - 400	0,01 - 0,05	0,05 - 0,08	0,07 - 0,20			1.1
100 - 250	150 - 400	100 - 250	150 - 400	0,01 - 0,05	0,05 - 0,08	0,07 - 0,20			1.2
100 - 250	150 - 400	100 - 250	150 - 400	0,01 - 0,05	0,05 - 0,08	0,07 - 0,20			1.3
100 - 250	150 - 400	100 - 250	150 - 400	0,01 - 0,05	0,05 - 0,08	0,07 - 0,20			1.4
150 - 250	150 - 400	150 - 250	150 - 400	0,01 - 0,05	0,05 - 0,08	0,07 - 0,20			1.5
	100 - 200		100 - 200	0,01 - 0,05	0,05 - 0,08	0,07 - 0,20			1.6
100 - 250	150 - 400	100 - 250	150 - 400	0,008 - 0,05	0,05 - 0,08	0,07 - 0,20			2.1
100 - 250	150 - 400	100 - 250	150 - 400	0,008 - 0,05	0,05 - 0,08	0,07 - 0,20			2.2
100 - 250	150 - 400	100 - 250	150 - 400	0,008 - 0,05	0,05 - 0,08	0,07 - 0,20			2.3
60 - 150	100 - 250	60 - 150	100 - 250	0,008 - 0,04	0,04 - 0,07	0,05 - 0,15			2.4
60 - 150	100 - 250	60 - 150	100 - 250	0,008 - 0,04	0,04 - 0,07	0,05 - 0,15			2.5
60 - 150	100 - 250	60 - 150	100 - 250	0,008 - 0,04	0,04 - 0,07	0,05 - 0,15			2.6
80 - 200	100 - 250	80 - 200	100 - 250	0,008 - 0,04	0,04 - 0,07	0,05 - 0,15			2.7
	40 - 80		40 - 80	0,003 - 0,02	0,02 - 0,05	0,04 - 0,15	40 - 60	0,008 - 0,03	2.7
	30 - 60			0,003 - 0,02	0,02 - 0,05	0,04 - 0,15	40 - 60	0,008 - 0,03	2.8
150 - 250	150 - 400	150 - 250	150 - 400	0,01 - 0,05	0,05 - 0,08	0,07 - 0,20			3.1
150 - 250	150 - 400	150 - 250	150 - 400	0,01 - 0,05	0,05 - 0,08	0,07 - 0,20			3.2
60 - 150	100 - 400	60 - 150	100 - 400	0,01 - 0,05	0,05 - 0,10	0,08 - 0,25			4.1
60 - 150	100 - 400	60 - 150	100 - 400	0,01 - 0,05	0,05 - 0,10	0,08 - 0,25			4.2
	80 - 120		80 - 120	0,01 - 0,05	0,05 - 0,10	0,08 - 0,25			4.3
	80 - 120		80 - 120	0,01 - 0,05	0,05 - 0,10	0,08 - 0,25			4.4
	100 - 200		100 - 200		0,04 - 0,07	0,08 - 0,25			5.1
15 - 40	30 - 60	15 - 40	30 - 60		0,02 - 0,04	0,03 - 0,08			5.2
									5.3
15 - 50	30 - 80	15 - 50	30 - 80	0,003 - 0,03	0,03 - 0,05	0,04 - 0,10			1.1
15 - 50	30 - 80	15 - 50	30 - 80	0,003 - 0,03	0,03 - 0,05	0,04 - 0,10			1.2
15 - 40	30 - 60			0,003 - 0,02	0,02 - 0,04	0,03 - 0,08			1.3
	30 - 60		30 - 60	0,003 - 0,02	0,02 - 0,04	0,03 - 0,08			2.1
	30 - 60			0,003 - 0,02	0,02 - 0,04	0,03 - 0,08			2.2
	30 - 40			0,003 - 0,02	0,02 - 0,04	0,03 - 0,08			2.3
	30 - 60			0,003 - 0,02	0,02 - 0,04	0,03 - 0,08			2.4
	30 - 40			0,003 - 0,02	0,02 - 0,04	0,03 - 0,08			2.5
	30 - 40			0,003 - 0,02	0,02 - 0,04	0,03 - 0,08			2.6
	30 - 60				0,015 - 0,04	0,03 - 0,08			1.1
	30 - 60				0,015 - 0,04	0,03 - 0,08			1.2
							40 - 60	0,005 - 0,025	1.3
							30 - 40	0,005 - 0,015	1.4
							30 - 40	0,005 - 0,015	1.5

Product Finder

v_c / f_z

M

MF

UNC
UN, UNS

UNF
UNEF

G, Rp

NPT, NPTF
Rc, W

BSW, BSF

Pg

EG (STI)
SELF-LOCK

Tr

Zubehör
Accessories

Tech. Info

BGF

ZBGF

GSF

GF

GF-KEG

ZGF

ZIRK-GF

Gigant

MoSys

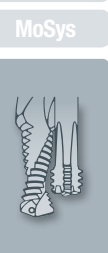

BGF-Z2



BGF-Z3



BGF-Z4

		v_c		v_c		v_c		f_b		f_z	
		Unbeschichtet Uncoated	TICN	Unbeschichtet Uncoated	TICN	TICN	TIALN-T3	$\varnothing d_1 \leq 8 \text{ mm}$	$\varnothing d_1 > 8 \text{ mm}$	$\varnothing d_1 \leq 8 \text{ mm}$	$\varnothing d_1 > 8 \text{ mm}$
P	1.1										
	2.1										
	3.1										
	4.1										
	5.1										
M	1.1										
	2.1										
	3.1										
	4.1										
K	1.1	80 - 140	80 - 160	80 - 140	80 - 160	80 - 160	80 - 160	0,10 - 0,25	0,20 - 0,40	0,04 - 0,07	0,05 - 0,12
	1.2	80 - 140	80 - 160	80 - 140	80 - 160	80 - 160	80 - 160	0,10 - 0,25	0,20 - 0,40	0,04 - 0,07	0,05 - 0,12
	2.1	80 - 140	80 - 160					0,10 - 0,15	0,15 - 0,25	0,04 - 0,07	0,05 - 0,12
	2.2	80 - 140	80 - 160					0,10 - 0,15	0,15 - 0,25	0,04 - 0,07	0,05 - 0,12
	3.1	80 - 140	80 - 160					0,10 - 0,25	0,20 - 0,40	0,04 - 0,07	0,05 - 0,12
	3.2	80 - 140	80 - 160					0,10 - 0,25	0,20 - 0,40	0,04 - 0,07	0,05 - 0,12
	4.1										
	4.2										
N	1.1	100 - 250	150 - 250					0,08 - 0,15	0,15 - 0,25	0,04 - 0,08	0,07 - 0,15
	1.2	100 - 250	150 - 250					0,08 - 0,15	0,15 - 0,25	0,04 - 0,08	0,07 - 0,15
	1.3	100 - 250	150 - 250					0,08 - 0,15	0,15 - 0,25	0,04 - 0,08	0,07 - 0,15
	1.4	100 - 250	150 - 400					0,15 - 0,25	0,20 - 0,40	0,04 - 0,08	0,07 - 0,15
	1.5	100 - 250	150 - 400	100 - 250	150 - 400	150 - 400	150 - 400	0,15 - 0,25	0,20 - 0,40	0,04 - 0,08	0,07 - 0,15
	1.6		100 - 200		100 - 200	100 - 200	100 - 200	0,15 - 0,25	0,20 - 0,40	0,04 - 0,08	0,07 - 0,15
	2.1										
	2.2	100 - 250	150 - 400					0,10 - 0,20	0,15 - 0,30	0,05 - 0,08	0,07 - 0,15
	2.3	100 - 250	150 - 400	100 - 250	150 - 400	150 - 400	150 - 400	0,10 - 0,20	0,15 - 0,30	0,05 - 0,08	0,07 - 0,15
	2.4										
	2.5										
	2.6	80 - 200	100 - 250					0,10 - 0,25	0,20 - 0,40	0,04 - 0,07	0,05 - 0,12
	2.7										
	2.8										
	3.1	100 - 250	150 - 400					0,10 - 0,20	0,15 - 0,30	0,04 - 0,08	0,07 - 0,15
	3.2	100 - 250	150 - 400					0,15 - 0,30	0,20 - 0,40	0,04 - 0,08	0,07 - 0,15
4.1	60 - 150	100 - 400					0,15 - 0,30	0,20 - 0,40	0,05 - 0,10	0,08 - 0,20	
4.2											
4.3											
4.4											
5.1											
5.2											
5.3											
S	1.1										
	1.2										
	1.3										
	2.1										
	2.2										
	2.3										
	2.4										
2.5											
2.6											
H	1.1										
	1.2										
	1.3										
	1.4										
	1.5										



ZGF



ZGF-S-CUT



ZGF-HCUT

	v_c		f_z			v_c	f_z	
	Unbeschichtet Uncoated	TiCN	$\varnothing d_1 \leq 4 \text{ mm}$	$\varnothing d_1 \leq 8 \text{ mm}$	$\varnothing d_1 > 8 \text{ mm}$			
40 - 100	80 - 250		0,005 - 0,04	0,04 - 0,07	0,05 - 0,15			1.1
30 - 80	60 - 150		0,005 - 0,04	0,04 - 0,07	0,05 - 0,15			2.1
20 - 60	40 - 120		0,005 - 0,03	0,03 - 0,05	0,04 - 0,12			3.1
20 - 60	40 - 120		0,003 - 0,02	0,02 - 0,05	0,04 - 0,12			4.1
20 - 60	40 - 120		0,003 - 0,02	0,02 - 0,05	0,04 - 0,12			5.1
	40 - 120		0,003 - 0,03	0,03 - 0,05	0,04 - 0,12			1.1
	40 - 120		0,003 - 0,03	0,03 - 0,05	0,04 - 0,12			2.1
	30 - 80		0,003 - 0,02	0,02 - 0,05	0,04 - 0,10			3.1
	30 - 60		0,003 - 0,02	0,02 - 0,04	0,03 - 0,08			4.1
80 - 140	100 - 200			0,04 - 0,07	0,05 - 0,15			1.1
80 - 140	100 - 200			0,04 - 0,07	0,05 - 0,15			1.2
60 - 120	80 - 200			0,04 - 0,07	0,05 - 0,15			2.1
60 - 120	80 - 200			0,04 - 0,07	0,05 - 0,15			2.2
60 - 120	80 - 200			0,04 - 0,07	0,05 - 0,15			3.1
60 - 120	80 - 200			0,04 - 0,07	0,05 - 0,15			3.2
60 - 120	80 - 200			0,04 - 0,07	0,05 - 0,15			4.1
60 - 120	80 - 200			0,04 - 0,07	0,05 - 0,15			4.2
100 - 250	150 - 400		0,01 - 0,05	0,05 - 0,08	0,07 - 0,20			1.1
100 - 250	150 - 400		0,01 - 0,05	0,05 - 0,08	0,07 - 0,20			1.2
100 - 250	150 - 400		0,01 - 0,05	0,05 - 0,08	0,07 - 0,20			1.3
150 - 250	150 - 400		0,01 - 0,05	0,05 - 0,08	0,07 - 0,20			1.4
150 - 250	150 - 400		0,01 - 0,05	0,05 - 0,08	0,07 - 0,20			1.5
	100 - 200		0,01 - 0,05	0,05 - 0,08	0,07 - 0,20			1.6
100 - 250	150 - 400		0,008 - 0,05	0,05 - 0,08	0,07 - 0,20			2.1
100 - 250	150 - 400		0,008 - 0,05	0,05 - 0,08	0,07 - 0,20			2.2
100 - 250	150 - 400		0,008 - 0,05	0,05 - 0,08	0,07 - 0,20			2.3
60 - 150	100 - 250		0,008 - 0,04	0,04 - 0,07	0,05 - 0,15			2.4
60 - 150	100 - 250		0,008 - 0,04	0,04 - 0,07	0,05 - 0,15			2.5
60 - 150	100 - 250		0,008 - 0,04	0,04 - 0,07	0,05 - 0,15			2.6
80 - 200	100 - 250		0,008 - 0,04	0,04 - 0,07	0,05 - 0,15			2.7
	40 - 80		0,003 - 0,02	0,02 - 0,05	0,04 - 0,15			2.7
	30 - 60		0,003 - 0,02	0,02 - 0,05	0,04 - 0,15			2.8
150 - 250	150 - 400		0,01 - 0,05	0,05 - 0,08	0,07 - 0,20			3.1
150 - 250	150 - 400		0,01 - 0,05	0,05 - 0,08	0,07 - 0,20			3.2
60 - 150	100 - 400		0,01 - 0,05	0,05 - 0,10	0,08 - 0,25			4.1
60 - 150	100 - 400		0,01 - 0,05	0,05 - 0,10	0,08 - 0,25			4.2
	80 - 120		0,01 - 0,05	0,05 - 0,10	0,08 - 0,25			4.3
	80 - 120		0,01 - 0,05	0,05 - 0,10	0,08 - 0,25			4.4
	100 - 200			0,04 - 0,07	0,08 - 0,25			5.1
	30 - 60			0,02 - 0,04	0,03 - 0,08			5.2
								5.3
15 - 50	30 - 80		0,003 - 0,03	0,03 - 0,05	0,04 - 0,10			1.1
15 - 50	30 - 80		0,003 - 0,03	0,03 - 0,05	0,04 - 0,10			1.2
15 - 40	30 - 60		0,003 - 0,02	0,02 - 0,04	0,03 - 0,08			1.3
								2.1
								2.2
								2.3
								2.4
								2.5
								2.6
								1.1
						30 - 60	0,005 - 0,08	1.2
						30 - 60	0,005 - 0,08	1.3
						30 - 60	0,005 - 0,06	1.4
						30 - 60	0,005 - 0,06	1.5

Product Finder

v_c / f_z

M

MF

UNC
UN, UNS

UNF
UNEF

G, Rp

NPT, NPTF
Rc, W

BSW, BSF

Pg

EG (STI)
SELF-LOCK

Tr

Zubehör
Accessories

Tech. Info

BGF

ZBGF

GSF

GF

GF-KEG

ZGF

ZIRK-GF

Gigant

MoSys



ZBGF-T



ZBGF-W



ZBGF-H



Gigant

		v_c	f_z	v_c	f_z	v_c	f_z	v_c	f_z
		Beschichtet Coated		Beschichtet Coated		Beschichtet Coated		Beschichtet Coated	
P	1.1			150 - 250	0,04 - 0,08			250 - 500	0,15 - 0,25
	2.1			150 - 250	0,04 - 0,08			250 - 500	0,15 - 0,25
	3.1			100 - 250	0,03 - 0,08			150 - 250	0,10 - 0,15
	4.1			100 - 250	0,03 - 0,08			150 - 250	0,10 - 0,15
	5.1			100 - 200	0,02 - 0,06			150 - 250	0,10 - 0,15
M	1.1			100 - 180	0,02 - 0,05			80 - 150	0,10 - 0,15
	2.1			100 - 180	0,02 - 0,05			80 - 150	0,10 - 0,15
	3.1			60 - 120	0,02 - 0,04			60 - 120	0,08 - 0,12
	4.1			60 - 120	0,02 - 0,04			60 - 120	0,08 - 0,12
K	1.1	200 - 300	0,04 - 0,12	200 - 300	0,04 - 0,10			180 - 400	0,15 - 0,25
	1.2	200 - 300	0,04 - 0,12	200 - 300	0,04 - 0,10			180 - 400	0,15 - 0,25
	2.1			150 - 250	0,05 - 0,08			180 - 400	0,15 - 0,25
	2.2			150 - 250	0,05 - 0,08			180 - 400	0,15 - 0,25
	3.1			150 - 250	0,05 - 0,08			150 - 250	0,10 - 0,15
	3.2			150 - 250	0,05 - 0,08			150 - 250	0,10 - 0,15
	4.1			200 - 300	0,05 - 0,10			180 - 400	0,15 - 0,25
	4.2			200 - 300	0,05 - 0,10			180 - 400	0,15 - 0,25
N	1.1	200 - 300	0,04 - 0,08	200 - 300	0,05 - 0,10			400 - 500	0,15 - 0,30
	1.2	200 - 300	0,04 - 0,08	200 - 300	0,05 - 0,10			400 - 500	0,15 - 0,30
	1.3	200 - 300	0,04 - 0,08	200 - 300	0,05 - 0,10			400 - 500	0,15 - 0,30
	1.4	200 - 300	0,04 - 0,08	200 - 300	0,05 - 0,10			400 - 500	0,15 - 0,30
	1.5	200 - 300	0,04 - 0,10	200 - 300	0,05 - 0,10			400 - 500	0,15 - 0,30
	1.6	100 - 200	0,04 - 0,10	100 - 200	0,05 - 0,10			150 - 250	0,15 - 0,30
	2.1			100 - 180	0,03 - 0,05			250 - 500	0,15 - 0,25
	2.2			150 - 250	0,05 - 0,08			250 - 500	0,15 - 0,25
	2.3			200 - 300	0,05 - 0,10			250 - 500	0,15 - 0,25
	2.4			100 - 180	0,03 - 0,05			150 - 250	0,10 - 0,25
	2.5			100 - 180	0,03 - 0,05			150 - 250	0,10 - 0,25
	2.6			200 - 300	0,05 - 0,10			150 - 250	0,10 - 0,25
	2.7					40 - 60	0,02 - 0,04	80 - 150	0,10 - 0,15
	2.8					40 - 60	0,02 - 0,04	80 - 150	0,10 - 0,15
	3.1	200 - 300	0,04 - 0,10	200 - 300	0,05 - 0,10			400 - 500	0,15 - 0,30
	3.2	200 - 300	0,04 - 0,10	200 - 300	0,05 - 0,10			400 - 500	0,15 - 0,30
	4.1			150 - 250	0,05 - 0,08			180 - 400	0,15 - 0,25
	4.2							180 - 400	0,15 - 0,25
	4.3			80 - 150	0,05 - 0,08			80 - 150	0,15 - 0,25
	4.4			80 - 150	0,05 - 0,08			80 - 150	0,15 - 0,25
5.1									
5.2									
5.3									
S	1.1			60 - 120	0,02 - 0,04			60 - 120	0,08 - 0,12
	1.2			60 - 120	0,02 - 0,04			60 - 120	0,08 - 0,12
	1.3			60 - 120	0,02 - 0,04			60 - 120	0,08 - 0,12
	2.1			60 - 120	0,02 - 0,04				
	2.2			60 - 120	0,02 - 0,04				
	2.3								
H	1.1			60 - 100	0,02 - 0,06	60 - 100	0,03 - 0,06		
	1.2			60 - 100	0,02 - 0,06	60 - 100	0,03 - 0,06		
	1.3					40 - 70	0,02 - 0,04		
	1.4					30 - 60	0,02 - 0,04		
	1.5					30 - 60	0,02 - 0,04		

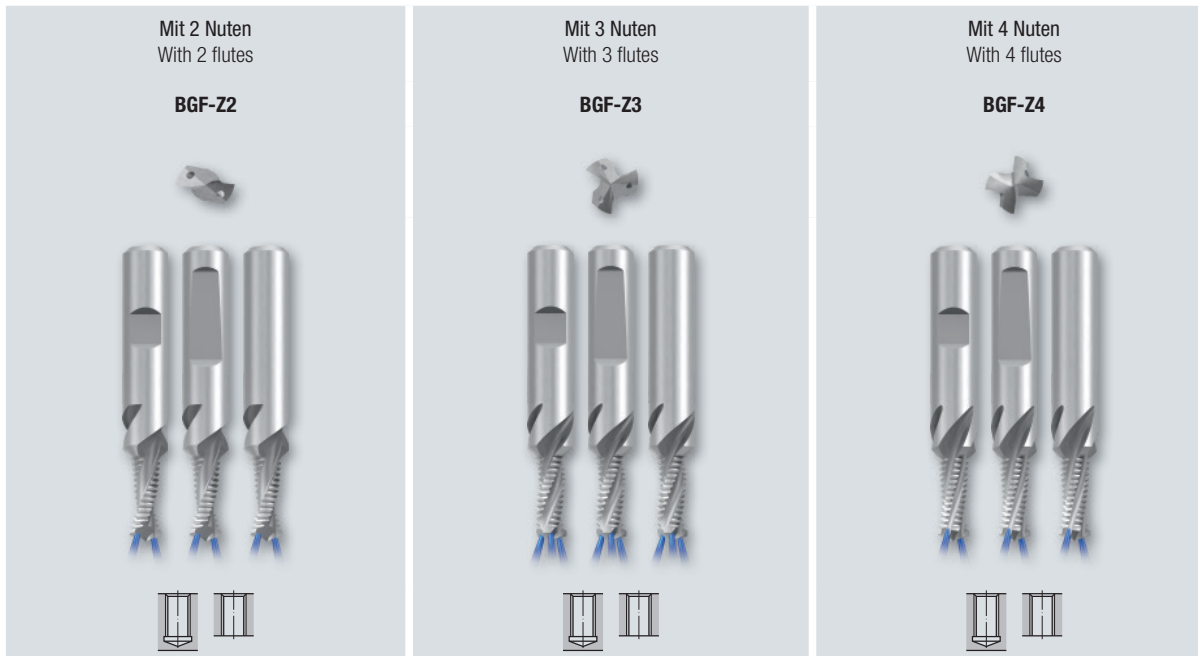

Seite · Page

334 - 335	336 - 337	338 - 339	M
340 - 341		342 - 343	MF
344 - 345			UNC
346 - 347			UNF
348 - 349			G (BSP)
350 - 351			EG M (STI)

Product Finder

- v_c / f_z
- M
- MF
- UNC
UN, UNS
- UNF
UNEF
- G, Rp
- NPT, NPTF
Rc, W
- BSW, BSF
- Pg
- EG (STI)
SELF-LOCK
- Tr

Zubehör
Accessories

Tech. Info

BGF

ZBGF

GSF

GF

GF-KEG

ZGF

ZIRK-GF

Gigant

MoSys



Mögliche Modifikationen · Possible modifications



Stirrfase am Bohrteil
Face chamfer on the drill part



AZR/AZ (ausgesetzte Zähne)
AZR/AZ (alternating teeth)



Unvollständigen Gang entfernen
Remove incomplete thread



Schaftkühlruten
Coolant grooves along the shank

Eine Beschreibung dieser Modifikationsmöglichkeiten finden Sie auf Seite 456 - 457
For a description of these modifications, see pages 456 - 457

Gewindefräszyklus · Thread milling cycle

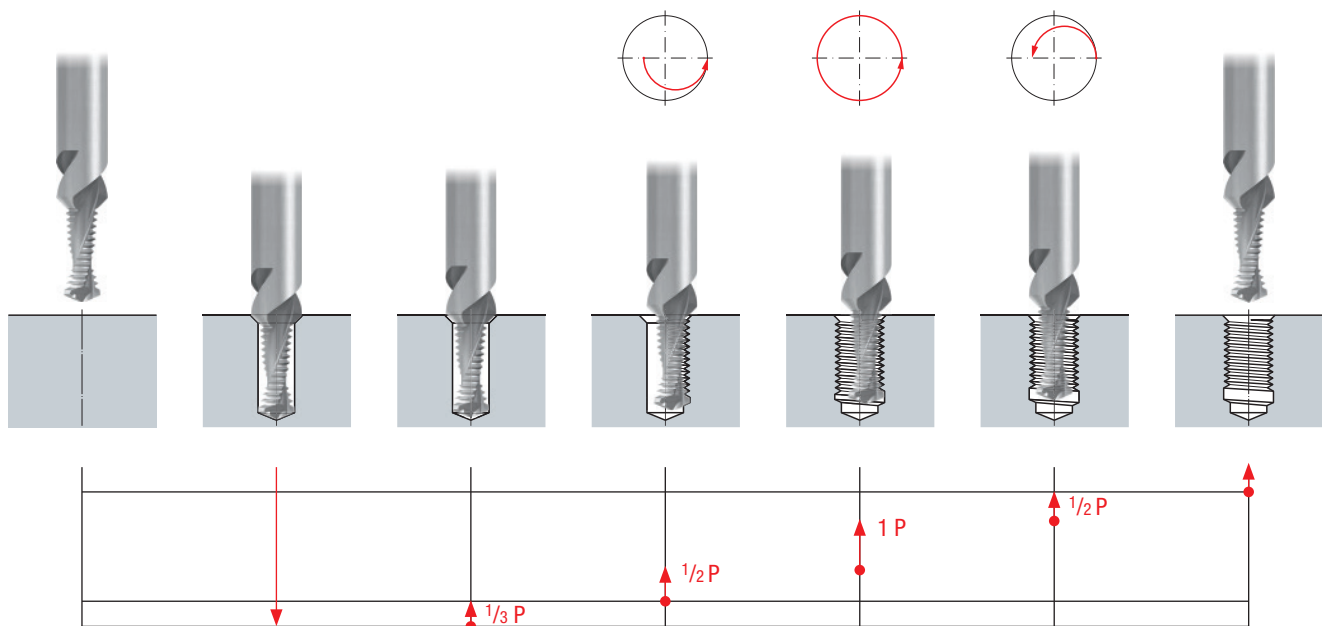

- Product Finder
- v_c / f_z
- M
- MF
- UNC UN, UNS
- UNF UNEF
- G, Rp
- NPT, NPTF Rc, W
- BSW, BSF
- Pg
- EG (STI) SELF-LOCK
- Tr
- Zubehör Accessories
- Tech. Info
- BGF
- ZBGF
- GSF
- GF
- GF-KEG
- ZGF
- ZIRK-GF
- Gigant
- MoSys

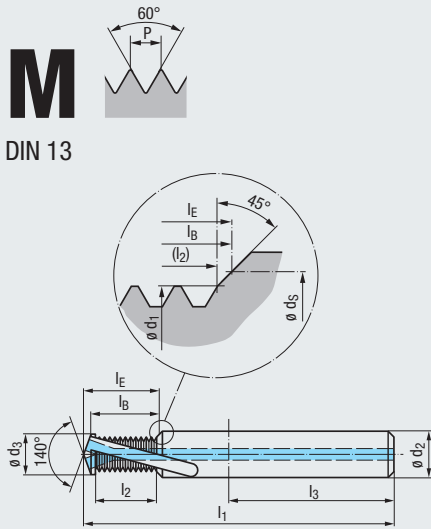

VHM

R30 **RH + LH**

Z2 **DIN 6535**
 HB
 HE
 HA

90° **Ø D**

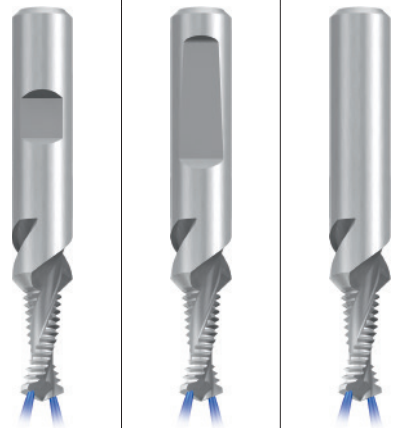

Einsatzgebiete – Material Applications – material **328**

K 1.1-3.2 **N 1.1-5**
N 2.2-3, 2.6 **N 3.1-2, 4.1**

Gewindetiefe Thread depth

1,5 x D

Werkzeug-Ident · Tool ident												GF422201	GF422501	GF422801
												BGF-VHM-Z2 1,5xD R30-IKZ-HB	BGF-VHM-Z2 1,5xD R30-IKZ-HE	BGF-VHM-Z2 1,5xD R30-IKZ-HA
Ø D mm	P mm	l ₁	l ₂	l ₃	Ø d ₁	Ø d ₂	Ø d ₃	Ø d _S	l _B	l _E	Dimens.- Ident			
M 4	0,7	49	5,64	36	3,16	6	3,3	4,3	6,8	7,4	.0040	●	●	●
5	0,8	55	7,25	36	4,04	6	4,2	5,3	8,6	9,4	.0050	●	●	●
6	1	62	9,06	36	4,8	8	5	6,3	10,7	11,6	.0060	●	●	●
8	1,25	74	11,33	40	6,5	10	6,75	8,3	13,4	14,6	.0080	●	●	●
10	1,5	79	15,09	45	8,2	12	8,5	10,3	17,5	19,1	.0100	●	●	●
12	1,75	89	17,61	45	9,9	14	10,25	12,3	20,4	22,3	.0112	●	●	●
14	2	102	20,12	48	11,6	16	12	14,3	23,3	25,5	.0114	●	●	●
16	2	102	24,13	48	13,6	18	14	16,3	27,3	29,9	.0116	●	●	●

Gewindetiefe Thread depth

2 x D

Werkzeug-Ident · Tool ident												GF432201	GF432501	GF432801
												BGF-VHM-Z2 2xD R30-IKZ-HB	BGF-VHM-Z2 2xD R30-IKZ-HE	BGF-VHM-Z2 2xD R30-IKZ-HA
Ø D mm	P mm	l ₁	l ₂	l ₃	Ø d ₁	Ø d ₂	Ø d ₃	Ø d _S	l _B	l _E	Dimens.- Ident			
M 4	0,7	49	7,74	36	3,16	6	3,3	4,3	8,9	9,5	.0040	●	●	●
5	0,8	55	9,65	36	4,04	6	4,2	5,3	11	11,8	.0050	●	●	●
6	1	62	12,06	36	4,8	8	5	6,3	13,7	14,6	.0060	●	●	●
8	1,25	74	15,08	40	6,5	10	6,75	8,3	17,1	18,3	.0080	●	●	●
10	1,5	79	19,59	45	8,2	12	8,5	10,3	22	23,6	.0100	●	●	●
12	1,75	89	22,86	45	9,9	14	10,25	12,3	25,7	27,5	.0112	●	●	●
14	2	102	28,12	48	11,6	16	12	14,3	31,3	33,5	.0114	●	●	●
16	2	102	32,13	48	13,6	18	14	16,3	35,3	37,9	.0116	●	●	●

Gewindetiefe Thread depth

2,5 x D

Werkzeug-Ident · Tool ident												GF442201	GF442501	GF442801
												BGF-VHM-Z2 2,5xD R30-IKZ-HB	BGF-VHM-Z2 2,5xD R30-IKZ-HE	BGF-VHM-Z2 2,5xD R30-IKZ-HA
Ø D mm	P mm	l ₁	l ₂	l ₃	Ø d ₁	Ø d ₂	Ø d ₃	Ø d _S	l _B	l _E	Dimens.- Ident			
M 6	1	65	15,10	36	4,8	8	5	6,3	16,7	17,6	.0060	●	●	●
8	1,25	80	20,08	40	6,5	10	6,75	8,3	22,1	23,3	.0080	●	●	●
10	1,5	85	25,59	45	8,2	12	8,5	10,3	28	29,6	.0100	●	●	●
12	1,75	95	29,86	45	9,9	14	10,25	12,3	32,7	34,5	.0112	●	●	●
14	2	110	36,12	48	11,6	16	12	14,3	39,3	41,5	.0114	●	●	●
16	2	110	40,13	48	13,6	18	14	16,3	43,3	45,9	.0116	●	●	●

Andere Abmessungen auf Anfrage
 Other sizes upon request

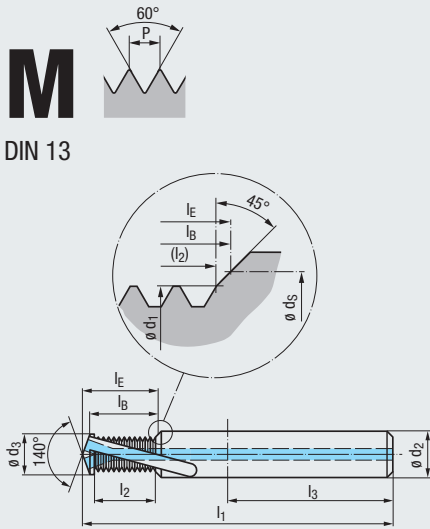

VHM	TICN
R30	RH + LH
Z2	DIN 6535 HB HE HA
90°	ø D

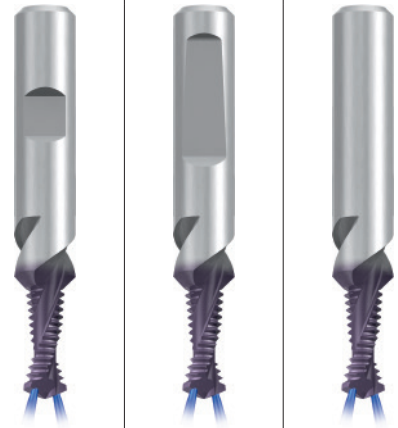

Einsatzgebiete – Material Applications – material ▶▶ 328

K 1.1-3.2 **N** 1.1-6
N 2.2-3, 2.6 **N** 3.1-2, 4.1

Gewindetiefe Thread depth

1,5 x D

Werkzeug-Ident · Tool ident

ø D mm	P mm	l ₁	l ₂	l ₃	ø d ₁	ø d ₂	ø d ₃	ø d _S	l _B	l _E	Dimens.- Ident	GF422206	GF422506	GF422806
												BGF-VHM-Z2 1,5xD R30-1KZ-HB TICN	BGF-VHM-Z2 1,5xD R30-1KZ-HE TICN	BGF-VHM-Z2 1,5xD R30-1KZ-HA TICN
M 4	0,7	49	5,64	36	3,16	6	3,3	4,3	6,8	7,4	.0040	●	●	●
5	0,8	55	7,25	36	4,04	6	4,2	5,3	8,6	9,4	.0050	●	●	●
6	1	62	9,06	36	4,8	8	5	6,3	10,7	11,6	.0060	●	●	●
8	1,25	74	11,33	40	6,5	10	6,75	8,3	13,4	14,6	.0080	●	●	●
10	1,5	79	15,09	45	8,2	12	8,5	10,3	17,5	19,1	.0100	●	●	●
12	1,75	89	17,61	45	9,9	14	10,25	12,3	20,4	22,3	.0112	●	●	●
14	2	102	20,12	48	11,6	16	12	14,3	23,3	25,5	.0114	●	●	●
16	2	102	24,13	48	13,6	18	14	16,3	27,3	29,9	.0116	●	●	●

Gewindetiefe Thread depth

2 x D

Werkzeug-Ident · Tool ident

ø D mm	P mm	l ₁	l ₂	l ₃	ø d ₁	ø d ₂	ø d ₃	ø d _S	l _B	l _E	Dimens.- Ident	GF432206	GF432506	GF432806
												BGF-VHM-Z2 2xD R30-1KZ-HB TICN	BGF-VHM-Z2 2xD R30-1KZ-HE TICN	BGF-VHM-Z2 2xD R30-1KZ-HA TICN
M 4	0,7	49	7,74	36	3,16	6	3,3	4,3	8,9	9,5	.0040	●	●	●
5	0,8	55	9,65	36	4,04	6	4,2	5,3	11	11,8	.0050	●	●	●
6	1	62	12,06	36	4,8	8	5	6,3	13,7	14,6	.0060	●	●	●
8	1,25	74	15,08	40	6,5	10	6,75	8,3	17,1	18,3	.0080	●	●	●
10	1,5	79	19,59	45	8,2	12	8,5	10,3	22	23,6	.0100	●	●	●
12	1,75	89	22,86	45	9,9	14	10,25	12,3	25,7	27,5	.0112	●	●	●
14	2	102	28,12	48	11,6	16	12	14,3	31,3	33,5	.0114	●	●	●
16	2	102	32,13	48	13,6	18	14	16,3	35,3	37,9	.0116	●	●	●

Gewindetiefe Thread depth

2,5 x D

Werkzeug-Ident · Tool ident

ø D mm	P mm	l ₁	l ₂	l ₃	ø d ₁	ø d ₂	ø d ₃	ø d _S	l _B	l _E	Dimens.- Ident	GF442206	GF442506	GF442806
												BGF-VHM-Z2 2,5xD R30-1KZ-HB TICN	BGF-VHM-Z2 2,5xD R30-1KZ-HE TICN	BGF-VHM-Z2 2,5xD R30-1KZ-HA TICN
M 6	1	65	15,10	36	4,8	8	5	6,3	16,7	17,6	.0060	●	●	●
8	1,25	80	20,08	40	6,5	10	6,75	8,3	22,1	23,3	.0080	●	●	●
10	1,5	85	25,59	45	8,2	12	8,5	10,3	28	29,6	.0100	●	●	●
12	1,75	95	29,86	45	9,9	14	10,25	12,3	32,7	34,5	.0112	●	●	●
14	2	110	36,12	48	11,6	16	12	14,3	39,3	41,5	.0114	●	●	●
16	2	110	40,13	48	13,6	18	14	16,3	43,3	45,9	.0116	●	●	●

Andere Abmessungen auf Anfrage
Other sizes upon request



- Product Finder
- v_c / f_z
- M
- MF
- UNC UN, UNS
- UNF UNEF
- G, Rp
- NPT, NPTF Rc, W
- BSW, BSF
- Pg
- EG (STI) SELF-LOCK
- Tr
- Zubehör Accessories
- Tech. Info
- BGF
- ZBGF
- GSF
- GF
- GF-KEG
- ZGF
- ZIRK-GF
- Gigant
- MoSys

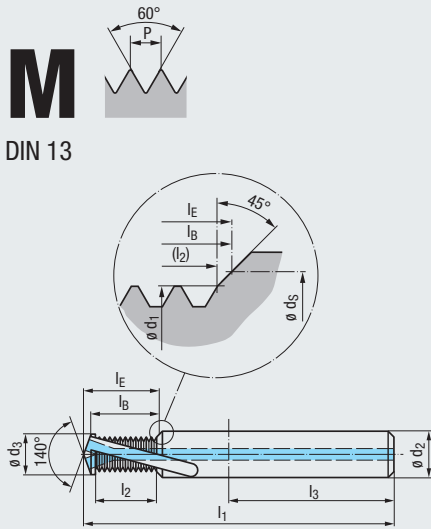

VHM

R30 **RH + LH**

Z3 **DIN 6535**
 HB
 HE
 HA

90° **Ø D**

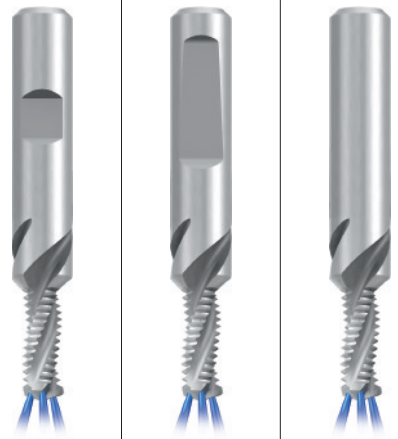

Einsatzgebiete – Material Applications – material **328**

K 1.1-2 **N 1.5, 2, 3**

Gewindetiefe Thread depth												1,5 x D		
Werkzeug-Ident · Tool ident												GF422251	GF422551	GF422851
											Dimens.-Ident	BGF-VHM-Z3 1,5xD R30-IKZ-HB	BGF-VHM-Z3 1,5xD R30-IKZ-HE	BGF-VHM-Z3 1,5xD R30-IKZ-HA
Ø D mm	P mm	l ₁	l ₂	l ₃	Ø d ₁	Ø d ₂	Ø d ₃	Ø d _S	l _B	l _E				
M 6	1	62	9,06	36	4,8	8	5	6,3	10,7	11,6	.0060	●	●	●
8	1,25	74	11,33	40	6,5	10	6,75	8,3	13,4	14,6	.0080	●	●	●
10	1,5	79	15,09	45	8,2	12	8,5	10,3	17,5	19,1	.0100	●	●	●
12	1,75	89	17,61	45	9,9	14	10,25	12,3	20,4	22,3	.0112	●	●	●
16	2	102	24,13	48	13,6	18	14	16,3	27,3	29,9	.0116	●	●	●

Gewindetiefe Thread depth												2 x D		
Werkzeug-Ident · Tool ident												GF432251	GF432551	GF432851
											Dimens.-Ident	BGF-VHM-Z3 2xD R30-IKZ-HB	BGF-VHM-Z3 2xD R30-IKZ-HE	BGF-VHM-Z3 2xD R30-IKZ-HA
Ø D mm	P mm	l ₁	l ₂	l ₃	Ø d ₁	Ø d ₂	Ø d ₃	Ø d _S	l _B	l _E				
M 6	1	62	12,06	36	4,8	8	5	6,3	13,7	14,6	.0060	●	●	●
8	1,25	74	15,08	40	6,5	10	6,75	8,3	17,1	18,3	.0080	●	●	●
10	1,5	79	19,59	45	8,2	12	8,5	10,3	22	23,6	.0100	●	●	●
12	1,75	89	22,86	45	9,9	14	10,25	12,3	25,7	27,5	.0112	●	●	●
16	2	102	32,13	48	13,6	18	14	16,3	35,3	37,9	.0116	●	●	●

Gewindetiefe Thread depth												2,5 x D		
Werkzeug-Ident · Tool ident												GF442251	GF442551	GF442851
											Dimens.-Ident	BGF-VHM-Z3 2,5xD R30-IKZ-HB	BGF-VHM-Z3 2,5xD R30-IKZ-HE	BGF-VHM-Z3 2,5xD R30-IKZ-HA
Ø D mm	P mm	l ₁	l ₂	l ₃	Ø d ₁	Ø d ₂	Ø d ₃	Ø d _S	l _B	l _E				
M 6	1	65	15,10	36	4,8	8	5	6,3	16,7	17,6	.0060	●	●	●
8	1,25	80	20,08	40	6,5	10	6,75	8,3	22,1	23,3	.0080	●	●	●
10	1,5	85	25,59	45	8,2	12	8,5	10,3	28	29,6	.0100	●	●	●
12	1,75	95	29,86	45	9,9	14	10,25	12,3	32,7	34,5	.0112	●	●	●
16	2	110	40,13	48	13,6	18	14	16,3	43,3	45,9	.0116	●	●	●

Andere Abmessungen auf Anfrage
 Other sizes upon request

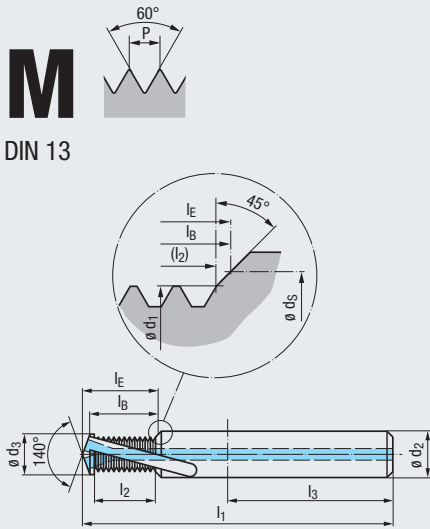

VHM	TICN
R30	RH + LH
Z3	DIN 6535 HB HE HA
90°	ø D

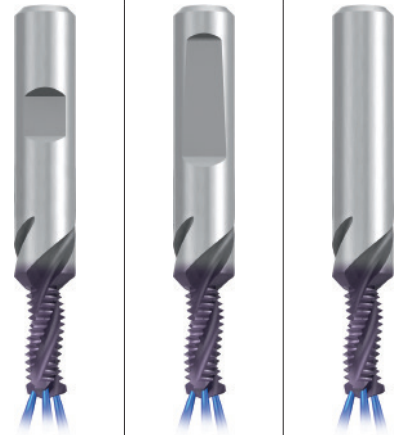

Einsatzgebiete – Material Applications – material **328**

K 1.1-2 N 1.5-6, 2.3

Gewindetiefe Thread depth

1,5 x D

Werkzeug-Ident · Tool ident

ø D mm	P mm	l ₁	l ₂	l ₃	ø d ₁	ø d ₂	ø d ₃	ø d _S	l _B	l _E	Dimens.- Ident	GF422256	GF422556	GF422856
												BGF-VHM-Z3 1,5xD R30-IKZ-HB TICN	BGF-VHM-Z3 1,5xD R30-IKZ-HE TICN	BGF-VHM-Z3 1,5xD R30-IKZ-HA TICN
M 6	1	62	9,06	36	4,8	8	5	6,3	10,7	11,6	.0060	●	●	●
8	1,25	74	11,33	40	6,5	10	6,75	8,3	13,4	14,6	.0080	●	●	●
10	1,5	79	15,09	45	8,2	12	8,5	10,3	17,5	19,1	.0100	●	●	●
12	1,75	89	17,61	45	9,9	14	10,25	12,3	20,4	22,3	.0112	●	●	●
16	2	102	24,13	48	13,6	18	14	16,3	27,3	29,9	.0116	●	●	●

Gewindetiefe Thread depth

2 x D

Werkzeug-Ident · Tool ident

ø D mm	P mm	l ₁	l ₂	l ₃	ø d ₁	ø d ₂	ø d ₃	ø d _S	l _B	l _E	Dimens.- Ident	GF432256	GF432556	GF432856
												BGF-VHM-Z3 2xD R30-IKZ-HB TICN	BGF-VHM-Z3 2xD R30-IKZ-HE TICN	BGF-VHM-Z3 2xD R30-IKZ-HA TICN
M 6	1	62	12,06	36	4,8	8	5	6,3	13,7	14,6	.0060	●	●	●
8	1,25	74	15,08	40	6,5	10	6,75	8,3	17,1	18,3	.0080	●	●	●
10	1,5	79	19,59	45	8,2	12	8,5	10,3	22	23,6	.0100	●	●	●
12	1,75	89	22,86	45	9,9	14	10,25	12,3	25,7	27,5	.0112	●	●	●
16	2	102	32,13	48	13,6	18	14	16,3	35,3	37,9	.0116	●	●	●

Gewindetiefe Thread depth

2,5 x D

Werkzeug-Ident · Tool ident

ø D mm	P mm	l ₁	l ₂	l ₃	ø d ₁	ø d ₂	ø d ₃	ø d _S	l _B	l _E	Dimens.- Ident	GF442256	GF442556	GF442856
												BGF-VHM-Z3 2,5xD R30-IKZ-HB TICN	BGF-VHM-Z3 2,5xD R30-IKZ-HE TICN	BGF-VHM-Z3 2,5xD R30-IKZ-HA TICN
M 6	1	65	15,10	36	4,8	8	5	6,3	16,7	17,6	.0060	●	●	●
8	1,25	80	20,08	40	6,5	10	6,75	8,3	22,1	23,3	.0080	●	●	●
10	1,5	85	25,59	45	8,2	12	8,5	10,3	28	29,6	.0100	●	●	●
12	1,75	95	29,86	45	9,9	14	10,25	12,3	32,7	34,5	.0112	●	●	●
16	2	110	40,13	48	13,6	18	14	16,3	43,3	45,9	.0116	●	●	●

Andere Abmessungen auf Anfrage Other sizes upon request

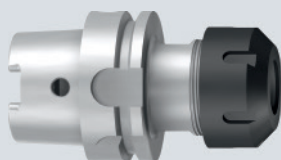

Spannzangen-Aufnahmen
Typ KSN/Synchro
siehe Seite 711 - 713

Collet holders
type KSN/Synchro,
see page 711 - 713

Product Finder

v_c / f_z

M

MF

UNC
UN, UNS

UNF
UNEF

G, Rp

NPT, NPTF
Rc, W

BSW, BSF

Pg

EG (STI)
SELF-LOCK

Tr

Zubehör
Accessories

Tech. Info

BGF

ZBGF

GSF

GF

GF-KEG

ZGF

ZIRK-GF

Gigant

MoSys



- Product Finder
- v_c / f_z
- M
- MF
- UNC UN, UNS
- UNF UNEF
- G, Rp
- NPT, NPTF Rc, W
- BSW, BSF
- Pg
- EG (STI) SELF-LOCK
- Tr
- Zubehör Accessories
- Tech. Info
- BGF
- ZBGF
- GSF
- GF
- GF-KEG
- ZGF
- ZIRK-GF
- Gigant
- MoSys

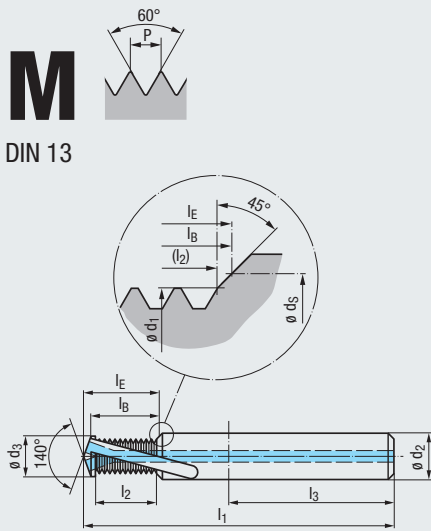

VHM	TICN
R20	RH + LH
Z4	DIN 6535 HB HE HA
90°	$\emptyset D$

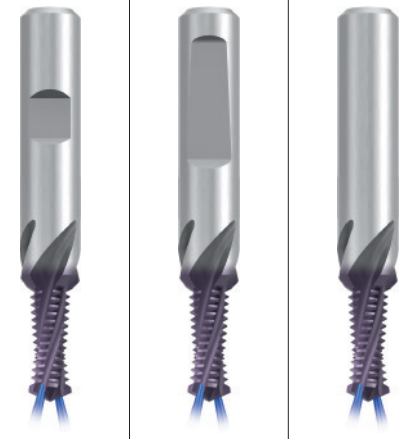

Einsatzgebiete – Material Applications – material » 328

K 1.1-2 **N** 1.5-6, 2.3

Gewindetiefe Thread depth

1,5 x D

Werkzeug-Ident · Tool ident

	GF429246	GF429546	GF429846
BGF-VHM-Z4 1,5xD R20-IKZ-HB TICN	●	●	●
BGF-VHM-Z4 1,5xD R20-IKZ-HE TICN	●	●	●
BGF-VHM-Z4 1,5xD R20-IKZ-HA TICN	●	●	●

$\emptyset D$ mm	P mm	l_1	l_2	l_3	$\emptyset d_1$	$\emptyset d_2$	$\emptyset d_3$	$\emptyset d_S$	l_B	l_E	Dimens.-Ident
M 6	1	62	9,06	36	4,8	8	5	6,3	10,7	11,6	.0060
8	1,25	74	11,33	40	6,5	10	6,75	8,3	13,4	14,6	.0080
10	1,5	79	15,09	45	8,2	12	8,5	10,3	17,5	19,1	.0100
12	1,75	89	17,61	45	9,9	14	10,25	12,3	20,4	22,3	.0112

Gewindetiefe Thread depth

2 x D

Werkzeug-Ident · Tool ident

	GF439246	GF439546	GF439846
BGF-VHM-Z4 2xD R20-IKZ-HB TICN	●	●	●
BGF-VHM-Z4 2xD R20-IKZ-HE TICN	●	●	●
BGF-VHM-Z4 2xD R20-IKZ-HA TICN	●	●	●

$\emptyset D$ mm	P mm	l_1	l_2	l_3	$\emptyset d_1$	$\emptyset d_2$	$\emptyset d_3$	$\emptyset d_S$	l_B	l_E	Dimens.-Ident
M 6	1	62	12,06	36	4,8	8	5	6,3	13,7	14,6	.0060
8	1,25	74	15,08	40	6,5	10	6,75	8,3	17,1	18,3	.0080
10	1,5	79	19,59	45	8,2	12	8,5	10,3	22	23,6	.0100
12	1,75	89	22,86	45	9,9	14	10,25	12,3	25,7	27,5	.0112
16	2	102	32,13	48	13,6	18	14	16,3	35,3	37,9	.0116

Gewindetiefe Thread depth

2,5 x D

Werkzeug-Ident · Tool ident

	GF449246	GF449546	GF449846
BGF-VHM-Z4 2,5xD R20-IKZ-HB TICN	●	●	●
BGF-VHM-Z4 2,5xD R20-IKZ-HE TICN	●	●	●
BGF-VHM-Z4 2,5xD R20-IKZ-HA TICN	●	●	●

$\emptyset D$ mm	P mm	l_1	l_2	l_3	$\emptyset d_1$	$\emptyset d_2$	$\emptyset d_3$	$\emptyset d_S$	l_B	l_E	Dimens.-Ident
M 6	1	65	15,10	36	4,8	8	5	6,3	16,7	17,6	.0060
8	1,25	80	20,08	40	6,5	10	6,75	8,3	22,1	23,3	.0080
10	1,5	85	25,59	45	8,2	12	8,5	10,3	28	29,6	.0100
12	1,75	95	29,86	45	9,9	14	10,25	12,3	32,7	34,5	.0112
16	2	110	40,13	48	13,6	18	14	16,3	43,3	45,9	.0116

Andere Abmessungen auf Anfrage Other sizes upon request

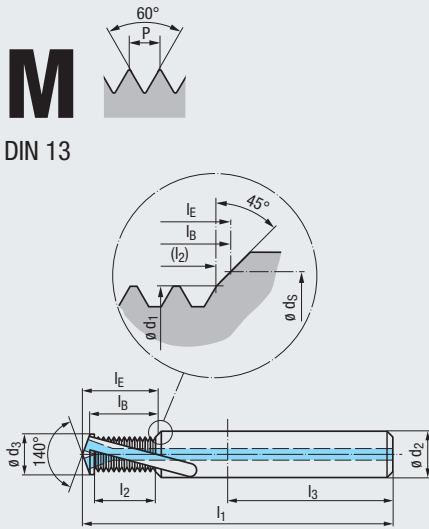

VHM	TIALN T3
R20	RH + LH
Z4	DIN 6535 HB HE HA
90°	Ø D

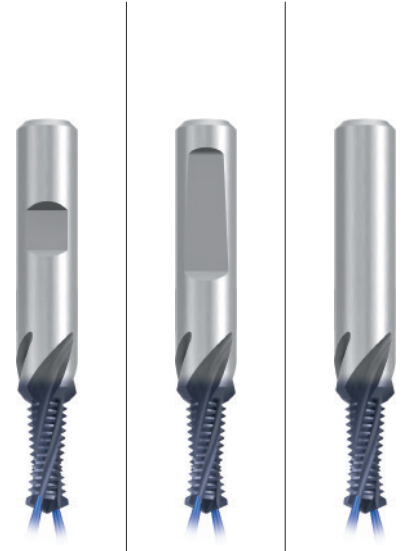

- Product Finder
- v_c / f_z
- M
- MF
- UNC UN, UNS
- UNF UNEF
- G, Rp
- NPT, NPTF Rc, W
- BSW, BSF
- Pg
- EG (STI) SELF-LOCK

Einsatzgebiete – Material Applications – material ▶▶ 328

K 1.1-2 **N** 1.5-6, 2.3

Gewindetiefe Thread depth

1,5 x D

Werkzeug-Ident · Tool ident

Ø D mm	P mm	l ₁	l ₂	l ₃	Ø d ₁	Ø d ₂	Ø d ₃	Ø d _S	l _B	l _E	Dimens.-Ident	GF429248	GF429548	GF429848
												BGF-VHM-Z4 1,5xD R20-1KZ-HB TIALN-T3	BGF-VHM-Z4 1,5xD R20-1KZ-HE TIALN-T3	BGF-VHM-Z4 1,5xD R20-1KZ-HA TIALN-T3
M 6	1	62	9,06	36	4,8	8	5	6,3	10,7	11,6	.0060	●	●	●
8	1,25	74	11,33	40	6,5	10	6,75	8,3	13,4	14,6	.0080	●	●	●
10	1,5	79	15,09	45	8,2	12	8,5	10,3	17,5	19,1	.0100	●	●	●
12	1,75	89	17,61	45	9,9	14	10,25	12,3	20,4	22,3	.0112	●	●	●

Gewindetiefe Thread depth

2 x D

Werkzeug-Ident · Tool ident

Ø D mm	P mm	l ₁	l ₂	l ₃	Ø d ₁	Ø d ₂	Ø d ₃	Ø d _S	l _B	l _E	Dimens.-Ident	GF439248	GF439548	GF439848
												BGF-VHM-Z4 2xD R20-1KZ-HB TIALN-T3	BGF-VHM-Z4 2xD R20-1KZ-HE TIALN-T3	BGF-VHM-Z4 2xD R20-1KZ-HA TIALN-T3
M 6	1	62	12,06	36	4,8	8	5	6,3	13,7	14,6	.0060	●	●	●
8	1,25	74	15,08	40	6,5	10	6,75	8,3	17,1	18,3	.0080	●	●	●
10	1,5	79	19,59	45	8,2	12	8,5	10,3	22	23,6	.0100	●	●	●
12	1,75	89	22,86	45	9,9	14	10,25	12,3	25,7	27,5	.0112	●	●	●
16	2	102	32,13	48	13,6	18	14	16,3	35,3	37,9	.0116	●	●	●

Gewindetiefe Thread depth

2,5 x D

Werkzeug-Ident · Tool ident

Ø D mm	P mm	l ₁	l ₂	l ₃	Ø d ₁	Ø d ₂	Ø d ₃	Ø d _S	l _B	l _E	Dimens.-Ident	GF449248	GF449548	GF449848
												BGF-VHM-Z4 2,5xD R20-1KZ-HB TIALN-T3	BGF-VHM-Z4 2,5xD R20-1KZ-HE TIALN-T3	BGF-VHM-Z4 2,5xD R20-1KZ-HA TIALN-T3
M 6	1	65	15,10	36	4,8	8	5	6,3	16,7	17,6	.0060	●	●	●
8	1,25	80	20,08	40	6,5	10	6,75	8,3	22,1	23,3	.0080	●	●	●
10	1,5	85	25,59	45	8,2	12	8,5	10,3	28	29,6	.0100	●	●	●
12	1,75	95	29,86	45	9,9	14	10,25	12,3	32,7	34,5	.0112	●	●	●
16	2	110	40,13	48	13,6	18	14	16,3	43,3	45,9	.0116	●	●	●

Andere Abmessungen auf Anfrage Other sizes upon request

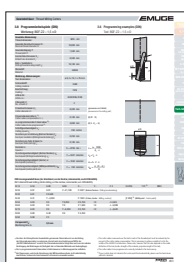

Programmierbeispiel für Bohrwinddefräser Typ BGF siehe Seite 463

Programming example for drill thread mills type BGF, see page 463

- Product Finder
- v_c / f_z
- M
- MF**
- UNC
UN, UNS
- UNF
UNEF
- G, Rp
- NPT, NPTF
Rc, W
- BSW, BSF
- Pg
- EG (STI)
SELF-LOCK
- Tr
- Zubehör
Accessories
- Tech. Info
- BGF
- ZBGF
- GSF
- GF
- GF-KEG
- ZGF
- ZIRK-GF
- Gigant
- MoSys

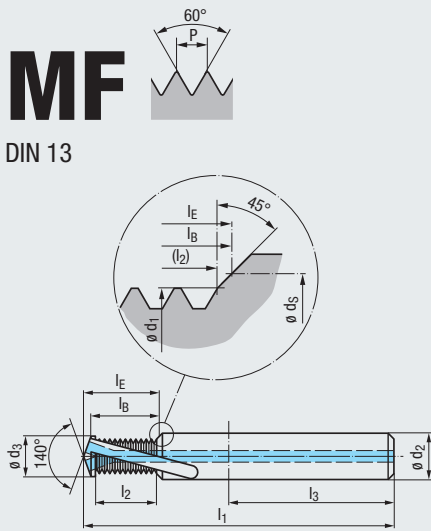

VHM

R30 **RH + LH**

Z2 **DIN 6535**
HB
HE
HA

90° **Ø D**

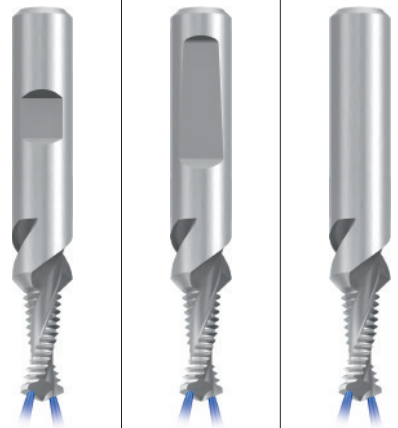

Einsatzgebiete – Material » 328
Applications – material

K 1.1-3.2 **N** 1.1-5
N 2.2-3, 2.6 **N** 3.1-2, 4.1

Gewindetiefe
Thread depth

1,5 x D

Werkzeug-Ident · Tool ident

											GF422201	GF422501	GF422801	
											BGF-VHM-Z2 1,5xD R30-IKZ-HB	BGF-VHM-Z2 1,5xD R30-IKZ-HE	BGF-VHM-Z2 1,5xD R30-IKZ-HA	
Ø D mm	P mm	l ₁	l ₂	l ₃	Ø d ₁	Ø d ₂	Ø d ₃	Ø d _S	l _B	l _E	Dimens.- Ident			
M 4 x 0,5	49	5,05	36	3,36	6	3,5	4,3	7	7,6	.0210				
5 x 0,5	55	7,56	36	4,34	6	4,5	5,3	8,5	9,3	.0218				
6 x 0,75	62	9,07	36	5,05	8	5,25	6,3	10,4	11,3	.0229	●	●	●	
8 x 1	74	12,09	40	6,75	10	7	8,3	13,8	15	.0251	●	●	●	
10 x 1	79	15,11	45	8,7	12	9	10,3	16,8	18,4	.0276	●	●	●	
10 x 1,25	79	15,11	45	8,4	12	8,75	10,3	17,2	18,8	.0277	●	●	●	
12 x 1	89	17,14	45	10,65	14	11	12,3	18,8	20,8	.0301				
12 x 1,25	89	18,88	45	10,4	14	10,75	12,3	20,9	22,9	.0302	●	●	●	
12 x 1,5	89	18,12	45	10,15	14	10,5	12,3	20,5	22,5	.0303	●	●	●	
14 x 1,5	102	21,14	48	12,1	16	12,5	14,3	23,6	25,8	.0331	●	●	●	
16 x 1,5	102	24,15	48	14,1	18	14,5	16,3	26,6	29,2	.0359	●	●	●	

Gewindetiefe
Thread depth

2 x D

Werkzeug-Ident · Tool ident

											GF432201	GF432501	GF432801	
											BGF-VHM-Z2 2xD R30-IKZ-HB	BGF-VHM-Z2 2xD R30-IKZ-HE	BGF-VHM-Z2 2xD R30-IKZ-HA	
Ø D mm	P mm	l ₁	l ₂	l ₃	Ø d ₁	Ø d ₂	Ø d ₃	Ø d _S	l _B	l _E	Dimens.- Ident			
M 4 x 0,5	49	8,05	36	3,36	6	3,5	4,3	9	9,6	.0210				
5 x 0,5	55	10,06	36	4,34	6	4,5	5,3	11	11,8	.0218				
6 x 0,75	62	12,07	36	5,05	8	5,25	6,3	13,4	14,3	.0229	●	●	●	
8 x 1	74	16,09	40	6,75	10	7	8,3	17,8	19	.0251	●	●	●	
10 x 1	79	20,11	45	8,7	12	9	10,3	21,8	23,4	.0276	●	●	●	
10 x 1,25	79	20,11	45	8,4	12	8,75	10,3	22,2	23,8	.0277	●	●	●	
12 x 1	89	24,14	45	10,65	14	11	12,3	25,8	27,8	.0301				
12 x 1,25	89	23,88	45	10,4	14	10,75	12,3	25,9	27,9	.0302	●	●	●	
12 x 1,5	89	24,12	45	10,15	14	10,5	12,3	26,5	28,5	.0303	●	●	●	
14 x 1,5	102	27,14	48	12,1	16	12,5	14,3	29,6	31,8	.0331	●	●	●	
16 x 1,5	102	31,65	48	14,1	18	14,5	16,3	34,1	36,7	.0359	●	●	●	

Andere Abmessungen auf Anfrage
Other sizes upon request

MF

DIN 13

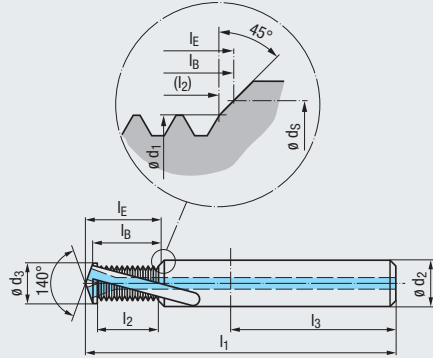

VHM	TICN
R30	RH + LH
Z2	DIN 6535 HB HE HA
90°	ø D

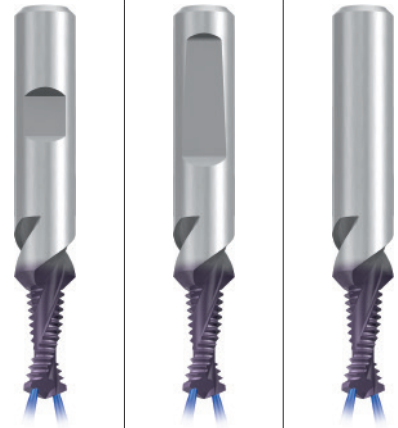

Einsatzgebiete – Material Applications – material » 328

K 1.1-3.2 **N** 1.1-6
N 2.2-3, 2.6 **N** 3.1-2, 4.1

Gewindetiefe Thread depth

1,5 x D

Werkzeug-Ident · Tool ident

												GF422206	GF422506	GF422806
												BGF-VHM-Z2 1,5xD R30-1KZ-HB TICN	BGF-VHM-Z2 1,5xD R30-1KZ-HE TICN	BGF-VHM-Z2 1,5xD R30-1KZ-HA TICN
ø D mm	P mm	l ₁	l ₂	l ₃	ø d ₁	ø d ₂	ø d ₃	ø d _S	l _B	l _E	Dimens.- Ident			
M 4 x 0,5	49	5,05	36	3,36	6	3,5	4,3	7	7,6	.0210				
5 x 0,5	55	7,56	36	4,34	6	4,5	5,3	8,5	9,3	.0218				
6 x 0,75	62	9,07	36	5,05	8	5,25	6,3	10,4	11,3	.0229	●	●	●	
8 x 1	74	12,09	40	6,75	10	7	8,3	13,8	15	.0251	●	●	●	
10 x 1	79	15,11	45	8,7	12	9	10,3	16,8	18,4	.0276	●	●	●	
10 x 1,25	79	15,11	45	8,4	12	8,75	10,3	17,2	18,8	.0277	●	●	●	
12 x 1	89	17,14	45	10,65	14	11	12,3	18,8	20,8	.0301	●	●	●	
12 x 1,25	89	18,88	45	10,4	14	10,75	12,3	20,9	22,9	.0302	●	●	●	
12 x 1,5	89	18,12	45	10,15	14	10,5	12,3	20,5	22,5	.0303	●	●	●	
14 x 1,5	102	21,14	48	12,1	16	12,5	14,3	23,6	25,8	.0331	●	●	●	
16 x 1,5	102	24,15	48	14,1	18	14,5	16,3	26,6	29,2	.0359	●	●	●	

Gewindetiefe Thread depth

2 x D

Werkzeug-Ident · Tool ident

												GF432206	GF432506	GF432806
												BGF-VHM-Z2 2xD R30-1KZ-HB TICN	BGF-VHM-Z2 2xD R30-1KZ-HE TICN	BGF-VHM-Z2 2xD R30-1KZ-HA TICN
ø D mm	P mm	l ₁	l ₂	l ₃	ø d ₁	ø d ₂	ø d ₃	ø d _S	l _B	l _E	Dimens.- Ident			
M 4 x 0,5	49	8,05	36	3,36	6	3,5	4,3	9	9,6	.0210				
5 x 0,5	55	10,06	36	4,34	6	4,5	5,3	11	11,8	.0218				
6 x 0,75	62	12,07	36	5,05	8	5,25	6,3	13,4	14,3	.0229	●	●	●	
8 x 1	74	16,09	40	6,75	10	7	8,3	17,8	19	.0251	●	●	●	
10 x 1	79	20,11	45	8,7	12	9	10,3	21,8	23,4	.0276	●	●	●	
10 x 1,25	79	20,11	45	8,4	12	8,75	10,3	22,2	23,8	.0277	●	●	●	
12 x 1	89	24,14	45	10,65	14	11	12,3	25,8	27,8	.0301	●	●	●	
12 x 1,25	89	23,88	45	10,4	14	10,75	12,3	25,9	27,9	.0302	●	●	●	
12 x 1,5	89	24,12	45	10,15	14	10,5	12,3	26,5	28,5	.0303	●	●	●	
14 x 1,5	102	27,14	48	12,1	16	12,5	14,3	29,6	31,8	.0331	●	●	●	
16 x 1,5	102	31,65	48	14,1	18	14,5	16,3	34,1	36,7	.0359	●	●	●	

Andere Abmessungen auf Anfrage
Other sizes upon request

Product Finder

v_c / f_z

M

MF

UNC
UN, UNS

UNF
UNEF

G, Rp

NPT, NPTF
Rc, W

BSW, BSF

Pg

EG (STI)
SELF-LOCK

Tr

Zubehör
Accessories

Tech. Info

BGF

ZBGF

GSF

GF

GF-KEG

ZGF

ZIRK-GF

Gigant

MoSys

- Product Finder
- v_c / f_z
- M
- MF**
- UNC
UN, UNS
- UNF
UNEF
- G, Rp
- NPT, NPTF
Rc, W
- BSW, BSF
- Pg
- EG (STI)
SELF-LOCK
- Tr
- Zubehör
Accessories
- Tech. Info
- BGF**
- ZBGF
- GSF
- GF
- GF-KEG
- ZGF
- ZIRK-GF
- Gigant
- MoSys

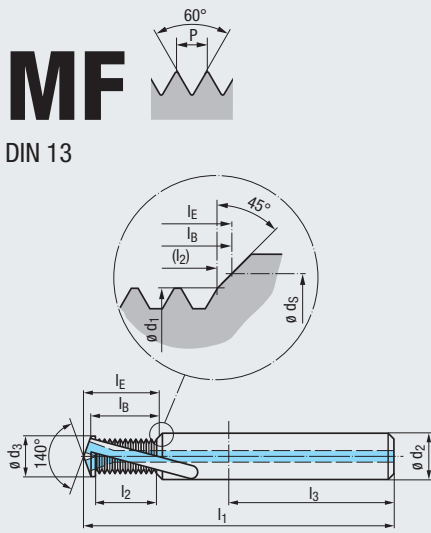

VHM	TICN
R20	RH + LH
Z4	DIN 6535 HB HE HA
90°	$\varnothing D$

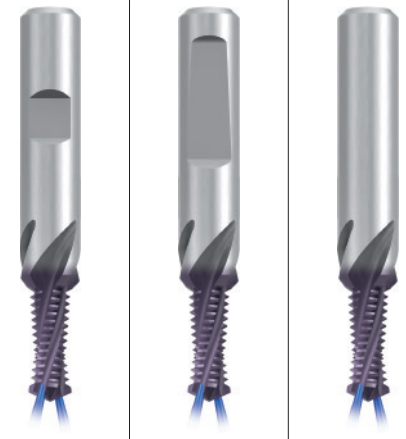

Einsatzgebiete – Material Applications – material » 328

K 1.1-2 **N** 1.5-6, 2,3

Gewindetiefe Thread depth

2 x D

Werkzeug-Ident · Tool ident

	GF439246	GF439546	GF439846
BGF-VHM-Z4 2xD R20-IKZ-HB TICN	●	●	●
BGF-VHM-Z4 2xD R20-IKZ-HE TICN	●	●	●
BGF-VHM-Z4 2xD R20-IKZ-HA TICN	●	●	●

	$\varnothing D$ mm	P mm	Dimens.-Ident									
			l_1	l_2	l_3	$\varnothing d_1$	$\varnothing d_2$	$\varnothing d_3$	$\varnothing d_S$	l_B	l_E	
M	8	x 1	74	16,09	40	6,75	10	7	8,3	17,8	19	.0251
	10	x 1	79	20,11	45	8,7	12	9	10,3	21,8	23,4	.0276
	12	x 1,5	89	24,12	45	10,15	14	10,5	12,3	26,5	28,5	.0303
	16	x 1,5	102	31,65	48	14,1	18	14,5	16,3	34,1	36,7	.0359

Andere Abmessungen auf Anfrage
Other sizes upon request

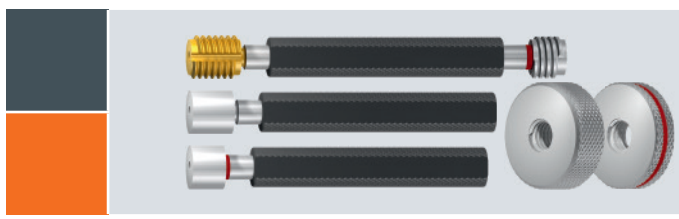

Gewindelehren
siehe Seite 581 - 654

Thread gauges,
see page 581 - 654

MF

DIN 13

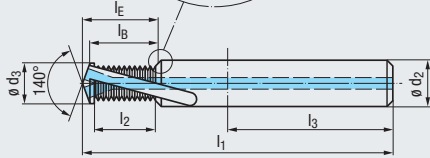
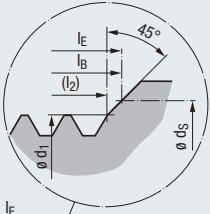

VHM	TIALN T3
R20	RH + LH
Z4	DIN 6535 HB HE HA
90°	Ø D

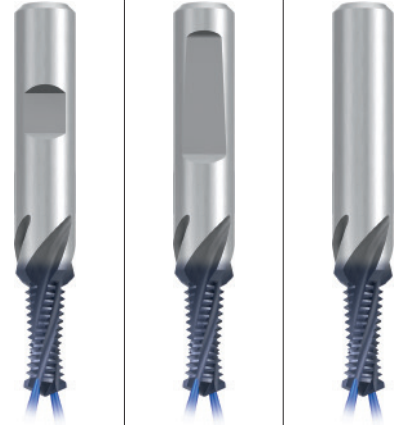

Einsatzgebiete – Material Applications – material **328**

K 1.1-2 N 1.5-6, 2.3

Gewindetiefe Thread depth

2 x D

Werkzeug-Ident · Tool ident

GF439248 GF439548 GF439848

Ø D mm	P mm	l ₁	l ₂	l ₃	Ø d ₁	Ø d ₂	Ø d ₃	Ø d _S	l _B	l _E	Dimens.- Ident	BGF439248	BGF439548	BGF439848
												BGF-VHM-Z4 2xD R20-1KZ-HB TIALN-T3	BGF-VHM-Z4 2xD R20-1KZ-HE TIALN-T3	BGF-VHM-Z4 2xD R20-1KZ-HA TIALN-T3
M 8	x 1	74	16,09	40	6,75	10	7	8,3	17,8	19	.0251	●	●	●
10	x 1	79	20,11	45	8,7	12	9	10,3	21,8	23,4	.0276	●	●	●
12	x 1,5	89	24,12	45	10,15	14	10,5	12,3	26,5	28,5	.0303	●	●	●
16	x 1,5	102	31,65	48	14,1	18	14,5	16,3	34,1	36,7	.0359	●	●	●

Andere Abmessungen auf Anfrage
Other sizes upon request

Product Finder

v_c / f_z

M

MF

UNC
UN, UNS

UNF
UNEF

G, Rp

NPT, NPTF
Rc, W

BSW, BSF

Pg

EG (STI)
SELF-LOCK

Tr

Zubehör
Accessories

Tech. Info

BGF

ZBGF

GSF

GF

GF-KEG

ZGF

ZIRK-GF

Gigant

MoSys



- Product Finder
- v_c / f_z
- M
- MF
- UNC**
UN, UNS
- UNF
UNEF
- G, Rp
- NPT, NPTF
Rc, W
- BSW, BSF
- Pg
- EG (STI)
SELF-LOCK
- Tr
- Zubehör
Accessories
- Tech. Info
- BGF**
- ZBGF
- GSF
- GF
- GF-KEG
- ZGF
- ZIRK-GF
- Gigant
- MoSys

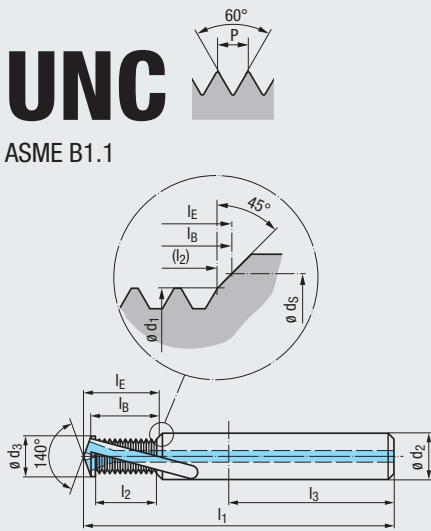

VHM

R30 **RH + LH**

Z2 **DIN 6535**
HB
HE
HA

90° **Ø D**

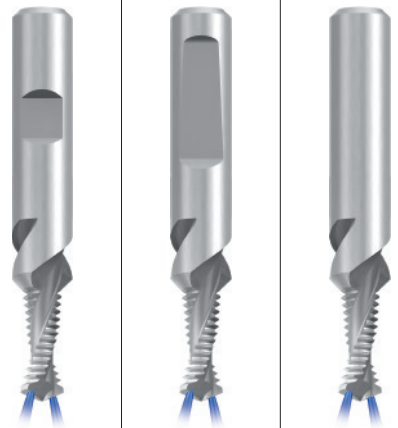

Einsatzgebiete – Material Applications – material **328**

K 1.1-3.2 **N 1.1-5**
N 2.2-3, 2.6 **N 3.1-2, 4.1**

Gewindetiefe Thread depth

1,5 x D

Werkzeug-Ident · Tool ident												GF422201	GF422501	GF422801
												BGF-VHM-Z2 1,5xD R30-IKZ-HB	BGF-VHM-Z2 1,5xD R30-IKZ-HE	BGF-VHM-Z2 1,5xD R30-IKZ-HA
Ø D inch	P Gg/1" (tpi)	l_1	l_2	l_3	$\varnothing d_1$	$\varnothing d_2$	$\varnothing d_3$	$\varnothing d_S$	l_B	l_E	Dimens.- Ident			
Nr. 12	24	62	7,50	36	4,21	8	4,5	5,79	9,2	10	.5008			
1/4	20	62	8,99	36	4,85	8	5,2	6,65	11,1	12	.5009	●	●	●
5/16	18	74	11,39	40	6,25	10	6,6	8,25	13,7	14,9	.5010	●	●	●
3/8	16	79	14,40	45	7,65	12	8	9,83	16,9	18,4	.5011	●	●	●
7/16	14	79	16,45	45	9	12	9,4	11,43	19,3	21	.5012	●	●	●
1/2	13	89	17,71	45	10,35	14	10,75	13	20,8	22,8	.5013	●	●	●
9/16	12	102	21,31	48	11,8	16	12,25	14,61	24,7	26,9	.5014	●	●	●
5/8	11	102	23,21	48	13,1	18	13,5	16,18	26,9	29,3	.5015	●	●	●
3/4	10	115	28,10	50	16	20	16,5	19,35	32,1	35,1	.5016			

Gewindetiefe Thread depth

2 x D

Werkzeug-Ident · Tool ident												GF432201	GF432501	GF432801
												BGF-VHM-Z2 2xD R30-IKZ-HB	BGF-VHM-Z2 2xD R30-IKZ-HE	BGF-VHM-Z2 2xD R30-IKZ-HA
Ø D inch	P Gg/1" (tpi)	l_1	l_2	l_3	$\varnothing d_1$	$\varnothing d_2$	$\varnothing d_3$	$\varnothing d_S$	l_B	l_E	Dimens.- Ident			
Nr. 12	24	62	10,66	36	4,21	8	4,5	5,79	12,4	13,2	.5008			
1/4	20	62	12,80	36	4,85	8	5,2	6,65	14,9	15,8	.5009	●	●	●
5/16	18	74	15,63	40	6,25	10	6,6	8,25	17,9	19,1	.5010	●	●	●
3/8	16	79	19,16	45	7,65	12	8	9,83	21,7	23,2	.5011	●	●	●
7/16	14	79	21,89	45	9	12	9,4	11,43	24,8	26,5	.5012	●	●	●
1/2	13	89	25,52	45	10,35	14	10,75	13	28,6	30,6	.5013	●	●	●
9/16	12	102	27,66	48	11,8	16	12,25	14,61	31	33,2	.5014	●	●	●
5/8	11	102	30,14	48	13,1	18	13,5	16,18	33,8	36,2	.5015	●	●	●
3/4	10	115	38,26	50	16	20	16,5	19,35	42,2	45,2	.5016			

Gewindetiefe Thread depth

2,5 x D

Werkzeug-Ident · Tool ident												GF442201	GF442501	GF442801
												BGF-VHM-Z2 2,5xD R30-IKZ-HB	BGF-VHM-Z2 2,5xD R30-IKZ-HE	BGF-VHM-Z2 2,5xD R30-IKZ-HA
Ø D inch	P Gg/1" (tpi)	l_1	l_2	l_3	$\varnothing d_1$	$\varnothing d_2$	$\varnothing d_3$	$\varnothing d_S$	l_B	l_E	Dimens.- Ident			
3/8	16	85	23,93	45	7,65	12	8	9,83	26,5	27,9	.5011	●	●	●
7/16	14	85	27,33	45	9	12	9,4	11,43	30,2	31,9	.5012	●	●	●
1/2	13	95	31,39	45	10,35	14	10,75	13	34,5	36,5	.5013	●	●	●
9/16	12	110	34,01	48	11,8	16	12,25	14,61	37,3	39,6	.5014	●	●	●
5/8	11	110	39,38	48	13,1	18	13,5	16,18	43	45,5	.5015			
3/4	10	125	45,88	50	16	20	16,5	19,35	49,9	52,9	.5016			

Andere Abmessungen auf Anfrage
Other sizes upon request

UNC

ASME B1.1

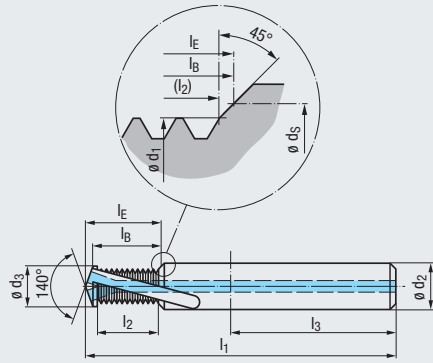

VHM	TICN
R30	RH + LH
Z2	DIN 6535 HB HE HA
90°	Ø D

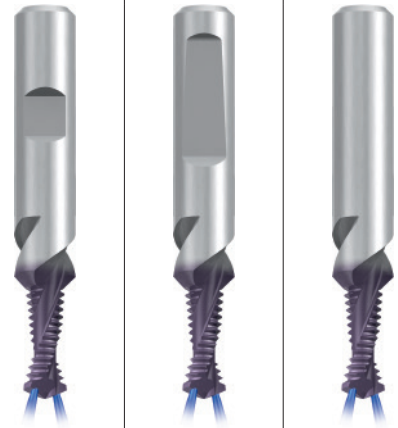

Einsatzgebiete – Material Applications – material » 328

K 1.1-3.2 **N** 1.1-6
N 2.2-3, 2.6 **N** 3.1-2, 4.1

Gewindetiefe Thread depth

1,5 x D

Werkzeug-Ident · Tool ident

												GF422206	GF422506	GF422806
												BGF-VHM-Z2 1,5xD R30-IKZ-HB TICN	BGF-VHM-Z2 1,5xD R30-IKZ-HE TICN	BGF-VHM-Z2 1,5xD R30-IKZ-HA TICN
Ø D inch	P Gg/1" (tpi)	l ₁	l ₂	l ₃	Ø d ₁	Ø d ₂	Ø d ₃	Ø d _S	l _B	l _E	Dimens.-Ident			
Nr. 12	24	62	7,50	36	4,21	8	4,5	5,79	9,2	10	.5008			
1/4	20	62	8,99	36	4,85	8	5,2	6,65	11,1	12	.5009	●	●	●
5/16	18	74	11,39	40	6,25	10	6,6	8,25	13,7	14,9	.5010	●	●	●
3/8	16	79	14,40	45	7,65	12	8	9,83	16,9	18,4	.5011	●	●	●
7/16	14	79	16,45	45	9	12	9,4	11,43	19,3	21	.5012	●	●	●
1/2	13	89	17,71	45	10,35	14	10,75	13	20,8	22,8	.5013	●	●	●
9/16	12	102	21,31	48	11,8	16	12,25	14,61	24,7	26,9	.5014	●	●	●
5/8	11	102	23,21	48	13,1	18	13,5	16,18	26,9	29,3	.5015	●	●	●
3/4	10	115	28,10	50	16	20	16,5	19,35	32,1	35,1	.5016	●	●	●

Gewindetiefe Thread depth

2 x D

Werkzeug-Ident · Tool ident

												GF432206	GF432506	GF432806
												BGF-VHM-Z2 2xD R30-IKZ-HB TICN	BGF-VHM-Z2 2xD R30-IKZ-HE TICN	BGF-VHM-Z2 2xD R30-IKZ-HA TICN
Ø D inch	P Gg/1" (tpi)	l ₁	l ₂	l ₃	Ø d ₁	Ø d ₂	Ø d ₃	Ø d _S	l _B	l _E	Dimens.-Ident			
Nr. 12	24	62	10,66	36	4,21	8	4,5	5,79	12,4	13,2	.5008			
1/4	20	62	12,80	36	4,85	8	5,2	6,65	14,9	15,8	.5009	●	●	●
5/16	18	74	15,63	40	6,25	10	6,6	8,25	17,9	19,1	.5010	●	●	●
3/8	16	79	19,16	45	7,65	12	8	9,83	21,7	23,2	.5011	●	●	●
7/16	14	79	21,89	45	9	12	9,4	11,43	24,8	26,5	.5012	●	●	●
1/2	13	89	25,52	45	10,35	14	10,75	13	28,6	30,6	.5013	●	●	●
9/16	12	102	27,66	48	11,8	16	12,25	14,61	31	33,2	.5014	●	●	●
5/8	11	102	30,14	48	13,1	18	13,5	16,18	33,8	36,2	.5015	●	●	●
3/4	10	115	38,26	50	16	20	16,5	19,35	42,2	45,2	.5016	●	●	●

Gewindetiefe Thread depth

2,5 x D

Werkzeug-Ident · Tool ident

												GF442206	GF442506	GF442806
												BGF-VHM-Z2 2,5xD R30-IKZ-HB TICN	BGF-VHM-Z2 2,5xD R30-IKZ-HE TICN	BGF-VHM-Z2 2,5xD R30-IKZ-HA TICN
Ø D inch	P Gg/1" (tpi)	l ₁	l ₂	l ₃	Ø d ₁	Ø d ₂	Ø d ₃	Ø d _S	l _B	l _E	Dimens.-Ident			
3/8	16	85	23,93	45	7,65	12	8	9,83	26,5	27,9	.5011	●	●	●
7/16	14	85	27,33	45	9	12	9,4	11,43	30,2	31,9	.5012	●	●	●
1/2	13	95	31,39	45	10,35	14	10,75	13	34,5	36,5	.5013	●	●	●
9/16	12	110	34,01	48	11,8	16	12,25	14,61	37,3	39,6	.5014	●	●	●
5/8	11	110	39,38	48	13,1	18	13,5	16,18	43	45,5	.5015	●	●	●
3/4	10	125	45,88	50	16	20	16,5	19,35	49,9	52,9	.5016	●	●	●

Andere Abmessungen auf Anfrage
Other sizes upon request

Product Finder

v_c / f_z

M

MF

UNC

UN, UNS

UNF

UNEF

G, Rp

NPT, NPTF

Rc, W

BSW, BSF

Pg

EG (STI)

SELF-LOCK

Tr

Zubehör

Accessories

Tech. Info

BGF

ZBGF

GSF

GF

GF-KEG

ZGF

ZIRK-GF

Gigant

MoSys

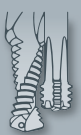

- Product Finder
- v_c / f_z
- M
- MF
- UNC
UN, UNS
- UNF**
UNEF
- G, Rp
- NPT, NPTF
Rc, W
- BSW, BSF
- Pg
- EG (STI)
SELF-LOCK
- Tr
- Zubehör
Accessories
- Tech. Info
- BGF
- ZBGF
- GSF
- GF
- GF-KEG
- ZGF
- ZIRK-GF
- Gigant
- MoSys

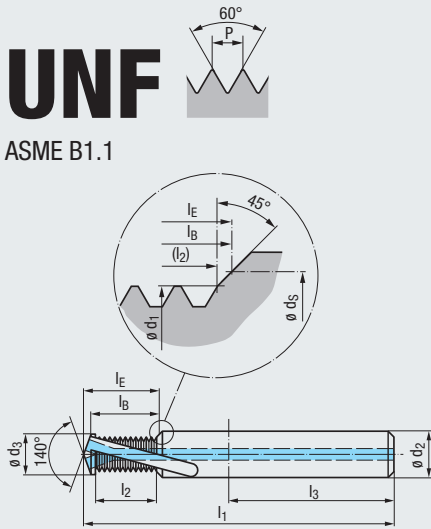

VHM

R30 **RH + LH**

Z2 **DIN 6535**
 HB
 HE
 HA

90° **Ø D**

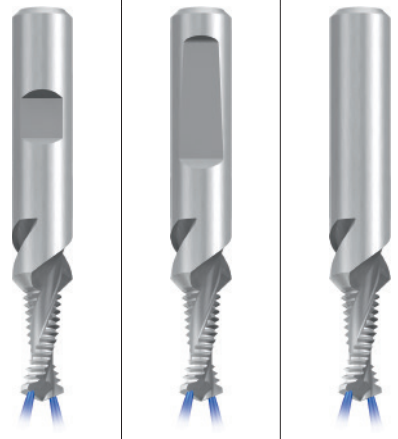

Einsatzgebiete – Material Applications – material **328**

K 1.1-3.2 **N 1.1-5**
N 2.2-3, 2.6 **N 3.1-2, 4.1**

Gewindetiefe Thread depth

1,5 x D

Werkzeug-Ident · Tool ident												GF422201	GF422501	GF422801
											Dimens.-Ident	BGF-VHM-Z2 1,5xD R30-IKZ-HB	BGF-VHM-Z2 1,5xD R30-IKZ-HE	BGF-VHM-Z2 1,5xD R30-IKZ-HA
Ø D inch	P Gg/1" (tpi)	l_1	l_2	l_3	$\varnothing d_1$	$\varnothing d_2$	$\varnothing d_3$	$\varnothing d_S$	l_B	l_E				
Nr. 10	32	55	7,24	36	3,8	6	4,1	5,15	8,6	9,3	.5041			
Nr. 12	28	62	8,27	36	4,36	8	4,65	5,8	9,8	10,6	.5042			
1/4	28	62	9,16	36	5,26	8	5,5	6,65	10,6	11,6	.5043	●	●	●
5/16	24	74	11,74	40	6,6	10	6,9	8,25	13,5	14,7	.5044	●	●	●
3/8	24	79	13,87	45	8,2	12	8,5	9,85	15,6	17,2	.5045	●	●	●
7/16	20	79	17,91	45	9,55	12	9,9	11,4	19,9	21,7	.5046	●	●	●
1/2	20	89	19,20	45	11,1	14	11,5	13	21,2	23,3	.5047	●	●	●
9/16	18	102	21,32	48	12,5	16	12,9	14,6	23,6	25,9	.5048	●	●	●
5/8	18	102	22,74	48	14,1	18	14,5	16,2	25	27,6	.5049	●	●	●
3/4	16	115	28,78	50	17	20	17,5	19,4	31,3	34,5	.5050			

Gewindetiefe Thread depth

2 x D

Werkzeug-Ident · Tool ident												GF432201	GF432501	GF432801
											Dimens.-Ident	BGF-VHM-Z2 2xD R30-IKZ-HB	BGF-VHM-Z2 2xD R30-IKZ-HE	BGF-VHM-Z2 2xD R30-IKZ-HA
Ø D inch	P Gg/1" (tpi)	l_1	l_2	l_3	$\varnothing d_1$	$\varnothing d_2$	$\varnothing d_3$	$\varnothing d_S$	l_B	l_E				
Nr. 10	32	55	9,63	36	3,8	6	4,1	5,15	11	11,7	.5041			
Nr. 12	28	62	10,99	36	4,36	8	4,65	5,8	12,5	13,3	.5042			
1/4	28	62	12,79	36	5,26	8	5,5	6,65	14,3	15,3	.5043	●	●	●
5/16	24	74	15,98	40	6,6	10	6,9	8,25	17,7	19	.5044	●	●	●
3/8	24	79	19,16	45	8,2	12	8,5	9,85	20,9	22,4	.5045	●	●	●
7/16	20	79	21,72	45	9,55	12	9,9	11,4	23,8	25,5	.5046	●	●	●
1/2	20	89	25,55	45	11,1	14	11,5	13	27,6	29,7	.5047	●	●	●
9/16	18	102	28,37	48	12,5	16	12,9	14,6	30,6	33	.5048	●	●	●
5/8	18	102	31,21	48	14,1	18	14,5	16,2	33,5	36,1	.5049	●	●	●
3/4	16	115	38,31	50	17	20	17,5	19,4	40,9	44,1	.5050			

Andere Abmessungen auf Anfrage
 Other sizes upon request

UNF

ASME B1.1

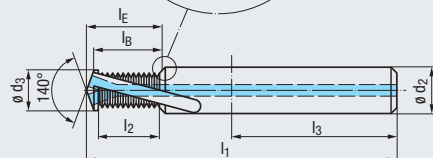
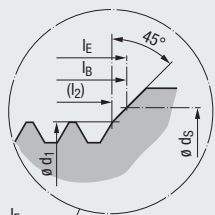
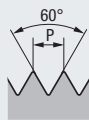

VHM

TICN

R30

RH + LH

Z2



DIN 6535

HB

HE

HA

90°



ø D

Einsatzgebiete – Material
Applications – material

328

K	1.1-3.2	N	1.1-6
N	2.2-3, 2.6	N	3.1-2, 4.1

Gewindetiefe
Thread depth**1,5 x D**

Werkzeug-Ident · Tool ident

GF422206

GF422506

GF422806

ø D inch	P Gg/1" (tpi)	l ₁	l ₂	l ₃	ø d ₁	ø d ₂	ø d ₃	ø d _S	l _B	l _E	Dimens.- Ident	BGF-VHM-Z2 1,5xD R30- IKZ -HB TICN	BGF-VHM-Z2 1,5xD R30- IKZ -HE TICN	BGF-VHM-Z2 1,5xD R30- IKZ -HA TICN
Nr. 10	32	55	7,24	36	3,8	6	4,1	5,15	8,6	9,3	.5041			
Nr. 12	28	62	8,27	36	4,36	8	4,65	5,8	9,8	10,6	.5042			
1/4	28	62	9,16	36	5,26	8	5,5	6,65	10,6	11,6	.5043	●	●	●
5/16	24	74	11,74	40	6,6	10	6,9	8,25	13,5	14,7	.5044	●	●	●
3/8	24	79	13,87	45	8,2	12	8,5	9,85	15,6	17,2	.5045	●	●	●
7/16	20	79	17,91	45	9,55	12	9,9	11,4	19,9	21,7	.5046	●	●	●
1/2	20	89	19,20	45	11,1	14	11,5	13	21,2	23,3	.5047	●	●	●
9/16	18	102	21,32	48	12,5	16	12,9	14,6	23,6	25,9	.5048	●	●	●
5/8	18	102	22,74	48	14,1	18	14,5	16,2	25	27,6	.5049	●	●	●
3/4	16	115	28,78	50	17	20	17,5	19,4	31,3	34,5	.5050			

Gewindetiefe
Thread depth**2 x D**

Werkzeug-Ident · Tool ident

GF432206

GF432506

GF432806

ø D inch	P Gg/1" (tpi)	l ₁	l ₂	l ₃	ø d ₁	ø d ₂	ø d ₃	ø d _S	l _B	l _E	Dimens.- Ident	BGF-VHM-Z2 2xD R30- IKZ -HB TICN	BGF-VHM-Z2 2xD R30- IKZ -HE TICN	BGF-VHM-Z2 2xD R30- IKZ -HA TICN
Nr. 10	32	55	9,63	36	3,8	6	4,1	5,15	11	11,7	.5041			
Nr. 12	28	62	10,99	36	4,36	8	4,65	5,8	12,5	13,3	.5042			
1/4	28	62	12,79	36	5,26	8	5,5	6,65	14,3	15,3	.5043	●	●	●
5/16	24	74	15,98	40	6,6	10	6,9	8,25	17,7	19	.5044	●	●	●
3/8	24	79	19,16	45	8,2	12	8,5	9,85	20,9	22,4	.5045	●	●	●
7/16	20	79	21,72	45	9,55	12	9,9	11,4	23,8	25,5	.5046	●	●	●
1/2	20	89	25,55	45	11,1	14	11,5	13	27,6	29,7	.5047	●	●	●
9/16	18	102	28,37	48	12,5	16	12,9	14,6	30,6	33	.5048	●	●	●
5/8	18	102	31,21	48	14,1	18	14,5	16,2	33,5	36,1	.5049	●	●	●
3/4	16	115	38,31	50	17	20	17,5	19,4	40,9	44,1	.5050			

Andere Abmessungen auf Anfrage
Other sizes upon requestProduct
Finderv_c / f_z

M

MF

UNC
UN, UNSUNF
UNEF

G, Rp

NPT, NPTF
Rc, W

BSW, BSF

Pg

EG (STI)
SELF-LOCK

Tr

Zubehör
Accessories

Tech. Info

BGF

ZBGF

GSF

GF

GF-KEG

ZGF

ZIRK-GF

Gigant

MoSys



- Product Finder
- v_c / f_z
- M
- MF
- UNC UN, UNS
- UNF UNEF
- G Rp
- NPT, NPTF Rc, W
- BSW, BSF
- Pg
- EG (STI) SELF-LOCK
- Tr
- Zubehör Accessories
- Tech. Info
- BGF
- ZBGF
- GSF
- GF
- GF-KEG
- ZGF
- ZIRK-GF
- Gigant
- MoSys

G (BSP)

DIN EN ISO 228

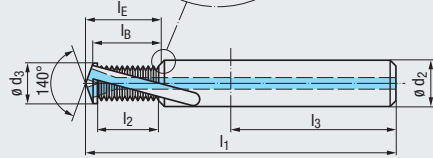
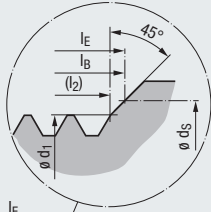
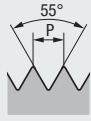

VHM

R30

RH + LH

Z2



DIN 6535



90°



Einsatzgebiete – Material Applications – material » 328

K 1.1-3.2 **N** 1.1-5
N 2.2-3, 2.6 **N** 3.1-2, 4.1

Gewindetiefe Thread depth

1,5 x D

Werkzeug-Ident · Tool ident

	GF422201	GF422501	GF422801
BGF-VHM-Z2 1,5xD R30-IKZ-HB		BGF-VHM-Z2 1,5xD R30-IKZ-HE	BGF-VHM-Z2 1,5xD R30-IKZ-HA
	•	•	•
	•	•	•
	•	•	•

Nenngröße Nom. size

$\varnothing D$	P Gg/1" (tpi)	l_1	l_2	l_3	$\varnothing d_1$	$\varnothing d_2$	$\varnothing d_3$	$\varnothing d_5$	l_B	l_E	Dimens.-Ident
G 1/8	28	79	14,56	45	8,5	12	8,8	10	16,1	17,7	.4035
1/4	19	102	18,77	48	11,4	16	11,8	13,5	21	23,1	.4036
3/8	19	102	25,46	48	14,85	18	15,25	17	27,7	30,5	.4037

Gewindetiefe Thread depth

2 x D

Werkzeug-Ident · Tool ident

	GF432201	GF432501	GF432801
BGF-VHM-Z2 2xD R30-IKZ-HB		BGF-VHM-Z2 2xD R30-IKZ-HE	BGF-VHM-Z2 2xD R30-IKZ-HA
	•	•	•
	•	•	•
	•	•	•

Nenngröße Nom. size

$\varnothing D$	P Gg/1" (tpi)	l_1	l_2	l_3	$\varnothing d_1$	$\varnothing d_2$	$\varnothing d_3$	$\varnothing d_5$	l_B	l_E	Dimens.-Ident
G 1/8	28	79	19,10	45	8,5	12	8,8	10	20,6	22,2	.4035
1/4	19	102	25,46	48	11,4	16	11,8	13,5	27,7	29,8	.4036
3/8	19	102	33,48	48	14,85	18	15,25	17	35,7	38,5	.4037

Andere Abmessungen auf Anfrage
 Other sizes upon request



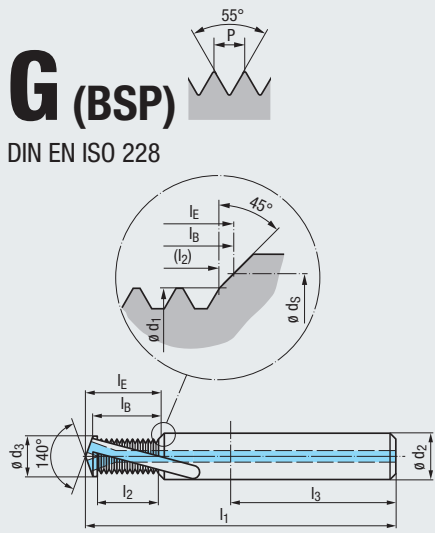

VHM	TICN
R30	RH + LH
Z2	DIN 6535 HB HE HA
90°	ø D

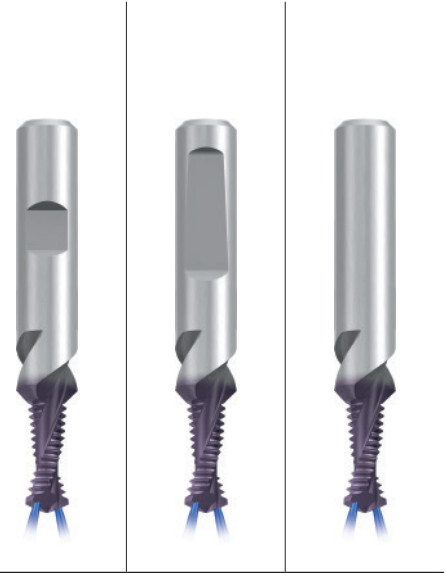

Product Finder

v_c / f_z

M

MF

UNC
UN, UNS

UNF
UNEF

G, Rp

NPT, NPTF
Rc, W

BSW, BSF

Pg

EG (STI)
SELF-LOCK

Tr

Zubehör
Accessories

Tech. Info

BGF

ZBGF

GSF

GF

GF-KEG

ZGF

ZIRK-GF

Gigant

MoSys

Einsatzgebiete – Material Applications – material **328**

K 1.1-3.2 N 1.1-6
N 2.2-3, 2.6 N 3.1-2, 4.1

Gewindetiefe Thread depth

1,5 x D

Werkzeug-Ident · Tool ident												GF422206	GF422506	GF422806
Nenngröße Nom. size											Dimens.-Ident	BGF-VHM-Z2 1,5xD R30-1KZ-HB TICN	BGF-VHM-Z2 1,5xD R30-1KZ-HE TICN	BGF-VHM-Z2 1,5xD R30-1KZ-HA TICN
ø D	P Gg/1" (tpi)	l ₁	l ₂	l ₃	ø d ₁	ø d ₂	ø d ₃	ø d _S	l _B	l _E				
G 1/8	28	79	14,56	45	8,5	12	8,8	10	16,1	17,7	.4035	●	●	●
1/4	19	102	18,77	48	11,4	16	11,8	13,5	21	23,1	.4036	●	●	●
3/8	19	102	25,46	48	14,85	18	15,25	17	27,7	30,5	.4037	●	●	●

Gewindetiefe Thread depth

2 x D

Werkzeug-Ident · Tool ident												GF432206	GF432506	GF432806
Nenngröße Nom. size											Dimens.-Ident	BGF-VHM-Z2 2xD R30-1KZ-HB TICN	BGF-VHM-Z2 2xD R30-1KZ-HE TICN	BGF-VHM-Z2 2xD R30-1KZ-HA TICN
ø D	P Gg/1" (tpi)	l ₁	l ₂	l ₃	ø d ₁	ø d ₂	ø d ₃	ø d _S	l _B	l _E				
G 1/8	28	79	19,10	45	8,5	12	8,8	10	20,6	22,2	.4035	●	●	●
1/4	19	102	25,46	48	11,4	16	11,8	13,5	27,7	29,8	.4036	●	●	●
3/8	19	102	33,48	48	14,85	18	15,25	17	35,7	38,5	.4037	●	●	●

Andere Abmessungen auf Anfrage Other sizes upon request



Gewinde-Tiefenlehndorne siehe Seite 624 - 627

Thread depth plug gauges, see page 624 - 627

● = Lagerwerkzeug, siehe Preisliste · Stock tool, see price list
○ = Kurzfristig lieferbar, Preis auf Anfrage · Available on short notice, price upon inquiry

Product Finder

v_c / f_z

M

MF

UNC
UN, UNS

UNF
UNEF

G, Rp

NPT, NPTF
Rc, W

BSW, BSF

Pg

EG (STI)
SELF-LOCK

Tr

Zubehör
Accessories

Tech. Info

BGF

ZBGF

GSF

GF

GF-KEG

ZGF

ZIRK-GF

Gigant

MoSys



EG M (STI)

DIN 8140-2

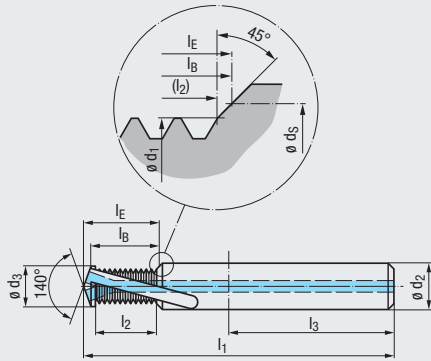

VHM

R30

RH + LH

Z2



DIN 6535

HB
HE
HA

90°



$\varnothing D$

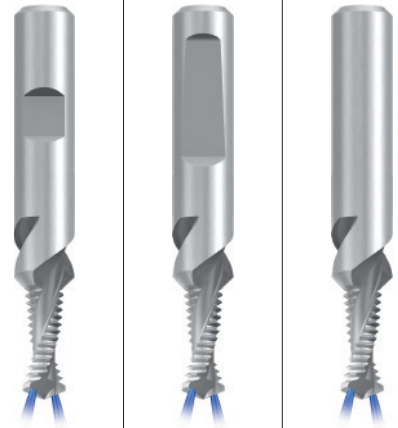

Einsatzgebiete – Material
Applications – material

» 328

K 1.1-3.2 N 1.1-5
N 2.2-3, 2.6 N 3.1-2, 4.1

Gewindetiefe
Thread depth

1,5 x D

Werkzeug-Ident · Tool ident

GF422201 GF422501 GF422801

Nenngröße
Nom. size

Dimens.-
Ident

BGF-VHM-Z2 1,5xD R30-
IKZ-HB BGF-VHM-Z2 1,5xD R30-
IKZ-HE BGF-VHM-Z2 1,5xD R30-
IKZ-HA

$\varnothing D$	P mm	l_1	l_2	l_3	$\varnothing d_1$	$\varnothing d_2$	$\varnothing d_3$	$\varnothing d_S$	l_B	l_E	Dimens.-Ident	GF422201	GF422501	GF422801
EG M 6	1	74	10,10	40	6	10	6,3	7,6	11,8	12,9	.0971	●	●	●
8	1,25	79	12,60	45	8,1	12	8,4	9,9	14,6	16,1	.0973	●	●	●
10	1,5	89	16,63	45	10	14	10,4	12,25	19,1	21	.0975	●	●	●
12	1,75	102	19,38	48	12,1	16	12,5	14,6	22,2	24,5	.0977	●	●	●
14	2	102	22,12	48	14,1	18	14,5	16,9	25,3	28	.0978	●	●	●
16	2	115	26,17	50	16	20	16,5	18,9	29,4	32,4	.0979	●	●	●

Gewindetiefe
Thread depth

2 x D

Werkzeug-Ident · Tool ident

GF432201 GF432501 GF432801

Nenngröße
Nom. size

Dimens.-
Ident

BGF-VHM-Z2 2xD R30-
IKZ-HB BGF-VHM-Z2 2xD R30-
IKZ-HE BGF-VHM-Z2 2xD R30-
IKZ-HA

$\varnothing D$	P mm	l_1	l_2	l_3	$\varnothing d_1$	$\varnothing d_2$	$\varnothing d_3$	$\varnothing d_S$	l_B	l_E	Dimens.-Ident	GF432201	GF432501	GF432801
EG M 6	1	74	13,10	40	6	10	6,3	7,6	14,8	15,9	.0971	●	●	●
8	1,25	79	16,35	45	8,1	12	8,4	9,9	18,4	19,9	.0973	●	●	●
10	1,5	89	21,13	45	10	14	10,4	12,25	23,6	25,5	.0975	●	●	●
12	1,75	102	24,63	48	12,1	16	12,5	14,6	27,5	29,7	.0977	●	●	●
14	2	102	30,12	48	14,1	18	14,5	16,9	33,3	36	.0978	●	●	●
16	2	115	34,17	50	16	20	16,5	18,9	37,4	40,4	.0979	●	●	●

Andere Abmessungen auf Anfrage
Other sizes upon request

EG M (STI)

DIN 8140-2

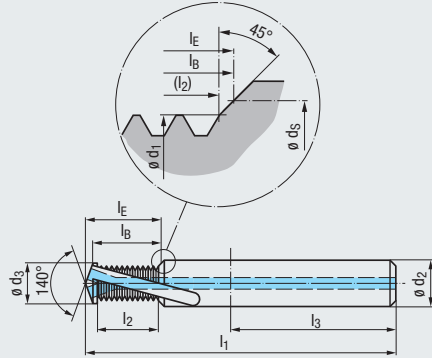

VHM	TICN
R30	RH + LH
Z2	DIN 6535 HB HE HA
90°	ø D

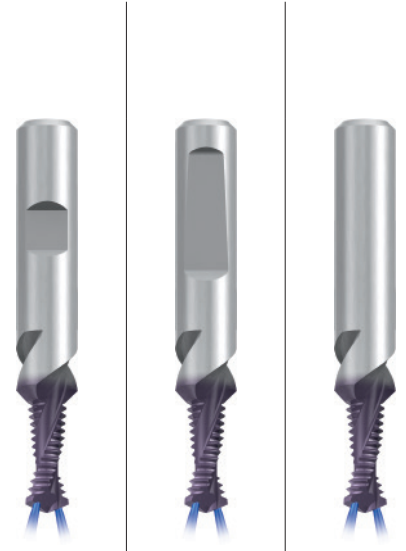

- Product Finder
- v_c / f_z
- M
- MF
- UNC UN, UNS
- UNF UNEF
- G, Rp
- NPT, NPTF Rc, W
- BSW, BSF
- Pg
- EG (STI) SELF-LOCK

Einsatzgebiete – Material Applications – material ▶ 328

K 1.1-3.2 **N** 1.1-6
N 2.2-3, 2.6 **N** 3.1-2, 4.1

Gewindetiefe Thread depth

1,5 x D

Werkzeug-Ident · Tool ident												GF422206	GF422506	GF422806
Nenngröße Nom. size											Dimens.-Ident	BGF-VHM-Z2 1,5xD R30-IKZ-HB TICN	BGF-VHM-Z2 1,5xD R30-IKZ-HE TICN	BGF-VHM-Z2 1,5xD R30-IKZ-HA TICN
ø D	P mm	l ₁	l ₂	l ₃	ø d ₁	ø d ₂	ø d ₃	ø d _S	l _B	l _E				
EG M 6	1	74	10,10	40	6	10	6,3	7,6	11,8	12,9	.0971	●	●	●
8	1,25	79	12,60	45	8,1	12	8,4	9,9	14,6	16,1	.0973	●	●	●
10	1,5	89	16,63	45	10	14	10,4	12,25	19,1	21	.0975	●	●	●
12	1,75	102	19,38	48	12,1	16	12,5	14,6	22,2	24,5	.0977	●	●	●
14	2	102	22,12	48	14,1	18	14,5	16,9	25,3	28	.0978	●	●	●
16	2	115	26,17	50	16	20	16,5	18,9	29,4	32,4	.0979	●	●	●

Gewindetiefe Thread depth

2 x D

Werkzeug-Ident · Tool ident												GF432206	GF432506	GF432806
Nenngröße Nom. size											Dimens.-Ident	BGF-VHM-Z2 2xD R30-IKZ-HB TICN	BGF-VHM-Z2 2xD R30-IKZ-HE TICN	BGF-VHM-Z2 2xD R30-IKZ-HA TICN
ø D	P mm	l ₁	l ₂	l ₃	ø d ₁	ø d ₂	ø d ₃	ø d _S	l _B	l _E				
EG M 6	1	74	13,10	40	6	10	6,3	7,6	14,8	15,9	.0971	●	●	●
8	1,25	79	16,35	45	8,1	12	8,4	9,9	18,4	19,9	.0973	●	●	●
10	1,5	89	21,13	45	10	14	10,4	12,25	23,6	25,5	.0975	●	●	●
12	1,75	102	24,63	48	12,1	16	12,5	14,6	27,5	29,7	.0977	●	●	●
14	2	102	30,12	48	14,1	18	14,5	16,9	33,3	36	.0978	●	●	●
16	2	115	34,17	50	16	20	16,5	18,9	37,4	40,4	.0979	●	●	●

Andere Abmessungen auf Anfrage Other sizes upon request

- Tr
- Zubehör Accessories
- Tech. Info
- BGF
- ZBGF
- GSF
- GF
- GF-KEG
- ZGF
- ZIRK-GF
- Gigant
- MoSys

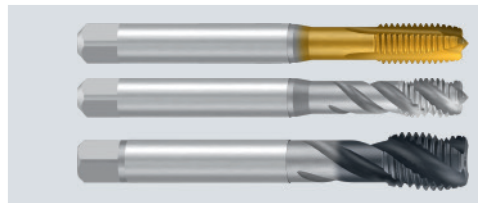

Gewindebohrer für Metrisches EG-Gewinde siehe Seite 216 - 219

Taps for Metric STI thread, see page 216 - 219

● = Lagerwerkzeug, siehe Preisliste · Stock tool, see price list
○ = Kurzfristig lieferbar, Preis auf Anfrage · Available on short notice, price upon inquiry

- Product Finder
- v_c / f_z
- M
- MF
- UNC
UN, UNS
- UNF
UNEF
- G, Rp
- NPT, NPTF
Rc, W
- BSW, BSF
- Pg
- EG (STI)
SELF-LOCK
- Tr
- Zubehör
Accessories
- Tech. Info
- BGF**
- ZBGF
- GSF
- GF
- GF-KEG
- ZGF
- ZIRK-GF
- Gigant
- MoSys
- 



Für die Bearbeitung von Aluminium und Grauguss
For the machining of aluminium and cast iron

ZBGF-T

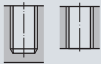

Für die Hartbearbeitung
For hard materials

ZBGF-H

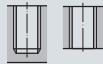

Für die Weichbearbeitung
For soft/unhardened materials

ZBGF-W

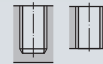

Seite · Page

354	355	355	M, MF
	356	356	UNC
	357	357	UNF

Product Finder

v_c / f_z

M

MF

UNC
UN, UNS

UNF
UNEF

G, Rp

NPT, NPTF
Rc, W

BSW, BSF

Pg

EG (STI)
SELF-LOCK

Tr

Zubehör
Accessories

Tech. Info

BGF

ZBGF

GSF

GF

GF-KEG

ZGF

ZIRK-GF

Gigant

MoSys



Gewindefräszyklus · Thread milling cycle

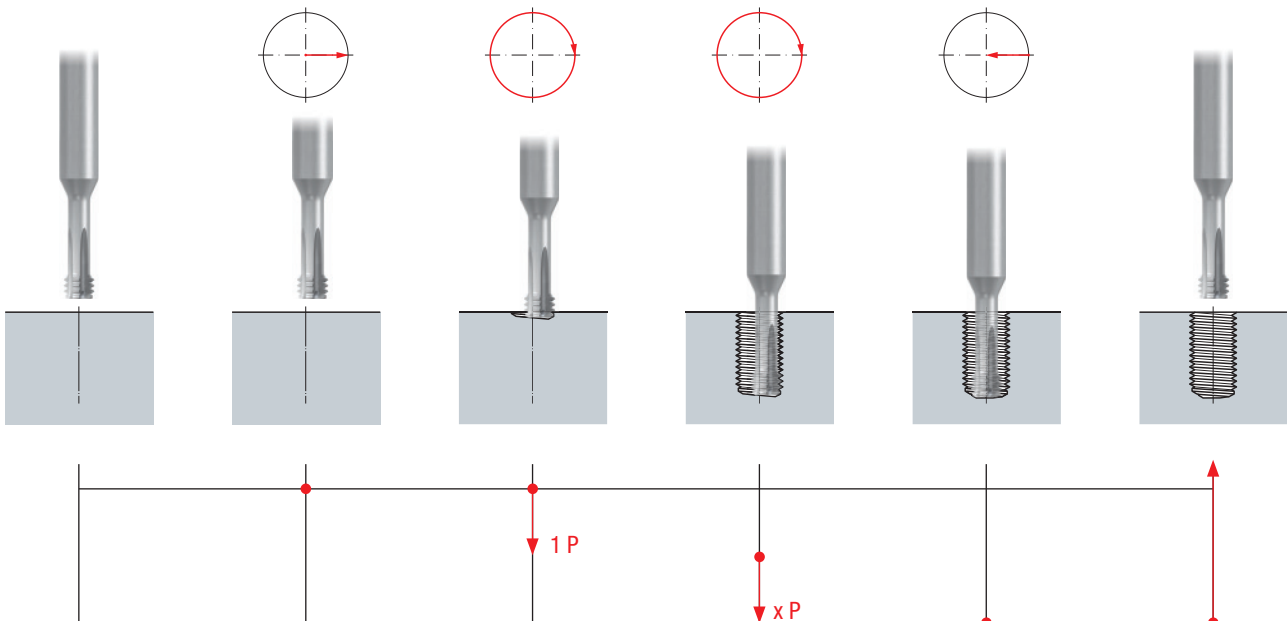

- Product Finder
- v_c / f_z
- M
- MF
- UNC
UN, UNS
- UNF
UNEF
- G, Rp
- NPT, NPTF
Rc, W
- BSW, BSF
- Pg
- EG (STI)
SELF-LOCK
- Tr
- Zubehör
Accessories
- Tech. Info
- BGF
- ZBGF
- GSF
- GF
- GF-KEG
- ZGF
- ZIRK-GF
- Gigant
- MoSys

M, MF

DIN 13

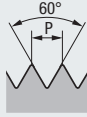

VHM

TICN

RH + LH

RH-rot.

Z3 - Z4

DIN 6535
 HB
 HE
 HA

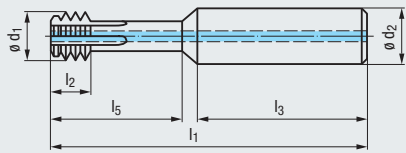

ZBGF-T
Für die Bearbeitung von Aluminium und Grauguss
For the machining of aluminium and cast iron

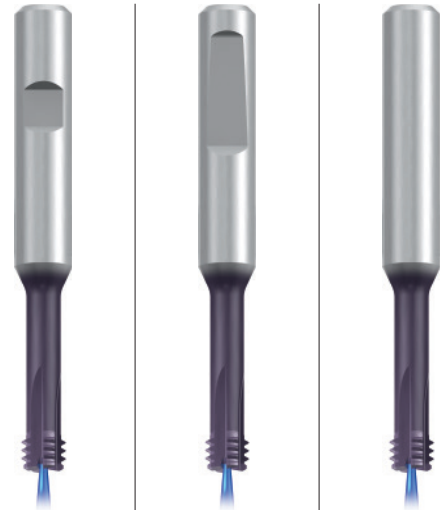

K 1.1-2 **N** 1.1-6, 3.1-2

Einsatzgebiete – Material
Applications – material 328

Gewindetiefe
Thread depth

3 x D

Werkzeug-Ident · Tool ident

P mm	$\varnothing D$	l_1	l_2	l_3	l_5	$\varnothing d_1$	$\varnothing d_2$	Z	Dimens.- Ident	GF753276	GF753576	GF753876
										ZBGF-T-VHM 3xD IKZ-HB TICN	ZBGF-T-VHM 3xD IKZ-HE TICN	ZBGF-T-VHM 3xD IKZ-HA TICN
1	M 6 - M 7	65	4	36	20	4,5	8	3	.0060	●	●	●
1,25	M 8 - M10 x 1,25	80	5	40	27	6,2	10	4	.0080	●	●	●
1,5	M10 - M12 x 1,5	85	6	40	34	7,75	10	4	.0100	●	●	●
1,75	M12	100	7	45	39	9,2	12	4	.0112	●	●	●

Andere Abmessungen auf Anfrage
Other sizes upon request

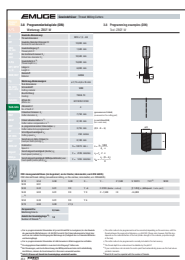

Programmierbeispiel für
Zirkular-Bohrgewindefräser Typ ZBGF
siehe Seite 464

Programming example for
circular drill thread mills type ZBGF,
see page 464

M, MF

DIN 13

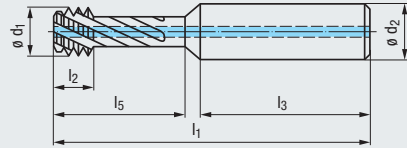
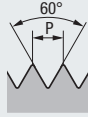

VHM **TIALN T4**

RH + LH **RH-rot.**

R30 **Z3 - Z4**

DIN 6535
HB HE HA

ZBGF-W

Für die Weichbearbeitung
For soft/unhardened materials

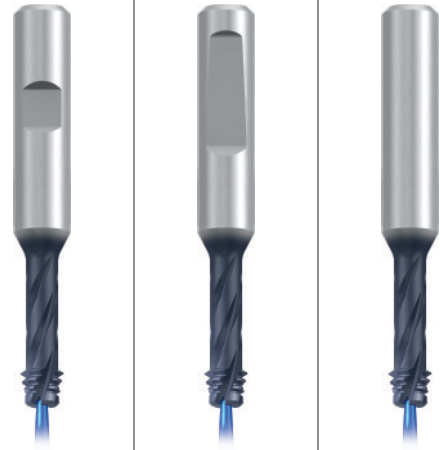

P 1.1-5.1	M 1.1-4.1	K 1.1-4.2
N 1.1-6, 2.1-6	N 3.1-2	N 4.1, 4.3-4
S 1.1-3	S 2.1-2, 2.4	H 1.1-2

Einsatzgebiete – Material
Applications – material **328**

Gewindetiefe
Thread depth

2 x D

Werkzeug-Ident · Tool ident

P mm	ø D	l ₁	l ₂	l ₃	l ₅	ø d ₁	ø d ₂	Z	Dimens.-Ident
1	M 6 - M 7	60	4,6	36	16	4,51	8	3	.0060
1,25	M 8 - M10 x 1,25	71	5,7	40	21	6,23	10	4	.0080
1,5	M10 - M12 x 1,5	76	6,9	40	26	7,75	10	4	.0100
1,75	M12	86	7,9	45	32	9,16	12	4	.0112
2	M14 - M16	98	9,1	48	41	11,08	16	4	.0114

GF732257	GF732557	GF732857
ZBGF-W-VHM 2xD R30- IKZ-HB TIALN-T4	ZBGF-W-VHM 2xD R30- IKZ-HE TIALN-T4	ZBGF-W-VHM 2xD R30- IKZ-HA TIALN-T4
●	●	●
●	●	●
●	●	●
●	●	●
●	●	●

M, MF

DIN 13

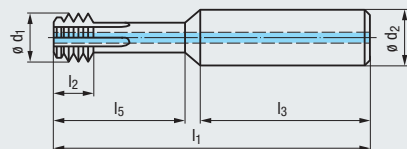
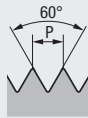

VHM **TIALN T3**

RH **LH-rot.**

Z4

DIN 6535
HB HE HA

ZBGF-H

Für die Hartbearbeitung
For hard materials

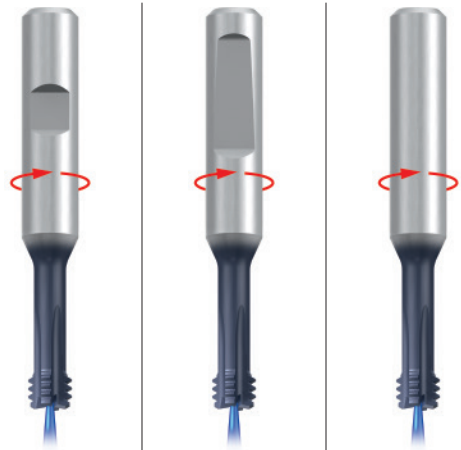

N 2.7-8	H 1.1-5
----------------	----------------

Einsatzgebiete – Material
Applications – material **328**

Gewindetiefe
Thread depth

2 x D

Werkzeug-Ident · Tool ident

P mm	ø D	l ₁	l ₂	l ₃	l ₅	ø d ₁	ø d ₂	Z	Dimens.-Ident
1,25	M 8 - M10 x 1,25	71	5	40	19	6,2	10	4	.0080
1,5	M10 - M12 x 1,5	76	6	40	25	7,75	10	4	.0100
1,75	M12	86	7	45	31	9,2	12	4	.0112
2	M14 - M16	98	8	48	36	11,1	16	4	.0114

GF733208	GF733508	GF733808
ZBGF-H-VHM 2xD IKZ-HB TIALN-T3	ZBGF-H-VHM 2xD IKZ-HE TIALN-T3	ZBGF-H-VHM 2xD IKZ-HA TIALN-T3
●	●	●
●	●	●
●	●	●
●	●	●
●	●	●

Andere Abmessungen auf Anfrage
Other sizes upon request

Product Finder

v_c / f_z

M

MF

UNC UN, UNS

UNF UNEF

G, Rp

NPT, NPTF Rc, W

BSW, BSF

Pg

EG (STI) SELF-LOCK

Tr

Zubehör Accessories

Tech. Info

BGF

ZBGF

GSF

GF

GF-KEG

ZGF

ZIRK-GF

Gigant

MoSys

- Product Finder
- v_c / f_z
- M
- MF
- UNC**
UN, UNS
- UNF
UNEF
- G, Rp
- NPT, NPTF
Rc, W
- BSW, BSF
- Pg
- EG (STI)
SELF-LOCK
- Tr
- Zubehör
Accessories
- Tech. Info
- BGF
- ZBGF**
- GSF
- GF
- GF-KEG
- ZGF
- ZIRK-GF
- Gigant
- MoSys

UNC

ASME B1.1

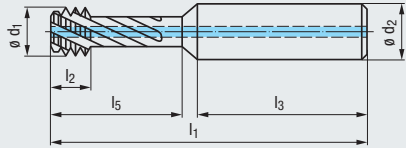
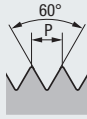

VHM	TIALN T4
RH + LH	RH-rot.
R30	Z3 - Z5
DIN 6535 HB HE HA	$\varnothing D$

ZBGF-W
Für die Weichbearbeitung
For soft/unhardened materials

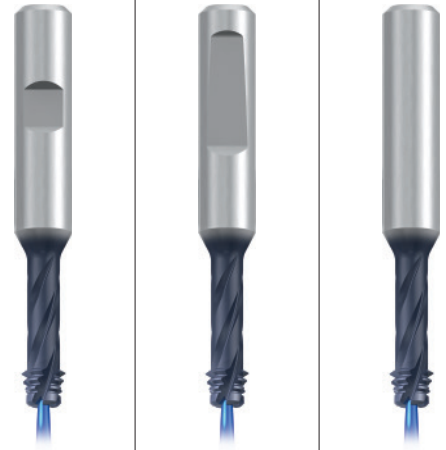

- | | | |
|----------------|--------------|--------------|
| P 1.1-5.1 | M 1.1-4.1 | K 1.1-4.2 |
| N 1.1-6, 2.1-6 | N 3.1-2 | N 4.1, 4.3-4 |
| S 1.1-3 | S 2.1-2, 2.4 | H 1.1-2 |

Einsatzgebiete – Material
Applications – material [» 328](#)

Gewindetiefe
Thread depth

2 x D

Werkzeug-Ident · Tool ident

$\varnothing D$ inch	P Gg/1" (tpi)	l_1	l_2	l_3	l_5	$\varnothing d_1$	$\varnothing d_2$	Z	Dimens.- Ident	GF732257	GF732557	GF732857
										ZBGF-W-VHM 2xD R30-IKZ-HB TIALN-T4	ZBGF-W-VHM 2xD R30-IKZ-HE TIALN-T4	ZBGF-W-VHM 2xD R30-IKZ-HA TIALN-T4
1/4	20	60	5,8	36	17	4,64	8	3	.5009	•	•	•
5/16	18	76	6,4	40	22	5,64	10	4	.5010	•	•	•
3/8	16	76	7,2	40	26	7,16	10	4	.5011	•	•	•
7/16	14	86	8,1	45	31	8,47	12	4	.5012	•	•	•
1/2	13	86	8,9	45	33	10,08	12	4	.5013	•	•	•
5/8	11	98	10,4	48	42	12,89	16	4	.5015	•	•	•
3/4	10	111	11,4	50	51	15,5	20	5	.5016	•	•	•

UNC

ASME B1.1

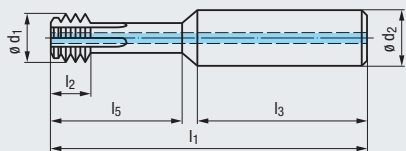
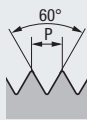

VHM	TIALN T3
RH	LH-rot.
	Z4 - Z5
DIN 6535 HB HE HA	$\varnothing D$

ZBGF-H
Für die Hartbearbeitung
For hard materials

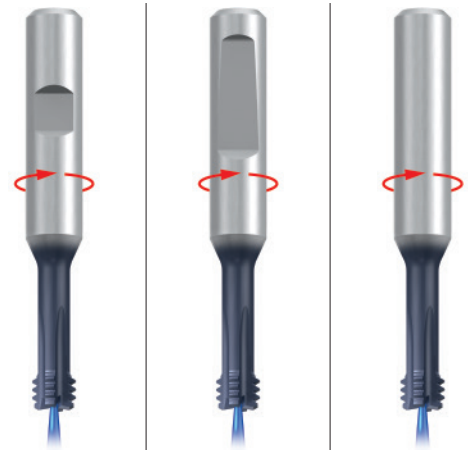

- | | |
|---------|---------|
| N 2.7-8 | H 1.1-5 |
|---------|---------|

Einsatzgebiete – Material
Applications – material [» 328](#)

Gewindetiefe
Thread depth

2 x D

Werkzeug-Ident · Tool ident

$\varnothing D$ inch	P Gg/1" (tpi)	l_1	l_2	l_3	l_5	$\varnothing d_1$	$\varnothing d_2$	Z	Dimens.- Ident	GF733208	GF733508	GF733808
										ZBGF-H-VHM 2xD IKZ-HB TIALN-T3	ZBGF-H-VHM 2xD IKZ-HE TIALN-T3	ZBGF-H-VHM 2xD IKZ-HA TIALN-T3
5/16	18	76	5,6	40	22	5,64	10	4	.5010	•	•	•
3/8	16	76	6,4	40	27	7,16	10	4	.5011	•	•	•
7/16	14	86	7,3	45	31	8,47	12	4	.5012	•	•	•
1/2	13	86	7,8	45	33	10,08	12	4	.5013	•	•	•
5/8	11	98	9,2	48	42	12,89	16	4	.5015	•	•	•
3/4	10	111	10,2	50	51	15,5	20	5	.5016	•	•	•

UNF

ASME B1.1

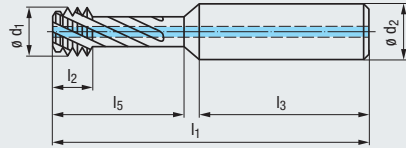

VHM **TIALN T4**

RH + LH **RH-rot.**

R30 **Z3 - Z5**

DIN 6535
HB HE HA

ZBGF-W

Für die Weichbearbeitung
For soft/unhardened materials

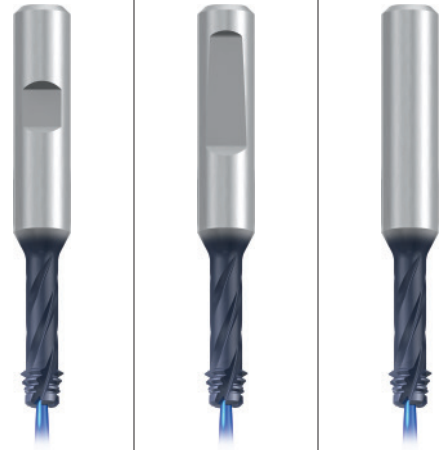

- P** 1.1-5.1 **M** 1.1-4.1 **K** 1.1-4.2
- N** 1.1-6, 2.1-6 **N** 3.1-2 **N** 4.1, 4.3-4
- S** 1.1-3 **S** 2.1-2, 2.4 **H** 1.1-2

Einsatzgebiete – Material
Applications – material » 328

Gewindetiefe
Thread depth

Werkzeug-Ident · Tool ident										Dimens.-Ident
ø D inch	P Gg/1" (tpi)	l ₁	l ₂	l ₃	l ₅	ø d ₁	ø d ₂	Z		
1/4	28	60	4,2	36	17	4,66	8	3		.5043
5/16	24	76	4,8	40	22	5,64	10	4		.5044
3/8	24	76	4,8	40	26	7,14	10	4		.5045
7/16 - 1/2	20	86	5,8	45	33	8,45	12	4		.5046
9/16 - 5/8	18	98	6,4	48	41	11,27	16	4		.5048
3/4	16	111	7,2	50	51	15,38	20	5		.5050

2 x D

GF732257	GF732557	GF732857
ZBGF-W-VHM 2xD R30-IKZ-HB TIALN-T4	ZBGF-W-VHM 2xD R30-IKZ-HE TIALN-T4	ZBGF-W-VHM 2xD R30-IKZ-HA TIALN-T4
•	•	•
•	•	•
•	•	•
•	•	•
•	•	•
•	•	•

UNF

ASME B1.1

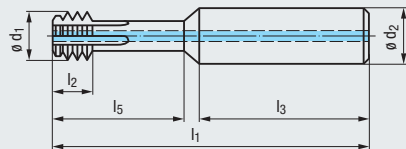
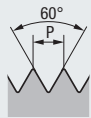

VHM **TIALN T3**

RH **LH-rot.**

Z4 - Z5

DIN 6535
HB HE HA

ZBGF-H

Für die Hartbearbeitung
For hard materials

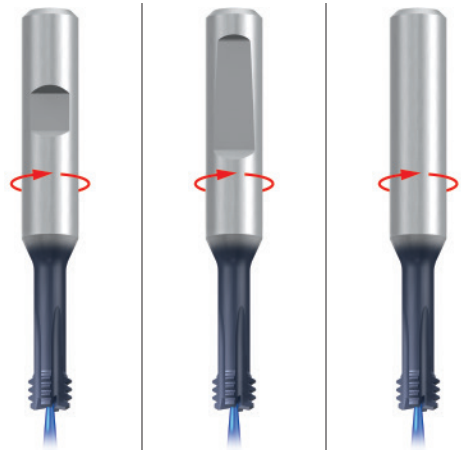

- N** 2.7-8 **H** 1.1-5

Einsatzgebiete – Material
Applications – material » 328

Gewindetiefe
Thread depth

Werkzeug-Ident · Tool ident										Dimens.-Ident
ø D inch	P Gg/1" (tpi)	l ₁	l ₂	l ₃	l ₅	ø d ₁	ø d ₂	Z		
5/16	24	76	4,2	40	22	5,64	10	4		.5044
3/8	24	76	4,2	40	27	7,14	10	4		.5045
7/16 - 1/2	20	86	5,1	45	33	8,45	12	4		.5046
9/16 - 5/8	18	98	5,6	48	41	11,27	16	4		.5048
3/4	16	111	6,4	50	51	15,38	20	5		.5050

2 x D

GF733208	GF733508	GF733808
ZBGF-H-VHM 2xD IKZ-HB TIALN-T3	ZBGF-H-VHM 2xD IKZ-HE TIALN-T3	ZBGF-H-VHM 2xD IKZ-HA TIALN-T3
•	•	•
•	•	•
•	•	•
•	•	•
•	•	•
•	•	•

● = Lagerwerkzeug, siehe Preisliste · Stock tool, see price list
○ = Kurzfristig lieferbar, Preis auf Anfrage · Available on short notice, price upon inquiry

Andere Abmessungen auf Anfrage
Other sizes upon request

Product Finder

v_c / f_z

M

MF

UNC
UN, UNS

UNF
UNEF

G, Rp

NPT, NPTF
Rc, W

BSW, BSF

Pg

EG (STI)
SELF-LOCK

Tr

Zubehör
Accessories

Tech. Info

BGF

ZBGF

GSF

GF

GF-KEG

ZGF

ZIRK-GF

Gigant

MoSys

- Product Finder
- v_c / f_z
- M
- MF
- UNC
UN, UNS
- UNF
UNEF
- G, Rp
- NPT, NPTF
Rc, W
- BSW, BSF
- Pg
- EG (STI)
SELF-LOCK
- Tr
- Zubehör
Accessories
- Tech. Info
- BGF
- ZBGF
- GSF**
- GF
- GF-KEG
- ZGF
- ZIRK-GF
- Gigant
- MoSys

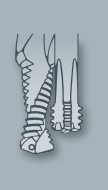

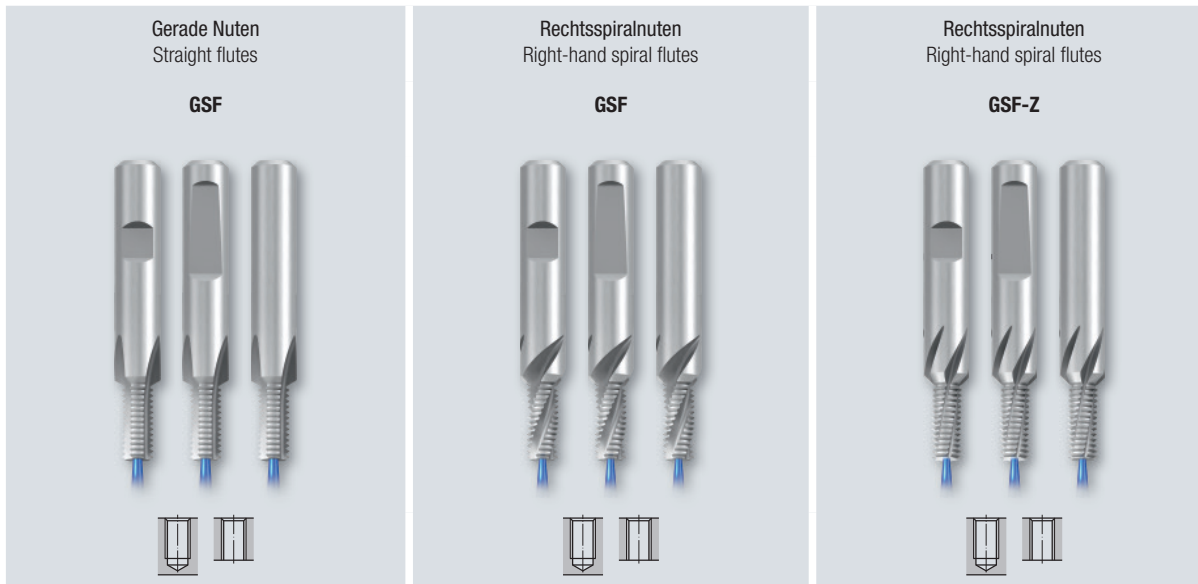

Seite · Page

360 - 361	362 - 363	364 - 365	M
366 - 367	368 - 369	370 - 371	MF
	372 - 373		UNC
	374 - 375		UNF
	376 - 377		G (BSP)
378 - 379			LK-M

Product Finder

v_c / f_z

M

MF

UNC
UN, UNS

UNF
UNEF

G, Rp

NPT, NPTF
Rc, W

BSW, BSF

Pg

EG (STI)
SELF-LOCK

Tr

Zubehör
Accessories

Tech. Info

BGF

ZBGF

GSF

GF

GF-KEG

ZGF

ZIRK-GF

Gigant

MoSys



Mögliche Modifikationen · Possible modifications

- Stirnfase ohne/mit Stirnschnitt
Face chamfer with/without cutting face
- Unvollständigen Gang entfernen
Remove incomplete thread
- Halsfreischliff
Recessed neck
- AZR/AZ (ausgesetzte Zähne)
AZR/AZ (alternating teeth)
- IKZN (innere Kühlschmierstoff-Zufuhr mit Austritt in den Nuten)
IKZN (internal coolant supply exiting in the flutes)
- Schaftkühlfluten
Coolant grooves along the shank

Eine Beschreibung dieser Modifikationsmöglichkeiten finden Sie auf Seite 456 - 457
For a description of these modifications, see pages 456 - 457

Gewindefräszyklus · Thread milling cycle

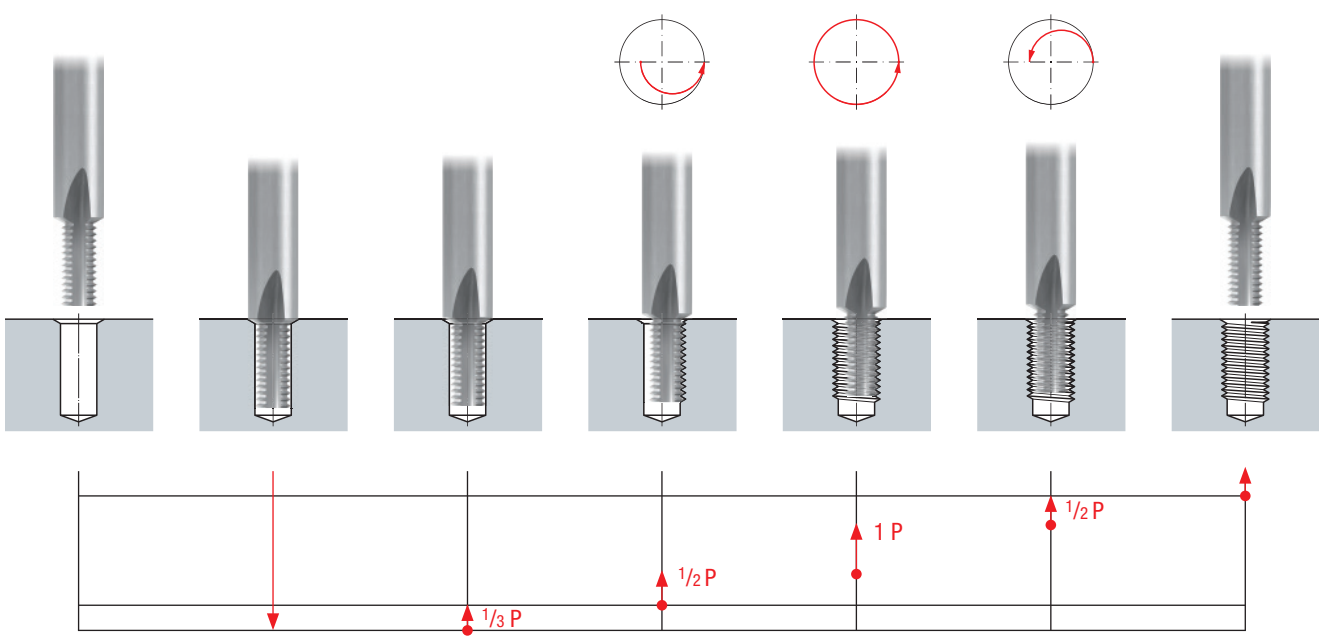

Product Finder

v_c / f_z

M

MF

UNC
UN, UNS

UNF
UNEF

G, Rp

NPT, NPTF
Rc, W

BSW, BSF

Pg

EG (STI)
SELF-LOCK

Tr

Zubehör
Accessories

Tech. Info

BGF

ZBGF

GSF

GF

GF-KEG

ZGF

ZIRK-GF

Gigant

MoSys

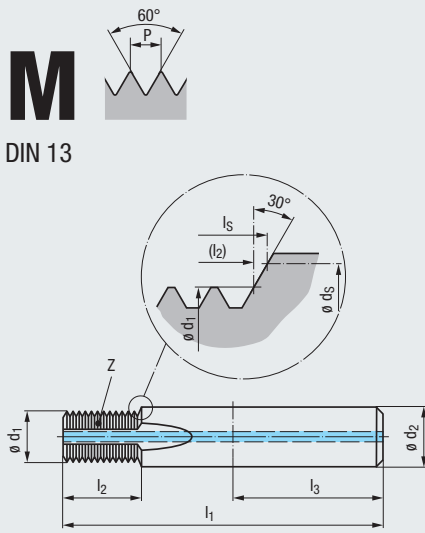

VHM

RH + LH

Z3 - Z4

DIN 6535
HB
HE
HA

120°

$\varnothing D$

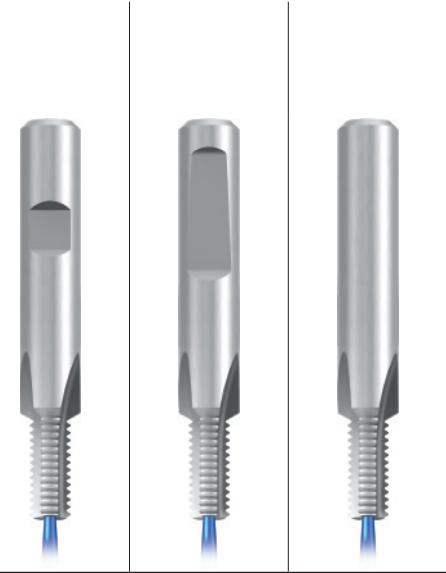

Einsatzgebiete – Material Applications – material » 328

P 1.1-5.1 K 1.1-4.2 N 1.1-5, 2.1-6
N 3.1-2 N 4.1-2, 5.2 S 1.1-3

Gewindetiefe Thread depth

1,5 x D

Werkzeug-Ident · Tool ident											Dimens.-Ident		
$\varnothing D$ mm	P mm	l_1	l_2	l_3	$\varnothing d_1$	$\varnothing d_2$	$\varnothing d_S$	l_S	Z				
M 3	0,5	42	4,7	28	2,4	4	3,3	5	3	.0030	GF323101	GF323401	GF323701
4	0,7	55	5,9	36	3,15	6	4,3	6,3	3	.0040	●	●	●
5	0,8	55	7,6	36	4	6	5,3	7,9	3	.0050	●	●	●
6	1	62	9,5	36	4,8	8	6,3	9,9	3	.0060	●	●	●
8	1,25	74	13,1	40	6,5	10	8,3	13,6	3	.0080	●	●	●
10	1,5	80	15,7	45	8,2	12	10,3	16,3	3	.0100	●	●	●
12	1,75	90	18,3	45	9,9	14	12,3	19	4	.0112	●	●	●
14	2	100	23	48	11,6	16	14,3	23,7	4	.0114	●	●	●
16	2	102	25	48	13,6	18	16,3	25,7	4	.0116	●	●	●

GF323101	GF323401	GF323701
GSF-VHM 1,5xD IKZ-HB	GSF-VHM 1,5xD IKZ-HE	GSF-VHM 1,5xD IKZ-HA
		● ¹⁾
●	●	●
●	●	●
●	●	●
●	●	●
●	●	●
●	●	●
●	●	●
●	●	●
●	●	●

Gewindetiefe Thread depth

2 x D

Werkzeug-Ident · Tool ident											Dimens.-Ident		
$\varnothing D$ mm	P mm	l_1	l_2	l_3	$\varnothing d_1$	$\varnothing d_2$	$\varnothing d_S$	l_S	Z				
M 3	0,5	42	6,2	28	2,4	4	3,3	6,5	3	.0030	GF333101	GF333401	GF333701
4	0,7	55	8,7	36	3,15	6	4,3	9,1	3	.0040	●	●	● ²⁾
5	0,8	55	10,8	36	4	6	5,3	11,1	3	.0050	●	●	●
6	1	62	12,5	36	4,8	8	6,3	12,9	3	.0060	●	●	●
8	1,25	74	16,8	40	6,5	10	8,3	17,4	3	.0080	●	●	●
10	1,5	80	20,2	45	8,2	12	10,3	20,8	3	.0100	●	●	●
12	1,75	90	25,3	45	9,9	14	12,3	26	4	.0112	●	●	●
14	2	100	29	48	11,6	16	14,3	29,7	4	.0114	●	●	●
16	2	102	33	48	13,6	18	16,3	33,7	4	.0116	●	●	●

GF333101	GF333401	GF333701
GSF-VHM 2xD IKZ-HB	GSF-VHM 2xD IKZ-HE	GSF-VHM 2xD IKZ-HA
		● ²⁾
●	●	●
●	●	●
●	●	●
●	●	●
●	●	●
●	●	●
●	●	●
●	●	●
●	●	●

Andere Abmessungen auf Anfrage
Other sizes upon request

¹⁾ M3 ohne innere Kühlschmierstoff-Zufuhr IKZ! Werkzeug-Ident = GF303701
M3 without internal coolant supply IKZ! Tool ident = GF303701

²⁾ M3 ohne innere Kühlschmierstoff-Zufuhr IKZ! Werkzeug-Ident = GF313701
M3 without internal coolant supply IKZ! Tool ident = GF313701

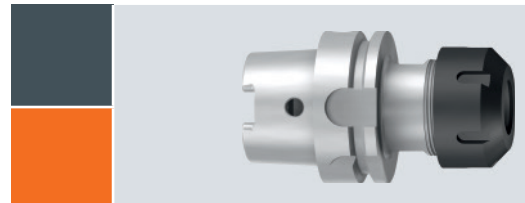

Spannzangen-Aufnahmen
Typ KSN/Synchro
siehe Seite 711 - 713

Collet holders
type KSN/Synchro,
see page 711 - 713

M

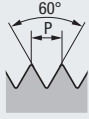

DIN 13

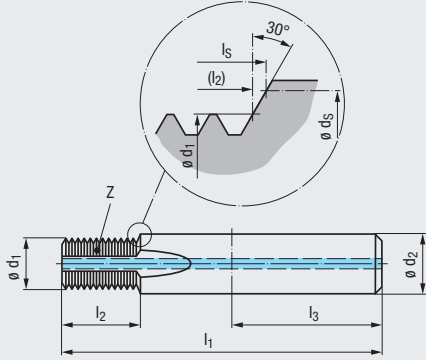

VHM	TICN
	RH + LH
Z3 - Z4	DIN 6535
	HB
	HE
	HA
120°	θD

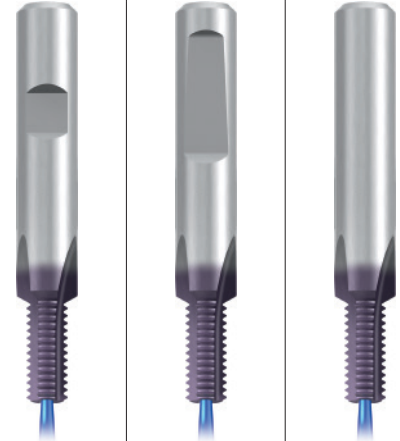

Einsatzgebiete – Material Applications – material

P 1.1-5.1	M 1.1-4.1	K 1.1-4.2
N 1.1-5.2	S 1.1-2.6	H 1.1-2

Gewindetiefe Thread depth

1,5 x D

Werkzeug-Ident · Tool ident

GF323106 GF323406 GF323706

θD mm	P mm	l_1	l_2	l_3	θd_1	θd_2	θd_3	l_s	Z	Dimens.- Ident	GF323106	GF323406	GF323706
											GSF-VHM 1,5xD IKZ-HB TICN	GSF-VHM 1,5xD IKZ-HE TICN	GSF-VHM 1,5xD IKZ-HA TICN
M 3	0,5	42	4,7	28	2,4	4	3,3	5	3	.0030			● ¹⁾
4	0,7	55	5,9	36	3,15	6	4,3	6,3	3	.0040	●	●	●
5	0,8	55	7,6	36	4	6	5,3	7,9	3	.0050	●	●	●
6	1	62	9,5	36	4,8	8	6,3	9,9	3	.0060	●	●	●
8	1,25	74	13,1	40	6,5	10	8,3	13,6	3	.0080	●	●	●
10	1,5	80	15,7	45	8,2	12	10,3	16,3	3	.0100	●	●	●
12	1,75	90	18,3	45	9,9	14	12,3	19	4	.0112	●	●	●
14	2	100	23	48	11,6	16	14,3	23,7	4	.0114	●	●	●
16	2	102	25	48	13,6	18	16,3	25,7	4	.0116	●	●	●

Gewindetiefe Thread depth

2 x D

Werkzeug-Ident · Tool ident

GF333106 GF333406 GF333706

θD mm	P mm	l_1	l_2	l_3	θd_1	θd_2	θd_3	l_s	Z	Dimens.- Ident	GF333106	GF333406	GF333706
											GSF-VHM 2xD IKZ-HB TICN	GSF-VHM 2xD IKZ-HE TICN	GSF-VHM 2xD IKZ-HA TICN
M 3	0,5	42	6,2	28	2,4	4	3,3	6,5	3	.0030			● ²⁾
4	0,7	55	8,7	36	3,15	6	4,3	9,1	3	.0040	●	●	●
5	0,8	55	10,8	36	4	6	5,3	11,1	3	.0050	●	●	●
6	1	62	12,5	36	4,8	8	6,3	12,9	3	.0060	●	●	●
8	1,25	74	16,8	40	6,5	10	8,3	17,4	3	.0080	●	●	●
10	1,5	80	20,2	45	8,2	12	10,3	20,8	3	.0100	●	●	●
12	1,75	90	25,3	45	9,9	14	12,3	26	4	.0112	●	●	●
14	2	100	29	48	11,6	16	14,3	29,7	4	.0114	●	●	●
16	2	102	33	48	13,6	18	16,3	33,7	4	.0116	●	●	●

Andere Abmessungen auf Anfrage Other sizes upon request

1) M3 ohne innere Kühlschmierstoff-Zufuhr IKZ! Werkzeug-Ident = GF303706
M3 without internal coolant supply IKZ! Tool ident = GF303706
2) M3 ohne innere Kühlschmierstoff-Zufuhr IKZ! Werkzeug-Ident = GF313706
M3 without internal coolant supply IKZ! Tool ident = GF313706

Product Finder

v_c / f_z

M

MF

UNC UN, UNS

UNF UNEF

G, Rp

NPT, NPTF Rc, W

BSW, BSF

Pg

EG (STI) SELF-LOCK

Tr

Zubehör Accessories

Tech. Info

BGF

ZBGF

GSF

GF

GF-KEG

ZGF

ZIRK-GF

Gigant

MoSys



Product Finder

v_c / f_z

M

MF

UNC
UN, UNS

UNF
UNEF

G, Rp

NPT, NPTF
Rc, W

BSW, BSF

Pg

EG (STI)
SELF-LOCK

Tr

Zubehör
Accessories

Tech. Info

BGF

ZBGF

GSF

GF

GF-KEG

ZGF

ZIRK-GF

Gigant

MoSys

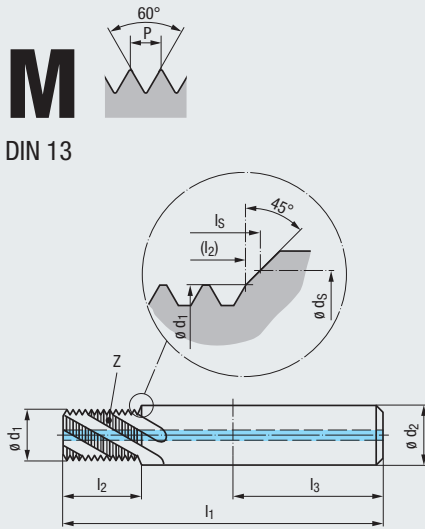
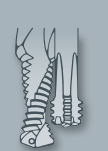

VHM

R30

RH + LH

Z3 - Z4



DIN 6535

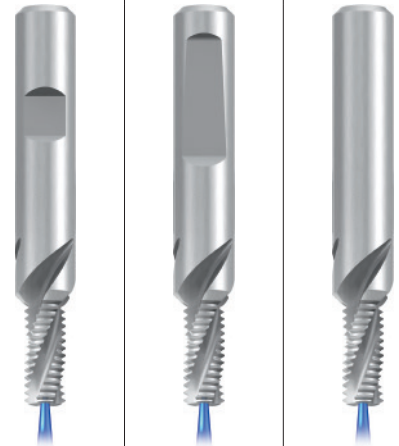
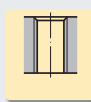
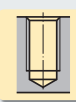

Einsatzgebiete – Material
Applications – material

» 328

P 1.1-3.1 K 1.1-4.2 N 1.1-5
N 2.1-6 N 3.1-4.2, 5.2 S 1.1-2

Gewindetiefe
Thread depth

1,5 x D

Werkzeug-Ident · Tool ident

GF322101 GF322401 GF322701

ø D mm	P mm	l ₁	l ₂	l ₃	ø d ₁	ø d ₂	ø d _s	l _s	Z	Dimens.- Ident	GSF-VHM	GSF-VHM	GSF-VHM
											1,5xD R30- IKZ-HB	1,5xD R30- IKZ-HE	1,5xD R30- IKZ-HA
M 5	0,8	55	7,6	36	4	6	5,3	8,2	3	.0050	•	•	•
6	1	62	9,5	36	4,8	8	6,3	10,2	3	.0060	•	•	•
8	1,25	74	13,1	40	6,5	10	8,3	13,9	3	.0080	•	•	•
10	1,5	80	15,8	45	8,2	12	10,3	16,7	3	.0100	•	•	•
12	1,75	90	18,4	45	9,9	14	12,3	19,5	4	.0112	•	•	•
14	2	100	23	48	11,6	16	14,3	24,2	4	.0114	•	•	•
16	2	102	25	48	13,6	18	16,3	26,2	4	.0116	•	•	•

Gewindetiefe
Thread depth

2 x D

Werkzeug-Ident · Tool ident

GF332101 GF332401 GF332701

ø D mm	P mm	l ₁	l ₂	l ₃	ø d ₁	ø d ₂	ø d _s	l _s	Z	Dimens.- Ident	GSF-VHM	GSF-VHM	GSF-VHM
											2xD R30- IKZ-HB	2xD R30- IKZ-HE	2xD R30- IKZ-HA
M 5	0,8	55	10,8	36	4	6	5,3	11,4	3	.0050	•	•	•
6	1	62	12,5	36	4,8	8	6,3	13,2	3	.0060	•	•	•
8	1,25	74	16,9	40	6,5	10	8,3	17,7	3	.0080	•	•	•
10	1,5	80	20,3	45	8,2	12	10,3	21,2	3	.0100	•	•	•
12	1,75	90	25,4	45	9,9	14	12,3	26,5	4	.0112	•	•	•
14	2	100	29	48	11,6	16	14,3	30,2	4	.0114	•	•	•
16	2	102	33	48	13,6	18	16,3	34,2	4	.0116	•	•	•

Gewindetiefe
Thread depth

2,5 x D

Werkzeug-Ident · Tool ident

GF342101 GF342401 GF342701

ø D mm	P mm	l ₁	l ₂	l ₃	ø d ₁	ø d ₂	ø d _s	l _s	Z	Dimens.- Ident	GSF-VHM	GSF-VHM	GSF-VHM
											2,5xD R30- IKZ-HB	2,5xD R30- IKZ-HE	2,5xD R30- IKZ-HA
M 5	0,8	58	13,2	36	4	6	5,3	13,8	3	.0050	•	•	•
6	1	65	15,5	36	4,8	8	6,3	16,2	3	.0060	•	•	•
8	1,25	78	20,6	40	6,5	10	8,3	21,4	3	.0080	•	•	•
10	1,5	85	26,3	45	8,2	12	10,3	27,2	3	.0100	•	•	•
12	1,75	95	30,7	45	9,9	14	12,3	31,7	4	.0112	•	•	•
14	2	110	37	48	11,6	16	14,3	38,2	4	.0114	•	•	•
16	2	110	41	48	13,6	18	16,3	42,2	4	.0116	•	•	•

Andere Abmessungen auf Anfrage
Other sizes upon request

M



DIN 13

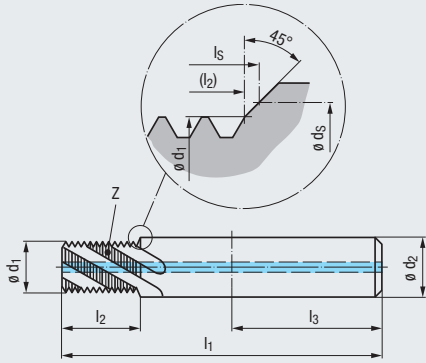

VHM	TICN
R30	RH + LH
Z3 - Z4	DIN 6535 HB HE HA
90°	θD

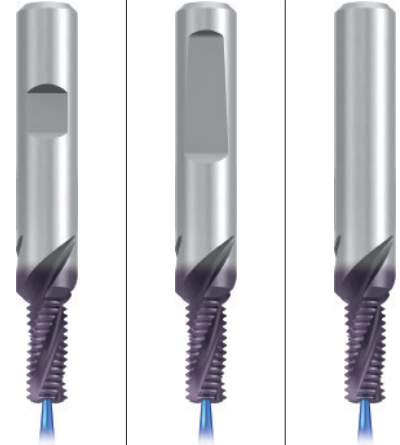

Einsatzgebiete – Material Applications – material **328**

P 1.1-3.1 M 1.1-2.1 K 1.1-4.2
N 1.1-2.7 N 3.1-5.2 S 1.1-2.2.1

Gewindetiefe Thread depth

1,5 x D

Werkzeug-Ident · Tool ident

θD mm	P mm	l_1	l_2	l_3	θd_1	θd_2	θd_3	l_s	Z	Dimens.- Ident	GF322106	GF322406	GF322706
											GSF-VHM 1,5xD R30-1KZ-HB TICN	GSF-VHM 1,5xD R30-1KZ-HE TICN	GSF-VHM 1,5xD R30-1KZ-HA TICN
M 5	0,8	55	7,6	36	4	6	5,3	8,2	3	.0050	●	●	●
6	1	62	9,5	36	4,8	8	6,3	10,2	3	.0060	●	●	●
8	1,25	74	13,1	40	6,5	10	8,3	13,9	3	.0080	●	●	●
10	1,5	80	15,8	45	8,2	12	10,3	16,7	3	.0100	●	●	●
12	1,75	90	18,4	45	9,9	14	12,3	19,5	4	.0112	●	●	●
14	2	100	23	48	11,6	16	14,3	24,2	4	.0114	●	●	●
16	2	102	25	48	13,6	18	16,3	26,2	4	.0116	●	●	●

Gewindetiefe Thread depth

2 x D

Werkzeug-Ident · Tool ident

θD mm	P mm	l_1	l_2	l_3	θd_1	θd_2	θd_3	l_s	Z	Dimens.- Ident	GF332106	GF332406	GF332706
											GSF-VHM 2xD R30-1KZ-HB TICN	GSF-VHM 2xD R30-1KZ-HE TICN	GSF-VHM 2xD R30-1KZ-HA TICN
M 5	0,8	55	10,8	36	4	6	5,3	11,4	3	.0050	●	●	●
6	1	62	12,5	36	4,8	8	6,3	13,2	3	.0060	●	●	●
8	1,25	74	16,9	40	6,5	10	8,3	17,7	3	.0080	●	●	●
10	1,5	80	20,3	45	8,2	12	10,3	21,2	3	.0100	●	●	●
12	1,75	90	25,4	45	9,9	14	12,3	26,5	4	.0112	●	●	●
14	2	100	29	48	11,6	16	14,3	30,2	4	.0114	●	●	●
16	2	102	33	48	13,6	18	16,3	34,2	4	.0116	●	●	●

Gewindetiefe Thread depth

2,5 x D

Werkzeug-Ident · Tool ident

θD mm	P mm	l_1	l_2	l_3	θd_1	θd_2	θd_3	l_s	Z	Dimens.- Ident	GF342106	GF342406	GF342706
											GSF-VHM 2,5xD R30-1KZ-HB TICN	GSF-VHM 2,5xD R30-1KZ-HE TICN	GSF-VHM 2,5xD R30-1KZ-HA TICN
M 5	0,8	58	13,2	36	4	6	5,3	13,8	3	.0050	●	●	●
6	1	65	15,5	36	4,8	8	6,3	16,2	3	.0060	●	●	●
8	1,25	78	20,6	40	6,5	10	8,3	21,4	3	.0080	●	●	●
10	1,5	85	26,3	45	8,2	12	10,3	27,2	3	.0100	●	●	●
12	1,75	95	30,7	45	9,9	14	12,3	31,7	4	.0112	●	●	●
14	2	110	37	48	11,6	16	14,3	38,2	4	.0114	●	●	●
16	2	110	41	48	13,6	18	16,3	42,2	4	.0116	●	●	●

Andere Abmessungen auf Anfrage
Other sizes upon request

Product Finder

v_c / f_z

M

MF

UNC
UN, UNS

UNF
UNEF

G, Rp

NPT, NPTF
Rc, W

BSW, BSF

Pg

EG (STI)
SELF-LOCK

Tr

Zubehör
Accessories

Tech. Info

BGF

ZBGF

GSF

GF

GF-KEG

ZGF

ZIRK-GF

Gigant

MoSys

- Product Finder
- v_c / f_z
- M
- MF
- UNC UN, UNS
- UNF UNEF
- G, Rp
- NPT, NPTF Rc, W
- BSW, BSF
- Pg
- EG (STI) SELF-LOCK
- Tr
- Zubehör Accessories
- Tech. Info
- BGF
- ZBGF
- GSF
- GF
- GF-KEG
- ZGF
- ZIRK-GF
- Gigant
- MoSys

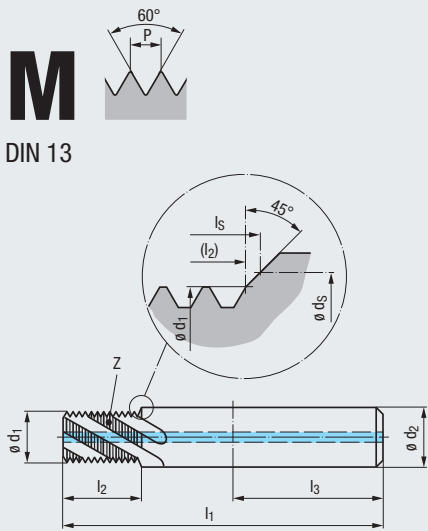

VHM

R15 **RH + LH**

Z4 - Z5 **DIN 6535**
 HB
 HE
 HA

90° $\varnothing D$

Mit höherer Nutenzahl
With increased number of flutes

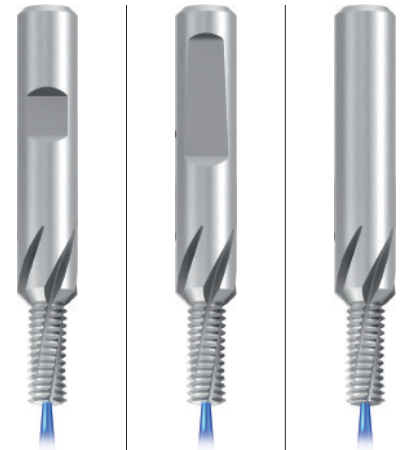

Einsatzgebiete – Material Applications – material \gg 328

P 1.1-5.1 **K** 1.1-4.2 **N** 1.1-5, 2.1-6
N 3.1-2 **N** 4.1-2, 5.2 **S** 1.1-3

Gewindetiefe Thread depth

2 x D

Werkzeug-Ident · Tool ident

	GF335121	GF335421	GF335721
GSF-Z-VHM 2xD R15- IKZ-HB	●	●	●
GSF-Z-VHM 2xD R15- IKZ-HE	●	●	●
GSF-Z-VHM 2xD R15- IKZ-HA	●	●	●

	$\varnothing D$ mm	P mm	Dimens.-Ident							Z	
			l_1	l_2	l_3	$\varnothing d_1$	$\varnothing d_2$	$\varnothing d_3$	l_s		
M	6	1	62	12,5	36	4,8	8	6,3	13,2	4	.0060
	8	1,25	74	16,9	40	6,5	10	8,3	17,7	4	.0080
	10	1,5	80	20,3	45	8,2	12	10,3	21,2	5	.0100
	12	1,75	90	25,4	45	9,9	14	12,3	26,5	5	.0112

Andere Abmessungen auf Anfrage
Other sizes upon request

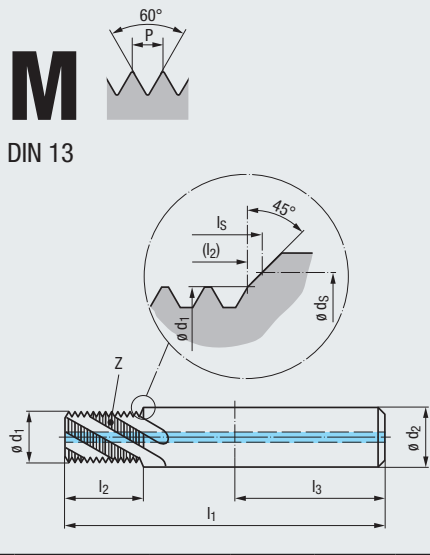

VHM	TICN
R15	RH + LH
Z4 - Z5	DIN 6535 HB HE HA
90°	ϕD

Mit höherer Nutenzahl
With increased number of flutes

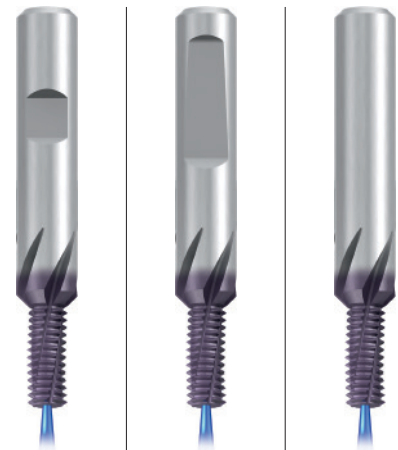

- Product Finder
- v_c / f_z
- M
- MF
- UNC
UN, UNS
- UNF
UNEF
- G, Rp
- NPT, NPTF
Rc, W
- BSW, BSF
- Pg
- EG (STI)
SELF-LOCK
- Tr
- Zubehör
Accessories
- Tech. Info
- BGF
- ZBGF
- GSF
- GF
- GF-KEG
- ZGF
- ZIRK-GF
- Gigant
- MoSys

Einsatzgebiete – Material
Applications – material ▶▶ 328

P 1.1-5.1	M 1.1-4.1	K 1.1-4.2
N 1.1-5.2	S 1.1-2.6	H 1.1-2

Gewindetiefe
Thread depth

2 x D

Werkzeug-Ident · Tool ident

	GF335126	GF335426	GF335726
GSF-Z-VHM 2xD R15-1KZ-HB TICN	●	●	●
GSF-Z-VHM 2xD R15-1KZ-HE TICN	●	●	●
GSF-Z-VHM 2xD R15-1KZ-HA TICN	●	●	●

	ϕD mm	P mm	l_1	l_2	l_3	ϕd_1	ϕd_2	ϕd_3	l_s	Z	Dimens.- Ident
M	6	1	62	12,5	36	4,8	8	6,3	13,2	4	.0060
	8	1,25	74	16,9	40	6,5	10	8,3	17,7	4	.0080
	10	1,5	80	20,3	45	8,2	12	10,3	21,2	5	.0100
	12	1,75	90	25,4	45	9,9	14	12,3	26,5	5	.0112

Andere Abmessungen auf Anfrage
Other sizes upon request

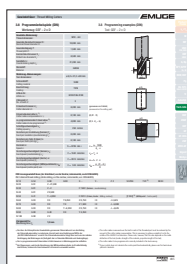

Programmierbeispiel für Gewindefräser mit Senkfase Typ GSF siehe Seite 465

Programming example for thread milling cutters with countersinking step type GSF, see page 465

Product Finder

v_c / f_z

M

MF

UNC
UN, UNS

UNF
UNEF

G, Rp

NPT, NPTF
Rc, W

BSW, BSF

Pg

EG (STI)
SELF-LOCK

Tr

Zubehör
Accessories

Tech. Info

BGF

ZBGF

GSF

GF

GF-KEG

ZGF

ZIRK-GF

Gigant

MoSys

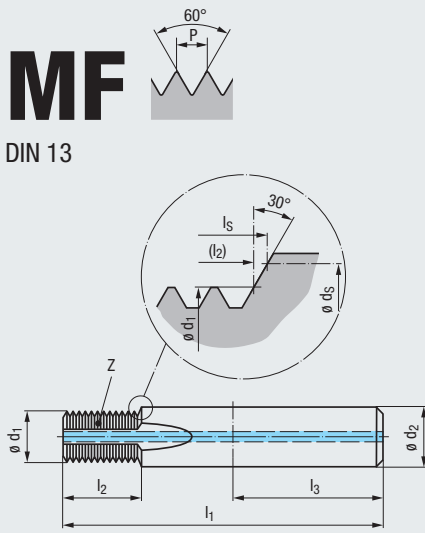

VHM

RH + LH

Z3 - Z4

DIN 6535
HB
HE
HA

120°

$\varnothing D$

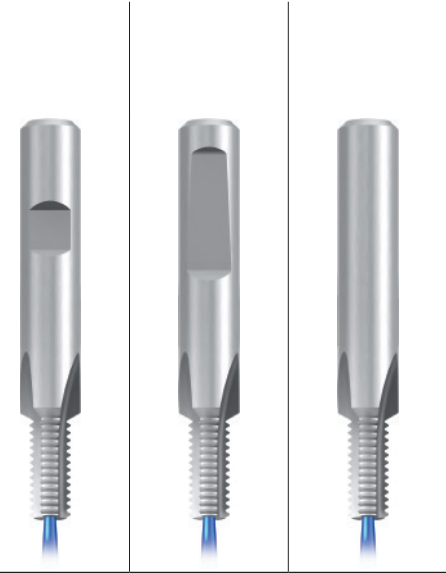

Einsatzgebiete – Material
Applications – material **328**

P 1.1-5.1 K 1.1-4.2 N 1.1-5, 2.1-6
N 3.1-2 N 4.1-2, 5.2 S 1.1-3

Gewindetiefe
Thread depth

1,5 x D

Werkzeug-Ident · Tool ident

	GF323101	GF323401	GF323701
GSF-VHM 1,5xD IKZ-HB	●	●	●
GSF-VHM 1,5xD IKZ-HE	●	●	●
GSF-VHM 1,5xD IKZ-HA	●	●	●

$\varnothing D$ mm	P mm	l_1	l_2	l_3	$\varnothing d_1$	$\varnothing d_2$	$\varnothing d_s$	l_s	Z	Dimens.-Ident
M 6	x 0,75	62	9,4	36	5	8	6,3	9,7	3	.0229
8	x 1	74	12,5	40	6,7	10	8,3	12,9	3	.0251
10	x 1	80	15,5	45	8,7	12	10,3	15,9	3	.0276
10	x 1,25	80	15,6	45	8,4	12	10,3	16,1	3	.0277
12	x 1	90	18,5	45	10,6	14	12,3	19	4	.0301
12	x 1,25	90	18,1	45	10,4	14	12,3	18,6	4	.0302
12	x 1,5	90	18,7	45	10,1	14	12,3	19,3	4	.0303
14	x 1,5	100	21,7	48	12,1	16	14,3	22,3	4	.0331
16	x 1,5	102	24,7	48	14	18	16,3	25,4	4	.0359

Gewindetiefe
Thread depth

2 x D

Werkzeug-Ident · Tool ident

	GF333101	GF333401	GF333701
GSF-VHM 2xD IKZ-HB	●	●	●
GSF-VHM 2xD IKZ-HE	●	●	●
GSF-VHM 2xD IKZ-HA	●	●	●

$\varnothing D$ mm	P mm	l_1	l_2	l_3	$\varnothing d_1$	$\varnothing d_2$	$\varnothing d_s$	l_s	Z	Dimens.-Ident
M 6	x 0,75	62	12,4	36	5	8	6,3	12,7	3	.0229
8	x 1	74	16,5	40	6,7	10	8,3	16,9	3	.0251
10	x 1	80	20,5	45	8,7	12	10,3	20,9	3	.0276
10	x 1,25	80	20,6	45	8,4	12	10,3	21,1	3	.0277
12	x 1	90	24,5	45	10,6	14	12,3	25	4	.0301
12	x 1,25	90	24,3	45	10,4	14	12,3	24,9	4	.0302
12	x 1,5	90	24,7	45	10,1	14	12,3	25,3	4	.0303
14	x 1,5	100	29,2	48	12,1	16	14,3	29,8	4	.0331
16	x 1,5	102	32,2	48	14	18	16,3	32,9	4	.0359

Andere Abmessungen auf Anfrage
Other sizes upon request

MF

DIN 13

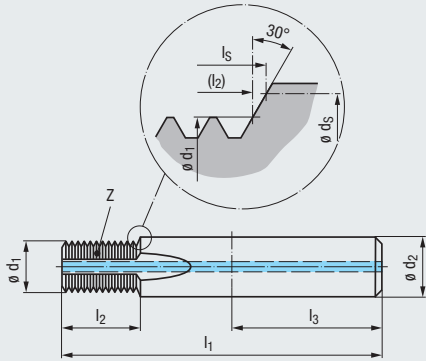

VHM **TICN**

RH + LH

Z3 - Z4 **DIN 6535**
 HB
 HE
 HA

120° **θD**

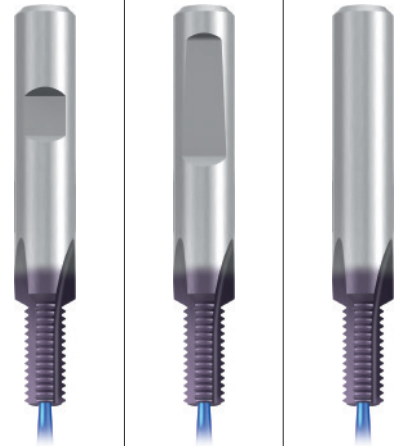

Einsatzgebiete – Material Applications – material 328

P 1.1-5.1 **M** 1.1-4.1 **K** 1.1-4.2
N 1.1-5.2 **S** 1.1-2.6 **H** 1.1-2

Gewindetiefe Thread depth

1,5 x D

Werkzeug-Ident · Tool ident

GF323106 GF323406 GF323706

	θD mm	P mm	l_1	l_2	l_3	θd_1	θd_2	θd_3	l_s	Z	Dimens.- Ident	GF323106	GF323406	GF323706
												GSF-VHM 1,5xD IKZ-HB TICN	GSF-VHM 1,5xD IKZ-HE TICN	GSF-VHM 1,5xD IKZ-HA TICN
M	6	x 0,75	62	9,4	36	5	8	6,3	9,7	3	.0229	●	●	●
	8	x 1	74	12,5	40	6,7	10	8,3	12,9	3	.0251	●	●	●
	10	x 1	80	15,5	45	8,7	12	10,3	15,9	3	.0276	●	●	●
	10	x 1,25	80	15,6	45	8,4	12	10,3	16,1	3	.0277	●	●	●
	12	x 1	90	18,5	45	10,6	14	12,3	19	4	.0301	●	●	●
	12	x 1,25	90	18,1	45	10,4	14	12,3	18,6	4	.0302	●	●	●
	12	x 1,5	90	18,7	45	10,1	14	12,3	19,3	4	.0303	●	●	●
	14	x 1,5	100	21,7	48	12,1	16	14,3	22,3	4	.0331	●	●	●
	16	x 1,5	102	24,7	48	14	18	16,3	25,4	4	.0359	●	●	●

Gewindetiefe Thread depth

2 x D

Werkzeug-Ident · Tool ident

GF333106 GF333406 GF333706

	θD mm	P mm	l_1	l_2	l_3	θd_1	θd_2	θd_3	l_s	Z	Dimens.- Ident	GF333106	GF333406	GF333706
												GSF-VHM 2xD IKZ-HB TICN	GSF-VHM 2xD IKZ-HE TICN	GSF-VHM 2xD IKZ-HA TICN
M	6	x 0,75	62	12,4	36	5	8	6,3	12,7	3	.0229	●	●	●
	8	x 1	74	16,5	40	6,7	10	8,3	16,9	3	.0251	●	●	●
	10	x 1	80	20,5	45	8,7	12	10,3	20,9	3	.0276	●	●	●
	10	x 1,25	80	20,6	45	8,4	12	10,3	21,1	3	.0277	●	●	●
	12	x 1	90	24,5	45	10,6	14	12,3	25	4	.0301	●	●	●
	12	x 1,25	90	24,3	45	10,4	14	12,3	24,9	4	.0302	●	●	●
	12	x 1,5	90	24,7	45	10,1	14	12,3	25,3	4	.0303	●	●	●
	14	x 1,5	100	29,2	48	12,1	16	14,3	29,8	4	.0331	●	●	●
	16	x 1,5	102	32,2	48	14	18	16,3	32,9	4	.0359	●	●	●

Andere Abmessungen auf Anfrage
 Other sizes upon request

Product Finder

v_c / f_z

M

MF

UNC
UN, UNS

UNF
UNEF

G, Rp

NPT, NPTF
Rc, W

BSW, BSF

Pg

EG (STI)
SELF-LOCK

Tr

Zubehör
Accessories

Tech. Info

BGF

ZBGF

GSF

GF

GF-KEG

ZGF

ZIRK-GF

Gigant

MoSys

Product Finder

v_c / f_z

M

MF

UNC
UN, UNS

UNF
UNEF

G, Rp

NPT, NPTF
Rc, W

BSW, BSF

Pg

EG (STI)
SELF-LOCK

Tr

Zubehör
Accessories

Tech. Info

BGF

ZBGF

GSF

GF

GF-KEG

ZGF

ZIRK-GF

Gigant

MoSys

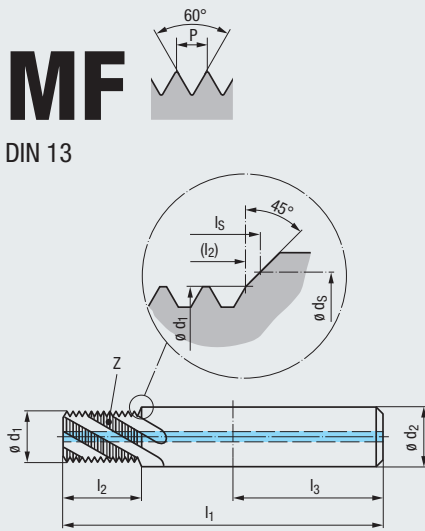

VHM

R30 RH + LH

Z3 - Z4
DIN 6535
HB
HE
HA

90° $\varnothing D$

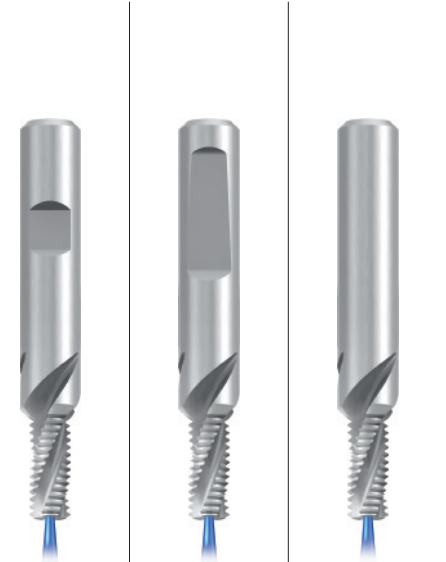
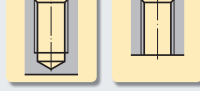

Einsatzgebiete – Material
Applications – material » 328

P 1.1-3.1 K 1.1-4.2 N 1.1-5
N 2.1-6 N 3.1-4.2, 5.2 S 1.1-2

Gewindetiefe
Thread depth

1,5 x D

Werkzeug-Ident · Tool ident

GF322101 GF322401 GF322701

$\varnothing D$ mm	P mm	l_1	l_2	l_3	$\varnothing d_1$	$\varnothing d_2$	$\varnothing d_s$	l_s	Z	Dimens.- Ident	GSF-VHM	GSF-VHM	GSF-VHM
											1,5xD R30-IKZ-HB	1,5xD R30-IKZ-HE	1,5xD R30-IKZ-HA
M 6	x 0,75	62	9,4	36	5	8	6,3	10	3	.0229	●	●	●
8	x 1	74	12,5	40	6,7	10	8,3	13,2	3	.0251	●	●	●
10	x 1	80	15,5	45	8,7	12	10,3	16,2	3	.0276	●	●	●
10	x 1,25	80	15,7	45	8,4	12	10,3	16,5	3	.0277	●	●	●
12	x 1	90	18,5	45	10,6	14	12,3	19,3	4	.0301	●	●	●
12	x 1,25	90	18,2	45	10,4	14	12,3	19	4	.0302	●	●	●
12	x 1,5	90	18,8	45	10,1	14	12,3	19,7	4	.0303	●	●	●
14	x 1,5	100	21,8	48	12,1	16	14,3	22,7	4	.0331	●	●	●
16	x 1,5	102	24,8	48	14	18	16,3	25,8	4	.0359	●	●	●

Gewindetiefe
Thread depth

2 x D

Werkzeug-Ident · Tool ident

GF332101 GF332401 GF332701

$\varnothing D$ mm	P mm	l_1	l_2	l_3	$\varnothing d_1$	$\varnothing d_2$	$\varnothing d_s$	l_s	Z	Dimens.- Ident	GSF-VHM	GSF-VHM	GSF-VHM
											2xD R30-IKZ-HB	2xD R30-IKZ-HE	2xD R30-IKZ-HA
M 6	x 0,75	62	12,4	36	5	8	6,3	13	3	.0229	●	●	●
8	x 1	74	16,5	40	6,7	10	8,3	17,2	3	.0251	●	●	●
10	x 1	80	20,5	45	8,7	12	10,3	21,2	3	.0276	●	●	●
10	x 1,25	80	20,7	45	8,4	12	10,3	21,5	3	.0277	●	●	●
12	x 1	90	24,5	45	10,6	14	12,3	25,3	4	.0301	●	●	●
12	x 1,25	90	24,4	45	10,4	14	12,3	25,2	4	.0302	●	●	●
12	x 1,5	90	24,8	45	10,1	14	12,3	25,7	4	.0303	●	●	●
14	x 1,5	100	29,3	48	12,1	16	14,3	30,2	4	.0331	●	●	●
16	x 1,5	102	32,3	48	14	18	16,3	33,3	4	.0359	●	●	●

Andere Abmessungen auf Anfrage
Other sizes upon request

MF



DIN 13

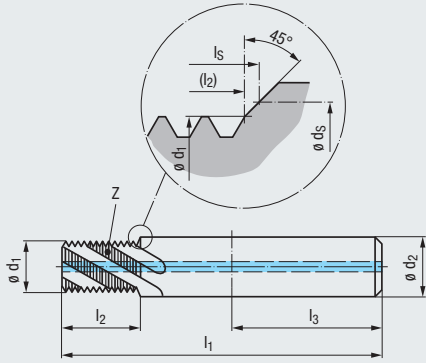

VHM	TICN
R30	RH + LH
Z3 - Z4	DIN 6535 HB HE HA
90°	$\varnothing D$

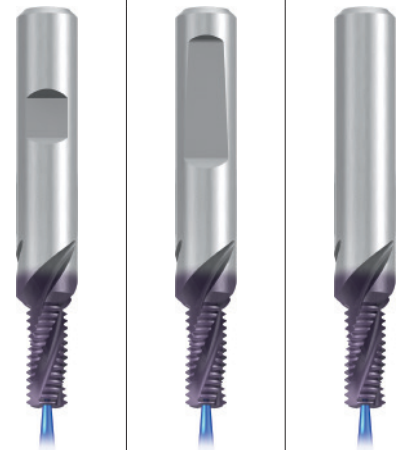

Einsatzgebiete – Material Applications – material **328**

P 1.1-3.1	M 1.1-2.1	K 1.1-4.2
N 1.1-2.7	N 3.1-5.2	S 1.1-2.2.1

Gewindetiefe Thread depth

1,5 x D

Werkzeug-Ident · Tool ident

$\varnothing D$ mm	P mm	l_1	l_2	l_3	$\varnothing d_1$	$\varnothing d_2$	$\varnothing d_s$	l_s	Z	Dimens.- Ident	GF322106	GF322406	GF322706
											GSF-VHM 1,5xD R30-1KZ-HB TICN	GSF-VHM 1,5xD R30-1KZ-HE TICN	GSF-VHM 1,5xD R30-1KZ-HA TICN
M 6 x 0,75	62	9,4	36	5	8	6,3	10	3	.0229	●	●	●	
8 x 1	74	12,5	40	6,7	10	8,3	13,2	3	.0251	●	●	●	
10 x 1	80	15,5	45	8,7	12	10,3	16,2	3	.0276	●	●	●	
10 x 1,25	80	15,7	45	8,4	12	10,3	16,5	3	.0277	●	●	●	
12 x 1	90	18,5	45	10,6	14	12,3	19,3	4	.0301	●	●	●	
12 x 1,25	90	18,2	45	10,4	14	12,3	19	4	.0302	●	●	●	
12 x 1,5	90	18,8	45	10,1	14	12,3	19,7	4	.0303	●	●	●	
14 x 1,5	100	21,8	48	12,1	16	14,3	22,7	4	.0331	●	●	●	
16 x 1,5	102	24,8	48	14	18	16,3	25,8	4	.0359	●	●	●	

Gewindetiefe Thread depth

2 x D

Werkzeug-Ident · Tool ident

$\varnothing D$ mm	P mm	l_1	l_2	l_3	$\varnothing d_1$	$\varnothing d_2$	$\varnothing d_s$	l_s	Z	Dimens.- Ident	GF332106	GF332406	GF332706
											GSF-VHM 2xD R30-1KZ-HB TICN	GSF-VHM 2xD R30-1KZ-HE TICN	GSF-VHM 2xD R30-1KZ-HA TICN
M 6 x 0,75	62	12,4	36	5	8	6,3	13	3	.0229	●	●	●	
8 x 1	74	16,5	40	6,7	10	8,3	17,2	3	.0251	●	●	●	
10 x 1	80	20,5	45	8,7	12	10,3	21,2	3	.0276	●	●	●	
10 x 1,25	80	20,7	45	8,4	12	10,3	21,5	3	.0277	●	●	●	
12 x 1	90	24,5	45	10,6	14	12,3	25,3	4	.0301	●	●	●	
12 x 1,25	90	24,4	45	10,4	14	12,3	25,2	4	.0302	●	●	●	
12 x 1,5	90	24,8	45	10,1	14	12,3	25,7	4	.0303	●	●	●	
14 x 1,5	100	29,3	48	12,1	16	14,3	30,2	4	.0331	●	●	●	
16 x 1,5	102	32,3	48	14	18	16,3	33,3	4	.0359	●	●	●	

Andere Abmessungen auf Anfrage
Other sizes upon request

Product Finder

v_c / f_z

M

MF

UNC
UN, UNS

UNF
UNEF

G, Rp

NPT, NPTF
Rc, W

BSW, BSF

Pg

EG (STI)
SELF-LOCK

Tr

Zubehör
Accessories

Tech. Info

BGF

ZBGF

GSF

GF

GF-KEG

ZGF

ZIRK-GF

Gigant

MoSys

- Product Finder
- v_c / f_z
- M
- MF**
- UNC
UN, UNS
- UNF
UNEF
- G, Rp
- NPT, NPTF
Rc, W
- BSW, BSF
- Pg
- EG (STI)
SELF-LOCK
- Tr
- Zubehör
Accessories
- Tech. Info
- BGF
- ZBGF
- GSF**
- GF
- GF-KEG
- ZGF
- ZIRK-GF
- Gigant
- MoSys

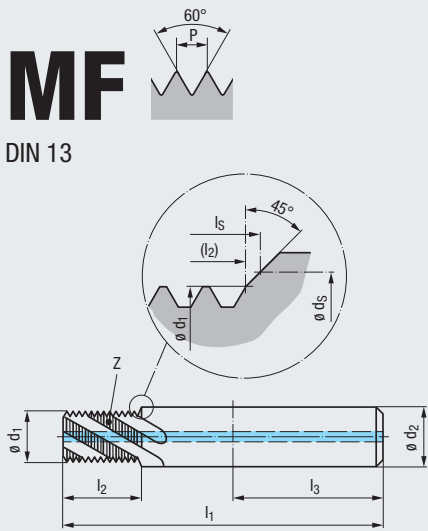

VHM

R15 **RH + LH**

Z4 - Z5 **DIN 6535**
 HB
 HE
 HA

90° **$\varnothing D$**

Mit höherer Nutenzahl
With increased number of flutes

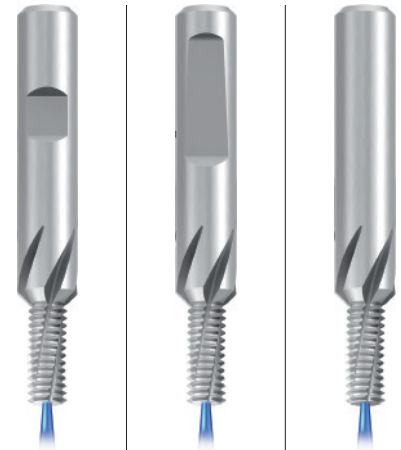

Einsatzgebiete – Material Applications – material 328

P 1.1-5.1	K 1.1-4.2	N 1.1-5, 2.1-6
N 3.1-2	N 4.1-2, 5.2	S 1.1-3

Gewindetiefe Thread depth

2 x D

Werkzeug-Ident · Tool ident

	GF335121	GF335421	GF335721
GSF-Z-VHM 2xD R15-1KZ-HB	●	●	●
GSF-Z-VHM 2xD R15-1KZ-HE	●	●	●
GSF-Z-VHM 2xD R15-1KZ-HA	●	●	●

	$\varnothing D$ mm	P mm	l_1	l_2	l_3	$\varnothing d_1$	$\varnothing d_2$	$\varnothing d_s$	l_s	Z	Dimens.- Ident
	10 x 1	80	20,5	45	8,7	12	10,3	21,2	5	.0276	
	12 x 1,25	90	24,4	45	10,4	14	12,3	25,2	5	.0302	

Andere Abmessungen auf Anfrage
Other sizes upon request

MF

DIN 13

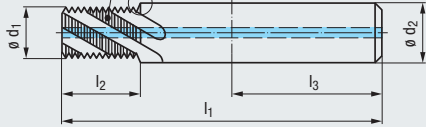
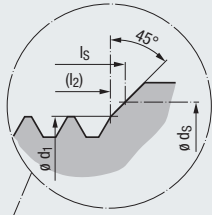

VHM	TICN
R15	RH + LH
Z4 - Z5	DIN 6535 HB HE HA
90°	Ø D

Mit höherer Nutenzahl
With increased number of flutes

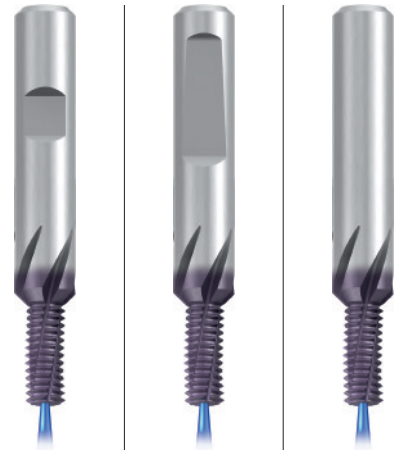

Einsatzgebiete – Material
Applications – material ▶ 328

P 1.1-5.1	M 1.1-4.1	K 1.1-4.2
N 1.1-5.2	S 1.1-2.6	H 1.1-2

Gewindetiefe
Thread depth

2 x D

Werkzeug-Ident · Tool ident

											Dimens.-Ident	GF335126	GF335426	GF335726
Ø D	P	l ₁	l ₂	l ₃	Ø d ₁	Ø d ₂	Ø d _S	l _S	Z		GSF-Z-VHM 2xD R15-IKZ-HB TICN	GSF-Z-VHM 2xD R15-IKZ-HE TICN	GSF-Z-VHM 2xD R15-IKZ-HA TICN	
M 8	x 1	74	16,5	40	6,7	10	8,3	17,2	4	.0251	●	●	●	
10	x 1	80	20,5	45	8,7	12	10,3	21,2	5	.0276	●	●	●	
12	x 1,25	90	24,4	45	10,4	14	12,3	25,2	5	.0302	●	●	●	

Andere Abmessungen auf Anfrage
Other sizes upon request

Product Finder

v_c / f_z

M

MF

UNC
UN, UNS

UNF
UNEF

G, Rp

NPT, NPTF
Rc, W

BSW, BSF

Pg

EG (STI)
SELF-LOCK

Tr

Zubehör
Accessories

Tech. Info

BGF

ZBGF

GSF

GF

GF-KEG

ZGF

ZIRK-GF

Gigant

MoSys



Product Finder

v_c / f_z

M

MF

UNC
UN, UNS

UNF
UNEF

G, Rp

NPT, NPTF
Rc, W

BSW, BSF

Pg

EG (STI)
SELF-LOCK

Tr

Zubehör
Accessories

Tech. Info

BGF

ZBGF

GSF

GF

GF-KEG

ZGF

ZIRK-GF

Gigant

MoSys



UNC

ASME B.1.1

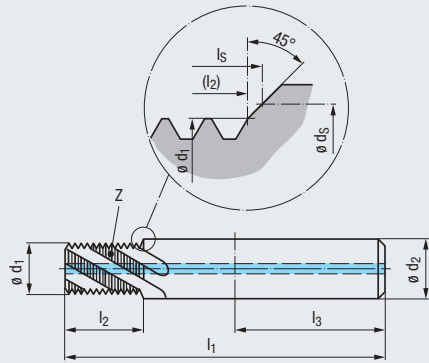

VHM

R30

RH + LH

Z3 - Z5



DIN 6535

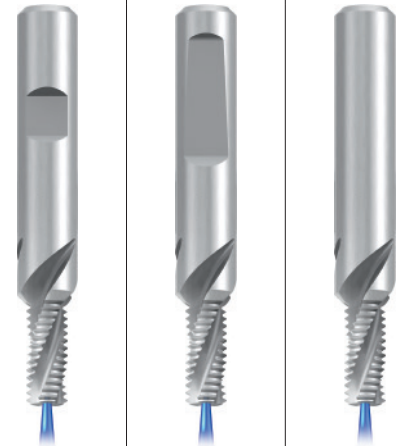

Einsatzgebiete – Material
Applications – material

» 328

P 1.1-3.1 K 1.1-4.2 N 1.1-5
N 2.1-6 N 3.1-4.2, 5.2 S 1.1-2

Gewindetiefe
Thread depth

1,5 x D

Werkzeug-Ident · Tool ident

GF322101 GF322401 GF322701

ø D inch	P Gg/1" (tpi)	l ₁	l ₂	l ₃	ø d ₁	ø d ₂	ø d _s	l _s	Z	Dimens.- Ident
Nr. 12	24	62	9	36	4,15	8	5,79	9,7	3	.5008
1/4	20	62	10,8	36	4,7	8	6,65	11,7	3	.5009
5/16	18	74	13,4	40	6,15	10	8,25	14,4	3	.5010
3/8	16	80	15,1	45	7,65	12	9,83	16,1	3	.5011
7/16	14	80	17,3	45	9	12	11,43	18,3	3	.5012
1/2	13	90	20,6	45	10,35	14	13	21,7	4	.5013
9/16	12	100	22,3	48	11,8	16	14,61	23,5	4	.5014
5/8	11	102	24,3	48	13,1	18	16,18	25,6	4	.5015
3/4	10	110	29,3	50	16	20	19,35	30,7	5	.5016

GSF-VHM 1,5xD R30-IKZ-HB	GSF-VHM 1,5xD R30-IKZ-HE	GSF-VHM 1,5xD R30-IKZ-HA
•	•	•
•	•	•
•	•	•
•	•	•
•	•	•
•	•	•
•	•	•
•	•	•
•	•	•
•	•	•

Gewindetiefe
Thread depth

2 x D

Werkzeug-Ident · Tool ident

GF332101 GF332401 GF332701

ø D inch	P Gg/1" (tpi)	l ₁	l ₂	l ₃	ø d ₁	ø d ₂	ø d _s	l _s	Z	Dimens.- Ident
Nr. 12	24	62	11,1	36	4,15	8	5,79	11,9	3	.5008
1/4	20	62	13,3	36	4,7	8	6,65	14,2	3	.5009
5/16	18	74	16,2	40	6,15	10	8,25	17,2	3	.5010
3/8	16	80	19,9	45	7,65	12	9,83	20,8	3	.5011
7/16	14	80	22,7	45	9	12	11,43	23,8	3	.5012
1/2	13	90	26,4	45	10,35	14	13	27,6	4	.5013
9/16	12	100	30,7	48	11,8	16	14,61	32	4	.5014
5/8	11	102	33,5	48	13,1	18	16,18	34,9	4	.5015
3/4	10	110	39,4	50	16	20	19,35	40,9	5	.5016

GSF-VHM 2xD R30-IKZ-HB	GSF-VHM 2xD R30-IKZ-HE	GSF-VHM 2xD R30-IKZ-HA
•	•	•
•	•	•
•	•	•
•	•	•
•	•	•
•	•	•
•	•	•
•	•	•
•	•	•
•	•	•

Gewindetiefe
Thread depth

2,5 x D

Werkzeug-Ident · Tool ident

GF342101 GF342401 GF342701

ø D inch	P Gg/1" (tpi)	l ₁	l ₂	l ₃	ø d ₁	ø d ₂	ø d _s	l _s	Z	Dimens.- Ident
3/8	16	85	24,6	45	7,65	12	9,83	25,6	3	.5011
7/16	14	85	28,2	45	9	12	11,43	29,2	3	.5012
1/2	13	96	32,3	45	10,35	14	13	33,4	4	.5013
9/16	12	107	37,1	48	11,8	16	14,61	38,3	4	.5014
5/8	11	110	40,5	48	13,1	18	16,18	41,8	4	.5015
3/4	10	125	49,6	50	16	20	19,35	51,1	5	.5016

GSF-VHM 2,5xD R30-IKZ-HB	GSF-VHM 2,5xD R30-IKZ-HE	GSF-VHM 2,5xD R30-IKZ-HA
•	•	•
•	•	•
•	•	•
•	•	•
•	•	•
•	•	•

Andere Abmessungen auf Anfrage
Other sizes upon request

UNC

ASME B.1.1

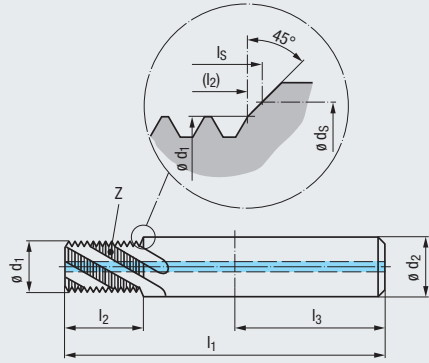

VHM	TICN
R30	RH + LH
Z3 - Z5	DIN 6535 HB HE HA
90°	θD

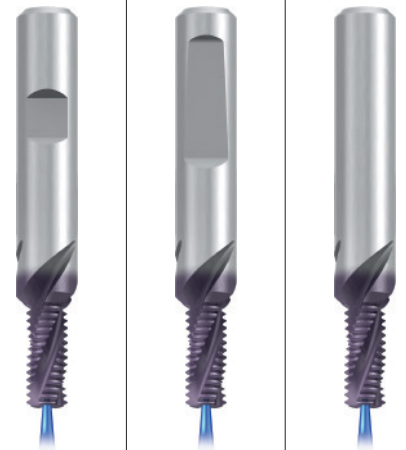

Einsatzgebiete – Material Applications – material **328**

P 1.1-3.1	M 1.1-2.1	K 1.1-4.2
N 1.1-2.7	N 3.1-5.2	S 1.1-2,2.1

Gewindetiefe Thread depth

1,5 x D

Werkzeug-Ident · Tool ident

θD inch	P Gg/1" (tpi)	l_1	l_2	l_3	θd_1	θd_2	θd_3	l_s	Z	Dimens.-Ident	GF322106	GF322406	GF322706
											GSF-VHM 1,5xD R30-IKZ-HB TICN	GSF-VHM 1,5xD R30-IKZ-HE TICN	GSF-VHM 1,5xD R30-IKZ-HA TICN
Nr. 12	24	62	9	36	4,15	8	5,79	9,7	3	.5008			
1/4	20	62	10,8	36	4,7	8	6,65	11,7	3	.5009	●	●	●
5/16	18	74	13,4	40	6,15	10	8,25	14,4	3	.5010	●	●	●
3/8	16	80	15,1	45	7,65	12	9,83	16,1	3	.5011	●	●	●
7/16	14	80	17,3	45	9	12	11,43	18,3	3	.5012	●	●	●
1/2	13	90	20,6	45	10,35	14	13	21,7	4	.5013	●	●	●
9/16	12	100	22,3	48	11,8	16	14,61	23,5	4	.5014	●	●	●
5/8	11	102	24,3	48	13,1	18	16,18	25,6	4	.5015	●	●	●
3/4	10	110	29,3	50	16	20	19,35	30,7	5	.5016	●	●	●

Gewindetiefe Thread depth

2 x D

Werkzeug-Ident · Tool ident

θD inch	P Gg/1" (tpi)	l_1	l_2	l_3	θd_1	θd_2	θd_3	l_s	Z	Dimens.-Ident	GF332106	GF332406	GF332706
											GSF-VHM 2xD R30-IKZ-HB TICN	GSF-VHM 2xD R30-IKZ-HE TICN	GSF-VHM 2xD R30-IKZ-HA TICN
Nr. 12	24	62	11,1	36	4,15	8	5,79	11,9	3	.5008			
1/4	20	62	13,3	36	4,7	8	6,65	14,2	3	.5009	●	●	●
5/16	18	74	16,2	40	6,15	10	8,25	17,2	3	.5010	●	●	●
3/8	16	80	19,9	45	7,65	12	9,83	20,8	3	.5011	●	●	●
7/16	14	80	22,7	45	9	12	11,43	23,8	3	.5012	●	●	●
1/2	13	90	26,4	45	10,35	14	13	27,6	4	.5013	●	●	●
9/16	12	100	30,7	48	11,8	16	14,61	32	4	.5014	●	●	●
5/8	11	102	33,5	48	13,1	18	16,18	34,9	4	.5015	●	●	●
3/4	10	110	39,4	50	16	20	19,35	40,9	5	.5016	●	●	●

Gewindetiefe Thread depth

2,5 x D

Werkzeug-Ident · Tool ident

θD mm	P Gg/1" (tpi)	l_1	l_2	l_3	θd_1	θd_2	θd_3	l_s	Z	Dimens.-Ident	GF342106	GF342406	GF342706
											GSF-VHM 2,5xD R30-IKZ-HB TICN	GSF-VHM 2,5xD R30-IKZ-HE TICN	GSF-VHM 2,5xD R30-IKZ-HA TICN
3/8	16	85	24,6	45	7,65	12	9,83	25,6	3	.5011	●	●	●
7/16	14	85	28,2	45	9	12	11,43	29,2	3	.5012	●	●	●
1/2	13	96	32,3	45	10,35	14	13	33,4	4	.5013	●	●	●
9/16	12	107	37,1	48	11,8	16	14,61	38,3	4	.5014	●	●	●
5/8	11	110	40,5	48	13,1	18	16,18	41,8	4	.5015	●	●	●
3/4	10	125	49,6	50	16	20	19,35	51,1	5	.5016	●	●	●

Andere Abmessungen auf Anfrage
Other sizes upon request

Product Finder

v_c / f_z

M

MF

UNC
UN, UNS

UNF
UNEF

G, Rp

NPT, NPTF
Rc, W

BSW, BSF

Pg

EG (STI)
SELF-LOCK

Tr

Zubehör
Accessories

Tech. Info

BGF

ZBGF

GSF

GF

GF-KEG

ZGF

ZIRK-GF

Gigant

MoSys

- Product Finder
- v_c / f_z
- M
- MF
- UNC
UN, UNS
- UNF
UNEF
- G, Rp
- NPT, NPTF
Rc, W
- BSW, BSF
- Pg
- EG (STI)
SELF-LOCK
- Tr
- Zubehör
Accessories
- Tech. Info
- BGF
- ZBGF
- GSF
- GF
- GF-KEG
- ZGF
- ZIRK-GF
- Gigant
- MoSys

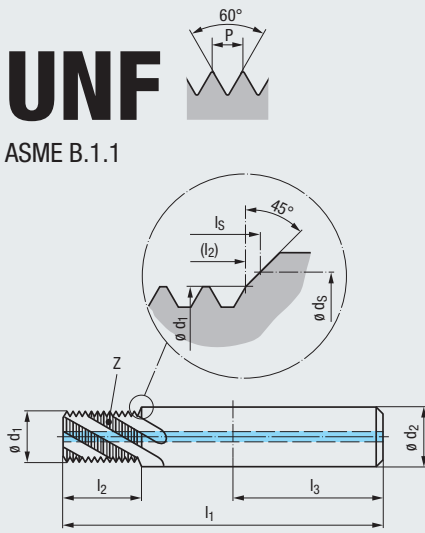

ASME B.1.1

VHM

R30 **RH + LH**

Z3 - Z5 **DIN 6535**
 HB
 HE
 HA

90° **Ø D**

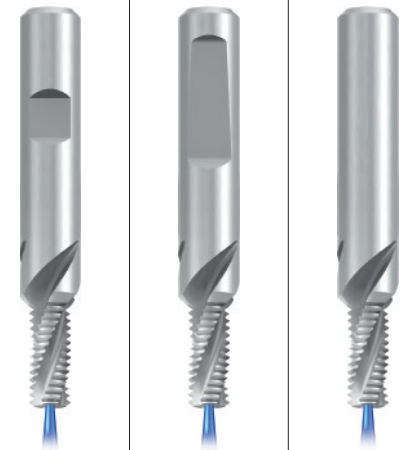

Einsatzgebiete – Material
Applications – material

» 328

P 1.1-3.1 **K** 1.1-4.2 **N** 1.1-5
N 2.1-6 **N** 3.1-4.2, 5.2 **S** 1.1-2

Gewindetiefe
Thread depth

1,5 x D

Werkzeug-Ident · Tool ident

	GF322101	GF322401	GF322701
	GSF-VHM 1,5xD R30-IKZ-HB	GSF-VHM 1,5xD R30-IKZ-HE	GSF-VHM 1,5xD R30-IKZ-HA
•	•	•	•
•	•	•	•
•	•	•	•
•	•	•	•
•	•	•	•
•	•	•	•
•	•	•	•
•	•	•	•
•	•	•	•
•	•	•	•

Ø D inch	P Gg/1" (tpi)	l ₁	l ₂	l ₃	Ø d ₁	Ø d ₂	Ø d _s	l _s	Z	Dimens.- Ident
Nr. 10	32	55	7,6	36	3,8	6	5,13	8,1	3	.5041
Nr. 12	28	62	8,6	36	4,3	8	5,79	9,3	3	.5042
1/4	28	62	10,5	36	5,15	8	6,65	11,1	3	.5043
5/16	24	74	12,2	40	6,6	10	8,25	12,9	3	.5044
3/8	24	80	14,3	45	8,2	12	9,83	15	3	.5045
7/16	20	80	17,2	45	9,55	12	11,43	18	3	.5046
1/2	20	90	19,7	45	11,1	14	13	20,5	4	.5047
9/16	18	100	21,9	48	12,5	16	14,61	22,8	4	.5048
5/8	18	102	24,8	48	14,1	18	16,18	25,6	4	.5049
3/4	16	110	29,5	50	17	20	19,35	30,4	5	.5050

Gewindetiefe
Thread depth

2 x D

Werkzeug-Ident · Tool ident

	GF332101	GF332401	GF332701
	GSF-VHM 2xD R30-IKZ-HB	GSF-VHM 2xD R30-IKZ-HE	GSF-VHM 2xD R30-IKZ-HA
•	•	•	•
•	•	•	•
•	•	•	•
•	•	•	•
•	•	•	•
•	•	•	•
•	•	•	•
•	•	•	•
•	•	•	•
•	•	•	•

Ø D inch	P Gg/1" (tpi)	l ₁	l ₂	l ₃	Ø d ₁	Ø d ₂	Ø d _s	l _s	Z	Dimens.- Ident
Nr. 10	32	55	9,9	36	3,8	6	5,13	10,5	3	.5041
Nr. 12	28	62	11,4	36	4,3	8	5,79	12	3	.5042
1/4	28	62	13,2	36	5,15	8	6,65	13,8	3	.5043
5/16	24	74	16,4	40	6,6	10	8,25	17,1	3	.5044
3/8	24	80	19,6	45	8,2	12	9,83	20,3	3	.5045
7/16	20	80	22,3	45	9,55	12	11,43	23,1	3	.5046
1/2	20	90	26,1	45	11,1	14	13	26,9	4	.5047
9/16	18	100	29	48	12,5	16	14,61	29,9	4	.5048
5/8	18	102	33,2	48	14,1	18	16,18	34,1	4	.5049
3/4	16	110	39	50	17	20	19,35	40	5	.5050

Andere Abmessungen auf Anfrage
Other sizes upon request

UNF

ASME B.1.1

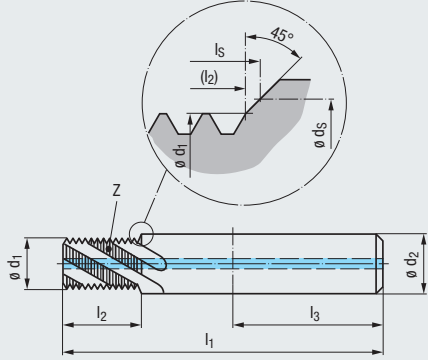
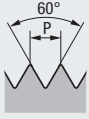

VHM	TICN
R30	RH + LH
Z3 - Z5	DIN 6535 HB HE HA
90°	Ø D

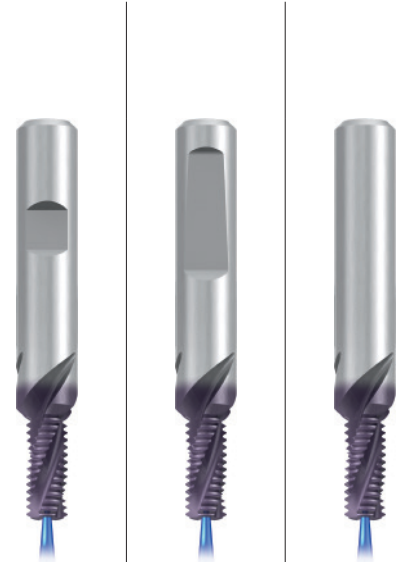

- Product Finder
- vc / fz
- M
- MF
- UNC UN, UNS
- UNF** UNEF
- G, Rp
- NPT, NPTF Rc, W
- BSW, BSF
- Pg
- EG (STI) SELF-LOCK
- Tr
- Zubehör Accessories
- Tech. Info
- BGF
- ZBGF
- GSF**
- GF
- GF-KEG
- ZGF
- ZIRK-GF
- Gigant
- MoSys

Einsatzgebiete – Material Applications – material ▶▶ 328

P 1.1-3.1 M 1.1-2.1 K 1.1-4.2
 N 1.1-2.7 N 3.1-5.2 S 1.1-2,2.1

Gewindetiefe Thread depth

1,5 x D

Werkzeug-Ident · Tool ident											GF322106	GF322406	GF322706
Ø D inch	P Gg/1" (tpi)	l ₁	l ₂	l ₃	Ø d ₁	Ø d ₂	Ø d _S	l _S	Z	Dimens.-Ident	GSF-VHM 1,5xD R30-1KZ-HB TICN	GSF-VHM 1,5xD R30-1KZ-HE TICN	GSF-VHM 1,5xD R30-1KZ-HA TICN
Nr. 10	32	55	7,6	36	3,8	6	5,13	8,1	3	.5041	●	●	●
Nr. 12	28	62	8,6	36	4,3	8	5,79	9,3	3	.5042	●	●	●
1/4	28	62	10,5	36	5,15	8	6,65	11,1	3	.5043	●	●	●
5/16	24	74	12,2	40	6,6	10	8,25	12,9	3	.5044	●	●	●
3/8	24	80	14,3	45	8,2	12	9,83	15	3	.5045	●	●	●
7/16	20	80	17,2	45	9,55	12	11,43	18	3	.5046	●	●	●
1/2	20	90	19,7	45	11,1	14	13	20,5	4	.5047	●	●	●
9/16	18	100	21,9	48	12,5	16	14,61	22,8	4	.5048	●	●	●
5/8	18	102	24,8	48	14,1	18	16,18	25,6	4	.5049	●	●	●
3/4	16	110	29,5	50	17	20	19,35	30,4	5	.5050	●	●	●

Gewindetiefe Thread depth

2 x D

Werkzeug-Ident · Tool ident											GF332106	GF332406	GF332706
Ø D inch	P Gg/1" (tpi)	l ₁	l ₂	l ₃	Ø d ₁	Ø d ₂	Ø d _S	l _S	Z	Dimens.-Ident	GSF-VHM 2xD R30-1KZ-HB TICN	GSF-VHM 2xD R30-1KZ-HE TICN	GSF-VHM 2xD R30-1KZ-HA TICN
Nr. 10	32	55	9,9	36	3,8	6	5,13	10,5	3	.5041	●	●	●
Nr. 12	28	62	11,4	36	4,3	8	5,79	12	3	.5042	●	●	●
1/4	28	62	13,2	36	5,15	8	6,65	13,8	3	.5043	●	●	●
5/16	24	74	16,4	40	6,6	10	8,25	17,1	3	.5044	●	●	●
3/8	24	80	19,6	45	8,2	12	9,83	20,3	3	.5045	●	●	●
7/16	20	80	22,3	45	9,55	12	11,43	23,1	3	.5046	●	●	●
1/2	20	90	26,1	45	11,1	14	13	26,9	4	.5047	●	●	●
9/16	18	100	29	48	12,5	16	14,61	29,9	4	.5048	●	●	●
5/8	18	102	33,2	48	14,1	18	16,18	34,1	4	.5049	●	●	●
3/4	16	110	39	50	17	20	19,35	40	5	.5050	●	●	●

Andere Abmessungen auf Anfrage
 Other sizes upon request

- EG (STI) SELF-LOCK
- Tr
- Zubehör Accessories
- Tech. Info
- BGF
- ZBGF
- GSF**
- GF
- GF-KEG
- ZGF
- ZIRK-GF
- Gigant
- MoSys



- Product Finder
- v_c / f_z
- M
- MF
- UNC UN, UNS
- UNF UNEF
- G Rp
- NPT, NPTF Rc, W
- BSW, BSF
- Pg
- EG (STI) SELF-LOCK
- Tr
- Zubehör Accessories
- Tech. Info
- BGF
- ZBGF
- GSF
- GF
- GF-KEG
- ZGF
- ZIRK-GF
- Gigant
- MoSys

G (BSP)

DIN EN ISO 228

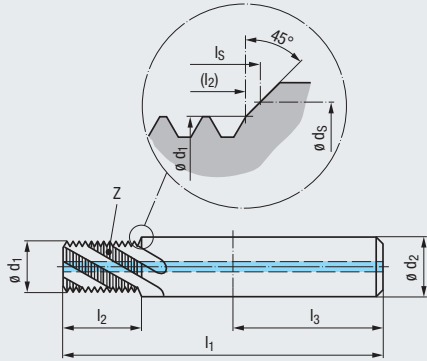

VHM

R30

RH + LH

Z3 - Z4



DIN 6535

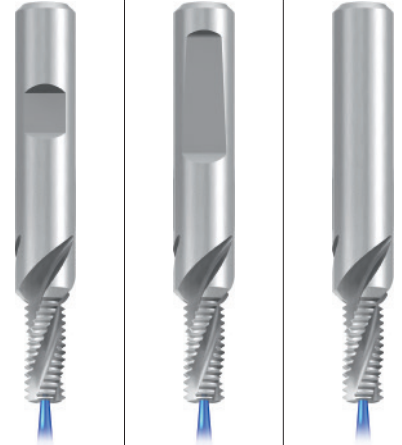

Einsatzgebiete – Material Applications – material » 328

P 1.1-3.1 K 1.1-4.2 N 1.1-5
N 2.1-6 N 3.1-4.2, 5.2 S 1.1-2

Gewindetiefe Thread depth

1,5 x D

Werkzeug-Ident · Tool ident

GF322101 GF322401 GF322701

Nenngröße Nom. size

Dimens.-Ident

GSF-VHM 1,5xD R30-IKZ-HB GSF-VHM 1,5xD R30-IKZ-HE GSF-VHM 1,5xD R30-IKZ-HA

$\varnothing D$	P Gg/1" (tpi)	l_1	l_2	l_3	$\varnothing d_1$	$\varnothing d_2$	$\varnothing d_s$	l_s	Z	Dimens.-Ident	GF322101	GF322401	GF322701
G 1/8	28	80	15	45	8,2	12	10	15,7	3	.4035	•	•	•
1/4	19	100	20,7	48	11	16	13,5	21,8	4	.4036	•	•	•
3/8	19	102	26,1	48	14,5	18	17	27,2	4	.4037	•	•	•

Gewindetiefe Thread depth

2 x D

Werkzeug-Ident · Tool ident

GF332101 GF332401 GF332701

Nenngröße Nom. size

Dimens.-Ident

GSF-VHM 2xD R30-IKZ-HB GSF-VHM 2xD R30-IKZ-HE GSF-VHM 2xD R30-IKZ-HA

$\varnothing D$	P Gg/1" (tpi)	l_1	l_2	l_3	$\varnothing d_1$	$\varnothing d_2$	$\varnothing d_s$	l_s	Z	Dimens.-Ident	GF332101	GF332401	GF332701
G 1/8	28	80	20,4	45	8,2	12	10	21,2	3	.4035	•	•	•
1/4	19	100	27,4	48	11	16	13,5	28,5	4	.4036	•	•	•
3/8	19	102	34,1	48	14,5	18	17	35,2	4	.4037	•	•	•

Andere Abmessungen auf Anfrage
Other sizes upon request

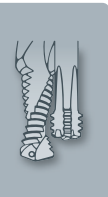

G (BSP)

DIN EN ISO 228

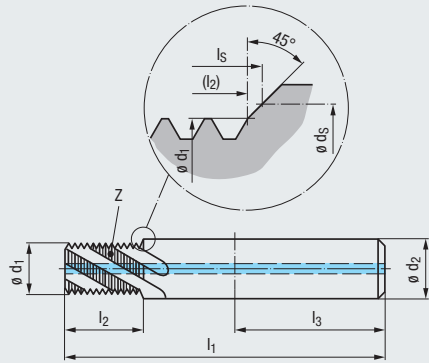

VHM	TICN
R30	RH + LH
Z3 - Z4	DIN 6535 HB HE HA
90°	Ø D

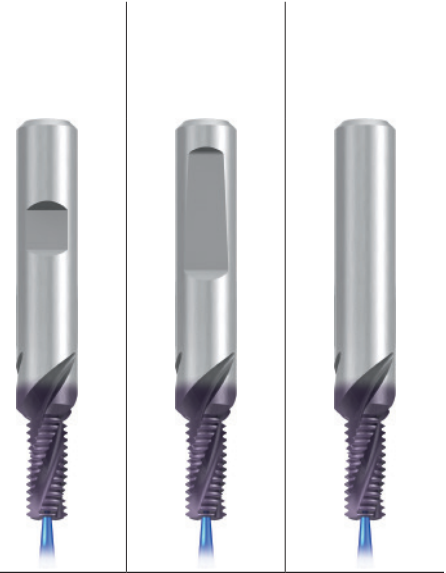

- Product Finder
- v_c / f_z
- M
- MF
- UNC
UN, UNS
- UNF
UNEF
- G, Rp**
- NPT, NPTF
Rc, W
- BSW, BSF
- Pg
- EG (STI)
SELF-LOCK

Einsatzgebiete – Material Applications – material ▶▶ 328

P 1.1-3.1	M 1.1-2.1	K 1.1-4.2
N 1.1-2.7	N 3.1-5.2	S 1.1-2, 2.1

Gewindetiefe Thread depth

1,5 x D

Werkzeug-Ident · Tool ident											GF322106	GF322406	GF322706
Nenngröße Nom. size										Dimens.-Ident	GSF-VHM 1,5xD R30-1KZ-HB TICN	GSF-VHM 1,5xD R30-1KZ-HE TICN	GSF-VHM 1,5xD R30-1KZ-HA TICN
Ø D	P Gg/1" (tpi)	l ₁	l ₂	l ₃	Ø d ₁	Ø d ₂	Ø d _s	l _s	Z		•	•	•
G 1/8	28	80	15	45	8,2	12	10	15,7	3	.4035	•	•	•
1/4	19	100	20,7	48	11	16	13,5	21,8	4	.4036	•	•	•
3/8	19	102	26,1	48	14,5	18	17	27,2	4	.4037	•	•	•

Gewindetiefe Thread depth

2 x D

Werkzeug-Ident · Tool ident											GF332106	GF332406	GF332706
Nenngröße Nom. size										Dimens.-Ident	GSF-VHM 2xD R30-1KZ-HB TICN	GSF-VHM 2xD R30-1KZ-HE TICN	GSF-VHM 2xD R30-1KZ-HA TICN
Ø D	P Gg/1" (tpi)	l ₁	l ₂	l ₃	Ø d ₁	Ø d ₂	Ø d _s	l _s	Z		•	•	•
G 1/8	28	80	20,4	45	8,2	12	10	21,2	3	.4035	•	•	•
1/4	19	100	27,4	48	11	16	13,5	28,5	4	.4036	•	•	•
3/8	19	102	34,1	48	14,5	18	17	35,2	4	.4037	•	•	•

Andere Abmessungen auf Anfrage Other sizes upon request

- Zubehör Accessories
- Tech. Info
- BGF
- ZBGF
- GSF**
- GF
- GF-KEG
- ZGF
- ZIRK-GF
- Gigant
- MoSys



● = Lagerwerkzeug, siehe Preisliste · Stock tool, see price list
○ = Kurzfristig lieferbar, Preis auf Anfrage · Available on short notice, price upon inquiry

- Product Finder
- v_c / f_z
- M
- MF
- UNC UN, UNS
- UNF UNEF
- G, Rp
- NPT, NPTF Rc, W
- BSW, BSF
- Pg
- EG (ST) SELF-LOCK
- Tr
- Zubehör Accessories
- Tech. Info
- BGF
- ZBGF
- GSF**
- GF
- GF-KEG
- ZGF
- ZIRK-GF
- Gigant
- MoSys

LK-M

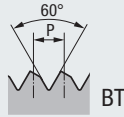

EMUGE-Norm · EMUGE Standard

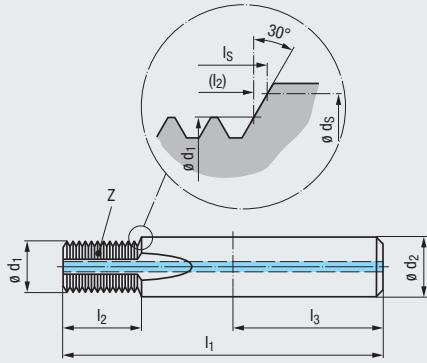

VHM

RH + LH

Z3 - Z4



DIN 6535



120°



$\varnothing D$

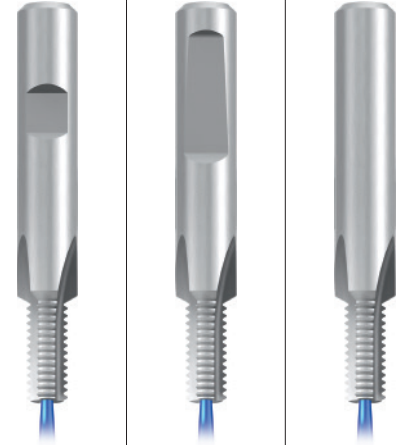

Einsatzgebiete – Material
Applications – material

» 328

P 1.1-5.1 K 1.1-4.2 N 1.1-5, 2.1-6
N 3.1-2 N 4.1-2, 5.2 S 1.1-3

Gewindetiefe
Thread depth

2 x D

Werkzeug-Ident · Tool ident

GF333101 GF333401 GF333701

	$\varnothing D$ mm	P mm	l_1	l_2	l_3	$\varnothing d_1$	$\varnothing d_2$	$\varnothing d_s$	l_s	Z	Dimens.- Ident	GF333101	GF333401	GF333701
												GSF-VHM 2xD IKZ-HB	GSF-VHM 2xD IKZ-HE	GSF-VHM 2xD IKZ-HA
LK-M	5	0,8	55	10,7	36	4	6	5,3	11,1	3	.1050	●	●	●
	6	1	62	12,4	36	4,8	8	6,3	12,8	3	.1052	●	●	●
	8	1,25	74	16,7	40	6,5	10	8,3	17,3	3	.1054	●	●	●
	10	1,5	80	20,1	45	8,2	12	10,3	20,7	3	.1056	●	●	●
	12	1,75	90	25,2	45	9,9	14	12,3	25,9	4	.1058	●	●	●

Andere Abmessungen auf Anfrage
Other sizes upon request





Gewindebohrer für Metrisches SELF-LOCK-Gewinde
siehe Seite 228 - 231

Taps for Metric SELF-LOCK thread,
see page 228 - 231

LK-M

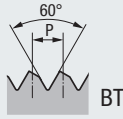

EMUGE-Norm · EMUGE Standard

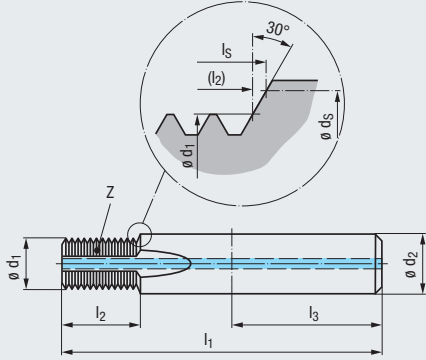

VHM	TICN
	RH + LH
Z3 - Z4	DIN 6535
	HB
	HE
	HA
120°	θD

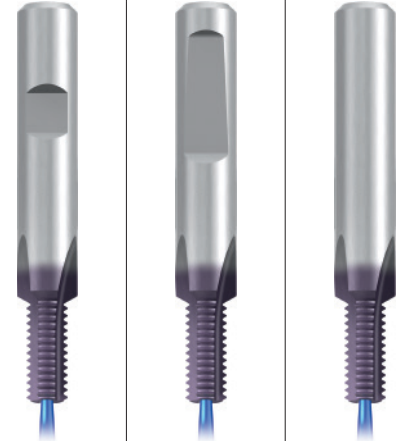

Einsatzgebiete – Material Applications – material 328

P 1.1-5.1	M 1.1-4.1	K 1.1-4.2
N 1.1-5.2	S 1.1-2.6	H 1.1-2

Gewindetiefe Thread depth

2 x D

Werkzeug-Ident · Tool ident

	GF333106	GF333406	GF333706
GSF-VHM 2xD IKZ-HB TICN	●	●	●
GSF-VHM 2xD IKZ-HE TICN	●	●	●
GSF-VHM 2xD IKZ-HA TICN	●	●	●

	θD mm	P mm	Dimens.-Ident			θd_1	θd_2	θd_s	l_s	Z
			l_1	l_2	l_3					
LK-M	5	0,8	55	10,7	36	4	6	5,3	11,1	3
	6	1	62	12,4	36	4,8	8	6,3	12,8	3
	8	1,25	74	16,7	40	6,5	10	8,3	17,3	3
	10	1,5	80	20,1	45	8,2	12	10,3	20,7	3
	12	1,75	90	25,2	45	9,9	14	12,3	25,9	4

Andere Abmessungen auf Anfrage
Other sizes upon request

Product Finder

v_c / f_z

M

MF

UNC UN, UNS

UNF UNEF

G, Rp

NPT, NPTF Rc, W

BSW, BSF

Pg

EG (STI) SELF-LOCK

Tr

Zubehör Accessories

Tech. Info

BGF

ZBGF

GSF

GF

GF-KEG

ZGF

ZIRK-GF

Gigant

MoSys

Product Finder

v_c / f_z

M

MF

UNC
UN, UNS

UNF
UNEF

G, Rp

NPT, NPTF
Rc, W

BSW, BSF

Pg

EG (STI)
SELF-LOCK

Tr

Zubehör
Accessories

Tech. Info

BGF

ZBGF

GSF

GF

GF-KEG

ZGF

ZIRK-GF

Gigant

MoSys

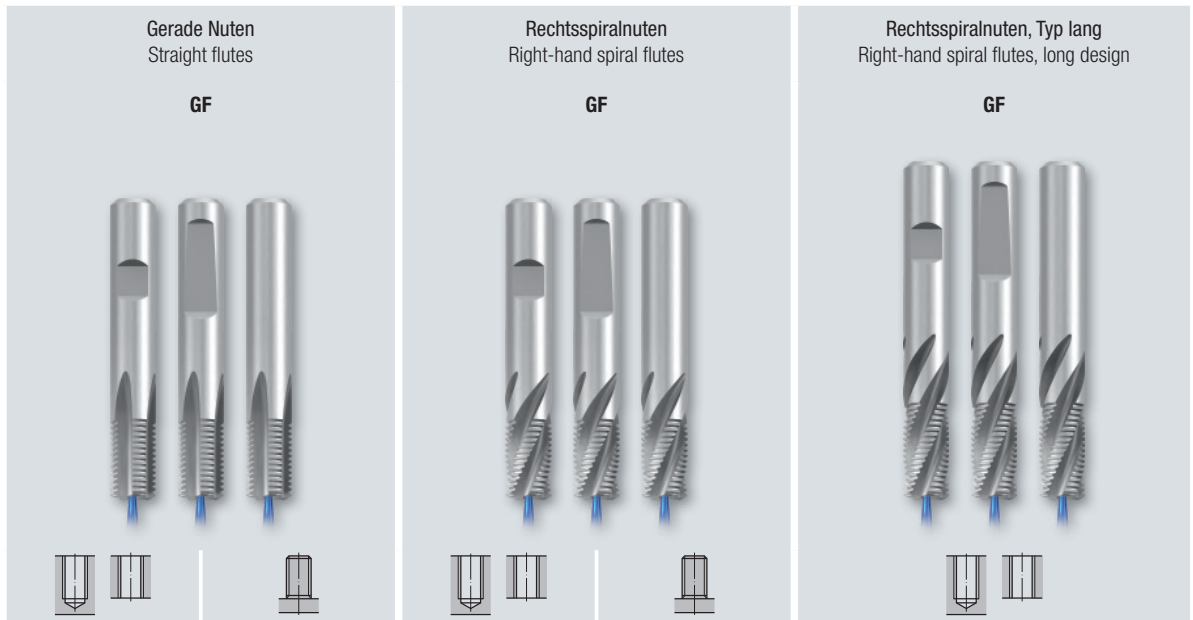

Seite · Page

M, MF	382	385	383		384
UN	390				391
G (BSP), Rp (BSPP), W	393	393	394	394	
Pg	396	396	397	397	
LK-M	398				

Mögliche Modifikationen · Possible modifications



Stirnfasen ohne/mit Stirnschnitt
Face chamfer with/without cutting face



AZR/AZ (ausgesetzte Zähne)
AZR/AZ (alternating teeth)



Unvollständigen Gang entfernen
Remove incomplete thread



IKZN (innere Kühlschmierstoff-Zufuhr mit Austritt in den Nuten)
IKZN (internal coolant supply exiting in the flutes)



Halsfreischliff
Recessed neck



Schaftkühlrillen
Coolant grooves along the shank

Eine Beschreibung dieser Modifikationsmöglichkeiten finden Sie auf Seite 456 - 457
For a description of these modifications, see pages 456 - 457

Gewindefräszyklus · Thread milling cycle

GF, GF-Z

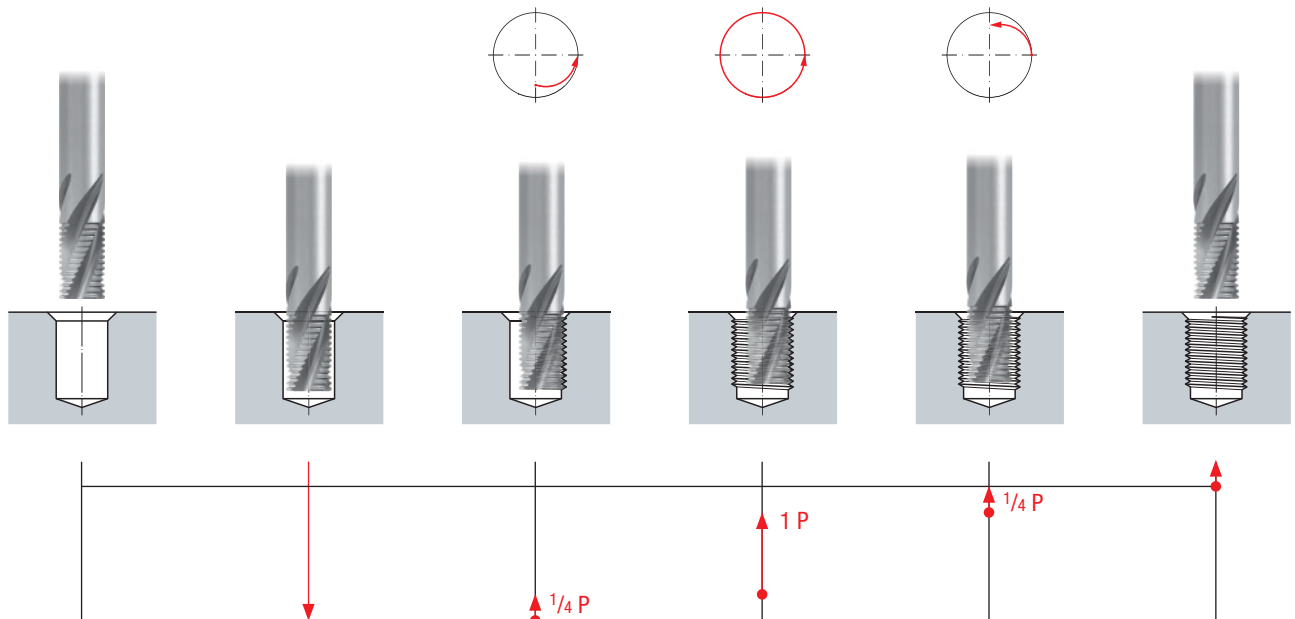

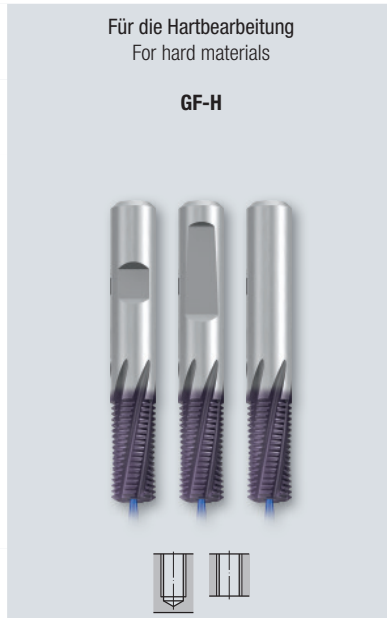
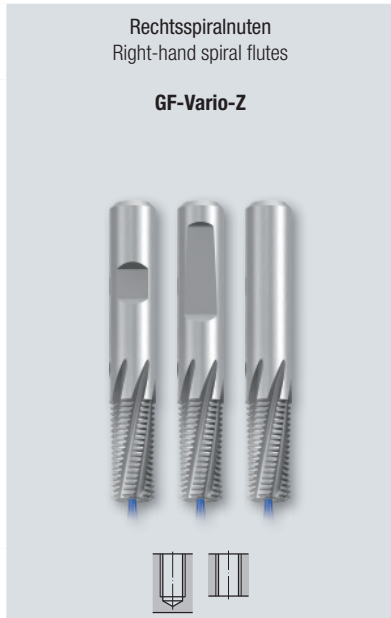

Seite · Page

386	387 - 388	389	M, MF
	392		UN
	395		G (BSP), Rp (BSPP), W
			Pg
			LK-M

Product Finder

v_c / f_z

M

MF

UNC
UN, UNS

UNF
UNEF

G, Rp

NPT, NPTF
Rc, W

BSW, BSF

Pg

EG (STI)
SELF-LOCK

Tr

Zubehör
Accessories

Tech. Info

BGF

ZBGF

GSF

GF

GF-KEG

ZGF

ZIRK-GF

Gigant

MoSys



Mögliche Modifikationen · Possible modifications



Stirnfase ohne/mit Stirnschnitt
Face chamfer with/without cutting face



AZR/AZ (ausgesetzte Zähne)
AZR/AZ (alternating teeth)



Unvollständigen Gang entfernen
Remove incomplete thread



IKZN (innere Kühlschmierstoff-Zufuhr mit Austritt in den Nuten)
IKZN (internal coolant supply exiting in the flutes)



Halsfreischliff
Recessed neck



Schaftkühlfluten
Coolant grooves along the shank

Eine Beschreibung dieser Modifikationsmöglichkeiten finden Sie auf Seite 456 - 457
For a description of these modifications, see pages 456 - 457

Gewindefräszyklus · Thread milling cycle

GF-Vario-Z, GF-H

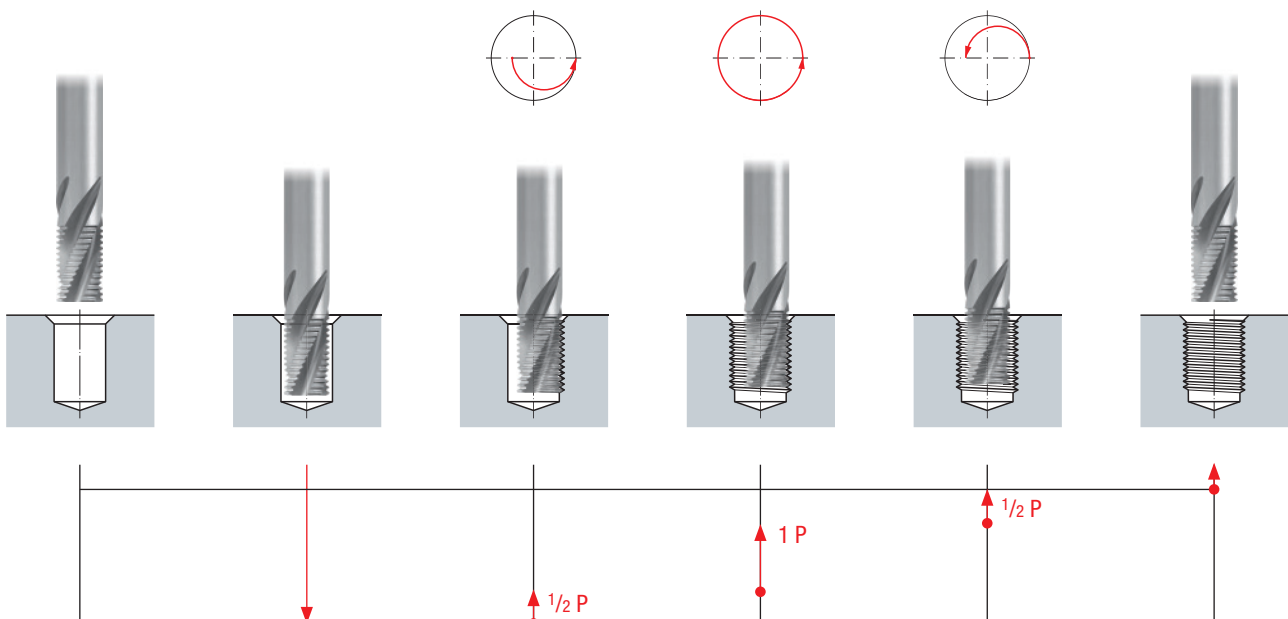

- Product Finder
- v_c / f_z
- M
- MF
- UNC UN, UNS
- UNF UNEF
- G, Rp
- NPT, NPTF Rc, W
- BSW, BSF
- Pg
- EG (STI) SELF-LOCK
- Tr
- Zubehör Accessories
- Tech. Info
- BGF
- ZBGF
- GSF
- GF
- GF-KEG
- ZGF
- ZIRK-GF
- Gigant
- MoSys

M, MF

DIN 13



Für Innengewinde
For internal threads

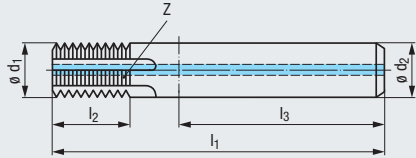

VHM

RH + LH

Z3 - Z5



DIN 6535



$\varnothing D$



Einsatzgebiete – Material
Applications – material

» 328

P 1.1-5.1 K 1.1-4.2 N 1.1-5, 2.1-6
N 3.1-2 N 4.1-2, 5.2 S 1.1-3

P mm	$\varnothing D_{min.}$ mm	$\varnothing d_1$ mm	$\varnothing d_2$	l_1	l_2	l_3	Z	GF-VHM IKZ-HB	GF-VHM IKZ-HE	GF-VHM IKZ-HA
0,5	10	7,9	8	63	12,2	36	3	GF163101.9506	● GF163401.9506	● GF163701.9506
0,5	12	9,9	10	70	16,2	40	4	GF163211.9506	● GF163511.9506	● GF163811.9506
0,75	11	7,9	8	63	12,3	36	3	GF163101.9509	● GF163401.9509	● GF163701.9509
0,75	13	9,9	10	70	16,8	40	4	GF163211.9509	● GF163511.9509	● GF163811.9509
1	14	9,9	10	70	16,4	40	4	GF163211.9512	● GF163511.9512	● GF163811.9512
1	16	11,9	12	80	20,4	45	4	GF163121.9512	● GF163421.9512	● GF163721.9512
1	22	15,9	16	90	25,4	48	5	GF163131.9512	● GF163431.9512	● GF163731.9512
1	27	19,9	20	105	32,4	50	5	GF163151.9512	● GF163451.9512	● GF163751.9512
1,5	14	9,9	10	70	17,1	40	4	GF163211.9514	● GF163511.9514	● GF163811.9514
1,5	16	11,9	12	80	21,6	45	4	GF163121.9514	● GF163421.9514	● GF163721.9514
1,5	22	15,9	16	90	26,1	48	5	GF163131.9514	● GF163431.9514	● GF163731.9514
1,5	27	19,9	20	105	33,6	50	5	GF163151.9514	● GF163451.9514	● GF163751.9514
2	18	11,9	12	80	20,9	45	4	GF163121.9516	● GF163421.9516	● GF163721.9516
2	22	15,9	16	90	26,9	48	5	GF163131.9516	● GF163431.9516	● GF163731.9516
2	27	19,9	20	105	32,9	50	5	GF163151.9516	● GF163451.9516	● GF163751.9516
3	24	15,9	16	90	28,3	48	5	GF163131.9518	● GF163431.9518	● GF163731.9518
3	30	19,9	20	105	34,3	50	5	GF163151.9518	● GF163451.9518	● GF163751.9518

TICN



Einsatzgebiete – Material
Applications – material

» 328

P 1.1-5.1 M 1.1-4.1 K 1.1-4.2
N 1.1-5.2 S 1.1-2.6 H 1.1-2

P mm	$\varnothing D_{min.}$ mm	$\varnothing d_1$ mm	$\varnothing d_2$	l_1	l_2	l_3	Z	GF-VHM IKZ-HB TICN	GF-VHM IKZ-HE TICN	GF-VHM IKZ-HA TICN
0,5	10	7,9	8	63	12,2	36	3	GF163106.9506	● GF163406.9506	● GF163706.9506
0,5	12	9,9	10	70	16,2	40	4	GF163216.9506	● GF163516.9506	● GF163816.9506
0,75	11	7,9	8	63	12,3	36	3	GF163106.9509	● GF163406.9509	● GF163706.9509
0,75	13	9,9	10	70	16,8	40	4	GF163216.9509	● GF163516.9509	● GF163816.9509
1	14	9,9	10	70	16,4	40	4	GF163216.9512	● GF163516.9512	● GF163816.9512
1	16	11,9	12	80	20,4	45	4	GF163126.9512	● GF163426.9512	● GF163726.9512
1	22	15,9	16	90	25,4	48	5	GF163136.9512	● GF163436.9512	● GF163736.9512
1	27	19,9	20	105	32,4	50	5	GF163156.9512	● GF163456.9512	● GF163756.9512
1,5	14	9,9	10	70	17,1	40	4	GF163216.9514	● GF163516.9514	● GF163816.9514
1,5	16	11,9	12	80	21,6	45	4	GF163126.9514	● GF163426.9514	● GF163726.9514
1,5	22	15,9	16	90	26,1	48	5	GF163136.9514	● GF163436.9514	● GF163736.9514
1,5	27	19,9	20	105	33,6	50	5	GF163156.9514	● GF163456.9514	● GF163756.9514
2	18	11,9	12	80	20,9	45	4	GF163126.9516	● GF163426.9516	● GF163726.9516
2	22	15,9	16	90	26,9	48	5	GF163136.9516	● GF163436.9516	● GF163736.9516
2	27	19,9	20	105	32,9	50	5	GF163156.9516	● GF163456.9516	● GF163756.9516
3	24	15,9	16	90	28,3	48	5	GF163136.9518	● GF163436.9518	● GF163736.9518
3	30	19,9	20	105	34,3	50	5	GF163156.9518	● GF163456.9518	● GF163756.9518

Andere Steigungen auf Anfrage
Tools for different thread pitch upon request

M, MF

DIN 13

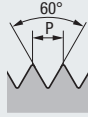

VHM

R30

RH + LH

Z3 - Z5



DIN 6535



Für Innengewinde
For internal threads

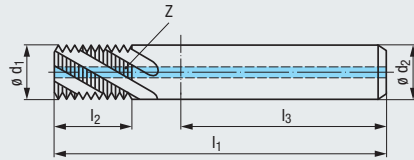

Einsatzgebiete – Material
Applications – material

» 328

P 1.1-3.1 K 1.1-4.2 N 1.1-5
N 2.1-6 N 3.1-4.2, 5.2 S 1.1-2

P mm	∅ D _{min.} mm	∅ d ₁ mm	∅ d ₂	l ₁	l ₂	l ₃	Z	GF-VHM R30-IKZ-HB	GF-VHM R30-IKZ-HE	GF-VHM R30-IKZ-HA
0,5	10	7,9	8	63	12,2	36	3	GF162101.9506 ●	GF162401.9506 ●	GF162701.9506 ●
0,75	11	7,9	8	63	12,3	36	3	GF162101.9509 ●	GF162401.9509 ●	GF162701.9509 ●
1	14	9,9	10	70	16,4	40	4	GF162211.9512 ●	GF162511.9512 ●	GF162811.9512 ●
1	16	11,9	12	80	20,4	45	4	GF162121.9512 ●	GF162421.9512 ●	GF162721.9512 ●
1	22	15,9	16	90	25,4	48	5	GF162131.9512 ●	GF162431.9512 ●	GF162731.9512 ●
1	27	19,9	20	105	32,4	50	5	GF162151.9512 ●	GF162451.9512 ●	GF162751.9512 ●
1,5	14	9,9	10	70	17,1	40	4	GF162211.9514 ●	GF162511.9514 ●	GF162811.9514 ●
1,5	16	11,9	12	80	21,6	45	4	GF162121.9514 ●	GF162421.9514 ●	GF162721.9514 ●
1,5	22	15,9	16	90	26,1	48	5	GF162131.9514 ●	GF162431.9514 ●	GF162731.9514 ●
1,5	27	19,9	20	105	33,6	50	5	GF162151.9514 ●	GF162451.9514 ●	GF162751.9514 ●
2	18	11,9	12	80	20,9	45	4	GF162121.9516 ●	GF162421.9516 ●	GF162721.9516 ●
2	22	15,9	16	90	26,9	48	5	GF162131.9516 ●	GF162431.9516 ●	GF162731.9516 ●
2	27	19,9	20	105	32,9	50	5	GF162151.9516 ●	GF162451.9516 ●	GF162751.9516 ●
3	24	15,9	16	90	28,3	48	5	GF162131.9518 ●	GF162431.9518 ●	GF162731.9518 ●
3	30	19,9	20	105	34,9	50	5	GF162151.9518 ●	GF162451.9518 ●	GF162751.9518 ●

TICN

Einsatzgebiete – Material
Applications – material

» 328

P 1.1-3.1 M 1.1-2.1 K 1.1-4.2
N 1.1-2.7 N 3.1-5.2 S 1.1-2, 2.1

P mm	∅ D _{min.} mm	∅ d ₁ mm	∅ d ₂	l ₁	l ₂	l ₃	Z	GF-VHM R30-IKZ-HB TICN	GF-VHM R30-IKZ-HE TICN	GF-VHM R30-IKZ-HA TICN
0,5	10	7,9	8	63	12,2	36	3	GF162106.9506 ●	GF162406.9506 ●	GF162706.9506 ●
0,75	11	7,9	8	63	12,3	36	3	GF162106.9509 ●	GF162406.9509 ●	GF162706.9509 ●
1	14	9,9	10	70	16,4	40	4	GF162216.9512 ●	GF162516.9512 ●	GF162816.9512 ●
1	16	11,9	12	80	20,4	45	4	GF162126.9512 ●	GF162426.9512 ●	GF162726.9512 ●
1	22	15,9	16	90	25,4	48	5	GF162136.9512 ●	GF162436.9512 ●	GF162736.9512 ●
1	27	19,9	20	105	32,4	50	5	GF162156.9512 ●	GF162456.9512 ●	GF162756.9512 ●
1,5	14	9,9	10	70	17,1	40	4	GF162216.9514 ●	GF162516.9514 ●	GF162816.9514 ●
1,5	16	11,9	12	80	21,6	45	4	GF162126.9514 ●	GF162426.9514 ●	GF162726.9514 ●
1,5	22	15,9	16	90	26,1	48	5	GF162136.9514 ●	GF162436.9514 ●	GF162736.9514 ●
1,5	27	19,9	20	105	33,6	50	5	GF162156.9514 ●	GF162456.9514 ●	GF162756.9514 ●
2	18	11,9	12	80	20,9	45	4	GF162126.9516 ●	GF162426.9516 ●	GF162726.9516 ●
2	22	15,9	16	90	26,9	48	5	GF162136.9516 ●	GF162436.9516 ●	GF162736.9516 ●
2	27	19,9	20	105	32,9	50	5	GF162156.9516 ●	GF162456.9516 ●	GF162756.9516 ●
3	24	15,9	16	90	28,3	48	5	GF162136.9518 ●	GF162436.9518 ●	GF162736.9518 ●
3	30	19,9	20	105	34,9	50	5	GF162156.9518 ●	GF162456.9518 ●	GF162756.9518 ●

Andere Steigungen auf Anfrage
Tools for different thread pitch upon request

Product Finder

v_c / f_z

M

MF

UNC
UN, UNS

UNF
UNEF

G, Rp

NPT, NPTF
Rc, W

BSW, BSF

Pg

EG (STI)
SELF-LOCK

Tr

Zubehör
Accessories

Tech. Info

BGF

ZBGF

GSF

GF

GF-KEG

ZGF

ZIRK-GF

Gigant

MoSys

- Product Finder
- v_c / f_z
- M
- MF
- UNC
UN, UNS
- UNF
UNEF
- G, Rp
- NPT, NPTF
Rc, W
- BSW, BSF
- Pg
- EG (STI)
SELF-LOCK
- Tr
- Zubehör
Accessories
- Tech. Info
- BGF
- ZBGF
- GSF
- GF
- GF-KEG
- ZGF
- ZIRK-GF
- Gigant
- MoSys

M, MF

DIN 13

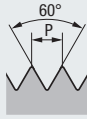
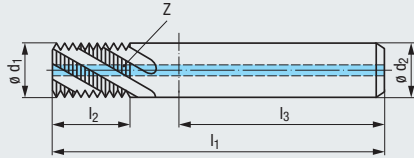
Für Innengewinde
 For internal threads

VHM
R30
RH + LH
Z4 - Z5
DIN 6535

 Einsatzgebiete – Material
 Applications – material

» 328

P 1.1-3.1	K 1.1-4.2	N 1.1-5
N 2.1-6	N 3.1-4.2, 5.2	S 1.1-2

P mm	$\varnothing D_{min.}$ mm	$\varnothing d_1$ mm	$\varnothing d_2$	l_1	l_2	l_3	Z	GF-VHM R30-Ig-IKZ-HB		GF-VHM R30-Ig-IKZ-HE		GF-VHM R30-Ig-IKZ-HA	
								●	●	●	●	●	●
1	14	9,9	10	80	20,4	40	4	GF162311.9512	●	GF162611.9512	●	GF162911.9512	●
1	16	11,9	12	90	25,4	45	4	GF162321.9512	●	GF162621.9512	●	GF162921.9512	●
1	22	15,9	16	100	32,4	48	5	GF162331.9512	●	GF162631.9512	●	GF162931.9512	●
1	27	19,9	20	115	40,4	50	5	GF162351.9512	●	GF162651.9512	●	GF162951.9512	●
1,5	14	9,9	10	80	21,6	40	4	GF162311.9514	●	GF162611.9514	●	GF162911.9514	●
1,5	16	11,9	12	90	26,1	45	4	GF162321.9514	●	GF162621.9514	●	GF162921.9514	●
1,5	22	15,9	16	100	33,6	48	5	GF162331.9514	●	GF162631.9514	●	GF162931.9514	●
1,5	27	19,9	20	115	41,1	50	5	GF162351.9514	●	GF162651.9514	●	GF162951.9514	●
2	18	11,9	12	90	26,9	45	4	GF162321.9516	●	GF162621.9516	●	GF162921.9516	●
2	22	15,9	16	100	32,9	48	5	GF162331.9516	●	GF162631.9516	●	GF162931.9516	●
2	27	19,9	20	115	40,9	50	5	GF162351.9516	●	GF162651.9516	●	GF162951.9516	●
3	24	15,9	16	100	34,3	48	5	GF162331.9518	●	GF162631.9518	●	GF162931.9518	●
3	30	19,9	20	115	43,3	50	5	GF162351.9518	●	GF162651.9518	●	GF162951.9518	●

TICN

 Einsatzgebiete – Material
 Applications – material

» 328

P 1.1-3.1	M 1.1-2.1	K 1.1-4.2
N 1.1-2.7	N 3.1-5.2	S 1.1-2, 2.1

P mm	$\varnothing D_{min.}$ mm	$\varnothing d_1$ mm	$\varnothing d_2$	l_1	l_2	l_3	Z	GF-VHM R30-Ig-IKZ-HB TICN		GF-VHM R30-Ig-IKZ-HE TICN		GF-VHM R30-Ig-IKZ-HA TICN	
								●	●	●	●	●	●
1	14	9,9	10	80	20,4	40	4	GF162316.9512	●	GF162616.9512	●	GF162916.9512	●
1	16	11,9	12	90	25,4	45	4	GF162326.9512	●	GF162626.9512	●	GF162926.9512	●
1	22	15,9	16	100	32,4	48	5	GF162336.9512	●	GF162636.9512	●	GF162936.9512	●
1	27	19,9	20	115	40,4	50	5	GF162356.9512	●	GF162656.9512	●	GF162956.9512	●
1,5	14	9,9	10	80	21,6	40	4	GF162316.9514	●	GF162616.9514	●	GF162916.9514	●
1,5	16	11,9	12	90	26,1	45	4	GF162326.9514	●	GF162626.9514	●	GF162926.9514	●
1,5	22	15,9	16	100	33,6	48	5	GF162336.9514	●	GF162636.9514	●	GF162936.9514	●
1,5	27	19,9	20	115	41,1	50	5	GF162356.9514	●	GF162656.9514	●	GF162956.9514	●
2	18	11,9	12	90	26,9	45	4	GF162326.9516	●	GF162626.9516	●	GF162926.9516	●
2	22	15,9	16	100	32,9	48	5	GF162336.9516	●	GF162636.9516	●	GF162936.9516	●
2	27	19,9	20	115	40,9	50	5	GF162356.9516	●	GF162656.9516	●	GF162956.9516	●
3	24	15,9	16	100	34,3	48	5	GF162336.9518	●	GF162636.9518	●	GF162936.9518	●
3	30	19,9	20	115	43,3	50	5	GF162356.9518	●	GF162656.9518	●	GF162956.9518	●

 Andere Steigungen auf Anfrage
 Tools for different thread pitch upon request

M, MF

DIN 13

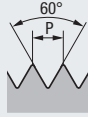

Für Außengewinde
For external threads

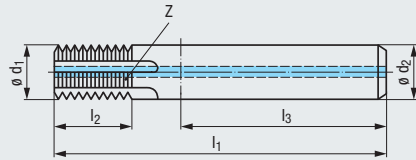

VHM

RH + LH

Z4 - Z5



DIN 6535



Einsatzgebiete – Material
Applications – material

» 328

P 1.1-5.1 K 1.1-4.2 N 1.1-5, 2.1-6
N 3.1-2 N 4.1-2, 5.2 S 1.1-3

P mm	∅ D _{min.} mm	∅ d ₁ mm	∅ d ₂	l ₁	l ₂	l ₃	Z	GF-VHM Ext.-IKZ-HB	GF-VHM Ext.-IKZ-HE	GF-VHM Ext.-IKZ-HA
1	10	9,9	10	70	16,5	40	4	GF161211.9512 ●	GF161511.9512 ●	GF161811.9512 ●
1	12	11,9	12	80	20,5	45	4	GF161121.9512 ●	GF161421.9512 ●	GF161721.9512 ●
1,5	12	11,9	12	80	21,75	45	4	GF161121.9514 ●	GF161421.9514 ●	GF161721.9514 ●
1,5	16	15,9	16	90	26,25	48	5	GF161131.9514 ●	GF161431.9514 ●	GF161731.9514 ●
1,5	20	19,9	20	105	33,75	50	5	GF161151.9514 ●	GF161451.9514 ●	GF161751.9514 ●
2	16	15,9	16	90	27	48	5	GF161131.9516 ●	GF161431.9516 ●	GF161731.9516 ●
2	20	19,9	20	105	33	50	5	GF161151.9516 ●	GF161451.9516 ●	GF161751.9516 ●
3	20	19,9	20	105	34,5	50	5	GF161151.9518 ●	GF161451.9518 ●	GF161751.9518 ●

TICN



Einsatzgebiete – Material
Applications – material

» 328

P 1.1-5.1 M 1.1-4.1 K 1.1-4.2
N 1.1-5.2 S 1.1-2.6 H 1.1-2

P mm	∅ D _{min.} mm	∅ d ₁ mm	∅ d ₂	l ₁	l ₂	l ₃	Z	GF-VHM Ext.-IKZ-HB TICN	GF-VHM Ext.-IKZ-HE TICN	GF-VHM Ext.-IKZ-HA TICN
1	10	9,9	10	70	16,5	40	4	GF161216.9512 ●	GF161516.9512 ●	GF161816.9512 ●
1	12	11,9	12	80	20,5	45	4	GF161126.9512 ●	GF161426.9512 ●	GF161726.9512 ●
1,5	12	11,9	12	80	21,75	45	4	GF161126.9514 ●	GF161426.9514 ●	GF161726.9514 ●
1,5	16	15,9	16	90	26,25	48	5	GF161136.9514 ●	GF161436.9514 ●	GF161736.9514 ●
1,5	20	19,9	20	105	33,75	50	5	GF161156.9514 ●	GF161456.9514 ●	GF161756.9514 ●
2	16	15,9	16	90	27	48	5	GF161136.9516 ●	GF161436.9516 ●	GF161736.9516 ●
2	20	19,9	20	105	33	50	5	GF161156.9516 ●	GF161456.9516 ●	GF161756.9516 ●
3	20	19,9	20	105	34,5	50	5	GF161156.9518 ●	GF161456.9518 ●	GF161756.9518 ●

Andere Steigungen auf Anfrage

Tools for different thread pitch upon request

Mit Rechtsspiralnuten auf Anfrage

With right-hand spiral flutes upon request

Product
Finder

v_c / f_z

M

MF

UNC
UN, UNS

UNF
UNEF

G, Rp

NPT, NPTF
Rc, W

BSW, BSF

Pg

EG (STI)
SELF-LOCK

Tr

Zubehör
Accessories

Tech. Info

BGF

ZBGF

GSF

GF

GF-KEG

ZGF

ZIRK-GF

Gigant

MoSys



Product Finder

v_c / f_z

M

MF

UNC
UN, UNS

UNF
UNEF

G, Rp

NPT, NPTF
Rc, W

BSW, BSF

Pg

EG (STI)
SELF-LOCK

Tr

Zubehör
Accessories

Tech. Info

BGF

ZBGF

GSF

GF

GF-KEG

ZGF

ZIRK-GF

Gigant

MoSys

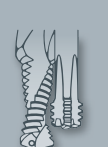

M, MF

DIN 13

Für Innengewinde
For internal threads

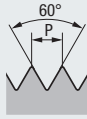
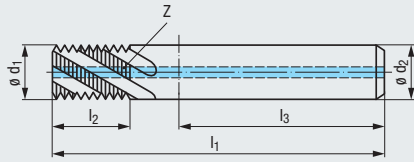

VHM

R15

RH + LH

Z6

DIN 6535

HB
HE
HA

$\varnothing D$

Mit höherer Nutenzahl
With increased number of flutes

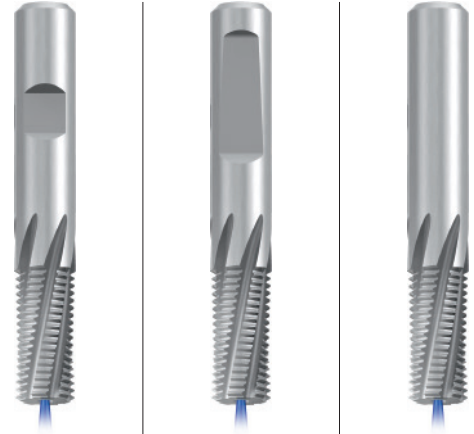

Einsatzgebiete – Material
Applications – material

» 328

P 1.1-5.1 K 1.1-4.2 N 1.1-5, 2.1-6
N 3.1-2 N 4.1-2, 5.2 S 1.1-3

P mm	$\varnothing D_{min.}$ mm	$\varnothing d_1$ mm	$\varnothing d_2$	l_1	l_2	l_3	Z	GF-Z-VHM R15- IKZ-HB	GF-Z-VHM R15- IKZ-HE	GF-Z-VHM R15- IKZ-HA
1	14	9,9	10	70	20,4	40	6	GF165361.9512	GF165661.9512	GF165961.9512
1,5	16	11,9	12	80	26,1	45	6	GF165371.9514	GF165671.9514	GF165971.9514
2	22	15,9	16	90	32,9	48	6	GF165381.9516	GF165681.9516	GF165981.9516
3	30	19,9	20	105	43,3	50	6	GF165391.9518	GF165691.9518	GF165991.9518

TICN



Einsatzgebiete – Material
Applications – material

» 328

P 1.1-5.1 M 1.1-4.1 K 1.1-4.2
N 1.1-5.2 S 1.1-2.6 H 1.1-2

P mm	$\varnothing D_{min.}$ mm	$\varnothing d_1$ mm	$\varnothing d_2$	l_1	l_2	l_3	Z	GF-Z-VHM R15- IKZ-HB TICN	GF-Z-VHM R15- IKZ-HE TICN	GF-Z-VHM R15- IKZ-HA TICN
1	14	9,9	10	70	20,4	40	6	GF165366.9512	GF165666.9512	GF165966.9512
1,5	16	11,9	12	80	26,1	45	6	GF165376.9514	GF165676.9514	GF165976.9514
2	22	15,9	16	90	32,9	48	6	GF165386.9516	GF165686.9516	GF165986.9516
3	30	19,9	20	105	43,3	50	6	GF165396.9518	GF165696.9518	GF165996.9518

Andere Steigungen auf Anfrage
Tools for different thread pitch upon request

M, MF

DIN 13



VHM

R15

RH + LH

Z4 - Z6



DIN 6535



Ø D



Für Innengewinde
For internal threads

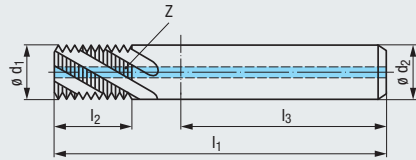

Einsatzgebiete – Material
Applications – material

» 328

Mit höherer Nutenzahl
With increased number of flutes

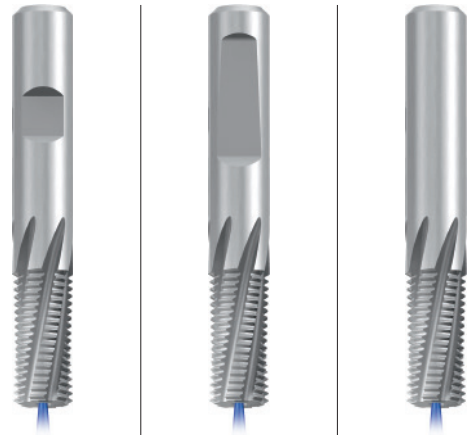

P 1.1-5.1 K 1.1-4.2 N 1.1-5, 2.1-6
N 3.1-2 N 4.1-2, 5.2 S 1.1-3

P mm	Ø D	Ø d ₁ mm	Ø d ₂	l ₁	l ₂	l ₃	Z	GF-VZ-VHM R15-IKZ-HB	GF-VZ-VHM R15-IKZ-HE	GF-VZ-VHM R15-IKZ-HA
0,5	≥ M 3	2,4	6	51	6,2	36	4	GFB35101.0030 ●	GFB35401.0030 ●	GFB35701.0030 ●
0,7	≥ M 4	3,15	6	55	8,7	36	4	GFB35101.0040 ●	GFB35401.0040 ●	GFB35701.0040 ●
0,8	≥ M 5	4	6	55	10,8	36	4	GFB35101.0050 ●	GFB35401.0050 ●	GFB35701.0050 ●
1	≥ M 6	4,8	6	55	12,4	36	4	GFB35101.0060 ●	GFB35401.0060 ●	GFB35701.0060 ●
1,25	≥ M 8	6,5	8	63	16,8	36	4	GFB35101.0080 ●	GFB35401.0080 ●	GFB35701.0080 ●
1,5	≥ M10	8,2	10	70	21,7	40	5	GFB35101.0100 ●	GFB35401.0100 ●	GFB35701.0100 ●
1,75	≥ M12	9,9	10	74	25,3	40	5	GFB35101.0112 ●	GFB35401.0112 ●	GFB35701.0112 ●
2	≥ M14	11,6	12	85	28,9	45	5	GFB35101.0114 ●	GFB35401.0114 ●	GFB35701.0114 ●
2,5	≥ M18	15	16	100	38,6	48	5	GFB35101.0118 ●	GFB35401.0118 ●	GFB35701.0118 ●
3	≥ M24	19,9	20	115	49,4	50	6	GFB35101.0124 ●	GFB35401.0124 ●	GFB35701.0124 ●

TICN



Einsatzgebiete – Material
Applications – material

» 328

P 1.1-5.1 M 1.1-4.1 K 1.1-4.2
N 1.1-5.2 S 1.1-2.6 H 1.1-2

P mm	Ø D	Ø d ₁ mm	Ø d ₂	l ₁	l ₂	l ₃	Z	GF-VZ-VHM R15-IKZ-HB TICN	GF-VZ-VHM R15-IKZ-HE TICN	GF-VZ-VHM R15-IKZ-HA TICN
0,5	≥ M 3	2,4	6	51	6,2	36	4	GFB35106.0030 ●	GFB35406.0030 ●	GFB35706.0030 ●
0,7	≥ M 4	3,15	6	55	8,7	36	4	GFB35106.0040 ●	GFB35406.0040 ●	GFB35706.0040 ●
0,8	≥ M 5	4	6	55	10,8	36	4	GFB35106.0050 ●	GFB35406.0050 ●	GFB35706.0050 ●
1	≥ M 6	4,8	6	55	12,4	36	4	GFB35106.0060 ●	GFB35406.0060 ●	GFB35706.0060 ●
1,25	≥ M 8	6,5	8	63	16,8	36	4	GFB35106.0080 ●	GFB35406.0080 ●	GFB35706.0080 ●
1,5	≥ M10	8,2	10	70	21,7	40	5	GFB35106.0100 ●	GFB35406.0100 ●	GFB35706.0100 ●
1,75	≥ M12	9,9	10	74	25,3	40	5	GFB35106.0112 ●	GFB35406.0112 ●	GFB35706.0112 ●
2	≥ M14	11,6	12	85	28,9	45	5	GFB35106.0114 ●	GFB35406.0114 ●	GFB35706.0114 ●
2,5	≥ M18	15	16	100	38,6	48	5	GFB35106.0118 ●	GFB35406.0118 ●	GFB35706.0118 ●
3	≥ M24	19,9	20	115	49,4	50	6	GFB35106.0124 ●	GFB35406.0124 ●	GFB35706.0124 ●

Andere Steigungen auf Anfrage
Tools for different thread pitch upon request

Product Finder

v_c / f_z

M

MF

UNC
UN, UNS

UNF
UNEF

G, Rp

NPT, NPTF
Rc, W

BSW, BSF

Pg

EG (STI)
SELF-LOCK

Tr

Zubehör
Accessories

Tech. Info

BGF

ZBGF

GSF

GF

GF-KEG

ZGF

ZIRK-GF

Gigant

MoSys



Product Finder

v_c / f_z

M

MF

UNC
UN, UNS

UNF
UNEF

G, Rp

NPT, NPTF
Rc, W

BSW, BSF

Pg

EG (STI)
SELF-LOCK

Tr

Zubehör
Accessories

Tech. Info

BGF

ZBGF

GSF

GF

GF-KEG

ZGF

ZIRK-GF

Gigant

MoSys

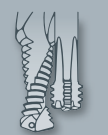

MF

DIN 13

Für Innengewinde
For internal threads

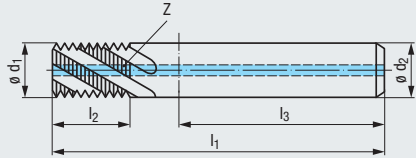

VHM

R15

RH + LH

Z4 - Z5

DIN 6535



$\varnothing D$



Mit höherer Nutenzahl
With increased number of flutes

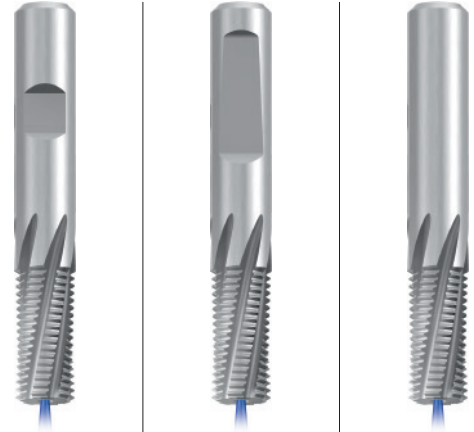

Einsatzgebiete – Material
Applications – material

» 328

P 1.1-5.1 K 1.1-4.2 N 1.1-5, 2.1-6
N 3.1-2 N 4.1-2, 5.2 S 1.1-3

P mm	$\varnothing D$	$\varnothing d_1$ mm	$\varnothing d_2$	l_1	l_2	l_3	Z
1	$\geq M 8$	6,7	8	63	16,4	36	4
1	$\geq M10$	8,7	10	70	20,4	40	5
1,5	$\geq M16$	14,1	16	95	33,7	48	5

GF-VZ-VHM R15- IKZ-HB	GF-VZ-VHM R15- IKZ-HE	GF-VZ-VHM R15- IKZ-HA
GFB35101.0251 ●	GFB35401.0251 ●	GFB35701.0251 ●
GFB35101.0276 ●	GFB35401.0276 ●	GFB35701.0276 ●
GFB35101.0359 ●	GFB35401.0359 ●	GFB35701.0359 ●

TICN



Einsatzgebiete – Material
Applications – material

» 328

P 1.1-5.1 M 1.1-4.1 K 1.1-4.2
N 1.1-5.2 S 1.1-2.6 H 1.1-2

P mm	$\varnothing D$	$\varnothing d_1$ mm	$\varnothing d_2$	l_1	l_2	l_3	Z
1	$\geq M 8$	6,7	8	63	16,4	36	4
1	$\geq M10$	8,7	10	70	20,4	40	5
1,5	$\geq M16$	14,1	16	95	33,7	48	5

GF-VZ-VHM R15- IKZ-HB TICN	GF-VZ-VHM R15- IKZ-HE TICN	GF-VZ-VHM R15- IKZ-HA TICN
GFB35106.0251 ●	GFB35406.0251 ●	GFB35706.0251 ●
GFB35106.0276 ●	GFB35406.0276 ●	GFB35706.0276 ●
GFB35106.0359 ●	GFB35406.0359 ●	GFB35706.0359 ●

Andere Steigungen auf Anfrage
Tools for different thread pitch upon request

M



DIN 13

Für Innengewinde
For internal threads

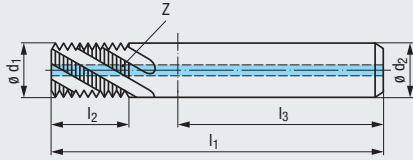

VHM	TICN
R10	RH + LH
Z4 - Z5	DIN 6535 HB HE HA
	$\varnothing D$

Für die Hartbearbeitung
For hard materials

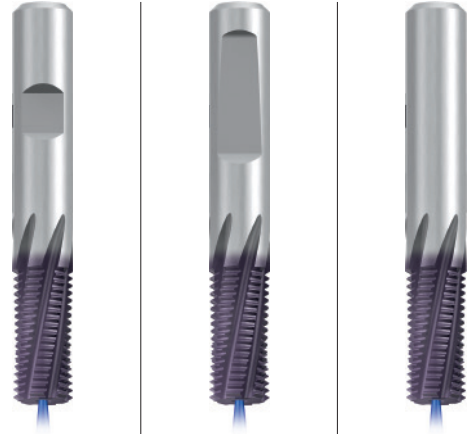

Einsatzgebiete – Material
Applications – material

N 2.7-8 H 1.3-5

$\varnothing D$ mm	P mm	$\varnothing d_1$ mm	$\varnothing d_2$	l_1	l_2	l_3	Z	GF-H-VHM R10- IKZ -HB TICN	GF-H-VHM R10- IKZ -HE TICN	GF-H-VHM R10- IKZ -HA TICN
M 6	1	4,6	6	55	9,4	36	4	GF927126.0060 ●	GF927426.0060 ●	GF927726.0060 ●
8	1,25	6,25	8	63	13,1	36	5	GF927126.0080 ●	GF927426.0080 ●	GF927726.0080 ●
10	1,5	7,9	8	63	15,7	36	5	GF927126.0100 ●	GF927426.0100 ●	GF927726.0100 ●
12	1,75	9,55	10	70	18,3	40	5	GF927126.0112 ●	GF927426.0112 ●	GF927726.0112 ●
16	2	13,2	14	90	24,9	45	5	GF927126.0116 ●	GF927426.0116 ●	GF927726.0116 ●
20	2,5	15,9	16	100	33,6	48	5	GF927126.0120 ●	GF927426.0120 ●	GF927726.0120 ●

Andere Steigungen auf Anfrage
Tools for different thread pitch upon request

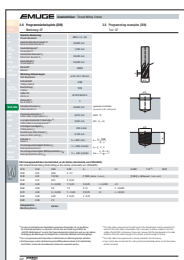

Programmierbeispiel für Gewindefräser
Typ GF siehe Seite 466

Programming example for thread milling
cutters type GF, see page 466

Product Finder

v_c / f_z

M

MF

UNC
UN, UNS

UNF
UNEF

G, Rp

NPT, NPTF
Rc, W

BSW, BSF

Pg

EG (STI)
SELF-LOCK

Tr

Zubehör
Accessories

Tech. Info

BGF

ZBGF

GSF

GF

GF-KEG

ZGF

ZIRK-GF

Gigant

MoSys

Product Finder

v_c / f_z

M

MF

UNC
UN, UNS

UNF
UNEF

G, Rp

NPT, NPTF
Rc, W

BSW, BSF

Pg

EG (STI)
SELF-LOCK

Tr

Zubehör
Accessories

Tech. Info

BGF

ZBGF

GSF

GF

GF-KEG

ZGF

ZIRK-GF

Gigant

MoSys

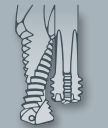

ASME B1.1

Für Innengewinde
For internal threads

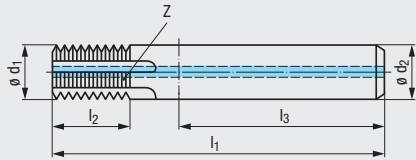

VHM

RH + LH

Z4 - Z5



DIN 6535



$\varnothing D$



Einsatzgebiete – Material
Applications – material

» 328

P 1.1-5.1 K 1.1-4.2 N 1.1-5, 2.1-6
N 3.1-2 N 4.1-2, 5.2 S 1.1-3

P Gg/1" (tpi)	$\varnothing D_{min}$ inch	$\varnothing d_1$ mm	$\varnothing d_2$	l_1	l_2	l_3	Z	GF-VHM IKZ-HB	GF-VHM IKZ-HE	GF-VHM IKZ-HA
24	1/2	9,9	10	70	16,3	40	4	GF163211.9579	● GF163511.9579	● GF163811.9579
20	1/2	9,9	10	70	17,1	40	4	GF163211.9580	● GF163511.9580	● GF163811.9580
20	11/16	11,9	12	80	20,9	45	4	GF163121.9580	● GF163421.9580	● GF163721.9580
20	7/8	15,9	16	90	25,9	48	5	GF163131.9580	● GF163431.9580	● GF163731.9580
20	1"	19,9	20	105	32,3	50	5	GF163151.9580	● GF163451.9580	● GF163751.9580
18	1/2	9,9	10	70	17,5	40	4	GF163211.9581	● GF163511.9581	● GF163811.9581
16	1/2	9,9	10	70	16,6	40	4	GF163211.9582	● GF163511.9582	● GF163811.9582
16	11/16	11,9	12	80	21,3	45	4	GF163121.9582	● GF163421.9582	● GF163721.9582
16	7/8	15,9	16	90	26,2	48	5	GF163131.9582	● GF163431.9582	● GF163731.9582
16	1"	19,9	20	105	32,4	50	5	GF163151.9582	● GF163451.9582	● GF163751.9582
14	7/8	15,9	16	90	26,2	48	5	GF163131.9583	● GF163431.9583	● GF163731.9583
12	11/16	11,9	12	80	22,1	45	4	GF163121.9585	● GF163421.9585	● GF163721.9585
12	7/8	15,9	16	90	26,3	48	5	GF163131.9585	● GF163431.9585	● GF163731.9585
12	1"	19,9	20	105	32,7	50	5	GF163151.9585	● GF163451.9585	● GF163751.9585
10	11/16	11,9	12	80	21,4	45	4	GF163121.9587	● GF163421.9587	● GF163721.9587
9	11/16	11,9	12	80	21	45	4	GF163121.9588	● GF163421.9588	● GF163721.9588
8	7/8	15,9	16	90	26,8	48	5	GF163131.9589	● GF163431.9589	● GF163731.9589
8	1"	19,9	20	105	33,2	50	5	GF163151.9589	● GF163451.9589	● GF163751.9589
6	1"	19,9	20	105	35,8	50	5	GF163151.9591	● GF163451.9591	● GF163751.9591

TICN



Einsatzgebiete – Material
Applications – material

» 328

P 1.1-5.1 M 1.1-4.1 K 1.1-4.2
N 1.1-5.2 S 1.1-2.6 H 1.1-2

P Gg/1" (tpi)	$\varnothing D_{min}$ inch	$\varnothing d_1$ mm	$\varnothing d_2$	l_1	l_2	l_3	Z	GF-VHM IKZ-HB TICN	GF-VHM IKZ-HE TICN	GF-VHM IKZ-HA TICN
24	1/2	9,9	10	70	16,3	40	4	GF163216.9579	● GF163516.9579	● GF163816.9579
20	1/2	9,9	10	70	17,1	40	4	GF163216.9580	● GF163516.9580	● GF163816.9580
20	11/16	11,9	12	80	20,9	45	4	GF163126.9580	● GF163426.9580	● GF163726.9580
20	7/8	15,9	16	90	25,9	48	5	GF163136.9580	● GF163436.9580	● GF163736.9580
20	1"	19,9	20	105	32,3	50	5	GF163156.9580	● GF163456.9580	● GF163756.9580
18	1/2	9,9	10	70	17,5	40	4	GF163216.9581	● GF163516.9581	● GF163816.9581
16	1/2	9,9	10	70	16,6	40	4	GF163216.9582	● GF163516.9582	● GF163816.9582
16	11/16	11,9	12	80	21,3	45	4	GF163126.9582	● GF163426.9582	● GF163726.9582
16	7/8	15,9	16	90	26,2	48	5	GF163136.9582	● GF163436.9582	● GF163736.9582
16	1"	19,9	20	105	32,4	50	5	GF163156.9582	● GF163456.9582	● GF163756.9582
14	7/8	15,9	16	90	26,2	48	5	GF163136.9583	● GF163436.9583	● GF163736.9583
12	11/16	11,9	12	80	22,1	45	4	GF163126.9585	● GF163426.9585	● GF163726.9585
12	7/8	15,9	16	90	26,3	48	5	GF163136.9585	● GF163436.9585	● GF163736.9585
12	1"	19,9	20	105	32,7	50	5	GF163156.9585	● GF163456.9585	● GF163756.9585
10	11/16	11,9	12	80	21,4	45	4	GF163126.9587	● GF163426.9587	● GF163726.9587
9	11/16	11,9	12	80	21	45	4	GF163126.9588	● GF163426.9588	● GF163726.9588
8	7/8	15,9	16	90	26,8	48	5	GF163136.9589	● GF163436.9589	● GF163736.9589
8	1"	19,9	20	105	33,2	50	5	GF163156.9589	● GF163456.9589	● GF163756.9589
6	1"	19,9	20	105	35,8	50	5	GF163156.9591	● GF163456.9591	● GF163756.9591

Andere Steigungen auf Anfrage
Tools for different thread pitch upon request



ASME B1.1

Für Innengewinde
For internal threads

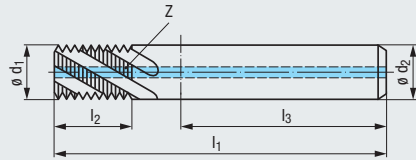

VHM

R30 **RH + LH**

Z4 - Z5 **DIN 6535**
 HB
 HE
 HA

$\varnothing D$

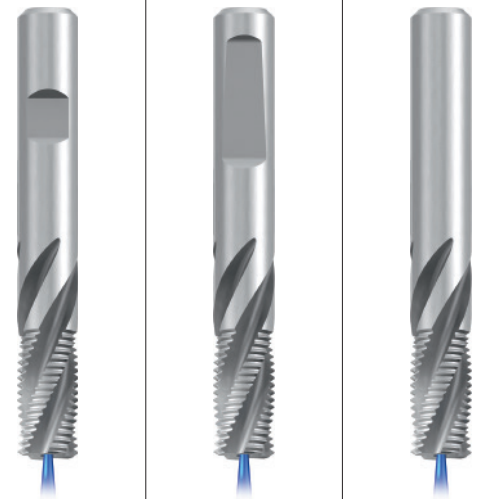

Einsatzgebiete – Material
Applications – material

» 328

P 1.1-3.1 **K** 1.1-4.2 **N** 1.1-5
N 2.1-6 **N** 3.1-4.2, 5.2 **S** 1.1-2

P Gg/1" (tpi)	$\varnothing D_{min.}$ inch	$\varnothing d_1$ mm	$\varnothing d_2$	l_1	l_2	l_3	Z	GF-VHM R30-Ig-IKZ-HB	GF-VHM R30-Ig-IKZ-HE	GF-VHM R30-Ig-IKZ-HA			
24	1/2	9,9	10	80	20,6	40	4	GF162311.9579	●	GF162611.9579	●	GF162911.9579	●
20	1/2	9,9	10	80	20,9	40	4	GF162311.9580	●	GF162611.9580	●	GF162911.9580	●
20	11/16	11,9	12	90	26	45	4	GF162321.9580	●	GF162621.9580	●	GF162921.9580	●
20	7/8	15,9	16	100	32,3	48	5	GF162331.9580	●	GF162631.9580	●	GF162931.9580	●
20	1"	19,9	20	115	41,2	50	5	GF162351.9580	●	GF162651.9580	●	GF162951.9580	●
18	1/2	9,9	10	80	20,4	40	4	GF162311.9581	●	GF162611.9581	●	GF162911.9581	●
16	1/2	9,9	10	80	21,3	40	4	GF162311.9582	●	GF162611.9582	●	GF162911.9582	●
16	11/16	11,9	12	90	26,1	45	4	GF162321.9582	●	GF162621.9582	●	GF162921.9582	●
16	7/8	15,9	16	100	32,4	48	5	GF162331.9582	●	GF162631.9582	●	GF162931.9582	●
16	1"	19,9	20	115	40,4	50	5	GF162351.9582	●	GF162651.9582	●	GF162951.9582	●
14	7/8	15,9	16	100	33,4	48	5	GF162331.9583	●	GF162631.9583	●	GF162931.9583	●
12	11/16	11,9	12	90	26,3	45	4	GF162321.9585	●	GF162621.9585	●	GF162921.9585	●
12	7/8	15,9	16	100	32,7	48	5	GF162331.9585	●	GF162631.9585	●	GF162931.9585	●
12	1"	19,9	20	115	41,1	50	5	GF162351.9585	●	GF162651.9585	●	GF162951.9585	●
10	11/16	11,9	12	90	26,5	45	4	GF162321.9587	●	GF162621.9587	●	GF162921.9587	●
9	11/16	11,9	12	90	26,6	45	4	GF162321.9588	●	GF162621.9588	●	GF162921.9588	●
8	7/8	15,9	16	100	33,1	48	5	GF162331.9589	●	GF162631.9589	●	GF162931.9589	●
8	1"	19,9	20	115	42,7	50	5	GF162351.9589	●	GF162651.9589	●	GF162951.9589	●
6	1"	19,9	20	115	44,3	50	5	GF162351.9591	●	GF162651.9591	●	GF162951.9591	●

TICN



Einsatzgebiete – Material
Applications – material

» 328

P 1.1-3.1 **M** 1.1-2.1 **K** 1.1-4.2
N 1.1-2.7 **N** 3.1-5.2 **S** 1.1-2, 2.1

P Gg/1" (tpi)	$\varnothing D_{min.}$ inch	$\varnothing d_1$ mm	$\varnothing d_2$	l_1	l_2	l_3	Z	GF-VHM R30-Ig-IKZ-HB TICN	GF-VHM R30-Ig-IKZ-HE TICN	GF-VHM R30-Ig-IKZ-HA TICN			
24	1/2	9,9	10	80	20,6	40	4	GF162316.9579	●	GF162616.9579	●	GF162916.9579	●
20	1/2	9,9	10	80	20,9	40	4	GF162316.9580	●	GF162616.9580	●	GF162916.9580	●
20	11/16	11,9	12	90	26	45	4	GF162326.9580	●	GF162626.9580	●	GF162926.9580	●
20	7/8	15,9	16	100	32,3	48	5	GF162336.9580	●	GF162636.9580	●	GF162936.9580	●
20	1"	19,9	20	115	41,2	50	5	GF162356.9580	●	GF162656.9580	●	GF162956.9580	●
18	1/2	9,9	10	80	20,4	40	4	GF162316.9581	●	GF162616.9581	●	GF162916.9581	●
16	1/2	9,9	10	80	21,3	40	4	GF162316.9582	●	GF162616.9582	●	GF162916.9582	●
16	11/16	11,9	12	90	26,1	45	4	GF162326.9582	●	GF162626.9582	●	GF162926.9582	●
16	7/8	15,9	16	100	32,4	48	5	GF162336.9582	●	GF162636.9582	●	GF162936.9582	●
16	1"	19,9	20	115	40,4	50	5	GF162356.9582	●	GF162656.9582	●	GF162956.9582	●
14	7/8	15,9	16	100	33,4	48	5	GF162336.9583	●	GF162636.9583	●	GF162936.9583	●
12	11/16	11,9	12	90	26,3	45	4	GF162326.9585	●	GF162626.9585	●	GF162926.9585	●
12	7/8	15,9	16	100	32,7	48	5	GF162336.9585	●	GF162636.9585	●	GF162936.9585	●
12	1"	19,9	20	115	41,1	50	5	GF162356.9585	●	GF162656.9585	●	GF162956.9585	●
10	11/16	11,9	12	90	26,5	45	4	GF162326.9587	●	GF162626.9587	●	GF162926.9587	●
9	11/16	11,9	12	90	26,6	45	4	GF162326.9588	●	GF162626.9588	●	GF162926.9588	●
8	7/8	15,9	16	100	33,1	48	5	GF162336.9589	●	GF162636.9589	●	GF162936.9589	●
8	1"	19,9	20	115	42,7	50	5	GF162356.9589	●	GF162656.9589	●	GF162956.9589	●
6	1"	19,9	20	115	44,3	50	5	GF162356.9591	●	GF162656.9591	●	GF162956.9591	●

Andere Steigungen auf Anfrage
Tools for different thread pitch upon request

Product Finder

v_c / f_z

M

MF

UNC
UN, UNS

UNF
UNEF

G, Rp

NPT, NPTF
Rc, W

BSW, BSF

Pg

EG (STI)
SELF-LOCK

Tr

Zubehör
Accessories

Tech. Info

BGF

ZBGF

GSF

GF

GF-KEG

ZGF

ZIRK-GF

Gigant

MoSys

- Product Finder
- v_c / f_z
- M
- MF
- UNC
UN, UNS
- UNF
UNEF
- G, Rp
- NPT, NPTF
Rc, W
- BSW, BSF
- Pg
- EG (STI)
SELF-LOCK
- Tr
- Zubehör
Accessories
- Tech. Info
- BGF
- ZBGF
- GSF
- GF

UNC, UN

ASME B1.1

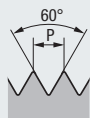

Für Innengewinde
For internal threads

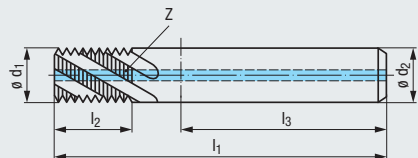

VHM **TICN**

R15 **RH + LH**

Z4 - Z6 **DIN 6535**
HB
HE
HA

Mit höherer Nutenzahl
With increased number of flutes

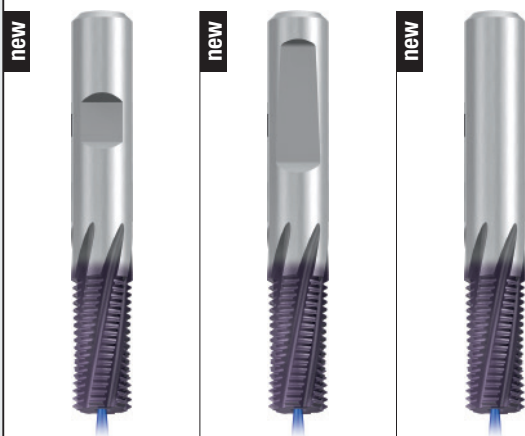

Einsatzgebiete – Material
Applications – material [» 328](#)

P 1.1-5.1 **M** 1.1-4.1 **K** 1.1-4.2
N 1.1-5.2 **S** 1.1-2.6 **H** 1.1-2

P Gg/1" (tpi)	$\varnothing D_{min.}$ inch	$\varnothing d_1$ mm	$\varnothing d_2$	l_1	l_2	l_3	Z	GF-VZ-VHM R15-IKZ-HB TICN	GF-VZ-VHM R15-IKZ-HE TICN	GF-VZ-VHM R15-IKZ-HA TICN
24	\geq Nr. 10	3,7	6	55	10	36	4	GFB35106.5007	● GFB35406.5007	● GFB35706.5007
20	\geq 1/4	4,95	6	58	13,3	36	4	GFB35106.5009	● GFB35406.5009	● GFB35706.5009
18	\geq 5/16	6,3	8	62	16,2	36	4	GFB35106.5010	● GFB35406.5010	● GFB35706.5010
16	\geq 3/8	7,65	8	65	19,8	36	5	GFB35106.5011	● GFB35406.5011	● GFB35706.5011
14	\geq 7/16	9	10	74	22,6	40	5	GFB35106.5012	● GFB35406.5012	● GFB35706.5012
13	\geq 1/2	10,4	12	80	26,3	45	5	GFB35106.5013	● GFB35406.5013	● GFB35706.5013
12	\geq 9/16	11,8	12	85	30,6	45	5	GFB35106.5014	● GFB35406.5014	● GFB35706.5014
11	\geq 5/8	13	14	90	33,4	45	5	GFB35106.5015	● GFB35406.5015	● GFB35706.5015
10	\geq 3/4	15,9	16	100	39,3	48	5	GFB35106.5016	● GFB35406.5016	● GFB35706.5016
9	\geq 7/8	18,9	20	110	46,5	50	6	GFB35106.5017	● GFB35406.5017	● GFB35706.5017
8	\geq 1"	21,6	25	125	52,3	56	6	GFB35106.5018	● GFB35406.5018	● GFB35706.5018

Andere Steigungen auf Anfrage
Tools for different thread pitch upon request

- ZIRK-GF
- Gigant
- MoSys

UNF, UN

ASME B1.1

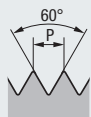

Für Innengewinde
For internal threads

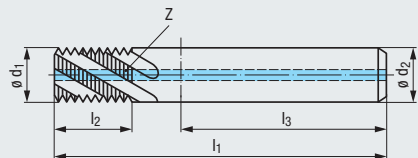

VHM **TICN**

R15 **RH + LH**

Z4 - Z8 **DIN 6535**
HB
HE
HA

Mit höherer Nutenzahl
With increased number of flutes

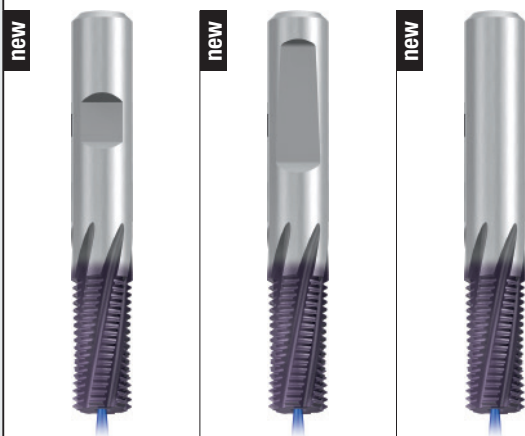

Einsatzgebiete – Material
Applications – material [» 328](#)

P 1.1-5.1 **M** 1.1-4.1 **K** 1.1-4.2
N 1.1-5.2 **S** 1.1-2.6 **H** 1.1-2

P Gg/1" (tpi)	$\varnothing D_{min.}$ inch	$\varnothing d_1$ mm	$\varnothing d_2$	l_1	l_2	l_3	Z	GF-VZ-VHM R15-IKZ-HB TICN	GF-VZ-VHM R15-IKZ-HE TICN	GF-VZ-VHM R15-IKZ-HA TICN
32	\geq Nr. 10	3,9	6	55	9,9	36	4	GFB35106.5041	● GFB35406.5041	● GFB35706.5041
28	\geq Nr. 12	4,45	6	58	11,3	36	4	GFB35106.5042	● GFB35406.5042	● GFB35706.5042
28	\geq 1/4	5,3	6	58	13,1	36	4	GFB35106.5043	● GFB35406.5043	● GFB35706.5043
24	\geq 5/16	6,6	8	62	16,4	36	5	GFB35106.5044	● GFB35406.5044	● GFB35706.5044
20	\geq 7/16	9,55	10	74	22,2	40	6	GFB35106.5046	● GFB35406.5046	● GFB35706.5046
18	\geq 9/16	12,5	14	85	28,9	45	7	GFB35106.5048	● GFB35406.5048	● GFB35706.5048
16	\geq 3/4	17	18	102	38,8	48	8	GFB35106.5050	● GFB35406.5050	● GFB35706.5050

Andere Steigungen auf Anfrage
Tools for different thread pitch upon request

G (BSP), Rp (BSPP), W

DIN EN ISO 228, DIN EN 10226-1, ISO 7/1, BS 84



VHM

RH + LH

Z4 - Z5



DIN 6535



Für Innen- und Außengewinde
For internal and external threads

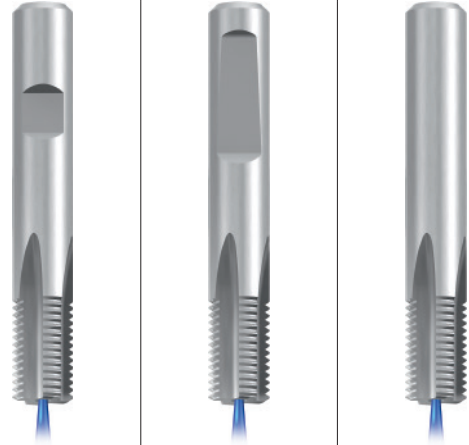
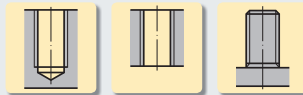
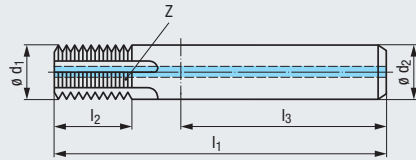

Einsatzgebiete – Material
Applications – material

» 328

P 1.1-5.1 K 1.1-4.2 N 1.1-5, 2.1-6
N 3.1-2 N 4.1-2, 5.2 S 1.1-3

P Gg/1" (tpi)	$\varnothing D_{min.}^{1)}$ inch	$\varnothing d_1$ mm	$\varnothing d_2$	l_1	l_2	l_3	Z	GF-VHM IKZ-HB	GF-VHM IKZ-HE	GF-VHM IKZ-HA
19	1/4	9,9	10	70	16,7	40	4	GF163211.9545 ●	GF163511.9545 ●	GF163811.9545 ●
14	1/2	15,9	16	90	26,3	48	5	GF163131.9548 ●	GF163431.9548 ●	GF163731.9548 ●
14	3/4	19,9	20	105	33,5	50	5	GF163151.9548 ●	GF163451.9548 ●	GF163751.9548 ●
11	1"	15,9	16	90	26,5	48	5	GF163131.9550 ●	GF163431.9550 ●	GF163731.9550 ●
11	1"	19,9	20	105	33,5	50	5	GF163151.9550 ●	GF163451.9550 ●	GF163751.9550 ●

TICN



Einsatzgebiete – Material
Applications – material

» 328

P 1.1-5.1 M 1.1-4.1 K 1.1-4.2
N 1.1-5.2 S 1.1-2.6 H 1.1-2

P Gg/1" (tpi)	$\varnothing D_{min.}^{1)}$ inch	$\varnothing d_1$ mm	$\varnothing d_2$	l_1	l_2	l_3	Z	GF-VHM IKZ-HB TICN	GF-VHM IKZ-HE TICN	GF-VHM IKZ-HA TICN
19	1/4	9,9	10	70	16,7	40	4	GF163216.9545 ●	GF163516.9545 ●	GF163816.9545 ●
14	1/2	15,9	16	90	26,3	48	5	GF163136.9548 ●	GF163436.9548 ●	GF163736.9548 ●
14	3/4	19,9	20	105	33,5	50	5	GF163156.9548 ●	GF163456.9548 ●	GF163756.9548 ●
11	1"	15,9	16	90	26,5	48	5	GF163136.9550 ●	GF163436.9550 ●	GF163736.9550 ●
11	1"	19,9	20	105	33,5	50	5	GF163156.9550 ●	GF163456.9550 ●	GF163756.9550 ●

¹⁾ Durchmesser bezogen auf Rohr-Innengewinde bzw. Rohr-Außengewinde
Diameter related to internal pipe thread resp. external pipe thread

Product
Finder

v_c / f_z

M

MF

UNC
UN, UNS

UNF
UNEF

G, Rp

NPT, NPTF
Rc, W

BSW, BSF

Pg

EG (STI)
SELF-LOCK

Tr

Zubehör
Accessories

Tech. Info

BGF

ZBGF

GSF

GF

GF-KEG

ZGF

ZIRK-GF

Gigant

MoSys



- Product Finder
- v_c / f_z
- M
- MF
- UNC UN, UNS
- UNF UNEF
- G, Rp
- NPT, NPTF R, W
- BSW, BSF
- Pg
- EG (STI) SELF-LOCK
- Tr
- Zubehör Accessories
- Tech. Info
- BGF
- ZBGF
- GSF
- GF
- GF-KEG
- ZGF
- ZIRK-GF
- Gigant
- MoSys

G (BSP), Rp (BSPP), W

DIN EN ISO 228, DIN EN 10226-1, ISO 7/1, BS 84

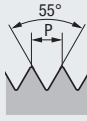

VHM

R30

RH + LH

Z4 - Z5



DIN 6535



Für Innen- und Außengewinde
For internal and external threads

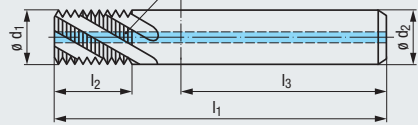

Einsatzgebiete – Material
Applications – material

» 328

P 1.1-3.1 K 1.1-4.2 N 1.1-5
N 2.1-6 N 3.1-4.2, 5.2 S 1.1-2

P Gg/1" (tpi)	$\varnothing D_{min.}^{1)}$ inch	$\varnothing d_1$ mm	$\varnothing d_2$	l_1	l_2	l_3	Z	GF-VHM R30-IKZ-HB	GF-VHM R30-IKZ-HE	GF-VHM R30-IKZ-HA
19	1/4	9,9	10	70	16,7	40	4	GF162211.9545	● GF162511.9545	● GF162811.9545
14	1/2	11,9	12	80	20,9	45	4	GF162121.9548	● GF162421.9548	● GF162721.9548
14	1/2	15,9	16	90	26,3	48	5	GF162131.9548	● GF162431.9548	● GF162731.9548
14	3/4	19,9	20	105	33,5	50	5	GF162151.9548	● GF162451.9548	● GF162751.9548
11	1"	15,9	16	90	26,5	48	5	GF162131.9550	● GF162431.9550	● GF162731.9550
11	1"	19,9	20	105	33,5	50	5	GF162151.9550	● GF162451.9550	● GF162751.9550

TICN



Einsatzgebiete – Material
Applications – material

» 328

P 1.1-3.1 M 1.1-2.1 K 1.1-4.2
N 1.1-2.7 N 3.1-5.2 S 1.1-2, 2.1

P Gg/1" (tpi)	$\varnothing D_{min.}^{1)}$ inch	$\varnothing d_1$ mm	$\varnothing d_2$	l_1	l_2	l_3	Z	GF-VHM R30-IKZ-HB TICN	GF-VHM R30-IKZ-HE TICN	GF-VHM R30-IKZ-HA TICN
19	1/4	9,9	10	70	16,7	40	4	GF162216.9545	● GF162516.9545	● GF162816.9545
14	1/2	11,9	12	80	20,9	45	4	GF162126.9548	● GF162426.9548	● GF162726.9548
14	1/2	15,9	16	90	26,3	48	5	GF162136.9548	● GF162436.9548	● GF162736.9548
14	3/4	19,9	20	105	33,5	50	5	GF162156.9548	● GF162456.9548	● GF162756.9548
11	1"	15,9	16	90	26,5	48	5	GF162136.9550	● GF162436.9550	● GF162736.9550
11	1"	19,9	20	105	33,5	50	5	GF162156.9550	● GF162456.9550	● GF162756.9550

¹⁾ Durchmesser bezogen auf Rohr-Innengewinde bzw. Rohr-Außengewinde
Diameter related to internal pipe thread resp. external pipe thread

G (BSP), Rp (BSPP), W

DIN EN ISO 228, DIN EN 10226-1, ISO 7/1, BS 84



Für Innengewinde
For internal threads

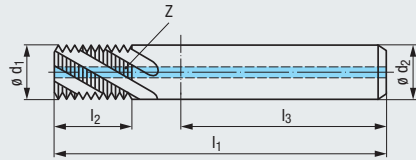

VHM

R15

RH + LH

Z5 - Z8



DIN 6535



Mit höherer Nutenzahl
With increased number of flutes

new



new



new



Einsatzgebiete – Material
Applications – material

» 328

P 1.1-5.1 K 1.1-4.2 N 1.1-5, 2.1-6
N 3.1-2 N 4.1-2, 5.2 S 1.1-3

P	$\varnothing D_{min.}$	$\varnothing d_1$	$\varnothing d_2$	l_1	l_2	l_3	Z	GF-Z-VHM R15-IKZ-HB	GF-Z-VHM R15-IKZ-HE	GF-Z-VHM R15-IKZ-HA
19	G 1/4	9,9	10	70	20,7	40	6	GF165361.9545 ●	GF165661.9545 ●	GF165961.9545 ●
14	G 1/2	11,9	12	80	26,3	45	5	GF165371.9548 ●	GF165671.9548 ●	GF165971.9548 ●
14	G 1/2	15,9	16	90	33,6	48	6	GF165381.9548 ●	GF165681.9548 ●	GF165981.9548 ●
14	G 3/4	19,9	20	105	40,8	50	8	GF165391.9548 ○	GF165691.9548 ○	GF165991.9548 ○
11	G 1"	15,9	16	90	33,5	48	5	GF165381.9550 ●	GF165681.9550 ●	GF165981.9550 ●
11	G 1"	19,9	20	105	42,7	50	6	GF165391.9550 ●	GF165691.9550 ●	GF165991.9550 ●

TICN

new



new



new



Einsatzgebiete – Material
Applications – material

» 328

P 1.1-5.1 M 1.1-4.1 K 1.1-4.2
N 1.1-5.2 S 1.1-2.6 H 1.1-2

P	$\varnothing D_{min.}$	$\varnothing d_1$	$\varnothing d_2$	l_1	l_2	l_3	Z	GF-Z-VHM R15-IKZ-HB TICN	GF-Z-VHM R15-IKZ-HE TICN	GF-Z-VHM R15-IKZ-HA TICN
19	G 1/4	9,9	10	70	20,7	40	6	GF165366.9545 ●	GF165666.9545 ●	GF165966.9545 ●
14	G 1/2	11,9	12	80	26,3	45	5	GF165376.9548 ●	GF165676.9548 ●	GF165976.9548 ●
14	G 1/2	15,9	16	90	33,6	48	6	GF165386.9548 ●	GF165686.9548 ●	GF165986.9548 ●
14	G 3/4	19,9	20	105	40,8	50	8	GF165396.9548 ○	GF165696.9548 ○	GF165996.9548 ○
11	G 1"	15,9	16	90	33,5	48	5	GF165386.9550 ●	GF165686.9550 ●	GF165986.9550 ●
11	G 1"	19,9	20	105	42,7	50	6	GF165396.9550 ●	GF165696.9550 ●	GF165996.9550 ●

Andere Steigungen auf Anfrage
Tools for different thread pitch upon request

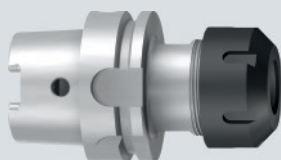

Spannzangen-Aufnahmen
Typ KSN/Synchro
siehe Seite 711 - 713

Collet holders
type KSN/Synchro,
see page 711 - 713



Product Finder

v_c / f_z

M

MF

UNC
UN, UNS

UNF
UNEF

G, Rp

NPT, NPTF
Rc, W

BSW, BSF

Pg

EG (STI)
SELF-LOCK

Tr

Zubehör
Accessories

Tech. Info

BGF

ZBGF

GSF

GF

GF-KEG

ZGF

ZIRK-GF

Gigant

MoSys



Pg

DIN 40430

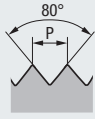

VHM

RH + LH

Z4



DIN 6535



Für Innen- und Außengewinde
For internal and external threads

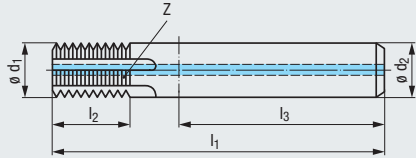

Einsatzgebiete – Material
Applications – material

» 328

P 1.1-5.1 K 1.1-4.2 N 1.1-5, 2.1-6
N 3.1-2 N 4.1-2, 5.2 S 1.1-3

Nenngröße

Nom. size

$\varnothing D^1)$

P

Gg/1" (tpi)

$\varnothing d_1$

mm

$\varnothing d_2$

mm

l_1

mm

l_2

mm

l_3

mm

Z

Pg

7

20

9,9

10

70

17,1

40

4

9

18

11,9

12

80

20,5

45

4

21

16

11,9

12

80

21,4

45

4

GF-VHM
IKZ-HB

GF-VHM
IKZ-HE

GF-VHM
IKZ-HA

GF163211.9661 ●

GF163121.9662 ●

GF163121.9663 ●

GF163511.9661 ●

GF163421.9662 ●

GF163421.9663 ●

GF163811.9661 ●

GF163721.9662 ●

GF163721.9663 ●

TICN



Einsatzgebiete – Material
Applications – material

» 328

P 1.1-5.1 M 1.1-4.1 K 1.1-4.2
N 1.1-5.2 S 1.1-2.6 H 1.1-2

Nenngröße

Nom. size

$\varnothing D^1)$

P

Gg/1" (tpi)

$\varnothing d_1$

mm

$\varnothing d_2$

mm

l_1

mm

l_2

mm

l_3

mm

Z

Pg

7

20

9,9

10

70

17,1

40

4

9

18

11,9

12

80

20,5

45

4

21

16

11,9

12

80

21,4

45

4

GF-VHM
IKZ-HB
TICN

GF-VHM
IKZ-HE
TICN

GF-VHM
IKZ-HA
TICN

GF163216.9661 ●

GF163126.9662 ●

GF163126.9663 ●

GF163516.9661 ●

GF163426.9662 ●

GF163426.9663 ●

GF163816.9661 ●

GF163726.9662 ●

GF163726.9663 ●

¹⁾ Durchmesser bezogen auf Rohr-Innengewinde bzw. Rohr-Außengewinde
Diameter related to internal pipe thread resp. external pipe thread

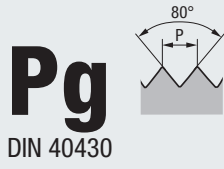

Pg
DIN 40430

VHM

R30 RH + LH

Z4 **DIN 6535**
HB
HE
HA

Ø D Ø D

Ø D

Für Innen- und Außengewinde
For internal and external threads

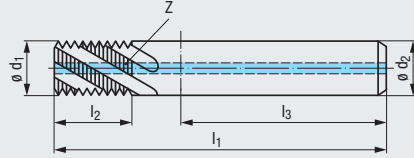

Einsatzgebiete – Material
Applications – material

P 1.1-3.1 K 1.1-4.2 N 1.1-5
N 2.1-6 N 3.1-4.2, 5.2 S 1.1-2

Nenngröße Nom. size Ø D ¹⁾	P Gg/1" (tpi)	Ø d ₁ mm	Ø d ₂	l ₁	l ₂	l ₃	Z						
								GF-VHM R30-IKZ-HB	GF-VHM R30-IKZ-HE	GF-VHM R30-IKZ-HA			
Pg 7	20	9,9	10	70	17,1	40	4	GF162211.9661	●	GF162511.9661	●	GF162811.9661	●
9	18	11,9	12	80	20,5	45	4	GF162121.9662	●	GF162421.9662	●	GF162721.9662	●
21	16	11,9	12	80	21,4	45	4	GF162121.9663	●	GF162421.9663	●	GF162721.9663	●

Einsatzgebiete – Material
Applications – material

P 1.1-3.1 M 1.1-2.1 K 1.1-4.2
N 1.1-2.7 N 3.1-5.2 S 1.1-2, 2.1

Nenngröße Nom. size Ø D ¹⁾	P Gg/1" (tpi)	Ø d ₁ mm	Ø d ₂	l ₁	l ₂	l ₃	Z						
								GF-VHM R30-IKZ-HB TICN	GF-VHM R30-IKZ-HE TICN	GF-VHM R30-IKZ-HA TICN			
Pg 7	20	9,9	10	70	17,1	40	4	GF162216.9661	●	GF162516.9661	●	GF162816.9661	●
9	18	11,9	12	80	20,5	45	4	GF162126.9662	●	GF162426.9662	●	GF162726.9662	●
21	16	11,9	12	80	21,4	45	4	GF162126.9663	●	GF162426.9663	●	GF162726.9663	●

¹⁾ Durchmesser bezogen auf Rohr-Innengewinde bzw. Rohr-Außengewinde
Diameter related to internal pipe thread resp. external pipe thread

- Product Finder
- v_c / f_z
- M
- MF
- UNC UN, UNS
- UNF UNEF
- G, Rp
- NPT, NPTF Rc, W
- BSW, BSF
- Pg
- EG (STI) SELF-LOCK
- Tr
- Zubehör Accessories
- Tech. Info
- BGF
- ZBGF
- GSF
- GF
- GF-KEG
- ZGF
- ZIRK-GF
- Gigant
- MoSys



Product Finder

 v_c / f_z

M

MF

 UNC
UN, UNS

 UNF
UNEF

G, Rp

 NPT, NPTF
Rc, W

BSW, BSF

Pg

 EG (STI)
SELF-LOCK

Tr

 Zubehör
Accessories

Tech. Info

BGF

ZBGF

GSF

GF

GF-KEG

ZGF

ZIRK-GF

Gigant

MoSys

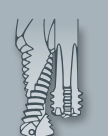

LK-M

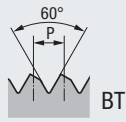

EMUGE-Norm · EMUGE Standard

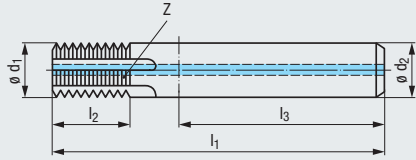
Für Innengewinde
For internal threads

VHM
RH + LH
Z4 - Z5

DIN 6535

 $\varnothing D$

 Einsatzgebiete – Material
Applications – material

» 328

P 1.1-5.1	K 1.1-4.2	N 1.1-5, 2.1-6
N 3.1-2	N 4.1-2, 5.2	S 1.1-3

GF-VHM
IKZ-HB
GF-VHM
IKZ-HE
GF-VHM
IKZ-HA

P mm	$\varnothing D_{min.}$ mm	$\varnothing d_1$ mm	$\varnothing d_2$	l_1	l_2	l_3	Z	GF-VHM IKZ-HB	GF-VHM IKZ-HE	GF-VHM IKZ-HA
1	14	9,9	10	70	16,4	40	4	GF163211.9757	● GF163511.9757	● GF163811.9757
1	16	11,9	12	80	20,4	45	4	GF163121.9757	● GF163421.9757	● GF163721.9757
1,5	14	9,9	10	70	17	40	4	GF163211.9664	● GF163511.9664	● GF163811.9664
1,5	16	11,9	12	80	21,5	45	4	GF163121.9664	● GF163421.9664	● GF163721.9664
2	22	15,9	16	90	26,7	48	5	GF163131.9705	● GF163431.9705	● GF163731.9705
3	30	19,9	20	105	34,1	50	5	GF163151.9767	● GF163451.9767	● GF163751.9767

TICN

 Einsatzgebiete – Material
Applications – material

» 328

P 1.1-5.1	M 1.1-4.1	K 1.1-4.2
N 1.1-5.2	S 1.1-2.6	H 1.1-2

GF-VHM
IKZ-HB
TICN
GF-VHM
IKZ-HE
TICN
GF-VHM
IKZ-HA
TICN

P mm	$\varnothing D_{min.}$ mm	$\varnothing d_1$ mm	$\varnothing d_2$	l_1	l_2	l_3	Z	GF-VHM IKZ-HB TICN	GF-VHM IKZ-HE TICN	GF-VHM IKZ-HA TICN
1	14	9,9	10	70	16,4	40	4	GF163216.9757	● GF163516.9757	● GF163816.9757
1	16	11,9	12	80	20,4	45	4	GF163126.9757	● GF163426.9757	● GF163726.9757
1,5	14	9,9	10	70	17	40	4	GF163216.9664	● GF163516.9664	● GF163816.9664
1,5	16	11,9	12	80	21,5	45	4	GF163126.9664	● GF163426.9664	● GF163726.9664
2	22	15,9	16	90	26,7	48	5	GF163136.9705	● GF163436.9705	● GF163736.9705
3	30	19,9	20	105	34,1	50	5	GF163156.9767	● GF163456.9767	● GF163756.9767

 Andere Steigungen auf Anfrage
Tools for different thread pitch upon request

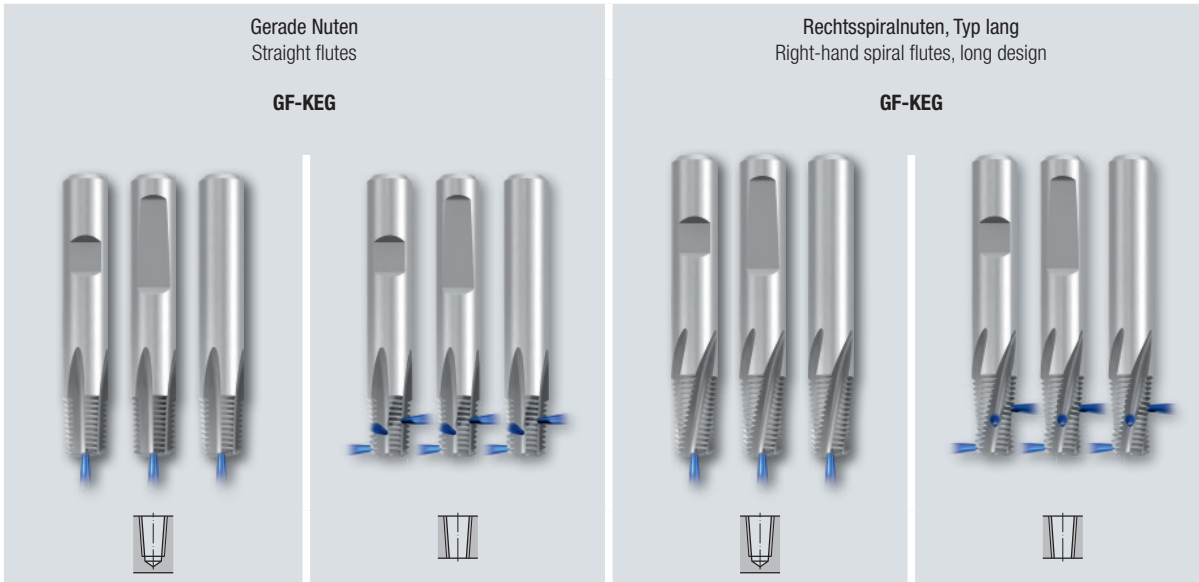

Seite · Page

401	402	403	404	NPT (API-LP)
406	407	408	409	NPTF
411	412			Rc (BSPT)

Product Finder

v_c / f_z

M

MF

UNC
UN, UNS

UNF
UNEF

G, Rp

NPT, NPTF
Rc, W

BSW, BSF

Pg

EG (STI)
SELF-LOCK

Tr

Zubehör
Accessories

Tech. Info

BGF

ZBGF

GSF

GF

GF-KEG

ZGF

ZIRK-GF

Gigant

MoSys



Mögliche Modifikationen · Possible modifications



Stirrfase ohne/mit Stirnschnitt
Face chamfer with/without cutting face



AZR/AZ (ausgesetzte Zähne)
AZR/AZ (alternating teeth)



Unvollständigen Gang entfernen
Remove incomplete thread



IKZN (innere Kühlschmierstoff-Zufuhr mit Austritt in den Nuten)
IKZN (internal coolant supply exiting in the flutes)



Halsfreischliff
Recessed neck



Schaftkühlruten
Coolant grooves along the shank

Eine Beschreibung dieser Modifikationsmöglichkeiten finden Sie auf Seite 456 - 457
For a description of these modifications, see pages 456 - 457

Gewindefräszyklus · Thread milling cycle

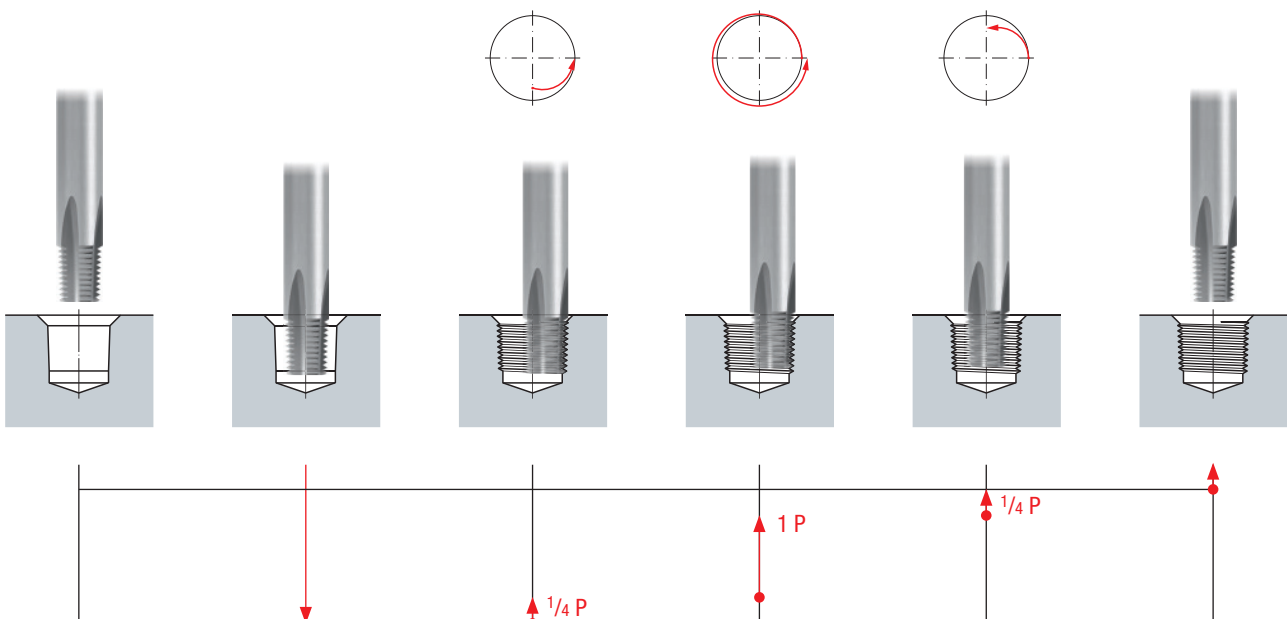

Product Finder

v_c / f_z

M

MF

UNC
UN, UNS

UNF
UNEF

G, Rp

NPT, NPTF
Rc, W

BSW, BSF

Pg

EG (STI)
SELF-LOCK

Tr

Zubehör
Accessories

Tech. Info

BGF

ZBGF

GSF

GF

GF-KEG

ZGF

ZIRK-GF

Gigant

MoSys

NPT



ANSI/ASME B1.20.1

a) Zylindrisch vorarbeiten
Cylindrical preparation of thread hole

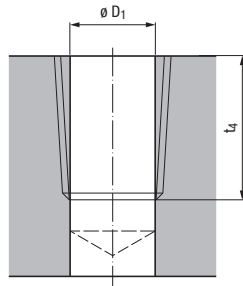

EMUGE NPT-Gewidefräser sind für die Lochformen a) und b) geeignet.
EMUGE NPT thread milling cutters are suited for the hole forms a) and b).

Nenngröße Nom. size D	P Gg/1" (tpi)	$\varnothing D_1$	t_4
1/16	27	6,15	8,30
1/8	27	8,50	8,30
1/4	18	11,00	12,15
3/8	18	14,40	12,45
1/2	14	17,80	16,30
3/4	14	23,15	16,30
1"	11 1/2	29,05	19,55
1 1/4	11 1/2	37,80	20,05
1 1/2	11 1/2	43,85	20,05
2"	11 1/2	55,85	20,45

b) Kegelig vorarbeiten
Tapered preparation of thread hole

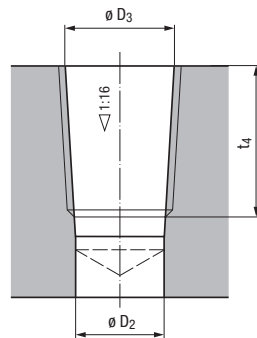

Nenngröße Nom. size D	P Gg/1" (tpi)	$\varnothing D_2$	$\varnothing D_3$ +0,05	t_4
1/16	27	5,95	6,39	8,30
1/8	27	8,30	8,74	8,30
1/4	18	10,75	11,36	12,15
3/8	18	14,15	14,80	12,45
1/2	14	17,45	18,32	16,30
3/4	14	22,80	23,67	16,30
1"	11 1/2	28,65	29,69	19,55
1 1/4	11 1/2	37,35	38,45	20,05
1 1/2	11 1/2	43,45	44,52	20,05
2"	11 1/2	55,45	56,56	20,45

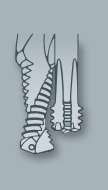

NPT



ANSI/ASME B1.20.1

Für kegeliges Innengewinde
For internal tapered threads

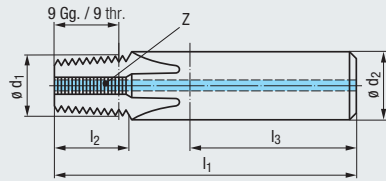

VHM

RH + LH

Z3 - Z5



DIN 6535

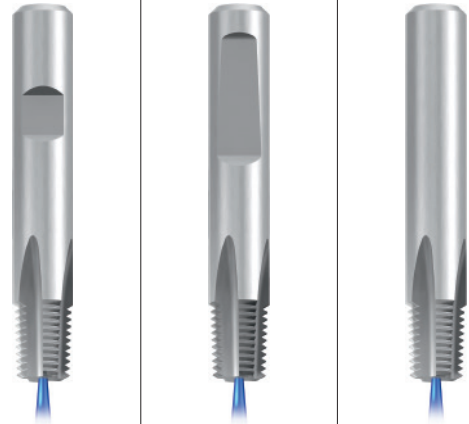

Einsatzgebiete – Material
Applications – material

P 1.1-5.1 K 1.1-4.2 N 1.1-5, 2.1-6
N 3.1-2 N 4.1-2, 5.2 S 1.1-3

Nenngröße Nom. size	P	l_1	l_2	l_3	$\varnothing d_1$	$\varnothing d_2$	Z
D	Gg/1" (tpi)						
1/16	27	55	9,88	36	5,9	8	3
1/8	27	55	9,88	36	7,65	8	3
1/4	18	75	14,79	45	10,15	12	4
3/8	18	75	14,78	45	11,15	12	4
1/2 - 3/4	14	80	19,01	48	14,25	16	4
1" - 2"	11 1/2	90	23,14	50	19,6	20	5

GF-KEG-VHM IKZ-HB	GF-KEG-VHM IKZ-HE	GF-KEG-VHM IKZ-HA
GF173101.5763 ●	GF173401.5763 ●	GF173701.5763 ●
GF173101.5764 ●	GF173401.5764 ●	GF173701.5764 ●
GF173111.5765 ●	GF173411.5765 ●	GF173711.5765 ●
GF173111.5766 ●	GF173411.5766 ●	GF173711.5766 ●
GF173131.9678 ●	GF173431.9678 ●	GF173731.9678 ●
GF173151.9679 ●	GF173451.9679 ●	GF173751.9679 ●

TICN



Einsatzgebiete – Material
Applications – material

P 1.1-5.1 M 1.1-4.1 K 1.1-4.2
N 1.1-5.2 S 1.1-2.6 H 1.1-2

Nenngröße Nom. size	P	l_1	l_2	l_3	$\varnothing d_1$	$\varnothing d_2$	Z
D	Gg/1" (tpi)						
1/16	27	55	9,88	36	5,9	8	3
1/8	27	55	9,88	36	7,65	8	3
1/4	18	75	14,79	45	10,15	12	4
3/8	18	75	14,78	45	11,15	12	4
1/2 - 3/4	14	80	19,01	48	14,25	16	4
1" - 2"	11 1/2	90	23,14	50	19,6	20	5

GF-KEG-VHM IKZ-HB TICN	GF-KEG-VHM IKZ-HE TICN	GF-KEG-VHM IKZ-HA TICN
GF173106.5763 ●	GF173406.5763 ●	GF173706.5763 ●
GF173106.5764 ●	GF173406.5764 ●	GF173706.5764 ●
GF173116.5765 ●	GF173416.5765 ●	GF173716.5765 ●
GF173116.5766 ●	GF173416.5766 ●	GF173716.5766 ●
GF173136.9678 ●	GF173436.9678 ●	GF173736.9678 ●
GF173156.9679 ●	GF173456.9679 ●	GF173756.9679 ●

NPT-Fräser werden mit korrigiertem Profil gefertigt
NPT cutters are manufactured with a corrected profile

Anwendungshinweis: Es wird ein NC-Programm für schneckenförmiges Wendelnutfräsen benötigt, da sonst ein Absatz im gefrästen Gewinde entsteht
Application recommendation: You must have an NC programme for spiral-worm keyway milling, otherwise the finished thread will have a stepped profile

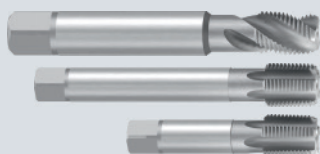

Gewindebohrer für kegelige
Innengewinde siehe Seite 184 - 197

Taps for internal tapered threads,
see page 184 - 197

- Product Finder
- v_c / f_z
- M
- MF
- UNC UN, UNS
- UNF UNEF
- G, Rp
- NPT, NPTF Rc, W
- BSW, BSF
- Pg
- EG (STI) SELF-LOCK
- Tr
- Zubehör Accessories
- Tech. Info
- BGF
- ZBGF
- GSF
- GF
- GF-KEG
- ZGF
- ZIRK-GF
- Gigant
- MoSys



ANSI/ASME B1.20.1

Für kegeliges Innengewinde
For internal tapered threads

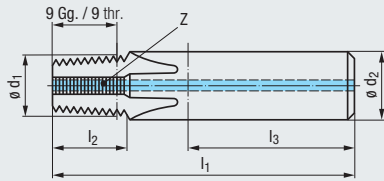

VHM

RH + LH

Z3 - Z5

DIN 6535

HB
HE
HA



new



new



new



Einsatzgebiete – Material Applications – material [» 328](#)

P 1.1-5.1 K 1.1-4.2 N 1.1-5, 2.1-6
N 3.1-2 N 4.1-2, 5.2 S 1.1-3

Nenngröße

Nom. size

D	P Gg/1" (tpi)	l_1	l_2	l_3	$\varnothing d_1$	$\varnothing d_2$	Z
1/16	27	55	9,88	36	5,9	8	3
1/8	27	55	9,88	36	7,65	8	3
1/4	18	75	14,79	45	10,15	12	4
3/8	18	75	14,78	45	11,15	12	4
1/2 - 3/4	14	80	19,01	48	14,25	16	4
1" - 2"	11 1/2	90	23,14	50	19,6	20	5

GF-KEG-VHM
IKZN-HB

GF-KEG-VHM
IKZN-HE

GF-KEG-VHM
IKZN-HA

GF193101.5763	●	GF193401.5763	●	GF193701.5763	●
GF193101.5764	●	GF193401.5764	●	GF193701.5764	●
GF193111.5765	●	GF193411.5765	●	GF193711.5765	●
GF193111.5766	●	GF193411.5766	●	GF193711.5766	●
GF193131.9678	●	GF193431.9678	●	GF193731.9678	●
GF193151.9679	●	GF193451.9679	●	GF193751.9679	●

TICN

new



new



new



Einsatzgebiete – Material Applications – material [» 328](#)

P 1.1-5.1 M 1.1-4.1 K 1.1-4.2
N 1.1-5.2 S 1.1-2.6 H 1.1-2

Nenngröße

Nom. size

D	P Gg/1" (tpi)	l_1	l_2	l_3	$\varnothing d_1$	$\varnothing d_2$	Z
1/16	27	55	9,88	36	5,9	8	3
1/8	27	55	9,88	36	7,65	8	3
1/4	18	75	14,79	45	10,15	12	4
3/8	18	75	14,78	45	11,15	12	4
1/2 - 3/4	14	80	19,01	48	14,25	16	4
1" - 2"	11 1/2	90	23,14	50	19,6	20	5

GF-KEG-VHM
IKZN-HB
TICN

GF-KEG-VHM
IKZN-HE
TICN

GF-KEG-VHM
IKZN-HA
TICN

GF193106.5763	●	GF193406.5763	●	GF193706.5763	●
GF193106.5764	●	GF193406.5764	●	GF193706.5764	●
GF193116.5765	●	GF193416.5765	●	GF193716.5765	●
GF193116.5766	●	GF193416.5766	●	GF193716.5766	●
GF193136.9678	●	GF193436.9678	●	GF193736.9678	●
GF193156.9679	●	GF193456.9679	●	GF193756.9679	●

NPT-Fräser werden mit korrigiertem Profil gefertigt
NPT cutters are manufactured with a corrected profile

Anwendungshinweis: Es wird ein NC-Programm für schneckenförmiges Wendelnutfräsen benötigt, da sonst ein Absatz im gefrästen Gewinde entsteht
Application recommendation: You must have an NC programme for spiral-worm keyway milling, otherwise the finished thread will have a stepped profile

NPT (API-LP)

ANSI/ASME B1.20.1

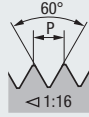

VHM

R15

RH + LH

Z3 - Z5



DIN 6535



Für kegeliges Innengewinde
For internal tapered threads

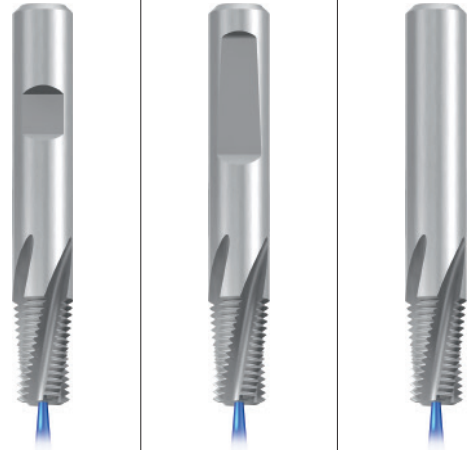
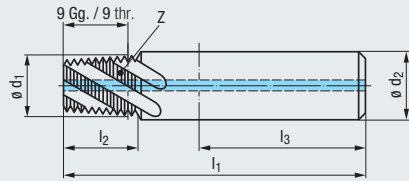

Einsatzgebiete – Material
Applications – material

P 1.1-5.1 K 1.1-4.2 N 1.1-5, 2.1-6
N 3.1-2 N 4.1-2, 5.2 S 1.1-3

Nenngröße Nom. size		P	l_1	l_2	l_3	$\varnothing d_1$	$\varnothing d_2$	Z	GF-KEG-VHM R15-Ig-IKZ-HB	GF-KEG-VHM R15-Ig-IKZ-HE	GF-KEG-VHM R15-Ig-IKZ-HA
D	Gg/1" (tpi)										
1/16	27	60	13,63	36	5,9	8	3	GF175301.5763	● GF175601.5763	● GF175901.5763	●
1/8	27	60	13,63	36	7,65	8	3	GF175301.5764	● GF175601.5764	● GF175901.5764	●
1/4	18	80	20,44	45	10,15	12	4	GF175311.5765	● GF175611.5765	● GF175911.5765	●
3/8	18	80	20,43	45	11,15	12	4	GF175311.5766	● GF175611.5766	● GF175911.5766	●
1/2 - 3/4	14	85	26,27	48	14,25	16	4	GF175331.9678	● GF175631.9678	● GF175931.9678	●
1" - 2"	11 1/2	95	31,98	50	19,6	20	5	GF175351.9679	● GF175651.9679	● GF175951.9679	●

TICN



Einsatzgebiete – Material
Applications – material

P 1.1-5.1 M 1.1-4.1 K 1.1-4.2
N 1.1-5.2 S 1.1-2.6 H 1.1-2

Nenngröße Nom. size		P	l_1	l_2	l_3	$\varnothing d_1$	$\varnothing d_2$	Z	GF-KEG-VHM R15-Ig-IKZ-HB TICN	GF-KEG-VHM R15-Ig-IKZ-HE TICN	GF-KEG-VHM R15-Ig-IKZ-HA TICN
D	Gg/1" (tpi)										
1/16	27	60	13,63	36	5,9	8	3	GF175306.5763	● GF175606.5763	● GF175906.5763	●
1/8	27	60	13,63	36	7,65	8	3	GF175306.5764	● GF175606.5764	● GF175906.5764	●
1/4	18	80	20,44	45	10,15	12	4	GF175316.5765	● GF175616.5765	● GF175916.5765	●
3/8	18	80	20,43	45	11,15	12	4	GF175316.5766	● GF175616.5766	● GF175916.5766	●
1/2 - 3/4	14	85	26,27	48	14,25	16	4	GF175336.9678	● GF175636.9678	● GF175936.9678	●
1" - 2"	11 1/2	95	31,98	50	19,6	20	5	GF175356.9679	● GF175656.9679	● GF175956.9679	●

NPT/API-LP-Fräser werden mit korrigiertem Profil gefertigt
NPT/API-LP cutters are manufactured with a corrected profile

Anwendungshinweis: Es wird ein NC-Programm für schneckenförmiges Wendelnutfräsen benötigt, da sonst ein Absatz im gefrästen Gewinde entsteht
Application recommendation: You must have an NC programme for spiral-worm keyway milling, otherwise the finished thread will have a stepped profile

- Product Finder
- v_c / f_z
- M
- MF
- UNC UN, UNS
- UNF UNEF
- G, Rp
- NPT NPTF Rc, W
- BSW, BSF
- Pg
- EG (STI) SELF-LOCK
- Tr
- Zubehör Accessories
- Tech. Info
- BGF
- ZBGF
- GSF
- GF
- GF-KEG
- ZGF
- ZIRK-GF
- Gigant
- MoSys



- Product Finder
- v_c / f_z
- M
- MF
- UNC
UN, UNS
- UNF
UNEF
- G, Rp
- NPT, NPTF
Rc, W
- BSW, BSF
- Pg
- EG (STI)
SELF-LOCK
- Tr
- Zubehör
Accessories
- Tech. Info
- BGF
- ZBGF
- GSF
- GF
- GF-KEG
- ZGF
- ZIRK-GF
- Gigant
- MoSys

NPT (API-LP)

ANSI/ASME B1.20.1



Für kegeliges Innengewinde
For internal tapered threads

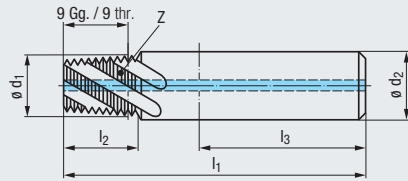

VHM

R15

RH + LH

Z3 - Z5

DIN 6535

HB
HE
HA



new



new



new



Einsatzgebiete – Material
Applications – material

» 328

P 1.1-5.1 K 1.1-4.2 N 1.1-5, 2.1-6
N 3.1-2 N 4.1-2, 5.2 S 1.1-3

Nenngröße
Nom. size

D	P Gg/1" (tpi)	l_1	l_2	l_3	$\varnothing d_1$	$\varnothing d_2$	Z	GF-KEG-VHM R15-Ig- IKZN -HB	GF-KEG-VHM R15-Ig- IKZN -HE	GF-KEG-VHM R15-Ig- IKZN -HA
1/16	27	60	13,63	36	5,9	8	3	GF195301.5763	GF195601.5763	GF195901.5763
1/8	27	60	13,63	36	7,65	8	3	GF195301.5764	GF195601.5764	GF195901.5764
1/4	18	80	20,44	45	10,15	12	4	GF195311.5765	GF195611.5765	GF195911.5765
3/8	18	80	20,43	45	11,15	12	4	GF195311.5766	GF195611.5766	GF195911.5766
1/2 - 3/4	14	85	26,27	48	14,25	16	4	GF195331.9678	GF195631.9678	GF195931.9678
1" - 2"	11 1/2	95	31,98	50	19,6	20	5	GF195351.9679	GF195651.9679	GF195951.9679

TICN

new



new



new



Einsatzgebiete – Material
Applications – material

» 328

P 1.1-5.1 M 1.1-4.1 K 1.1-4.2
N 1.1-5.2 S 1.1-2.6 H 1.1-2

Nenngröße
Nom. size

D	P Gg/1" (tpi)	l_1	l_2	l_3	$\varnothing d_1$	$\varnothing d_2$	Z	GF-KEG-VHM R15-Ig- IKZN -HB TICN	GF-KEG-VHM R15-Ig- IKZN -HE TICN	GF-KEG-VHM R15-Ig- IKZN -HA TICN
1/16	27	60	13,63	36	5,9	8	3	GF195306.5763	GF195606.5763	GF195906.5763
1/8	27	60	13,63	36	7,65	8	3	GF195306.5764	GF195606.5764	GF195906.5764
1/4	18	80	20,44	45	10,15	12	4	GF195316.5765	GF195616.5765	GF195916.5765
3/8	18	80	20,43	45	11,15	12	4	GF195316.5766	GF195616.5766	GF195916.5766
1/2 - 3/4	14	85	26,27	48	14,25	16	4	GF195336.9678	GF195636.9678	GF195936.9678
1" - 2"	11 1/2	95	31,98	50	19,6	20	5	GF195356.9679	GF195656.9679	GF195956.9679

NPT/API-LP-Fräser werden mit korrigiertem Profil gefertigt
NPT/API-LP cutters are manufactured with a corrected profile

Anwendungshinweis: Es wird ein NC-Programm für schneckenförmiges Wendelnutfräsen benötigt, da sonst ein Absatz im gefrästen Gewinde entsteht
Application recommendation: You must have an NC programme for spiral-worm keyway milling, otherwise the finished thread will have a stepped profile

NPTF

ANSI B1.20.3



EMUGE NPTF-Gewidefräser sind für die Lochformen a) und b) geeignet.

EMUGE NPTF thread milling cutters are suited for the hole forms a) and b).

a) Zylindrisch vorarbeiten

Cylindrical preparation of thread hole

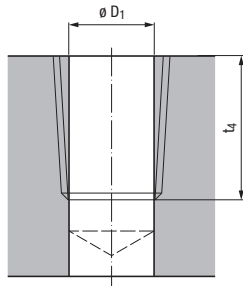

Nenngröße Nom. size D	P Gg/1" (tpi)	$\varnothing D_1$	t_4
1/16	27	6,10	8,30
1/8	27	8,45	8,30
1/4	18	10,90	12,15
3/8	18	14,30	12,45
1/2	14	17,60	16,30
3/4	14	23,00	16,30
1"	11 1/2	28,75	19,55
1 1/4	11 1/2	37,50	20,05
1 1/2	11 1/2	43,75	20,05
2"	11 1/2	55,75	20,45

b) Kegelig vorarbeiten

Tapered preparation of thread hole

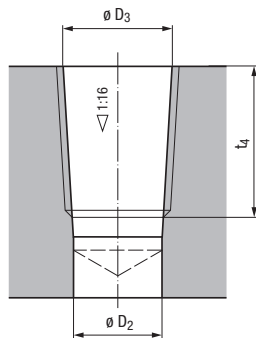

Nenngröße Nom. size D	P Gg/1" (tpi)	$\varnothing D_2$	$\varnothing D_3$ +0,05	t_4
1/16	27	5,95	6,41	8,30
1/8	27	8,30	8,76	8,30
1/4	18	10,75	11,40	12,15
3/8	18	14,15	14,84	12,45
1/2	14	17,45	18,33	16,30
3/4	14	22,80	23,68	16,30
1"	11 1/2	28,65	29,72	19,55
1 1/4	11 1/2	37,35	38,48	20,05
1 1/2	11 1/2	43,45	44,55	20,05
2"	11 1/2	55,45	56,59	20,45

Product Finder

v_c / f_z

M

MF

UNC
UN, UNS

UNF
UNEF

G, Rp

NPT, NPTF
Rc, W

BSW, BSF

Pg

EG (STI)
SELF-LOCK

Tr

Zubehör
Accessories

Tech. Info

BGF

ZBGF

GSF

GF

GF-KEG

ZGF

ZIRK-GF

Gigant

MoSys



- Product Finder
- v_c / f_z
- M
- MF
- UNC
UN, UNS
- UNF
UNEF
- G, Rp
- NPT NPTF
Rc, W
- BSW, BSF
- Pg
- EG (STI)
SELF-LOCK
- Tr
- Zubehör
Accessories
- Tech. Info
- BGF
- ZBGF
- GSF
- GF
- GF-KEG
- ZGF
- ZIRK-GF
- Gigant
- MoSys

NPTF



ANSI B1.20.3

Für kegeliges Innengewinde
For internal tapered threads

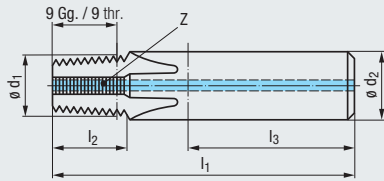

VHM

RH + LH

Z3 - Z5

DIN 6535

HB
HE
HA



Einsatzgebiete – Material
Applications – material

» 328

P 1.1-5.1 K 1.1-4.2 N 1.1-5, 2.1-6
N 3.1-2 N 4.1-2, 5.2 S 1.1-3

Nenngröße
Nom. size

D	P Gg/1" (tpi)	l_1	l_2	l_3	$\varnothing d_1$	$\varnothing d_2$	Z
1/16	27	55	9,84	36	5,9	8	3
1/8	27	55	9,83	36	7,65	8	3
1/4	18	75	14,77	45	10,15	12	4
3/8	18	75	14,76	45	11,15	12	4
1/2	14	80	19	48	14,25	16	4
3/4	14	80	19	48	14,25	16	4
1" - 2"	11 1/2	90	23,13	50	19,6	20	5

GF-KEG-VHM
IKZ-HB

GF-KEG-VHM
IKZ-HE

GF-KEG-VHM
IKZ-HA

GF173101.5782	●	GF173401.5782	●	GF173701.5782	●
GF173101.5783	●	GF173401.5783	●	GF173701.5783	●
GF173111.5784	●	GF173411.5784	●	GF173711.5784	●
GF173111.5785	●	GF173411.5785	●	GF173711.5785	●
GF173131.5786	●	GF173431.5786	●	GF173731.5786	●
GF173131.5787	●	GF173431.5787	●	GF173731.5787	●
GF173151.9684	●	GF173451.9684	●	GF173751.9684	●

TICN



Einsatzgebiete – Material
Applications – material

» 328

P 1.1-5.1 M 1.1-4.1 K 1.1-4.2
N 1.1-5.2 S 1.1-2.6 H 1.1-2

Nenngröße
Nom. size

D	P Gg/1" (tpi)	l_1	l_2	l_3	$\varnothing d_1$	$\varnothing d_2$	Z
1/16	27	55	9,84	36	5,9	8	3
1/8	27	55	9,83	36	7,65	8	3
1/4	18	75	14,77	45	10,15	12	4
3/8	18	75	14,76	45	11,15	12	4
1/2	14	80	19	48	14,25	16	4
3/4	14	80	19	48	14,25	16	4
1" - 2"	11 1/2	90	23,13	50	19,6	20	5

GF-KEG-VHM
IKZ-HB
TICN

GF-KEG-VHM
IKZ-HE
TICN

GF-KEG-VHM
IKZ-HA
TICN

GF173106.5782	●	GF173406.5782	●	GF173706.5782	●
GF173106.5783	●	GF173406.5783	●	GF173706.5783	●
GF173116.5784	●	GF173416.5784	●	GF173716.5784	●
GF173116.5785	●	GF173416.5785	●	GF173716.5785	●
GF173136.5786	●	GF173436.5786	●	GF173736.5786	●
GF173136.5787	●	GF173436.5787	●	GF173736.5787	●
GF173156.9684	●	GF173456.9684	●	GF173756.9684	●

NPTF-Fräser werden mit korrigiertem Profil gefertigt
NPTF cutters are manufactured with a corrected profile

Anwendungshinweis: Es wird ein NC-Programm für schneckenförmiges Wendelnutfräsen benötigt, da sonst ein Absatz im gefrästen Gewinde entsteht
Application recommendation: You must have an NC programme for spiral-worm keyway milling, otherwise the finished thread will have a stepped profile

NPTF

ANSI B1.20.3



Für kegeliges Innengewinde
For internal tapered threads

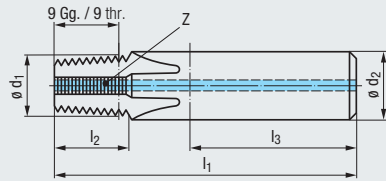

VHM

RH + LH

Z3 - Z5



DIN 6535



new



new



new



Einsatzgebiete – Material
Applications – material

P 1.1-5.1 K 1.1-4.2 N 1.1-5, 2.1-6
N 3.1-2 N 4.1-2, 5.2 S 1.1-3

Nenngröße Nom. size	P	l_1	l_2	l_3	$\varnothing d_1$	$\varnothing d_2$	Z
D	Gg/1" (tpi)						
1/16	27	55	9,84	36	5,9	8	3
1/8	27	55	9,83	36	7,65	8	3
1/4	18	75	14,77	45	10,15	12	4
3/8	18	75	14,76	45	11,15	12	4
1/2	14	80	19	48	14,25	16	4
3/4	14	80	19	48	14,25	16	4
1" - 2"	11 1/2	90	23,13	50	19,6	20	5

GF-KEG-VHM IKZN-HB	GF-KEG-VHM IKZN-HE	GF-KEG-VHM IKZN-HA
GF193101.5782 ●	GF193401.5782 ●	GF193701.5782 ●
GF193101.5783 ●	GF193401.5783 ●	GF193701.5783 ●
GF193111.5784 ●	GF193411.5784 ●	GF193711.5784 ●
GF193111.5785 ●	GF193411.5785 ●	GF193711.5785 ●
GF193131.5786 ●	GF193431.5786 ●	GF193731.5786 ●
GF193131.5787 ●	GF193431.5787 ●	GF193731.5787 ●
GF193151.9684 ●	GF193451.9684 ●	GF193751.9684 ●

TICN

new



new



new



Einsatzgebiete – Material
Applications – material

P 1.1-5.1 M 1.1-4.1 K 1.1-4.2
N 1.1-5.2 S 1.1-2.6 H 1.1-2

Nenngröße Nom. size	P	l_1	l_2	l_3	$\varnothing d_1$	$\varnothing d_2$	Z
D	Gg/1" (tpi)						
1/16	27	55	9,84	36	5,9	8	3
1/8	27	55	9,83	36	7,65	8	3
1/4	18	75	14,77	45	10,15	12	4
3/8	18	75	14,76	45	11,15	12	4
1/2	14	80	19	48	14,25	16	4
3/4	14	80	19	48	14,25	16	4
1" - 2"	11 1/2	90	23,13	50	19,6	20	5

GF-KEG-VHM IKZN-HB TICN	GF-KEG-VHM IKZN-HE TICN	GF-KEG-VHM IKZN-HA TICN
GF193106.5782 ●	GF193406.5782 ●	GF193706.5782 ●
GF193106.5783 ●	GF193406.5783 ●	GF193706.5783 ●
GF193116.5784 ●	GF193416.5784 ●	GF193716.5784 ●
GF193116.5785 ●	GF193416.5785 ●	GF193716.5785 ●
GF193136.5786 ●	GF193436.5786 ●	GF193736.5786 ●
GF193136.5787 ●	GF193436.5787 ●	GF193736.5787 ●
GF193156.9684 ●	GF193456.9684 ●	GF193756.9684 ●

NPTF-Fräser werden mit korrigiertem Profil gefertigt
NPTF cutters are manufactured with a corrected profile

Anwendungshinweis: Es wird ein NC-Programm für schneckenförmiges Wendelnutfräsen benötigt, da sonst ein Absatz im gefrästen Gewinde entsteht
Application recommendation: You must have an NC programme for spiral-worm keyway milling, otherwise the finished thread will have a stepped profile

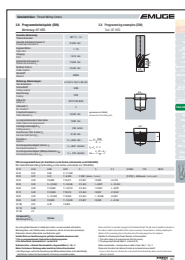

Programmierbeispiel für kegelige
Gewindefräser Typ GF-KEG
siehe Seite 467

Programming example for tapered
thread milling cutters type GF-KEG,
see page 467

- Product Finder
- v_c / f_z
- M
- MF
- UNC
UN, UNS
- UNF
UNEF
- G, Rp
- NPT NPTF
Rc, W
- BSW, BSF
- Pg
- EG (STI)
SELF-LOCK
- Tr
- Zubehör
Accessories
- Tech. Info
- BGF
- ZBGF
- GSF
- GF
- GF-KEG
- ZGF
- ZIRK-GF
- Gigant
- MoSys

NPTF



ANSI B1.20.3

Für kegeliges Innengewinde
For internal tapered threads

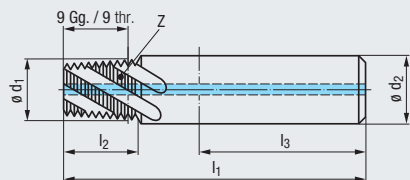

VHM

R15

RH + LH

Z3 - Z5

DIN 6535



Einsatzgebiete – Material
Applications – material

» 328

P 1.1-5.1 K 1.1-4.2 N 1.1-5, 2.1-6
N 3.1-2 N 4.1-2, 5.2 S 1.1-3

Nenngröße

Nom. size

D	P Gg/1" (tpi)	l_1	l_2	l_3	$\varnothing d_1$	$\varnothing d_2$	Z
1/16	27	60	13,6	36	5,9	8	3
1/8	27	60	13,6	36	7,65	8	3
1/4	18	80	20,41	45	10,15	12	4
3/8	18	80	20,4	45	11,15	12	4
1/2	14	85	26,25	48	14,25	16	4
3/4	14	85	26,25	48	14,25	16	4
1" - 2"	11 1/2	95	31,96	50	19,6	20	5

GF-KEG-VHM
R15-Ig-IKZ-HB

GF-KEG-VHM
R15-Ig-IKZ-HE

GF-KEG-VHM
R15-Ig-IKZ-HA

GF175301.5782	●	GF175601.5782	●	GF175901.5782	●
GF175301.5783	●	GF175601.5783	●	GF175901.5783	●
GF175311.5784	●	GF175611.5784	●	GF175911.5784	●
GF175311.5785	●	GF175611.5785	●	GF175911.5785	●
GF175331.5786	●	GF175631.5786	●	GF175931.5786	●
GF175331.5787	●	GF175631.5787	●	GF175931.5787	●
GF175351.9684	●	GF175651.9684	●	GF175951.9684	●

TICN



Einsatzgebiete – Material
Applications – material

» 328

P 1.1-5.1 M 1.1-4.1 K 1.1-4.2
N 1.1-5.2 S 1.1-2.6 H 1.1-2

Nenngröße

Nom. size

D	P Gg/1" (tpi)	l_1	l_2	l_3	$\varnothing d_1$	$\varnothing d_2$	Z
1/16	27	60	13,6	36	5,9	8	3
1/8	27	60	13,6	36	7,65	8	3
1/4	18	80	20,41	45	10,15	12	4
3/8	18	80	20,4	45	11,15	12	4
1/2	14	85	26,25	48	14,25	16	4
3/4	14	85	26,25	48	14,25	16	4
1" - 2"	11 1/2	95	31,96	50	19,6	20	5

GF-KEG-VHM
R15-Ig-IKZ-HB
TICN

GF-KEG-VHM
R15-Ig-IKZ-HE
TICN

GF-KEG-VHM
R15-Ig-IKZ-HA
TICN

GF175306.5782	●	GF175606.5782	●	GF175906.5782	●
GF175306.5783	●	GF175606.5783	●	GF175906.5783	●
GF175316.5784	●	GF175616.5784	●	GF175916.5784	●
GF175316.5785	●	GF175616.5785	●	GF175916.5785	●
GF175336.5786	●	GF175636.5786	●	GF175936.5786	●
GF175336.5787	●	GF175636.5787	●	GF175936.5787	●
GF175356.9684	●	GF175656.9684	●	GF175956.9684	●

NPTF-Fräser werden mit korrigiertem Profil gefertigt
NPTF cutters are manufactured with a corrected profile

Anwendungshinweis: Es wird ein NC-Programm für schneckenförmiges Wendelnutfräsen benötigt, da sonst ein Absatz im gefrästen Gewinde entsteht
Application recommendation: You must have an NC programme for spiral-worm keyway milling, otherwise the finished thread will have a stepped profile

NPTF

ANSI B1.20.3



Für kegeliges Innengewinde
For internal tapered threads

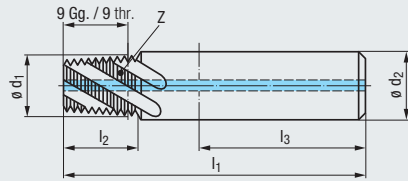

VHM

R15 **RH + LH**

Z3 - Z5 **DIN 6535**
 HB
 HE
 HA

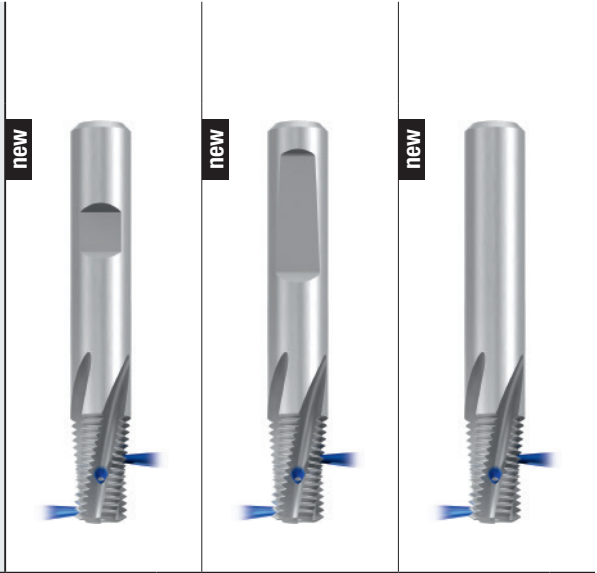

Einsatzgebiete – Material ▶▶ 328
Applications – material

P 1.1-5.1 **K** 1.1-4.2 **N** 1.1-5, 2.1-6
N 3.1-2 **N** 4.1-2, 5.2 **S** 1.1-3

Nenngröße Nom. size								GF-KEG-VHM R15-Ig-IKZN-HB	GF-KEG-VHM R15-Ig-IKZN-HE	GF-KEG-VHM R15-Ig-IKZN-HA
D	P Gg/1" (tpi)	l_1	l_2	l_3	$\varnothing d_1$	$\varnothing d_2$	Z			
1/16	27	60	13,6	36	5,9	8	3	GF195301.5782 ●	GF195601.5782 ●	GF195901.5782 ●
1/8	27	60	13,6	36	7,65	8	GF195301.5783 ●	GF195601.5783 ●	GF195901.5783 ●	
1/4	18	80	20,41	45	10,15	12	GF195311.5784 ●	GF195611.5784 ●	GF195911.5784 ●	
3/8	18	80	20,4	45	11,15	12	GF195311.5785 ●	GF195611.5785 ●	GF195911.5785 ●	
1/2	14	85	26,25	48	14,25	16	GF195331.5786 ●	GF195631.5786 ●	GF195931.5786 ●	
3/4	14	85	26,25	48	14,25	16	GF195331.5787 ●	GF195631.5787 ●	GF195931.5787 ●	
1" - 2"	11 1/2	95	31,96	50	19,6	20	GF195351.9684 ●	GF195651.9684 ●	GF195951.9684 ●	

TICN

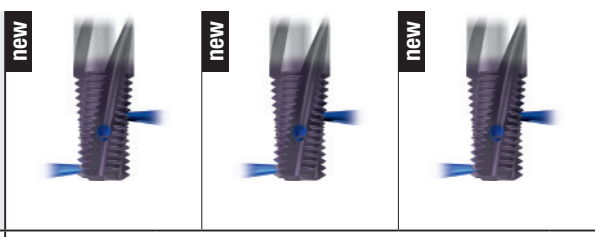

Einsatzgebiete – Material ▶▶ 328
Applications – material

P 1.1-5.1 **M** 1.1-4.1 **K** 1.1-4.2
N 1.1-5.2 **S** 1.1-2.6 **H** 1.1-2

Nenngröße Nom. size								GF-KEG-VHM R15-Ig-IKZN-HB TICN	GF-KEG-VHM R15-Ig-IKZN-HE TICN	GF-KEG-VHM R15-Ig-IKZN-HA TICN
D	P Gg/1" (tpi)	l_1	l_2	l_3	$\varnothing d_1$	$\varnothing d_2$	Z			
1/16	27	60	13,6	36	5,9	8	3	GF195306.5782 ●	GF195606.5782 ●	GF195906.5782 ●
1/8	27	60	13,6	36	7,65	8	3	GF195306.5783 ●	GF195606.5783 ●	GF195906.5783 ●
1/4	18	80	20,41	45	10,15	12	4	GF195316.5784 ●	GF195616.5784 ●	GF195916.5784 ●
3/8	18	80	20,4	45	11,15	12	4	GF195316.5785 ●	GF195616.5785 ●	GF195916.5785 ●
1/2	14	85	26,25	48	14,25	16	4	GF195336.5786 ●	GF195636.5786 ●	GF195936.5786 ●
3/4	14	85	26,25	48	14,25	16	4	GF195336.5787 ●	GF195636.5787 ●	GF195936.5787 ●
1" - 2"	11 1/2	95	31,96	50	19,6	20	5	GF195356.9684 ●	GF195656.9684 ●	GF195956.9684 ●

NPTF-Fräser werden mit korrigiertem Profil gefertigt
NPTF cutters are manufactured with a corrected profile

Anwendungshinweis: Es wird ein NC-Programm für schneckenförmiges Wendelnutfräsen benötigt, da sonst ein Absatz im gefrästen Gewinde entsteht
Application recommendation: You must have an NC programme for spiral-worm keyway milling, otherwise the finished thread will have a stepped profile

Product Finder

v_c / f_z

M

MF

UNC
UN, UNS

UNF
UNEF

G, Rp

NPT, NPTF
Rc, W

BSW, BSF

Pg

EG (STI)
SELF-LOCK

Tr

Zubehör
Accessories

Tech. Info

BGF

ZBGF

GSF

GF

GF-KEG

ZGF

ZIRK-GF

Gigant

MoSys

Product Finder

v_c / f_z

M

MF

UNC
UN, UNS

UNF
UNEF

G, Rp

NPT, NPTF
Rc, W

BSW, BSF

Pg

EG (STI)
SELF-LOCK

Tr

Zubehör
Accessories

Tech. Info

BGF

ZBGF

GSF

GF

GF-KEG

ZGF

ZIRK-GF

Gigant

MoSys



Rc (BSPT)

DIN EN 10226-2, ISO 7-1



a) Zylindrisch vorarbeiten
Cylindrical preparation of thread hole

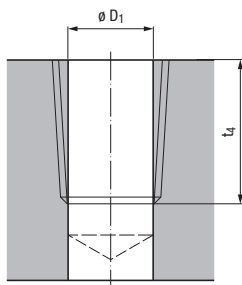

b) Kegelig vorarbeiten
Tapered preparation of thread hole

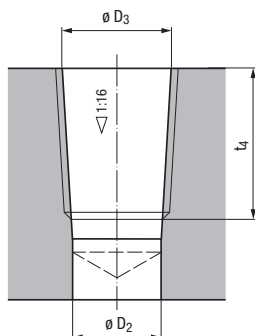

EMUGE Rc-Gewindebohrer sind für die Lochformen a) und b) geeignet. Die Lochform a) kann angewendet werden, wenn keine Dichtprobleme zu befürchten sind.

EMUGE Rc taps are suited for the hole forms a) and b). Hole type a) can be used when there is no reason to worry about sealing problems.

Nenngröße Nom. size D	P Gg/1" (tpi)	$\varnothing D_1$	t_4
Rc 1/16	28	6,15	7,85
1/8	28	8,15	7,85
1/4	19	10,85	11,65
3/8	19	14,3	12,05
1/2	14	17,8	15,9
3/4	14	23,2	16,75
1"	11	29,2	19,65
1 1/4	11	37,8	21,95
1 1/2	11	43,7	21,95
2"	11	55,2	26,25

Nenngröße Nom. size D	P Gg/1" (tpi)	$\varnothing D_2$	$\varnothing D_3$ (JS11)	t_4
Rc 1/16	28	6,1	6,56	7,85
1/8	28	8,1	8,57	7,85
1/4	19	10,75	11,45	11,65
3/8	19	14,25	14,95	12,05
1/2	14	17,7	18,63	15,9
3/4	14	23,1	24,12	16,75
1"	11	29,1	30,29	19,65
1 1/4	11	37,6	38,95	21,95
1 1/2	11	43,5	44,85	21,95
2"	11	55	56,66	26,25

Rc (BSPT)

DIN EN 10226-2, ISO 7-1



VHM

RH + LH

Z3 - Z5



DIN 6535



Für kegeliges Innengewinde
For internal tapered threads

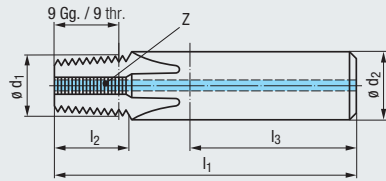

Einsatzgebiete – Material
Applications – material

» 328

Nenngröße

Nom. size

	D	P Gg/1" (tpi)	l ₁	l ₂	l ₃	ø d ₁	ø d ₂	Z
Rc 1/16	28	28	55	8,56	36	5,9	8	3
1/8	28	28	55	8,56	36	7,65	8	3
1/4	19	75	75	13,96	45	10,15	12	4
3/8	19	75	75	13,96	45	11,15	12	4
1/2 - 3/4	14	80	80	19,06	48	14,25	16	4
1" - 2"	11	90	90	24,26	50	19,6	20	5

P 1.1-5.1 K 1.1-4.2 N 1.1-5, 2.1-6
N 3.1-2 N 4.1-2, 5.2 S 1.1-3

GF-KEG-VHM
IKZ-HB

GF-KEG-VHM
IKZ-HE

GF-KEG-VHM
IKZ-HA

GF173101.4114	GF173401.4114	GF173701.4114
GF173101.4115 ●	GF173401.4115 ●	GF173701.4115 ●
GF173111.4116 ●	GF173411.4116 ●	GF173711.4116 ●
GF173111.4117 ●	GF173411.4117 ●	GF173711.4117 ●
GF173131.9561 ●	GF173431.9561 ●	GF173731.9561 ●
GF173151.9562 ●	GF173451.9562 ●	GF173751.9562 ●

TICN

Einsatzgebiete – Material
Applications – material

» 328

Nenngröße

Nom. size

	D	P Gg/1" (tpi)	l ₁	l ₂	l ₃	ø d ₁	ø d ₂	Z
Rc 1/16	28	28	55	8,56	36	5,9	8	3
1/8	28	28	55	8,56	36	7,65	8	3
1/4	19	75	75	13,96	45	10,15	12	4
3/8	19	75	75	13,96	45	11,15	12	4
1/2 - 3/4	14	80	80	19,06	48	14,25	16	4
1" - 2"	11	90	90	24,26	50	19,6	20	5

P 1.1-5.1 M 1.1-4.1 K 1.1-4.2
N 1.1-5.2 S 1.1-2.6 H 1.1-2

GF-KEG-VHM
IKZ-HB
TICN

GF-KEG-VHM
IKZ-HE
TICN

GF-KEG-VHM
IKZ-HA
TICN

GF173106.4114	GF173406.4114	GF173706.4114
GF173106.4115 ●	GF173406.4115 ●	GF173706.4115 ●
GF173116.4116 ●	GF173416.4116 ●	GF173716.4116 ●
GF173116.4117 ●	GF173416.4117 ●	GF173716.4117 ●
GF173136.9561 ●	GF173436.9561 ●	GF173736.9561 ●
GF173156.9562 ●	GF173456.9562 ●	GF173756.9562 ●

Rc-Fräser werden mit korrigiertem Profil gefertigt
Rc cutters are manufactured with a corrected profile

Anwendungshinweis: Es wird ein NC-Programm für schneckenförmiges Wendelnutfräsen benötigt, da sonst ein Absatz im gefrästen Gewinde entsteht
Application recommendation: You must have an NC programme for spiral-worm keyway milling, otherwise the finished thread will have a stepped profile



Schneideisen für kegeliges
Außengewinde siehe Seite 493

Dies for external tapered thread,
see page 493

- Product Finder
- v_c / f_z
- M
- MF
- UNC UN, UNS
- UNF UNEF
- G, Rp
- NPT, NPTF Rc W
- BSW, BSF
- Pg
- EG (STI) SELF-LOCK
- Tr
- Zubehör Accessories
- Tech. Info
- BGF
- ZBGF
- GSF
- GF
- GF-KEG
- ZGF
- ZIRK-GF
- Gigant
- MoSys

RC (BSPT)

DIN EN 10226-2, ISO 7-1



Für kegeliges Innengewinde
For internal tapered threads

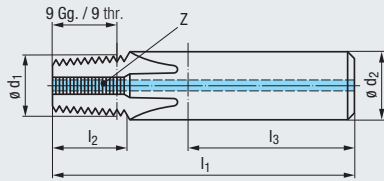

VHM

RH + LH

Z3 - Z5

DIN 6535

HB
HE
HA

new

new

new

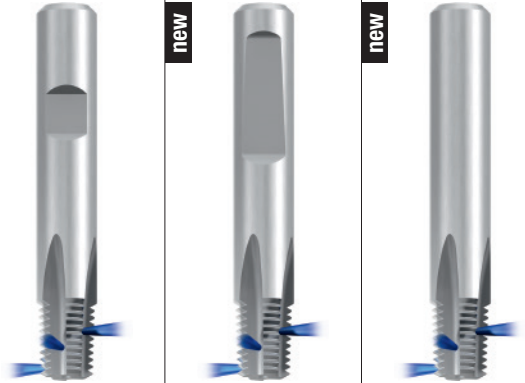

Einsatzgebiete – Material
Applications – material

» 328

P 1.1-5.1 K 1.1-4.2 N 1.1-5, 2.1-6
N 3.1-2 N 4.1-2, 5.2 S 1.1-3

Nenngröße
Nom. size

D	P Gg/1" (tpi)	l ₁	l ₂	l ₃	ø d ₁	ø d ₂	Z	GF-KEG-VHM		
								IKZN-HB	IKZN-HE	IKZN-HA
Rc 1/16	28	55	8,56	36	5,9	8	3	GF193101.4114	GF193401.4114	GF193701.4114
1/8	28	55	8,56	36	7,65	8	3	GF193101.4115	GF193401.4115	GF193701.4115
1/4	19	75	13,96	45	10,15	12	4	GF193111.4116	GF193411.4116	GF193711.4116
3/8	19	75	13,95	45	11,15	12	4	GF193111.4117	GF193411.4117	GF193711.4117
1/2 - 3/4	14	80	19,06	48	14,25	16	4	GF193131.9561	GF193431.9561	GF193731.9561
1" - 2"	11	90	24,26	50	19,6	20	5	GF193151.9562	GF193451.9562	GF193751.9562

TICN

new

new

new



Einsatzgebiete – Material
Applications – material

» 328

P 1.1-5.1 M 1.1-4.1 K 1.1-4.2
N 1.1-5.2 S 1.1-2.6 H 1.1-2

Nenngröße
Nom. size

D	P Gg/1" (tpi)	l ₁	l ₂	l ₃	ø d ₁	ø d ₂	Z	GF-KEG-VHM		
								IKZN-HB TICN	IKZN-HE TICN	IKZN-HA TICN
Rc 1/16	28	55	8,56	36	5,9	8	3	GF193106.4114	GF193406.4114	GF193706.4114
1/8	28	55	8,56	36	7,65	8	3	GF193106.4115	GF193406.4115	GF193706.4115
1/4	19	75	13,96	45	10,15	12	4	GF193116.4116	GF193416.4116	GF193716.4116
3/8	19	75	13,95	45	11,15	12	4	GF193116.4117	GF193416.4117	GF193716.4117
1/2 - 3/4	14	80	19,06	48	14,25	16	4	GF193136.9561	GF193436.9561	GF193736.9561
1" - 2"	11	90	24,26	50	19,6	20	5	GF193156.9562	GF193456.9562	GF193756.9562

Rc-Fräser werden mit korrigiertem Profil gefertigt
Rc cutters are manufactured with a corrected profile

Anwendungshinweis: Es wird ein NC-Programm für schneckenförmiges Wendelnutfräsen benötigt, da sonst ein Absatz im gefrästen Gewinde entsteht
Application recommendation: You must have an NC programme for spiral-worm keyway milling, otherwise the finished thread will have a stepped profile

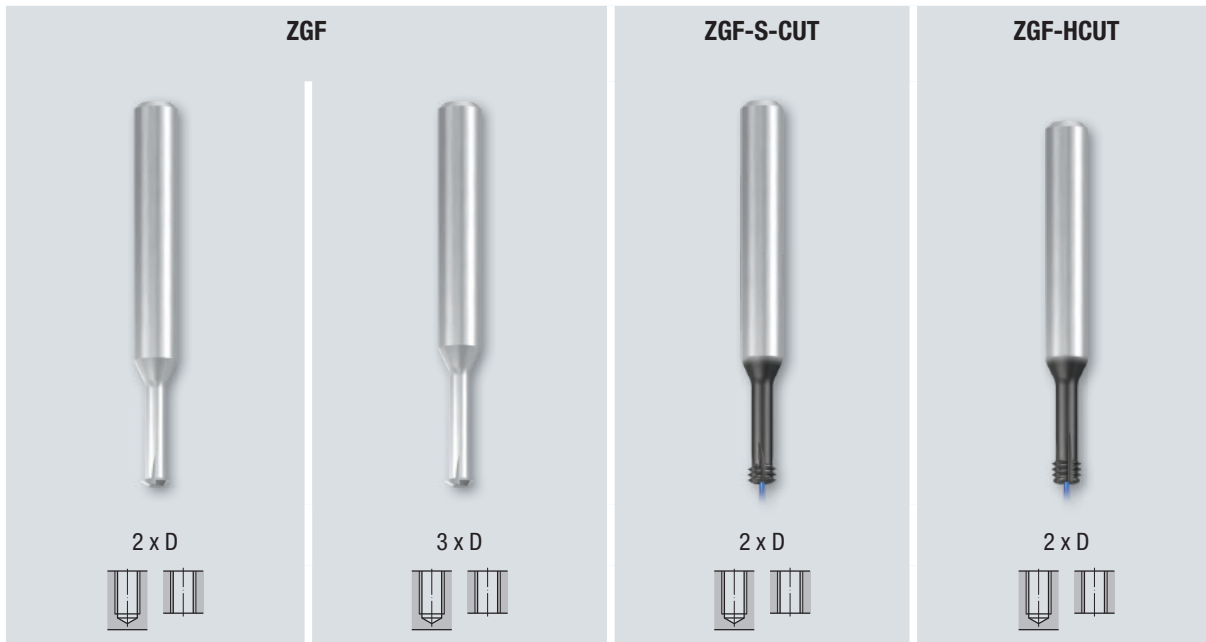

Seite · Page

414	415	416	417	M, MF
418	419	420		UNC
418	419	420		UNF

Product Finder

v_c / f_z

M

MF

UNC
UN, UNS

UNF
UNEF

G, Rp

NPT, NPTF
Rc, W

BSW, BSF

Pg

EG (STI)
SELF-LOCK

Tr

Zubehör
Accessories

Tech. Info

BGF

ZBGF

GSF

GF

GF-KEG

ZGF

ZIRK-GF

Gigant

MoSys



Gewindefräszyklus · Thread milling cycle

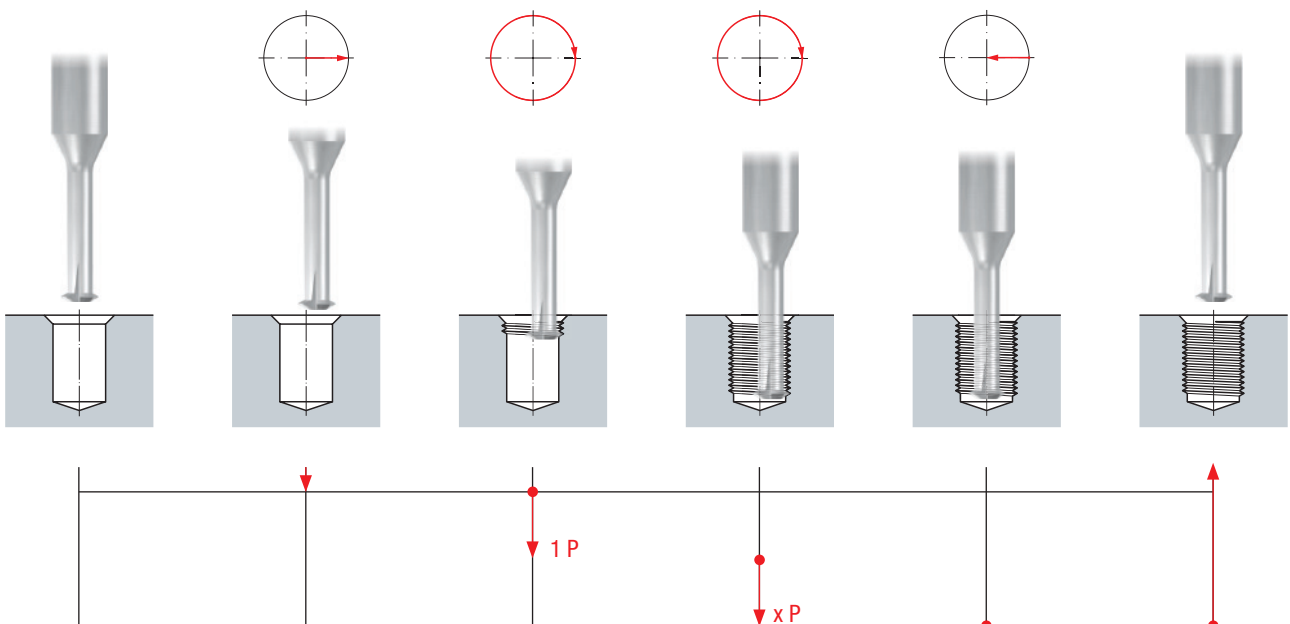

- Product Finder
- v_c / f_z
- M
- MF
- UNC
UN, UNS
- UNF
UNEF
- G, Rp
- NPT, NPTF
Rc, W
- BSW, BSF
- Pg
- EG (STI)
SELF-LOCK
- Tr
- Zubehör
Accessories
- Tech. Info
- BGF
- ZBGF
- GSF
- GF
- GF-KEG
- ZGF
- ZIRK-GF
- Gigant
- MoSys

M, MF

DIN 13

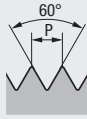

VHM

RH + LH

Z1 - Z5



DIN 6535



Für Innengewinde
For internal threads

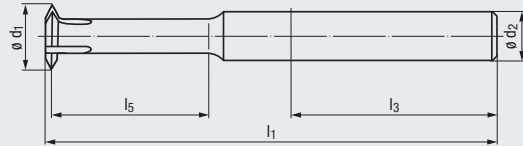

new



2 x D

Gewindetiefe
Thread depth

Einsatzgebiete – Material
Applications – material

P 1.1-5.1 K 1.1-4.2 N 1.1-5, 2.1-6
N 3.1-2 N 4.1-2, 5.2 S 1.1-3

Tech. Info

$\varnothing D$	$P_{max.}$ mm	l_1	l_3	l_5	$\varnothing d_1$	$\varnothing d_2$	Z	ZGF-VHM 2xD HA	ZGF-VHM 2xD HB
M1 - M1,2	0,25	39	28	2,8	0,7	3	1	GF243701.0010	●
M1,4 - M1,8	0,35	39	28	3,5	1,04	3	2	GF253701.0014	●
M2 - M2,3	0,45	39	28	4,8	1,52	3	3	GF253701.0020	●
M2,5 - M3	0,5	39	28	6	1,95	3	3	GF253701.0025	●
M3,5 - M4,5	0,75	42	28	9	2,78	4	3	GF253701.0035	●
M5 - M7	1	55	36	14	4	6	4	GF253701.0050	● GF253101.0050 ●
M8 - M10 ¹⁾	1,5	62	36	19,8	6,5	8	5	GF253701.0080	● GF253101.0080 ●
M12 - M16 ¹⁾	2	78	40	31,8	9,9	10	5	GF253701.0112	● GF253101.0112 ●

Einsatzgebiete – Material
Applications – material

TICN



new



P 1.1-5.1 M 1.1-4.1 K 1.1-4.2
N 1.1-5.2 S 1.1-2.6 H 1.1-2

$\varnothing D$	$P_{max.}$ mm	l_1	l_3	l_5	$\varnothing d_1$	$\varnothing d_2$	Z	ZGF-VHM 2xD HA TICN	ZGF-VHM 2xD HB TICN
M1 - M1,2	0,25	39	28	2,8	0,7	3	1	GF243706.0010	●
M1,4 - M1,8	0,35	39	28	3,5	1,04	3	2	GF253706.0014	●
M2 - M2,3	0,45	39	28	4,8	1,52	3	3	GF253706.0020	●
M2,5 - M3	0,5	39	28	6	1,95	3	3	GF253706.0025	●
M3,5 - M4,5	0,75	42	28	9	2,78	4	3	GF253706.0035	●
M5 - M7	1	55	36	14	4	6	4	GF253706.0050	● GF253106.0050 ●
M8 - M10 ¹⁾	1,5	62	36	19,8	6,5	8	5	GF253706.0080	● GF253106.0080 ●
M12 - M16 ¹⁾	2	78	40	31,8	9,9	10	5	GF253706.0112	● GF253106.0112 ●

¹⁾ Ausführung mit innerer Kühlschmierstoff-Zufuhr IKZ
Design with internal coolant supply IKZ

Teilweise auch für UN-Gewinde verwendbar
Partly suitable also for UN threads

Andere Ausführungen auf Anfrage
Other designs upon request

M, MF

DIN 13

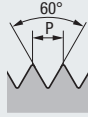

Für Innengewinde
For internal threads

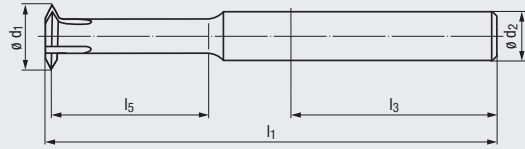

Gewindetiefe
Thread depth

Einsatzgebiete – Material
Applications – material



VHM **new**

RH + LH

Z1 - Z5

DIN 6535

HA HB

ϕD



3 x D

P 1.1-5.1 **K** 1.1-4.2 **N** 1.1-5, 2.1-6
N 3.1-2 **N** 4.1-2, 5.2 **S** 1.1-3

ø D	P _{max.} mm	l ₁	l ₃	l ₅	ø d ₁	ø d ₂	Z	ZGF-VHM 3xD HA		ZGF-VHM 3xD HB	
								●	○	●	○
M1	0,25	39	28	3,1	0,7	3	1	GF273701.0010	●		
M1,6	0,35	39	28	4,95	1,18	3	2	GF273701.0016	●		
M2	0,4	39	28	6,2	1,52	3	3	GF273701.0020	●		
M2,5	0,45	39	28	7,7	1,96	3	3	GF273701.0025	●		
M3	0,5	41	28	9,25	2,4	3	3	GF273701.0030	●		
M4	0,7	44	28	12,35	3,15	4	3	GF273701.0040	●		
M5	0,8	56	36	15,4	4,04	6	4	GF273701.0050	●		
M6	1	59	36	18,5	4,8	6	4	GF273701.0060	●		
M8 ¹⁾	1,25	65	36	24,65	6,5	8	5	GF273701.0080	●		
M10 ¹⁾	1,5	77	40	30,75	8,2	10	5	GF273701.0100	●		
M12 ¹⁾	1,75	82	40	36,85	9,9	10	5	GF273701.0112	●		
M14 ¹⁾	2	94	45	43	11,6	12	5	GF273701.0114	●		
M16 ¹⁾	2	100	45	49	13,6	14	5	GF273701.0116	●		

Einsatzgebiete – Material
Applications – material



TICN **new**

P 1.1-5.1 **M** 1.1-4.1 **K** 1.1-4.2
N 1.1-5.2 **S** 1.1-2.6 **H** 1.1-2

ø D	P _{max.} mm	l ₁	l ₃	l ₅	ø d ₁	ø d ₂	Z	ZGF-VHM 3xD HA TICN		ZGF-VHM 3xD HB TICN	
								●	○	●	○
M1	0,25	39	28	3,1	0,7	3	1	GF273706.0010	●		
M1,6	0,35	39	28	4,95	1,18	3	2	GF273706.0016	●		
M2	0,4	39	28	6,2	1,52	3	3	GF273706.0020	●		
M2,5	0,45	39	28	7,7	1,96	3	3	GF273706.0025	●		
M3	0,5	41	28	9,25	2,4	3	3	GF273706.0030	●		
M4	0,7	44	28	12,35	3,15	4	3	GF273706.0040	●		
M5	0,8	56	36	15,4	4,04	6	4	GF273706.0050	●	GF273106.0050	●
M6	1	59	36	18,5	4,8	6	4	GF273706.0060	●	GF273106.0060	●
M8 ¹⁾	1,25	65	36	24,65	6,5	8	5	GF273706.0080	●	GF273106.0080	●
M10 ¹⁾	1,5	77	40	30,75	8,2	10	5	GF273706.0100	●	GF273106.0100	●
M12 ¹⁾	1,75	82	40	36,85	9,9	10	5	GF273706.0112	●	GF273106.0112	●
M14 ¹⁾	2	94	45	43	11,6	12	5	GF273706.0114	●	GF273106.0114	●
M16 ¹⁾	2	100	45	49	13,6	14	5	GF273706.0116	●	GF273106.0116	●

¹⁾ Ausführung mit innerer Kühlschmierstoff-Zufuhr IKZ
Design with internal coolant supply IKZ

Teilweise auch für UN-Gewinde verwendbar
Partly suitable also for UN threads

Andere Ausführungen auf Anfrage
Other designs upon request

Product Finder

v_c / f_z

M

MF

UNC
UN, UNS

UNF
UNEF

G, Rp

NPT, NPTF
Rc, W

BSW, BSF

Pg

EG (STI)
SELF-LOCK

Tr

Zubehör
Accessories

Tech. Info

BGF

ZBGF

GSF

GF

GF-KEG

ZGF

ZIRK-GF

Gigant

MoSys

- Product Finder
- v_c / f_z
- M
- MF
- UNC
UN, UNS
- UNF
UNEF
- G, Rp
- NPT, NPTF
Rc, W
- BSW, BSF
- Pg
- EG (STI)
SELF-LOCK
- Tr
- Zubehör
Accessories
- Tech. Info
- BGF
- ZBGF
- GSF
- GF
- GF-KEG
- ZGF
- ZIRK-GF
- Gigant
- MoSys

M, MF

DIN 13

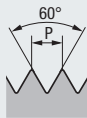

Für Innengewinde
For internal threads

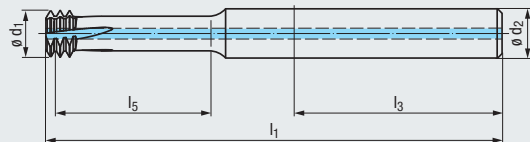

VHM	TIALN T46
RH + LH	LH-rot.
L10	Z4 - Z5
DIN 6535	$\varnothing D$
HA	HB

new



new



Gewindetiefe
Thread depth

2 x D

Einsatzgebiete – Material
Applications – material



P 1.1-5.1	M 1.1-4.1	K 1.1-4.2
N 1.1-5.2	S 1.1-2.6	H 1.1-2

$\varnothing D$	$P_{max.}$ mm	l_1	l_3	l_5	$\varnothing d_1$	$\varnothing d_2$	Z
M 3 ²⁾	0,5	39	28	6,2	2,4	3	4
M 4 ²⁾	0,7	42	28	8,3	3,15	4	4
M 5	0,8	52	36	10,3	4,04	6	4
M 6	1	55	36	12,43	4,8	6	4
M 8	1,25	60	36	16,7	6,5	8	4
M10	1,5	70	40	20,7	8,2	10	5

ZGF-S-CUT-VHM
2xD
IKZ-HA
TIALN-T46

ZGF-S-CUT-VHM
2xD
IKZ-HB
TIALN-T46

GF26A729.0030	●		
GF26A729.0040	●		
GF26A729.0050	●	GF26A129.0050	●
GF26A729.0060	●	GF26A129.0060	●
GF26A729.0080	●	GF26A129.0080	●
GF26A729.0100	●	GF26A129.0100	●

²⁾ Ausführung ohne innerer Kühlschmierstoff-Zufuhr IKZ
Design without internal coolant supply IKZ

Andere Ausführungen auf Anfrage
Other designs upon request

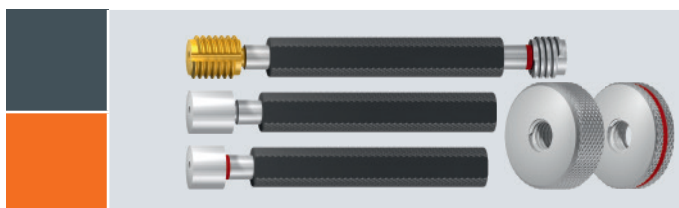

Gewindelehren
siehe Seite 581 - 654

Thread gauges,
see page 581 - 654

M, MF

DIN 13

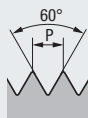

Für Innengewinde
For internal threads

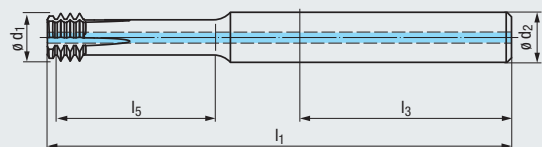

VHM **TIALN T46** **new**

RH + LH **LH-rot.**

Z4 - Z5

DIN 6535

HA HB



new

Gewindetiefe
Thread depth

2 x D

Einsatzgebiete – Material
Applications – material **328**

H **1.1-5**

ø D	P _{max.} mm	l ₁	l ₃	l ₅	ø d ₁	ø d ₂	Z	ZGF-HCUT-VHM 2xD IKZ-HA TIALN-T46		ZGF-HCUT-VHM 2xD IKZ-HB TIALN-T46	
								●	●	●	●
M 3 ²⁾	0,5	51	36	6,25	2,4	6	4	●	●	●	●
M 4 ²⁾	0,7	51	36	8,35	3,15	6	4	●	●	●	●
M 5	0,8	52	36	10,4	4,04	6	4	●	●	●	●
M 6	1	55	36	12,3	4,8	6	4	●	●	●	●
M 8	1,25	60	36	16,6	6,5	8	4	●	●	●	●
M10	1,5	70	40	20,75	8,2	10	5	●	●	●	●
M12	1,75	74	40	24,85	9,9	10	5	●	●	●	●
M14	2	85	45	29	11,6	12	5	●	●	●	●
M16	2	90	45	33	13,6	14	5	●	●	●	●

²⁾ Ausführung ohne innerer Kühlschmierstoff-Zufuhr IKZ
Design without internal coolant supply IKZ

Andere Ausführungen auf Anfrage
Other designs upon request

Product Finder

v_c / f_z

M

MF

UNC UN, UNS

UNF UNEF

G, Rp

NPT, NPTF Rc, W

BSW, BSF

Pg

EG (STI) SELF-LOCK

Tr

Zubehör Accessories

Tech. Info

BGF

ZBGF

GSF

GF

GF-KEG

ZGF

ZIRK-GF

Gigant

MoSys

- Product Finder
- v_c / f_z
- M
- MF
- UNC
UN, UNS
- UNF
UNEF
- G, Rp
- NPT, NPTF
Rc, W
- BSW, BSF
- Pg
- EG (STI)
SELF-LOCK
- Tr
- Zubehör
Accessories
- Tech. Info
- BGF
- ZBGF
- GSF
- GF
- GF-KEG
- ZGF
- ZIRK-GF
- Gigant
- MoSys

UNC, UNF

ASME B1.1

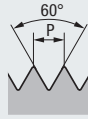

Für Innengewinde
For internal threads

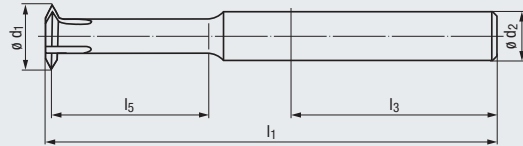

VHM

RH + LH

Z3

DIN 6535

HA

$\varnothing D$

new



Gewindetiefe
Thread depth

2 x D

Einsatzgebiete – Material
Applications – material



- P 1.1-5.1
- K 1.1-4.2
- N 1.1-5, 2.1-6
- N 3.1-2
- N 4.1-2, 5.2
- S 1.1-3

$\varnothing D$	$P_{max.}$ mm	l_1	l_3	l_5	$\varnothing d_1$	$\varnothing d_2$	Z	ZGF-VHM 2xD HA
Nr. 4 - 40	0,635	39	28	6,35	2,06	3	3	GF253701.5003
Nr. 6 - 32	0,794	39	28	7	2,55	3	3	GF253701.5005
Nr. 8 - 32	0,794	42	28	8,35	3,21	4	3	GF253701.5006

Einsatzgebiete – Material
Applications – material



- P 1.1-5.1
- M 1.1-4.1
- K 1.1-4.2
- N 1.1-5.2
- S 1.1-2.6
- H 1.1-2

$\varnothing D$	$P_{max.}$ mm	l_1	l_3	l_5	$\varnothing d_1$	$\varnothing d_2$	Z	ZGF-VHM 2xD HA TICN
Nr. 4 - 40	0,635	39	28	6,35	2,06	3	3	GF253706.5003
Nr. 6 - 32	0,794	39	28	7	2,55	3	3	GF253706.5005
Nr. 8 - 32	0,794	42	28	8,35	3,21	4	3	GF253706.5006

Auch für UNF-Gewinde verwendbar
Suitable also for UNF threads

Andere Ausführungen auf Anfrage
Other designs upon request

UNC

ASME B1.1

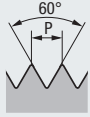

Für Innengewinde
For internal threads

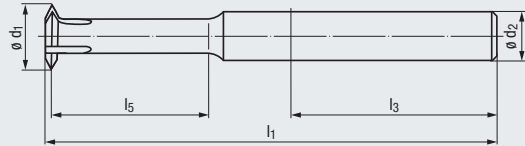

VHM **TICN** **new**

RH + LH

Z3 - Z5 **DIN 6535**

HA HB

ø D



Gewindetiefe
Thread depth

3 x D

Einsatzgebiete – Material
Applications – material

P 1.1-5.1 **M** 1.1-4.1 **K** 1.1-4.2
N 1.1-5.2 **S** 1.1-2.6 **H** 1.1-2

ø D	P _{max.} mm	l ₁	l ₃	l ₅	ø d ₁	ø d ₂	Z	ZGF-VHM 3xD HA TICN	ZGF-VHM 3xD HB TICN
Nr. 2 - 56	0,454	39	28	6,75	1,7	3	3	GF273706.5001	●
Nr. 4 - 40	0,635	40	28	8,85	2,15	3	3	GF273706.5003	●
Nr. 6 - 32	0,794	42	28	10,9	2,7	3	3	GF273706.5005	●
Nr. 10 - 24	1,058	46	28	15	3,7	4	3	GF273706.5007	●
1/4 - 20	1,27	59	36	20,15	4,95	6	4	GF273706.5009	● GF273106.5009 ●
5/16 - 18¹⁾	1,411	65	36	24,5	6,3	8	4	GF273706.5010	● GF273106.5010 ●
3/8 - 16¹⁾	1,588	68	36	29,38	7,7	8	5	GF273706.5011	● GF273106.5011 ●

UNF

ASME B1.1

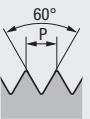

new



new



Einsatzgebiete – Material
Applications – material

P 1.1-5.1 **M** 1.1-4.1 **K** 1.1-4.2
N 1.1-5.2 **S** 1.1-2.6 **H** 1.1-2

ø D	P _{max.} mm	l ₁	l ₃	l ₅	ø d ₁	ø d ₂	Z	ZGF-VHM 3xD HA TICN	ZGF-VHM 3xD HB TICN
Nr. 10 - 32	0,794	46	28	14,85	3,9	4	4	GF273706.5041	●
1/4 - 28	0,907	59	36	19,5	5,25	6	4	GF273706.5043	● GF273106.5043 ●
5/16 - 24¹⁾	1,058	65	36	24,3	6,6	8	5	GF273706.5044	● GF273106.5044 ●
7/16 - 20¹⁾	1,27	77	40	33,95	9,55	10	5	GF273706.5046	● GF273106.5046 ●

¹⁾ Ausführung mit innerer Kühlschmierstoff-Zufuhr IKZ
Design with internal coolant supply IKZ

Teilweise auch für Metrische Gewinde verwendbar
Partly suitable also for Metric threads

Andere Ausführungen auf Anfrage
Other designs upon request

Product Finder

v_c / f_z

M

MF

UNC
UN, UNS

UNF
UNEF

G, Rp

NPT, NPTF
Rc, W

BSW, BSF

Pg

EG (STI)
SELF-LOCK

Tr

Zubehör
Accessories

Tech. Info

BGF

ZBGF

GSF

GF

GF-KEG

ZGF

ZIRK-GF

Gigant

MoSys

- Product Finder
- v_c / f_z
- M
- MF
- UNC
UN, UNS
- UNF
UNEF
- G, Rp
- NPT, NPTF
Rc, W
- BSW, BSF
- Pg
- EG (STI)
SELF-LOCK
- Tr
- Zubehör
Accessories
- Tech. Info
- BGF
- ZBGF
- GSF
- GF
- GF-KEG
- ZGF
- ZIRK-GF
- Gigant
- MoSys

UNC

ASME B1.1



Für Innengewinde
For internal threads

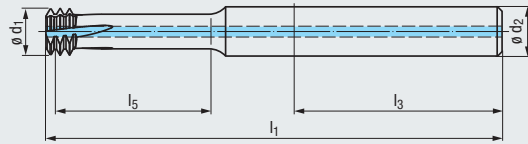

VHM	TIALN T46
RH + LH	LH-rot.
L10	Z3 - Z6
DIN 6535	$\emptyset D$
HA	
HB	

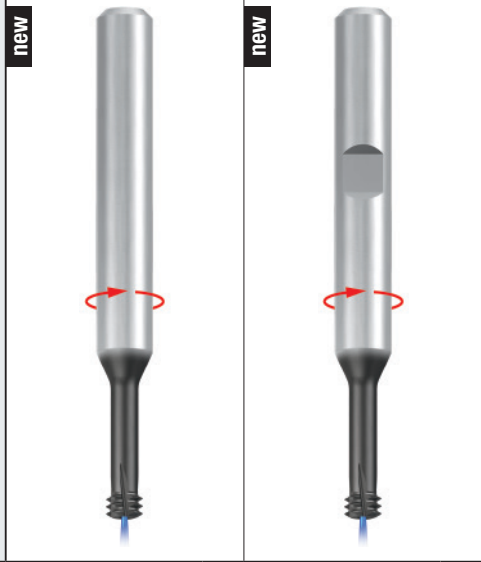

Gewindetiefe
Thread depth

2 x D

Einsatzgebiete – Material
Applications – material

P	1.1-5.1	M	1.1-4.1	K	1.1-4.2
N	1.1-5.2	S	1.1-2.6	H	1.1-2

$\emptyset D$	$P_{max.}$ mm	l_1	l_3	l_5	$\emptyset d_1$	$\emptyset d_2$	Z	ZGF-S-CUT-VHM 2xD IKZ-HA TIALN-T46	ZGF-S-CUT-VHM 2xD IKZ-HB TIALN-T46
Nr. 4 - 40 ²⁾	0,635	39	28	5,95	2,15	3	3	GF26A729.5003	●
Nr. 6 - 32 ²⁾	0,794	39	28	7,3	2,7	3	3	GF26A729.5005	●
Nr. 10 - 24 ²⁾	1,058	42	28	10,1	3,7	4	3	GF26A729.5007	●
1/4 - 20	1,27	55	36	13,2	4,95	6	3	GF26A729.5009	● GF26A129.5009 ●
5/16 - 18	1,411	58	36	16,45	6,3	8	4	GF26A729.5010	● GF26A129.5010 ●
3/8 - 16	1,588	62	36	16,65	7,7	8	4	GF26A729.5011	● GF26A129.5011 ●

UNF

ASME B1.1

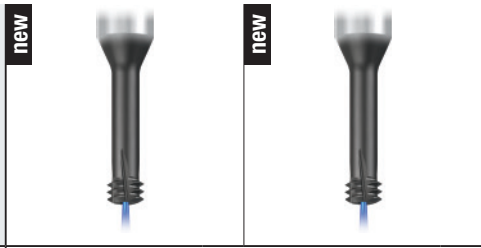

Einsatzgebiete – Material
Applications – material

P	1.1-5.1	M	1.1-4.1	K	1.1-4.2
N	1.1-5.2	S	1.1-2.6	H	1.1-2

$\emptyset D$	$P_{max.}$ mm	l_1	l_3	l_5	$\emptyset d_1$	$\emptyset d_2$	Z	ZGF-S-CUT-VHM 2xD IKZ-HA TIALN-T46	ZGF-S-CUT-VHM 2xD IKZ-HB TIALN-T46
Nr. 10 - 32 ²⁾	0,794	42	28	9,95	3,9	4	4	GF26A729.5041	●
1/4 - 28	0,907	55	36	13,1	5,25	6	5	GF26A729.5043	● GF26A129.5043 ●
5/16 - 24	1,058	58	36	16,3	6,6	8	5	GF26A729.5044	● GF26A129.5044 ●
7/16 - 20	1,27	74	40	22,75	9,55	10	6	GF26A729.5046	● GF26A129.5046 ●

²⁾ Ausführung ohne innerer Kühlschmierstoff-Zufuhr IKZ
Design without internal coolant supply IKZ

Andere Ausführungen auf Anfrage
Other designs upon request

Zirkular-Gewindefräskörper mit einer Fräsplatte 15 mm
Circular thread milling bodies with 1 insert 15 mm

ZIRK-GF

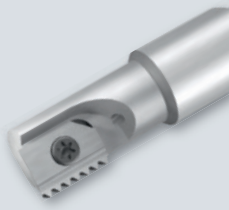

Zirkular-Gewindefräskörper mit zwei Fräsplatten 15 mm
Circular thread milling bodies with 2 inserts 15 mm

ZIRK-GF

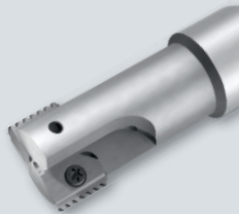

Zirkular-Gewindefräskörper mit einer Fräsplatte 26 mm
Circular thread milling bodies with 1 insert 26 mm

ZIRK-GF

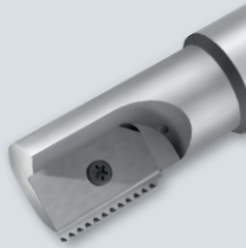

Zirkular-Gewindefräskörper mit Einstechwendeplatte „3-Zahn“
Circular thread milling bodies with indexable infeed insert „3-tooth“

ZIRK-GF¹⁾

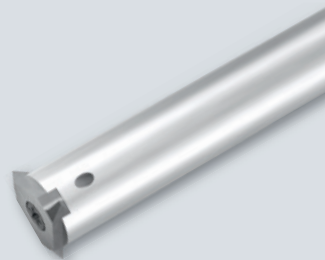

Seite · Page

422

422

424

425

Standard-Fräsplatten 15 mm
Standard inserts 15 mm

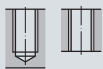

Lange Fräsplatten 26 mm
Long inserts 26 mm

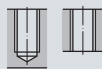

Einstechwendeplatten „3-Zahn“
Indexable infeed inserts, „3-tooth“ design

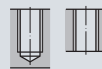

Seite · Page

423

424

425

M, MF

423

UN

423

423

424

424

425

425

G (BSP), BSW, BSF, W

Product Finder

v_c / f_z

M

MF

UNC
UN, UNS

UNF
UNEF

G, Rp

NPT, NPTF
Rc, W

BSW, BSF

Pg

EG (STI)
SELF-LOCK

Tr

Zubehör
Accessories

Tech. Info

BGF

ZBGF

GSF

GF

GF-KEG

ZGF

ZIRK-GF

Gigant

MoSys



¹⁾ Gewindefräszyklus „3-Zahn“ entspricht der Ausführung Gigant, siehe Seite 426
Thread milling cycle corresponding to that of the Gigant design, see page 426

Gewindefräszyklus · Thread milling cycle

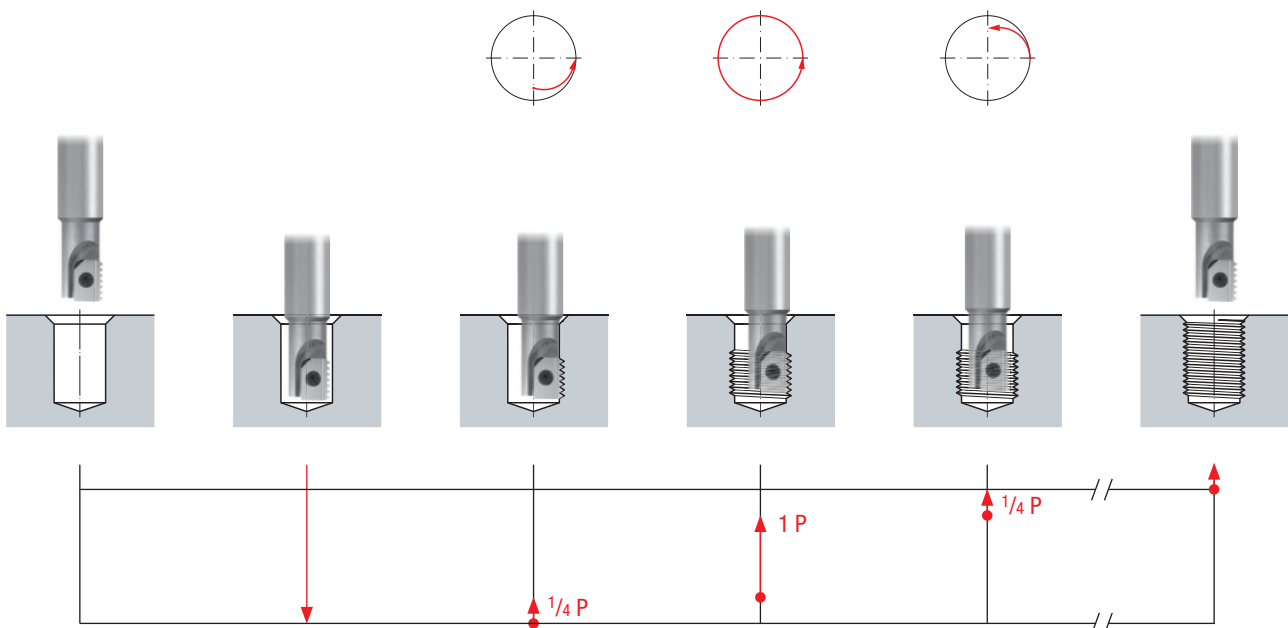

Product Finder

v_c / f_z

M

MF

UNC
UN, UNS

UNF
UNEF

G Rp

NPT, NPTF
Rc, W

BSW, BSF

Pg

EG (STI)
SELF-LOCK

Tr

Zubehör
Accessories

Tech. Info

BGF

ZBGF

GSF

GF

GF-KEG

ZGF

ZIRK-GF

Gigant

MoSys

Ausführung für eine Standard-Fräsplatte 15 mm
Design for 1 standard insert 15 mm

DIN 1835



Kurze Ausführung
Short design

P mm	l_1	l_2	l_3	l_5	$\varnothing d_1$	$\varnothing d_2$ h6	$\varnothing d_3$	ZIRK-GF 15 mm-Z1 IKZN	
0,5 - 2,5	78	15	48	30	16	16	13	GZ301110	●

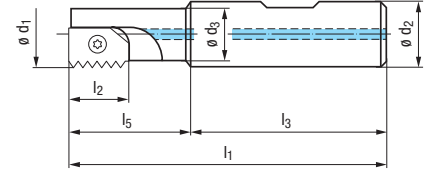

Lange Ausführung
Long design

P mm	l_1	l_2	l_3	l_5	$\varnothing d_1$	$\varnothing d_2$ h6	$\varnothing d_3$	ZIRK-GF 15 mm-Z1 IKZN	
0,5 - 2,5	98	15	48	50	16	16	13	GZ301310 ²⁾	●
0,5 - 2,5	110	15	50	60	20	20	17	GZ301320	●
3,0 - 3,5 ¹⁾	110	15	50	60	22	20	17	GZ301340	●

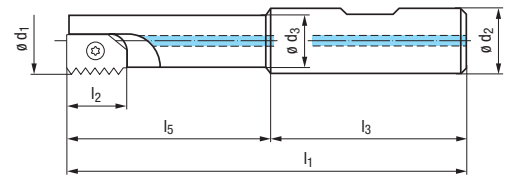

Ausführung für zwei Standard-Fräsplatten 15 mm
Design for 2 standard inserts 15 mm

DIN 1835



Kurze Ausführung
Short design

P mm	l_1	l_2	l_3	l_5	$\varnothing d_1$	$\varnothing d_2$ h6	$\varnothing d_3$	ZIRK-GF 15 mm-Z2 IKZN	
0,5 - 2,5	106	15	56	50	25	25	21	GZ301130	●
3,0 - 3,5 ¹⁾	106	15	56	50	27	25	21	GZ301140	●

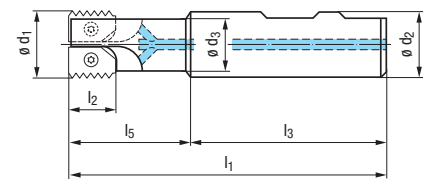

Lange Ausführung
Long design

P mm	l_1	l_2	l_3	l_5	$\varnothing d_1$	$\varnothing d_2$ h6	$\varnothing d_3$	ZIRK-GF 15 mm-Z2 IKZN	
0,5 - 2,5	150	15	56	94	25	25	21	GZ301330 ²⁾	●

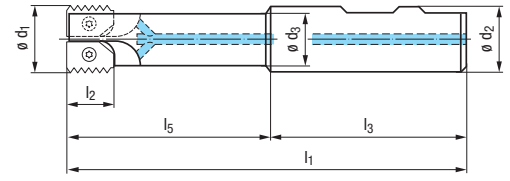

¹⁾ Verstärkte Ausführung
Reinforced design

²⁾ Aus Schwermetall, schwingungsgedämpft
Of vibration-absorbing heavy metal

M, MF

DIN 13

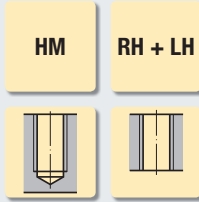
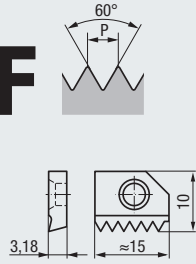

Für Innengewinde
For internal threads

Standard-Fräsplatten 15 mm
Standard inserts 15 mm



Beschichtung · Coating

TIALN-T4

Einsatzgebiete – Material
Applications – material

» 328

P 1.1-5.1	K 1.1-4.2	N 1.1-5	P 1.1-5.1	M 1.1-4.1	K 1.1-4.2
N 2.1-6	N 3.1-4.2, 5.2	S 1.1-3	N 1.1-5.2	S 1.1-2.6	H 1.1-2

P
mm

HM-FP-Z1
15 mm

HM-FP-Z1
15 mm
TIALN-T4

P mm	GF603111.9506		GF603117.9506	
0,5	●		●	
0,75	●		●	
1	●		●	
1,25	●		●	
1,5	●		●	
1,75	●		●	
2	●		●	
2,5	●		●	
3 ¹⁾	●		●	
3,5 ¹⁾	●		●	

UN

ANSI B1.1

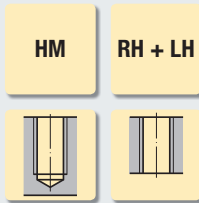
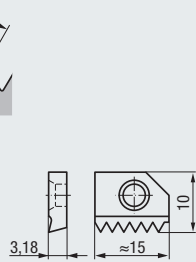

Für Innengewinde
For internal threads

Standard-Fräsplatten 15 mm
Standard inserts 15 mm



Beschichtung · Coating

TIALN-T4

Einsatzgebiete – Material
Applications – material

» 328

P 1.1-5.1	K 1.1-4.2	N 1.1-5	P 1.1-5.1	M 1.1-4.1	K 1.1-4.2
N 2.1-6	N 3.1-4.2, 5.2	S 1.1-3	N 1.1-5.2	S 1.1-2.6	H 1.1-2

P
Gg/1" (tpi)

HM-FP-Z1
15 mm

HM-FP-Z1
15 mm
TIALN-T4

P Gg/1" (tpi)	GF603111.9580		GF603117.9580	
20	●		●	
16	●		●	
14	●		●	
12	●		●	

G (BSP), BSW, BSF, W

DIN EN ISO 228, BS 84

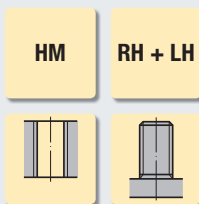
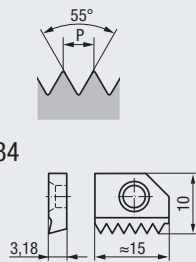

Für Innen- und Außengewinde
For internal and external threads

Standard-Fräsplatten 15 mm
Standard inserts 15 mm



Beschichtung · Coating

TIALN-T4

Einsatzgebiete – Material
Applications – material

» 328

P 1.1-5.1	K 1.1-4.2	N 1.1-5	P 1.1-5.1	M 1.1-4.1	K 1.1-4.2
N 2.1-6	N 3.1-4.2, 5.2	S 1.1-3	N 1.1-5.2	S 1.1-2.6	H 1.1-2

P
Gg/1" (tpi)

HM-FP-Z1
15 mm

HM-FP-Z1
15 mm
TIALN-T4

P Gg/1" (tpi)	GF603111.9548		GF603117.9548	
14	●		●	
11	●		●	

Ersatzschraube M4 x 7; Torx T15
Spare screw M4 x 7; Torx T15 } **GZ309010**

Schraubendreher Torx T15
Screw driver Torx T15 } **GZ309020**

Product Finder

v_c / f_z

M

MF

UNC
UN, UNS

UNF
UNEF

G, Rp

NPT, NPTF
Rc, W

BSW, BSF

Pg

EG (STI)
SELF-LOCK

Tr

Zubehör
Accessories

Tech. Info

BGF

ZBGF

GSF

GF

GF-KEG

ZGF

ZIRK-GF

Gigant

MoSys

Product Finder

v_c / f_z

M

MF

UNC
UN, UNS

UNF
UNEF

G Rp

NPT, NPTF
Rc, W

BSW, BSF

Pg

EG (STI)
SELF-LOCK

Tr

Zubehör
Accessories

Tech. Info

BGF

ZBGF

GSF

GF

GF-KEG

ZGF

ZIRK-GF

Gigant

MoSys



Ausführung für eine lange Fräsplatte 26 mm
Design for 1 long insert 26 mm

DIN 1835



Kurze Ausführung
Short design

P mm	l_1	l_2	l_3	l_5	$\varnothing d_1$	$\varnothing d_2$ h6	$\varnothing d_3$	ZIRK-GF 26 mm-Z1 IKZN
1 - 4	107	26	56	48	25	25	20	GZ303010 ●

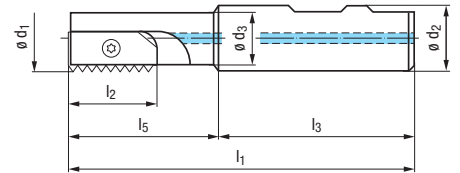

M, MF
DIN 13

HM **RH + LH**

Für Innengewinde
For internal threads

Lange Fräsplatten 26 mm
Long inserts 26 mm



Beschichtung · Coating

TIALN-T4

Einsatzgebiete – Material
Applications – material



P 1.1-5.1	K 1.1-4.2	N 1.1-5	P 1.1-5.1	M 1.1-4.1	K 1.1-4.2
N 2.1-6	N 3.1-4.2, 5.2	S 1.1-3	N 1.1-5.2	S 1.1-2.6	H 1.1-2

P
mm

HM-FP-Z1
26 mm

HM-FP-Z1
26 mm
TIALN-T4

- 1
- 1,5
- 2
- 2,5
- 3
- 3,5
- 4

GF603142.9512	●	GF603147.9514	●
GF603142.9514	●	GF603147.9516	●
GF603142.9516	●	GF603147.9517	●
GF603142.9517	●	GF603147.9518	●
GF603142.9518	●	GF603147.9519	●
GF603142.9519	●	GF603147.9520	●
GF603142.9520	●		

**G (BSP),
BSW, BSF, W**
DIN EN ISO 228, BS 84

HM **RH + LH**

Für Innen- und Außengewinde
For internal and external threads

Lange Fräsplatten 26 mm
Long inserts 26 mm



Beschichtung · Coating

TIALN-T4

Einsatzgebiete – Material
Applications – material



P 1.1-5.1	K 1.1-4.2	N 1.1-5	P 1.1-5.1	M 1.1-4.1	K 1.1-4.2
N 2.1-6	N 3.1-4.2, 5.2	S 1.1-3	N 1.1-5.2	S 1.1-2.6	H 1.1-2

P
Gg/1" (tpi)

HM-FP-Z1
26 mm

HM-FP-Z1
26 mm
TIALN-T4

- 14
- 11

GF603142.9548	●	GF603147.9548	●
GF603142.9550	●	GF603147.9550	●

Ersatzschraube M4 x 13; Torx T15
Spare screw M4 x 13; Torx T15 } **GZ309210**

Schraubendreher Torx T15
Screw driver Torx T15 } **GZ309020**

Für Einstechwendeplatten „3-Zahn“
For indexable infeed inserts, “3-tooth” design

DIN 6535

HB 



Hartmetall-Ausführung
Carbide design

Plattengröße Insert size	l_1	l_3	l_5	$\varnothing d_2$ h6	ZIRK-GF Gr. 02 IKZN
02	112	45	67	12	GZ311330 ●

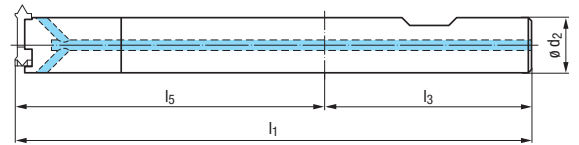

M, MF

DIN 13

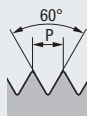

HM

RH + LH



Für Innengewinde
For internal threads

Einstechwendeplatten „3-Zahn“
Indexable infeed inserts, “3-tooth” design



Beschichtung · Coating

TIALN-T4

Einsatzgebiete – Material
Applications – material

» 328

P 1.1-5.1 K 1.1-4.2 N 1.1-5 S 1.1-3
N 2.1-6 N 3.1-4.2, 5.2 S 1.1-3 N 1.1-5.2 S 1.1-2.6 H 1.1-2

Plattengröße
Insert size

P mm

$\varnothing D$

HM-EP-Z3
Gr. 02

HM-EP-Z3
Gr. 02
TIALN-T4

02	1 - 3,5	17,5
02	3	17,5
02	2,5 (M20)	16

GF613121.9512	●	GF613127.9512	●
GF613121.9518	●	GF613127.9518	●
GF613121.0120	●	GF613127.0120	●

**G (BSP),
BSW, BSF, W**

DIN EN ISO 228, BS 84

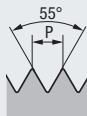

HM

RH + LH



Für Innen- und Außengewinde
For internal and external threads

Einstechwendeplatten „3-Zahn“
Indexable infeed inserts, “3-tooth” design



Beschichtung · Coating

TIALN-T4

Einsatzgebiete – Material
Applications – material

» 328

P 1.1-5.1 K 1.1-4.2 N 1.1-5 S 1.1-3
N 2.1-6 N 3.1-4.2, 5.2 S 1.1-3 N 1.1-5.2 S 1.1-2.6 H 1.1-2

Plattengröße
Insert size

P Gg/1" (tpi)

$\varnothing D$

HM-EP-Z3
Gr. 02

HM-EP-Z3
Gr. 02
TIALN-T4

02	14	17,5
02	11	17,5

GF613121.9548	●	GF613127.9548	●
GF613121.9550	●	GF613127.9550	●

 Ersatzschraube M4 x 11; Torx T15
Spare screw M4 x 11; Torx T15 } **GZ319020**

 Schraubendreher Torx T15
Screw driver Torx T15 } **GZ319060**

Product
Finder

v_c / f_z

M

MF

UNC
UN, UNS

UNF
UNEF

G, Rp

NPT, NPTF
Rc, W

BSW, BSF

Pg

EG (STI)
SELF-LOCK

Tr

Zubehör
Accessories

Tech. Info

BGF

ZBGF

GSF

GF

GF-KEG

ZGF

ZIRK-GF

Gigant

MoSys



Product Finder

v_c / f_z

M

MF

UNC
UN, UNS

UNF
UNEF

G, Rp

NPT, NPTF
Rc, W

BSW, BSF

Pg

EG (STI)
SELF-LOCK

Tr

Zubehör
Accessories

Tech. Info

BGF

ZBGF

GSF

GF

GF-KEG

ZGF

ZIRK-GF

Gigant

MoSys



Werkzeugbeschreibung:

Zirkulargewindefräser mit auswechselbaren Wendeschneidplatten zur Herstellung von großen Innen- und Außengewinden (ab M20). Die Gewindefräsplatten können meist universell (steigungsübergreifend) eingesetzt werden. Voraussetzung ist ein vorgearbeitetes Kernloch und ggf. eine Ansenkung.

Einsatzgebiete:

Niedrig- und hochlegierte Stähle bis 1400 N/mm², nichtrostende Stahlwerkstoffe, Gusswerkstoffe, Aluminium-Legierungen, Kupfer-Legierungen, Magnesium-Legierungen, Kunststoffe sowie Titan-Legierungen.

Tool description:

Circular thread milling bodies with exchangeable inserts for the production of large internal and external threads (from M20). The inserts can mostly be used universally (they are not limited to a single pitch). A ready prepared thread hole, countersunk if necessary, is needed.

Application range:

Low- and high-alloyed steels up to 1400 N/mm², stainless steel materials, cast materials, aluminium alloys, copper alloys, magnesium alloys, synthetics as well as titanium alloys.

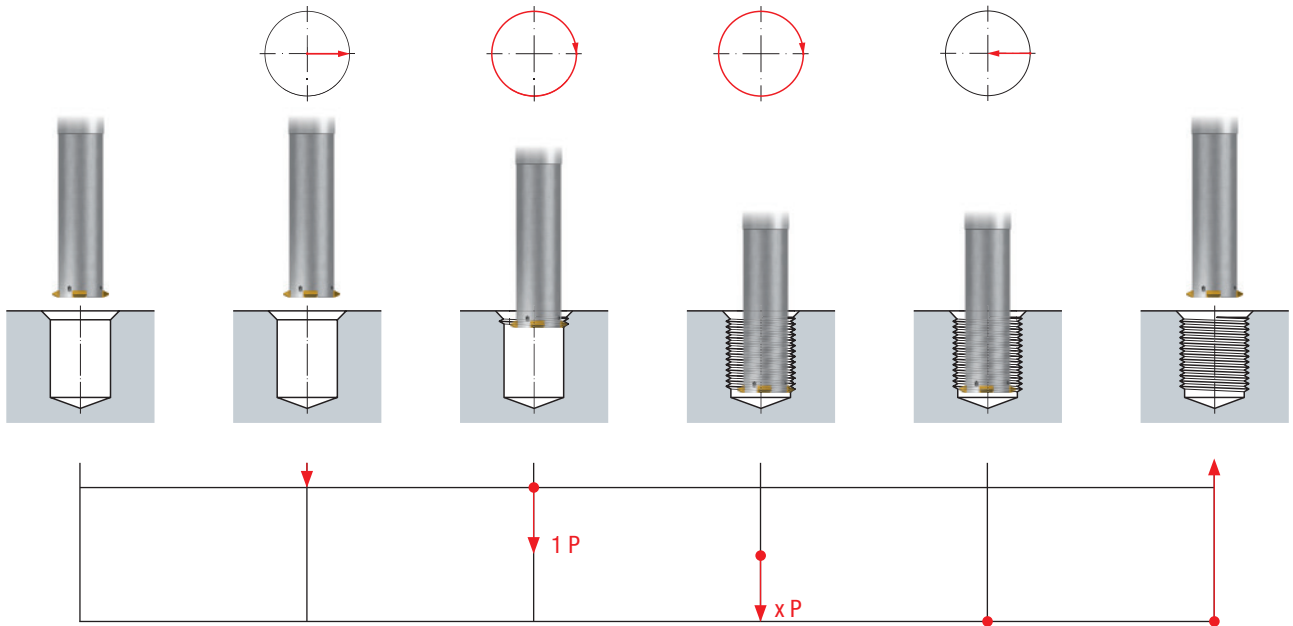

Gewindefräszyklus · Thread milling cycle





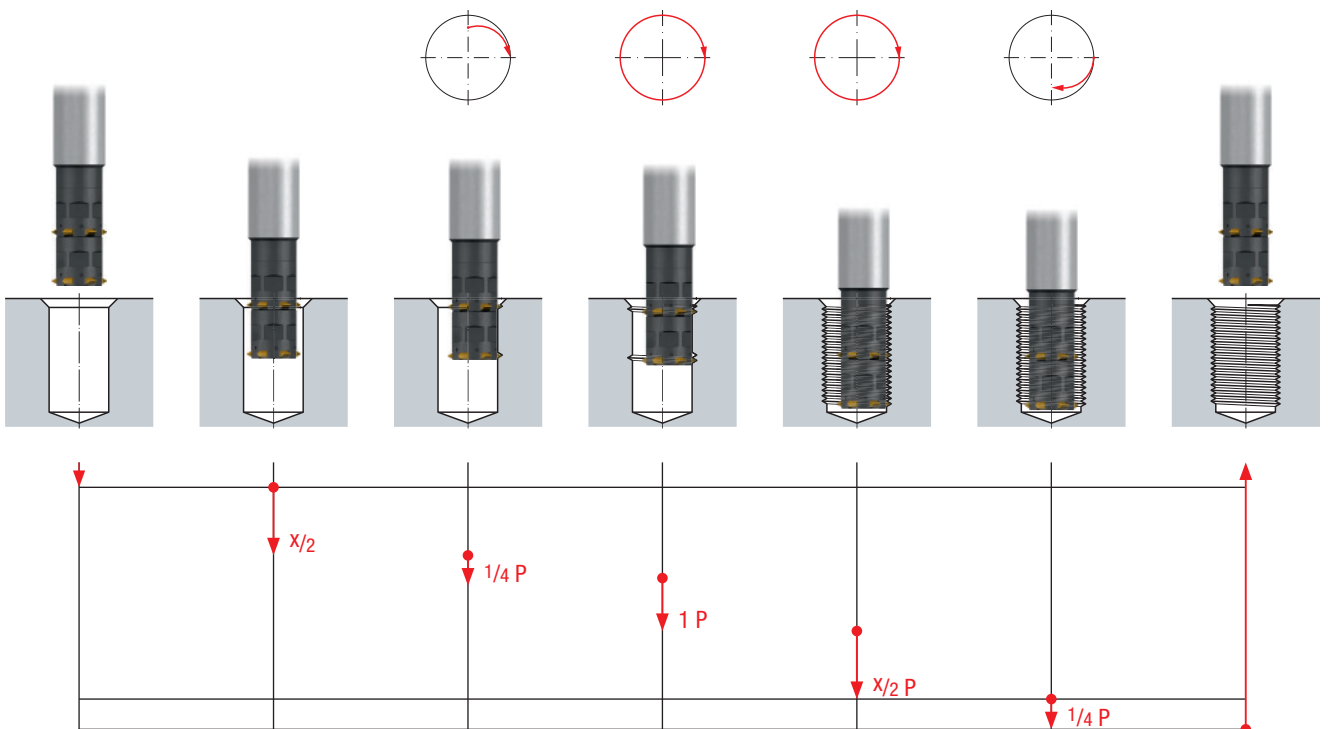

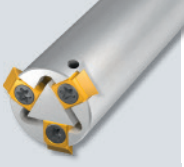
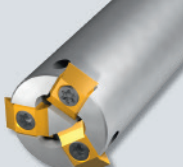
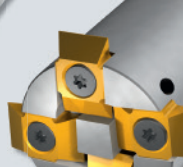
Gewindefräszyklus · Thread milling cycle

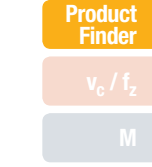
Gigant modular sprinter

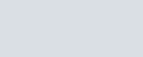

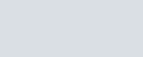
					
$\geq 20 \text{ mm}$	$\geq 30 \text{ mm}$	$\geq 40 \text{ mm}$	$\geq 48 \text{ mm}$	$\geq 64 \text{ mm}$	$\geq 115 \text{ mm}$
Größe Size 10	Größe Size 11	Größe Size 12	Größe Size 13	Größe Size 14	Größe Size 15
Seite · Page					
430	432	434	436	438	440

					
$\leq 3 \text{ mm (8 tpi)}$	$\leq 4 \text{ mm (6 tpi)}$	$\leq 5,5 \text{ mm (4,5 tpi)}$	$\leq 6 \text{ mm (4 tpi)}$	$\leq 8 \text{ mm (3,5 tpi)}$	$\leq 12 \text{ mm (4 tpi)}$
Größe Size 10	Größe Size 11	Größe Size 12	Größe Size 13	Größe Size 14	Größe Size 15
Seite · Page					
431	431	433	433	435	435
431		433		435	
431	431	433	433	435	435
		433		435	
431	431	433	433	435	435

Product Finder

v_c / f_z

M

MF

UNC
UN, UNS

UNF
UNEF

G, Rp

NPT, NPTF
Rc, W

BSW, BSF

Pg

EG (STI)
SELF-LOCK

Tr

Zubehör
Accessories

Tech. Info

BGF

ZBGF

GSF

GF

GF-KEG



ZGF

ZIRK-GF

Gigant

MoSys



	Fräsringe zum Entfernen des unvollständigen Ganges Milling rings for removal of the incomplete thread	442
	Aufnahmen für Gigant Holders for Gigant	444 - 445

Seite · Page

- Product Finder
- v_c / f_z
- M
- MF
- UNC
UN, UNS
- UNF
UNEF
- G, Rp
- NPT, NPTF
Rc, W
- BSW, BSF
- Pg
- EG (STI)
SELF-LOCK
- Tr
- Zubehör
Accessories
- Tech. Info
- BGF
- ZBGF
- GSF
- GF
- GF-KEG
- ZGF
- ZIRK-GF
- Gigant**
- MoSys
- 

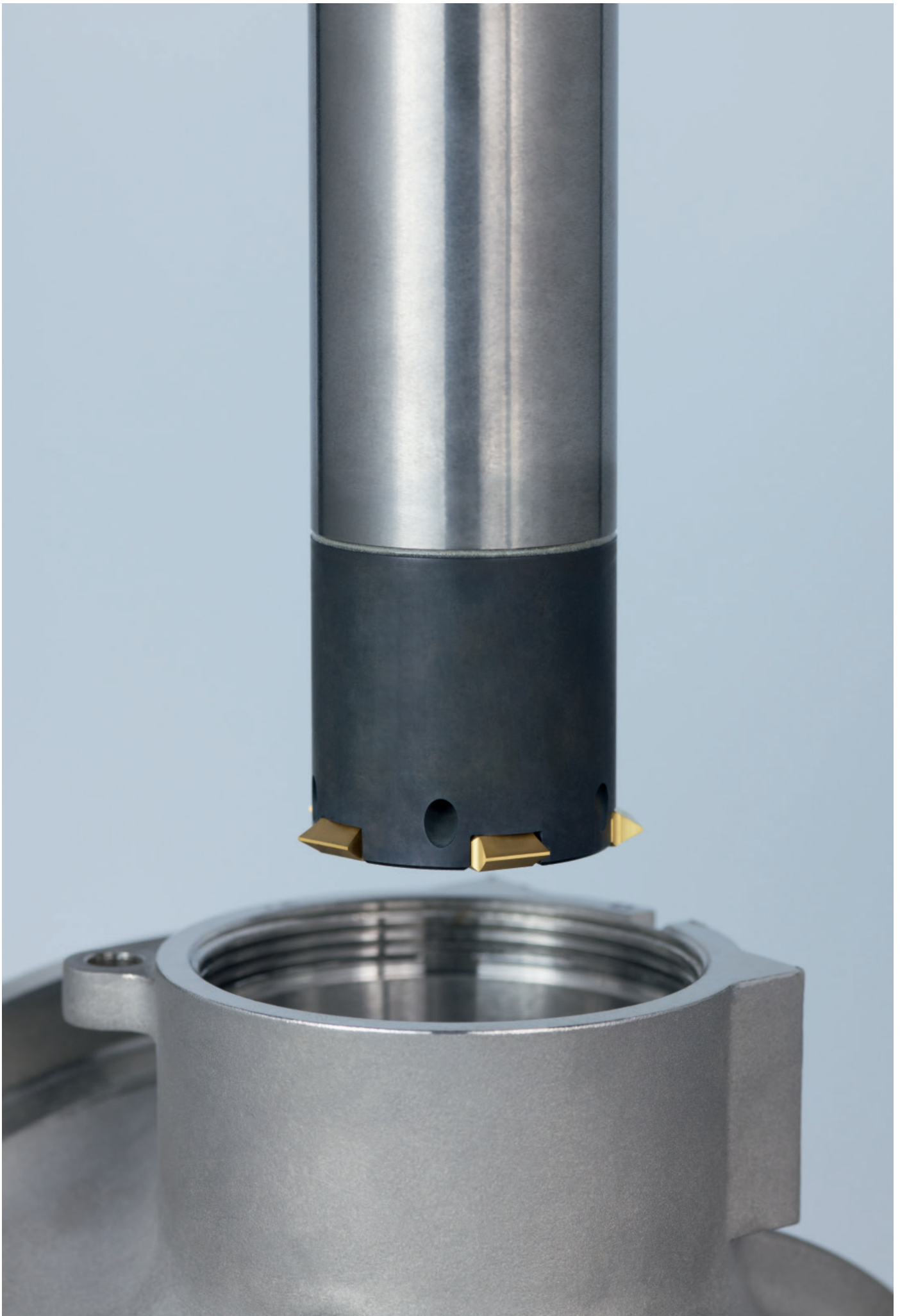

Gigant-ic

Vorteile:

- Flexibilität

Advantages:

- Flexibility

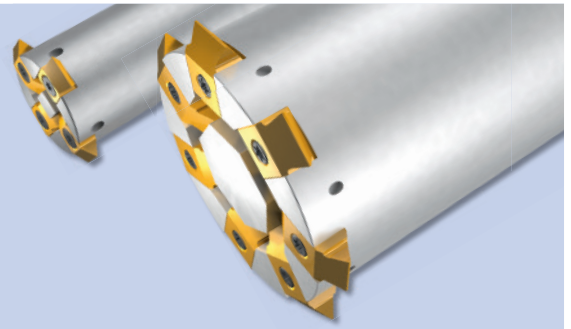

Gigant sprinter

Vorteile:

- Schnelligkeit

Advantages:

- Fast operation

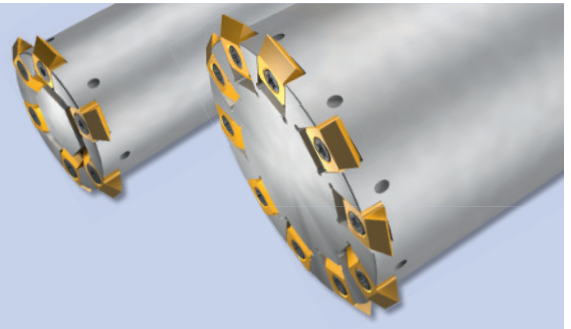

Gigant soft run

Hartmetall-Träger

Carbide tool body

Vorteile:

- Laufruhe
- Stabilität

Advantages:

- Smooth operation
- Stability

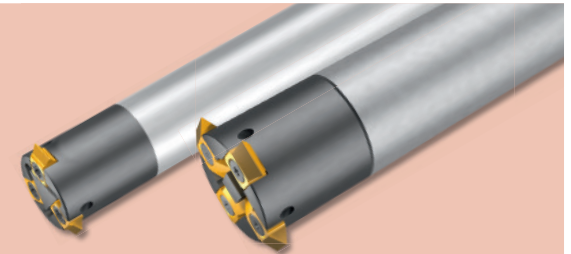

Gigant soft run sprinter

Hartmetall-Träger

Carbide tool body

Vorteile:

- Schnelligkeit
- Laufruhe
- Stabilität

Advantages:

- Fast operation
- Smooth operation
- Stability

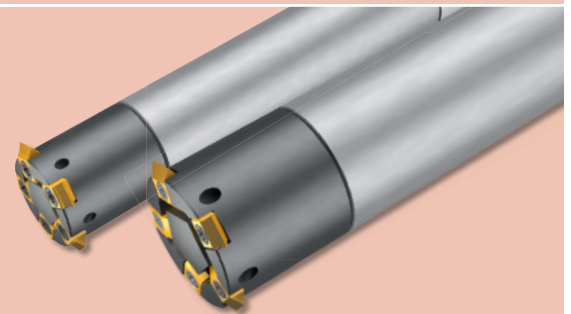

Gigant modular

Vorteile:

- Modularer Aufbau

Advantages:

- Modular construction

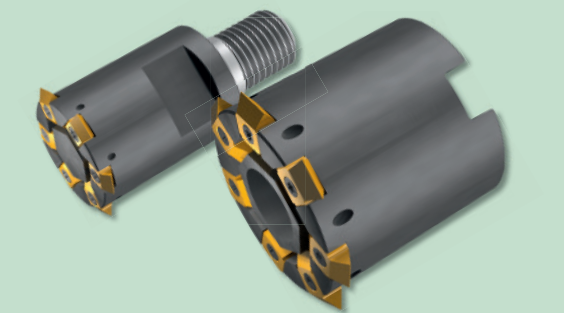

Gigant modular sprinter

Vorteile:

- Flexible Längen
- Kürzere Bearbeitungszeit

Advantages:

- Flexible lengths
- Reduced machining times

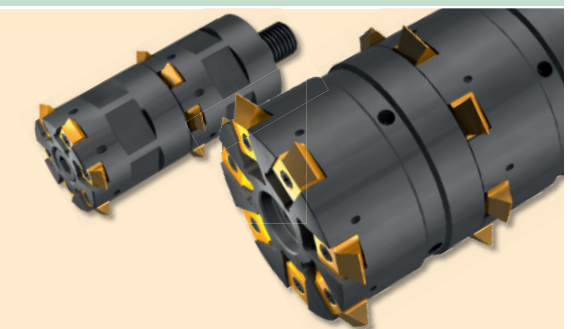

Product Finder

v_c / f_z

M

MF

UNC
UN, UNS

UNF
UNEF

G, Rp

NPT, NPTF
Rc, W

BSW, BSF

Pg

EG (STI)
SELF-LOCK

Tr

Zubehör
Accessories

Tech. Info

BGF

ZBGF

GSF

GF

GF-KEG

ZGF

ZIRK-GF

Gigant

MoSys



10

Für große Abmessungen ab Gewindedurchmesser 20 mm
For large thread sizes, from thread diameter 20 mm

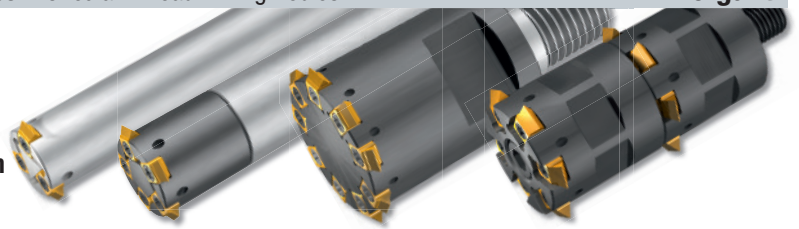

Gigant-ic

Gigant sprinter

DIN 1835 B	Z2 - Z3		Z5							Gigant-ic		Gigant sprinter		
										Gr. 10-1KZN		Gr. 10-1KZN		
Ø D _{min.} mm	l ₁	l ₃	l ₅	Ø d ₁	Ø d ₂ h6	Ø d ₅	Z (Inserts)							
20	87	45	40	17	12	12	2	GZ341000 ●						
24	100	48	50	20,5	16	15,9	3	GZ341040 ●						
24	115	48	65	20,5	16	15,9	3	GZ341050 ●						
30	145	60	80	23,85	32	19	5			GZ341200 ●				

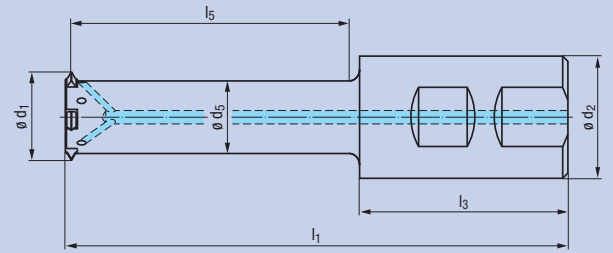

Gigant soft run

Gigant soft run sprinter

DIN 6535 HA	Z2 - Z3		Z5 - Z8							Gigant soft run		Gigant soft run sprinter		
										Gr. 10-1KZN		Gr. 10-1KZN		
Ø D _{min.} mm	l ₁	l ₃	l ₅	Ø d ₁	Ø d ₂ h6	Ø d ₅	Z (Inserts)							
20	97	45	50	17	12	12	2	GZ34A010 ●						
24	115	48	65	20,5	16	15,9	3	GZ34A000 ●						
30	142	50	90	23,85	20	19	5			GZ34C000 ●				
36	153	56	95	30	25	25	7			GZ34C010 ●				
40	178	60	115	32,85	32	27,7	8			GZ34C020 ●				

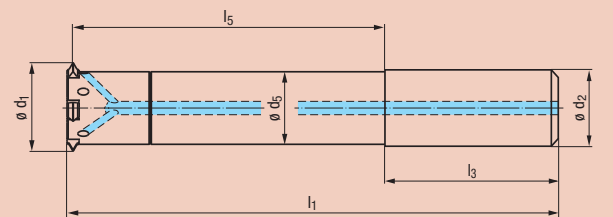

Mit variabler Länge auf Anfrage
With variable length upon request

Gigant modular

Nur einzeln einsetzbar
Can only be used individually

M	Z9							Gigant modular		
								Gr. 10-1KZN		
Ø D _{min.} mm	l ₆	Ø d ₁	Ø d ₅	G ₁	SW (W/F)	Z (Inserts)				
40	38	34,25	28,8	M16	22	9	GZ351000 ●			

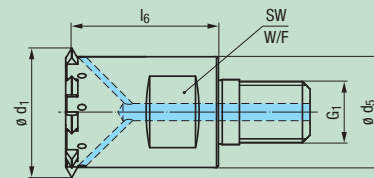

Gigant modular sprinter

Je nach Anwendung empfehlen wir, max. 3 Gigant modular sprinter miteinander zu kombinieren
Depending on the application, we recommend to combine up to a maximum of 3 Gigant modular sprinter

MF	Z6							Gigant modular Sprinter		
								Gr. 10-1KZN		
new Ø D _{min.} mm	l ₇	Ø d ₁	Ø d ₅	G ₁	SW (W/F)	Z (Inserts)				
32	24	27	22,15	M8 x 1	19	6	GZ353000 ●			

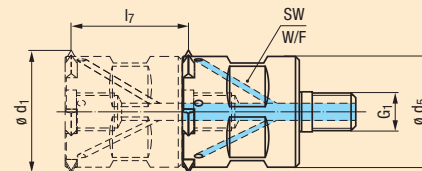

Die Innensechskant-Schraube zum stirnseitigen Verschließen der Kühlmittel-Bohrung ist im Lieferumfang enthalten
The hexagon socket screw to close the coolant hole on the face side is included with the delivery

Das Maß l₇ muss ein Vielfaches der Steigung P des herzustellenden Gewindes sein
The measurement l₇ must be a multiple of the pitch P of the thread to be produced

Fräsringe zum Entfernen des unvollständigen Ganges siehe Seite 442
Milling rings for removal of the incomplete thread, see page 442

Aufnahmen und Verlängerungen für Gigant modular und Gigant modular sprinter siehe Seite 444 - 445
Holders and extensions for Gigant modular and Gigant modular sprinter, see pages 444 - 445

10

2-Zahnwendeplatten für Steigungsbereich bis 3 mm (8 Gg/1") 2-tooth indexable inserts for a pitch range up to 3 mm (8 tpi)

	HM RH + LH		
Beschichtung · Coating		TIN	TIALN-T4
Einsatzgebiete – Material Range of application – material 328		P 1.1-5.1 M 1.1-4.1 K 1.1-4.2 N 1.1-4.4 S 1.1-3	
P mm	P Gg/1" (tpi)	b	h
		HM-WP-Z2 Gr. 10 TIN	HM-WP-Z2 Gr. 10 TIALN-T4

M, MF, UN DIN 13, ANSI B1.1			
1 - 2,5 1,5 - 3	24 - 10 16 - 8	5 5	7 7
		GF643005.9512 GF643005.9514	● ●
		GF643007.9512 GF643007.9514	● ●

M, MF DIN 13			new
1,5 2	5 5	7 7	
			GF641007.9514 GF641007.9516
			● ●

G (BSP), BSW, BSF, W DIN EN ISO 228, BS 84				
(1,814)	14 (9 - 28)	5	7	
				GF643005.9548
				●
				GF643007.9548
				●

Tr DIN 103					new
1,5 2	5 5	7 7	$\varnothing D_{min.} = d_1 + 11$ $\varnothing D_{min.} = d_1 + 14$		
					GF643007.9597 GF643007.9599
					● ●

Andere Ausführungen auf Anfrage, z.B.
Other designs upon request, e.g.



Einstechplatten in verschiedenen Ausführungen
Inserts in various designs

Zubehör
Accessories

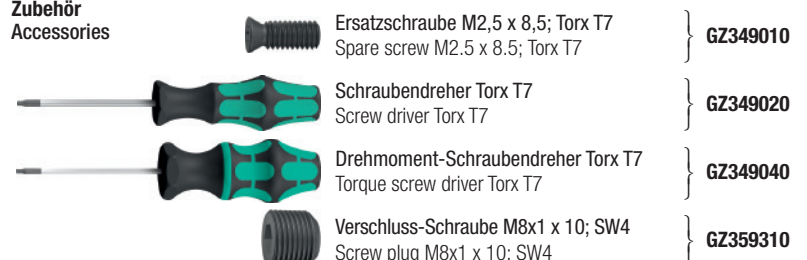

Product Finder

v_c / f_z

M

MF

UNC
UN, UNS

UNF
UNEF

G, Rp

NPT, NPTF
Rc, W

BSW, BSF

Pg

EG (STI)
SELF-LOCK

Tr

Zubehör
Accessories

Tech. Info

BGF

ZBGF

GSF

GF

GF-KEG

ZGF

ZIRK-GF

Gigant

MoSys

Product Finder

v_c / f_z

M

MF

UNC
UN, UNS

UNF
UNEF

G Rp

NPT, NPTF
Rc, W

BSW, BSF

Pg

EG (STI)
SELF-LOCK

Tr

Zubehör
Accessories

Tech. Info

BGF

ZBGF

GSF

GF

GF-KEG

ZGF

ZIRK-GF

Gigant

MoSys



11

Für große Abmessungen ab Gewindedurchmesser 30 mm
For large thread sizes, from thread diameter 30 mm

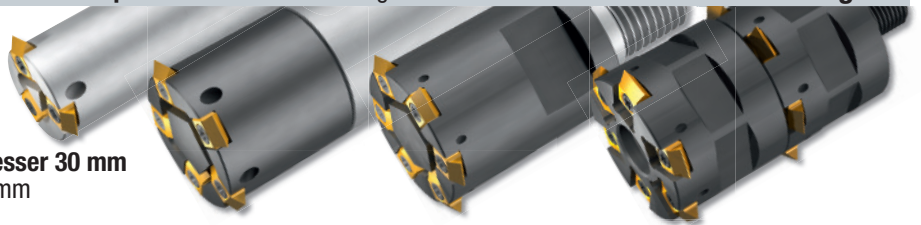

Gigant-ic

Gigant sprinter

DIN 1835 B



Z3

Z5 - Z8

$\emptyset D_{min.}$ mm	l_1	l_3	l_5	$\emptyset d_1$	$\emptyset d_2$ h6	$\emptyset d_5$	Z (Inserts)	Gigant-ic		Gigant sprinter	
								Gr. 11-IKZN		Gr. 11-IKZN	
30	122	60	60	23,85	32	19	3	GZ341121	●		
30	138	56	80	23,85	25	19	3	GZ341021	●		
30	142	60	80	23,85	32	19	3	GZ341001	●		
30	152	60	90	23,85	32	19	3	GZ341101	●		
34	153	60	90	28	32	23	5			GZ341211	●
36	157	60	95	29,5	32	24,5	3	GZ341131	●		
40	159	60	95	32,85	32	27,7	5			GZ341201	●
40	124	60	60	34	32	28,8	6			GZ341221	●
48	144	60	80	40,25	32	35	8			GZ341231	●

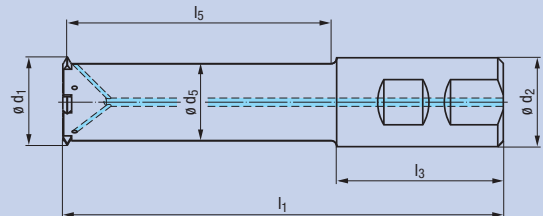

Gigant soft run

Gigant soft run sprinter

DIN 6535 HA



Z3

Z5

$\emptyset D_{min.}$ mm	l_1	l_3	l_5	$\emptyset d_1$	$\emptyset d_2$ h6	$\emptyset d_5$	Z (Inserts)	Gigant soft run		Gigant soft run sprinter	
								Gr. 11-IKZN		Gr. 11-IKZN	
30	142	50	90	23,85	20	19	3	GZ34A001	●		
40	179	60	115	32,85	32	27,7	5			GZ34C001	●

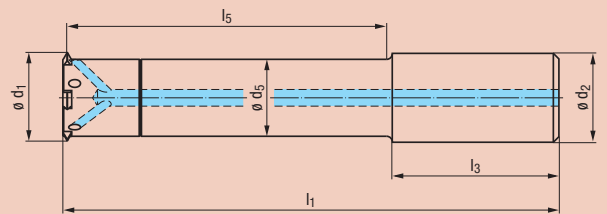

Mit variabler Länge auf Anfrage
With variable length upon request

Gigant modular

M



Z6

$\emptyset D_{min.}$ mm	l_6	$\emptyset d_1$	$\emptyset d_5$	G_1	SW (W/F)	Z (Inserts)	Gigant modular	
							Gr. 11-IKZN	
42	38	34,25	28,8	M16	22	6	GZ351001	●

Nur einzeln einsetzbar
Can only be used individually

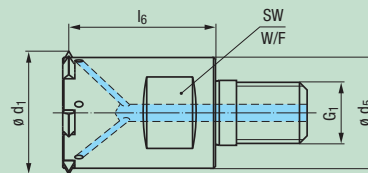

Gigant modular sprinter

MF



Z6

new	$\emptyset D_{min.}$ mm	l_7	$\emptyset d_1$	$\emptyset d_5$	G_1	SW (W/F)	Z (Inserts)	Gigant modular sprinter		
									Gr. 11-IKZN	
	42	24	34,25	29,15	M10 x 1	25	6	GZ353001	●	

Je nach Anwendung empfehlen wir, max. 3 Gigant modular sprinter
miteinander zu kombinieren
Depending on the application, we recommend to combine up to a maximum
of 3 Gigant modular sprinter

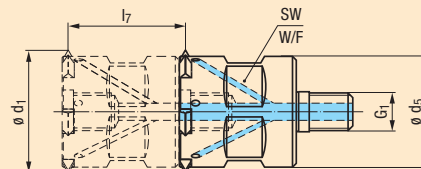

Die Innensechskant-Schraube zum stirnseitigen Verschließen der Kühlmittel-Bohrung
ist im Lieferumfang enthalten
The hexagon socket screw to close the coolant hole on the face side
is included with the delivery

Das Maß l_7 muss ein Vielfaches der Steigung P des herzustellenden Gewindes sein
The measurement l_7 must be a multiple of the pitch P of the thread to be produced

Fräsringe zum Entfernen des unvollständigen Ganges siehe Seite 442
Milling rings for removal of the incomplete thread, see page 442

Aufnahmen und Verlängerungen für Gigant modular und Gigant modular sprinter siehe Seite 444 - 445
Holders and extensions for Gigant modular and Gigant modular sprinter, see pages 444 - 445

11

4-Zahnwendeplatten für Steigungsbereich bis 4 mm (6 Gg/1") 4-tooth indexable inserts for a pitch range up to 4 mm (6 tpi)

	<div style="display: flex; gap: 10px;"> <div style="border: 1px solid black; padding: 2px;">HM</div> <div style="border: 1px solid black; padding: 2px;">RH + LH</div> </div>		
	Beschichtung · Coating		TIN
Einsatzgebiete – Material Range of application – material » 328		<div style="display: flex; justify-content: space-between; font-size: small;"> P 1.1-5.1 M 1.1-4.1 K 1.1-4.2 </div> <div style="display: flex; justify-content: space-between; font-size: small;"> N 1.1-4.4 S 1.1-3 </div>	
P mm	P Gg/1" (tpi)	b	h
		HM-WP-Z4 Gr. 11 TIN	HM-WP-Z4 Gr. 11 TIALN-T4

<h3>M, MF, UN</h3> <p>DIN 13, ANSI B1.1</p>							
1 - 2,5	24 - 10	6,35	9,52	GF643105.9512	●	GF643107.9512	●
1,5 - 2,5	16 - 10	6,35	9,52	GF643105.9514	●	GF643107.9514	●
2,5 - 4	10 - 6	6,35	9,52	GF643105.9517	●	GF643107.9517	●

<h3>M, MF</h3> <p>DIN 13</p>						new
2,5		6,35	9,52		GF641107.9517	●
3		6,35	9,52		GF641107.9518	●

<h3>G (BSP), BSW, BSF, W</h3> <p>DIN EN ISO 228, BS 84</p>							
(2,309)	11 (9 - 28)	6,35	9,52	GF643105.9550	●	GF643107.9550	●

<h3>NPT</h3> <p>ANSI/ASME B1.20.1</p>						new	
(2,209)	11 1/2	6,35	9,52			GF643107.9679	●

<h3>Tr</h3> <p>DIN 103</p>						new	
3		6,35	9,52	$\varnothing D_{min.} = d_1 + 23$		GF643107.9601	●
4		6,35	9,52	$\varnothing D_{min.} = d_1 + 32$		GF643107.9603	●

Andere Ausführungen auf Anfrage, z.B.
Other designs upon request, e.g.



Einstechplatten in verschiedenen Ausführungen
Infeed inserts in various designs

Zubehör
Accessories

- Ersatzschraube M2,5 x 8,5; Torx T7
Spare screw M2.5 x 8.5; Torx T7
 } GZ349011
- Schraubendreher Torx T7
Screw driver Torx T7
 } GZ349021
- Drehmoment-Schraubendreher Torx T7
Torque screw driver Torx T7
 } GZ349041
- Verschluss-Schraube M10x1 x 12; SW5
Screw plug M10x1 x 12; SW5
 } GZ359311

Product Finder

v_c / f_z

M

MF

UNC
UN, UNS

UNF
UNEF

G, Rp

NPT NPTF
Rc, W

BSW, BSF

Pg

EG (STI)
SELF-LOCK

Tr

Zubehör
Accessories

Tech. Info

BGF

ZBGF

GSF

GF

GF-KEG

ZGF

ZIRK-GF

Gigant

MoSys

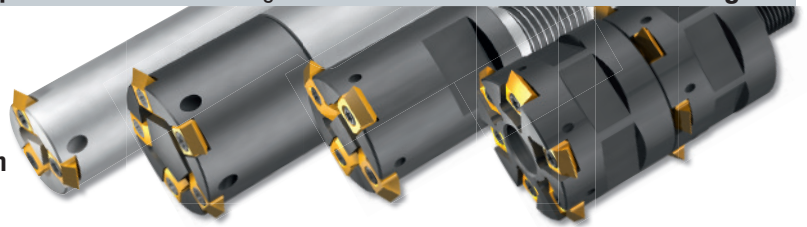

12

Für große Abmessungen ab Gewindedurchmesser 40 mm
For large thread sizes, from thread diameter 40 mm

Gigant-ic

Gigant sprinter

DIN 1835 B	Z3		Z5						
$\emptyset D_{min.}$ mm	l_1	l_3	l_5	$\emptyset d_1$	$\emptyset d_2$ h6	$\emptyset d_5$	Z (Inserts)	Gigant-ic Gr. 12-1KZN	Gigant sprinter Gr. 12-1KZN
40	153	56	95	32,85	25	24,5	3	GZ341032 ●	
40	158	60	95	32,85	32	24,5	3	GZ341012 ●	
40	178	60	115	32,85	32	24,5	3	GZ341112 ●	
48	172	60	110	40,25	32	31,9	5		GZ341202 ●

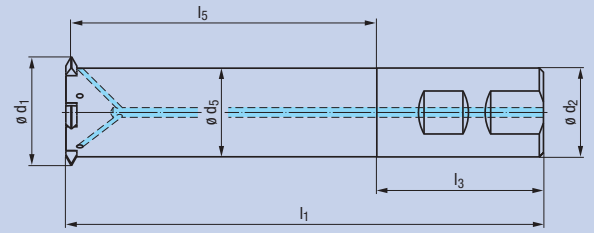

Gigant soft run

Gigant soft run sprinter

DIN 6535 HA	Z3		Z5						
$\emptyset D_{min.}$ mm	l_1	l_3	l_5	$\emptyset d_1$	$\emptyset d_2$ h6	$\emptyset d_5$	Z (Inserts)	Gigant soft run Gr. 12-1KZN	Gigant soft run sprinter Gr. 12-1KZN
40	173	56	115	32,85	25	24,5	3	GZ34A002 ●	
48	207	60	145	40,25	32	31,9	5		GZ34C002 ●

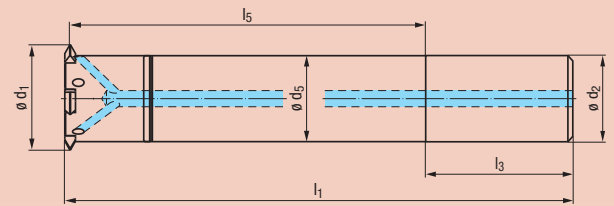

Mit variabler Länge auf Anfrage
With variable length upon request

Gigant modular

Nur einzeln einsetzbar
Can only be used individually

M	Z4						
$\emptyset D_{min.}$ mm	l_6	$\emptyset d_1$	$\emptyset d_5$	G_1	SW (W/F)	Z (Inserts)	Gigant modular Gr. 12-1KZN
46	38	37,5	28,8	M16	22	4	GZ351002 ●

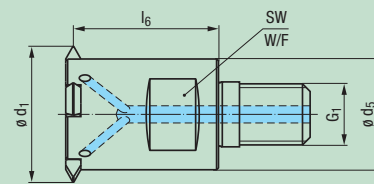

Gigant modular sprinter

Je nach Anwendung empfehlen wir, max. 3 Gigant modular sprinter miteinander zu kombinieren
Depending on the application, we recommend to combine up to a maximum of 3 Gigant modular sprinter

MF	Z6						
$\emptyset D_{min.}$ mm	l_7	$\emptyset d_1$	$\emptyset d_5$	G_1	SW (W/F)	Z (Inserts)	Gigant modular sprinter Gr. 12-1KZN
58	36	46	37,65	M12 x 1	32	6	GZ353002 ●

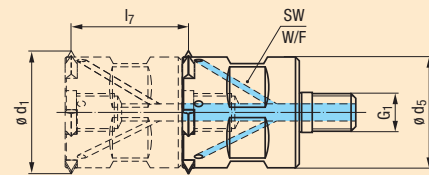

Das Maß l_7 muss ein Vielfaches der Steigung P des herzustellenden Gewindes sein
The measurement l_7 must be a multiple of the pitch P of the thread to be produced







Die Innensechskant-Schraube zum stirnseitigen Verschließen der Kühlmittel-Bohrung ist im Lieferumfang enthalten
The hexagon socket screw to close the coolant hole on the face side is included with the delivery

Fräsringe zum Entfernen des unvollständigen Ganges siehe Seite 442
Milling rings for removal of the incomplete thread, see page 442

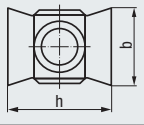
Aufnahmen und Verlängerungen für Gigant modular und Gigant modular sprinter siehe Seite 444 - 445
Holders and extensions for Gigant modular and Gigant modular sprinter, see pages 444 - 445

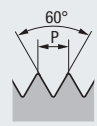
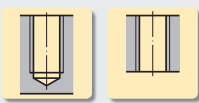
12

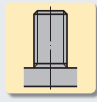
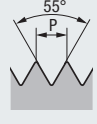
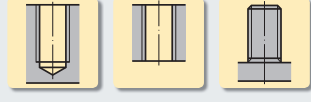
4-Zahnwendeplatten für Steigungsbereich bis 5,5 mm (4,5 Gg/1") 4-tooth indexable inserts for a pitch range up to 5.5 mm (4.5 tpi)

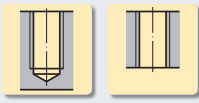
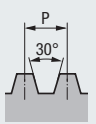
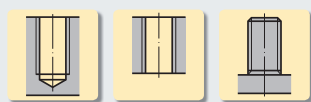
				HM	RH + LH		
Einsatzgebiete – Material Range of application – material				Beschichtung · Coating			
P mm	P Gg/1" (tpi)	b	h	HM-WP-Z4 Gr. 12 TIN		HM-WP-Z4 Gr. 12 TIALN-T4	
M, MF, UN DIN 13, ANSI B1.1  				P 1.1-5.1 M 1.1-4.1 K 1.1-4.2 N 1.1-4.4 S 1.1-3			
1,5 - 2,5 2,5 - 5,5	16 - 10 10 - 4,5	8,5 8,5	13,5 13,5	GF643205.9514 GF643205.9517	● ●	GF643207.9514 GF643207.9517	● ●
M, MF DIN 13  						new GF641207.9519 GF641207.9520	
3,5 4		8,5 8,5	13,5 13,5				● ●
G (BSP), BSW, BSF, W DIN EN ISO 228, BS 84  						GF643205.9550 GF643207.9550	
(2,309)	11 (5 - 28)	8,5	13,5		●		●
NPT ANSI/ASME B1.20.1  						new GF643207.9680	
(3,175)	8	8,5	13,5				●
Tr DIN 103  						new GF643207.9603 GF643207.9604	
4 5		8,5 8,5	13,5 13,5	$\varnothing D_{min.} = d_1 + 32$ $\varnothing D_{min.} = d_1 + 41$			● ●

Andere Ausführungen auf Anfrage, z.B.
Other designs upon request, e.g.



 Einstechplatten in verschiedenen Ausführungen
Infeed inserts in various designs

Zubehör
Accessories

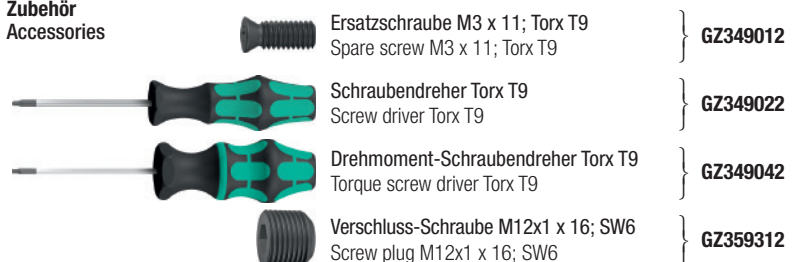

Product Finder

v_c / f_z

M

MF

UNC
UN, UNS

UNF
UNEF

G, Rp

NPT NPTF
Rc, W

BSW, BSF

Pg

EG (STI)
SELF-LOCK

Tr

Zubehör
Accessories

Tech. Info

BGF

ZBGF

GSF

GF

GF-KEG

ZGF

ZIRK-GF

Gigant

MoSys



13

Für große Abmessungen ab Gewindedurchmesser 48 mm
For large thread sizes, from thread diameter 48 mm

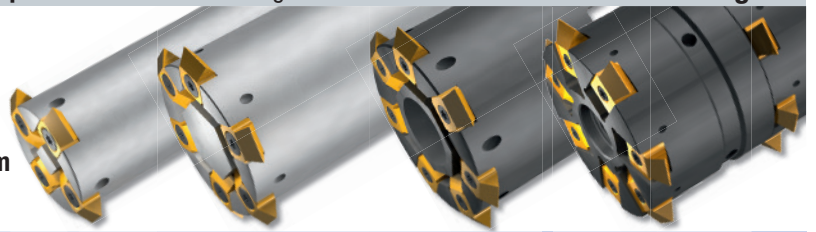

Gigant-ic

Gigant sprinter

DIN 1835 B			Z4					
$\emptyset D_{min.}$ mm	l_1	l_3	l_5	$\emptyset d_1$	$\emptyset d_2$ h6	$\emptyset d_5$	Z (Inserts)	Gigant-ic Gr. 13-IKZN
48	173	60	110	40,25	32	31	4	GZ341153 ●
48	208	60	145	40,25	32	31	4	GZ341143 ●

DIN 69871			Z4		Z6			
$\emptyset D_{min.}$ mm	l_1	l_5	$\emptyset d_1$	SK	$\emptyset d_5$	Z (Inserts)	Gigant-ic Gr. 13-IKZN	Gigant sprinter Gr. 13-IKZN
48	212	110	40,25	SK 40	31	4	GZ343003 ●	
48	245	110	40,25	SK 50	31	4	GZ344003 ●	
48	247	145	40,25	SK 40	31	4	GZ343103 ●	
48	280	145	40,25	SK 50	31	4	GZ344103 ●	
64	333	195	52,55	SK 50	43,75	6		GZ344203 ●

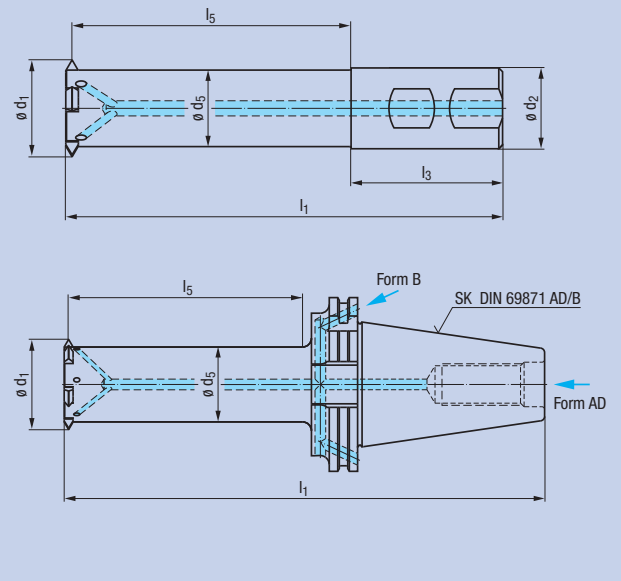

Gigant soft run

DIN 6535 HA			Z4					
$\emptyset D_{min.}$ mm	l_1	l_3	l_5	$\emptyset d_1$	$\emptyset d_2$ h6	$\emptyset d_5$	Z (Inserts)	Gigant soft run Gr. 13-IKZN
48	207	60	145	40,25	32	31	4	GZ34A003 ●

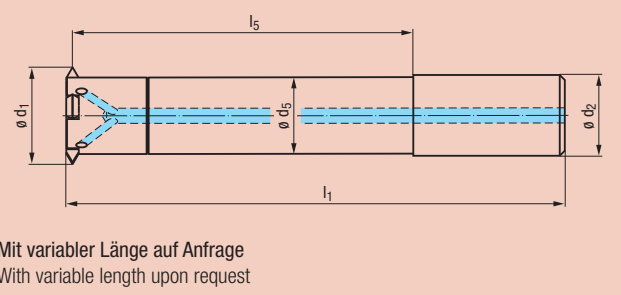

Gigant modular

DIN 138			Z7			
$\emptyset D_{min.}$ mm	l_6	$\emptyset d_1$	$\emptyset d_5$	$\emptyset D_3$	Z (Inserts)	Gigant modular Gr. 13-IKZN
66	47,5	57,5	48	27	7	GZ352003 ●

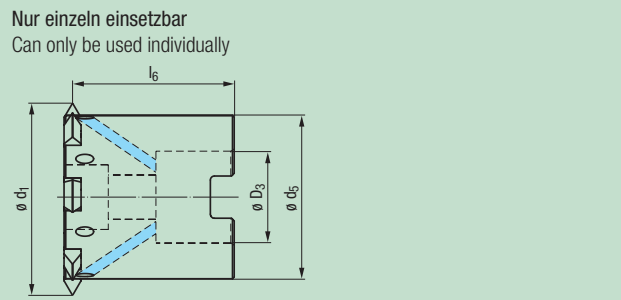

Gigant modular sprinter

MF			Z7				
new	$\emptyset D_{min.}$ mm	l_7	$\emptyset d_1$	$\emptyset d_5$	G ₁	Z (Inserts)	Gigant modular sprinter Gr. 13-IKZN
	66	48	57,5	48	M18 x 1,5	7	GZ353003 ●

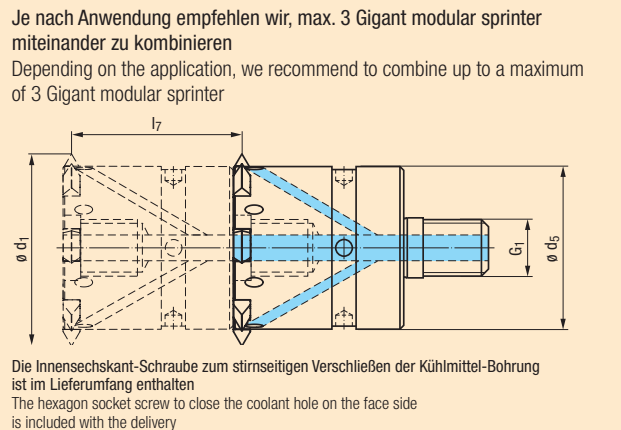

Das Maß l_7 muss ein Vielfaches der Steigung P des herzustellenden Gewindes sein
The measurement l_7 must be a multiple of the pitch P of the thread to be produced

- Fräsringe zum Entfernen des unvollständigen Ganges siehe Seite 442
Milling rings for removal of the incomplete thread, see page 442
- Aufnahmen und Verlängerungen für Gigant modular und Gigant modular sprinter siehe Seite 444 - 445
Holders and extensions for Gigant modular and Gigant modular sprinter, see pages 444 - 445

13

4-Zahnwendeplatten für Steigungsbereich bis 6 mm (4 Gg/1")
 4-tooth indexable inserts for a pitch range up to 6 mm (4 tpi)

	<div style="display: flex; gap: 10px;"> <div style="border: 1px solid black; padding: 2px;">HM</div> <div style="border: 1px solid black; padding: 2px;">RH + LH</div> </div>		
	Beschichtung · Coating		TIN
Einsatzgebiete – Material Range of application – material » 328		<div style="display: flex; justify-content: space-between;"> <div style="text-align: center;"> P 1.1-5.1 N 1.1-4.4 </div> <div style="text-align: center;"> M 1.1-4.1 S 1.1-3 </div> <div style="text-align: center;"> K 1.1-4.2 </div> </div>	
P mm	P Gg/1" (tpi)	b	h
		HM-WP-Z4 Gr. 13 TIN	HM-WP-Z4 Gr. 13 TIALN-T4

<h2>M, MF, UN</h2> <p>DIN 13, ANSI B1.1</p>					
1,5 - 3 3 - 6	16 - 9 9 - 4	9,5 9,5	15,5 15,5	GF643305.9514 ● GF643305.9518 ●	GF643307.9514 ● GF643307.9518 ●

<h2>M, MF</h2> <p>DIN 13</p>				new	
4,5 5		9,5 9,5	15,5 15,5		GF641307.9521 ● GF641307.9522 ●

<h2>G (BSP), BSW, BSF, W</h2> <p>DIN EN ISO 228, BS 84</p>					
(2,309)	11 (4.5 - 12)	9,5	15,5	GF643305.9550 ●	GF643307.9550 ●

<h2>Tr</h2> <p>DIN 103</p>				new	
5 6		9,5 9,5	15,5 15,5	$\varnothing D_{min.} = d_1 + 43$ $\varnothing D_{min.} = d_1 + 53$	GF643307.9604 ● GF643307.9605 ●

Andere Ausführungen auf Anfrage, z.B.
 Other designs upon request, e.g.



Zubehör
 Accessories

- Ersatzschraube M4 x 13; Torx T15
 Spare screw M4 x 13; Torx T15 } **GZ349013**
- Schraubendreher Torx T15
 Screw driver Torx T15 } **GZ349023**
- Drehmoment-Schraubendreher Torx T15
 Torque screw driver Torx T15 } **GZ349043**
- Hakenschlüssel mit Zapfen
 nach DIN 1810-B 45-50 mm
 Hook wrench type B with pin
 acc. to DIN 1810-B 45-50 mm } **GZ349053**
- Verschluss-Schraube M18x1,5 x 20; SW10
 Screw plug M18x1.5 x 20; SW10 } **GZ359313**

Product Finder

v_c / f_z

M

MF

UNC
UN, UNS

UNF
UNEF

G, Rp

NPT, NPTF
Rc, W

BSW, BSF

Pg

EG (STI)
SELF-LOCK

Tr

Zubehör
Accessories

Tech. Info

BGF

ZBGF

GSF

GF

GF-KEG

ZGF

ZIRK-GF

Gigant

MoSys

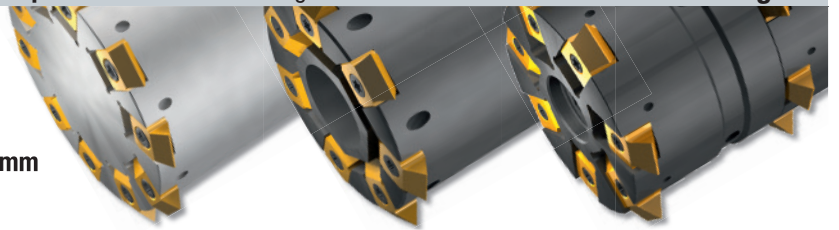

14

Für große Abmessungen ab Gewindedurchmesser 64 mm
For large thread sizes, from thread diameter 64 mm

Gigant-ic

Gigant sprinter

DIN 69871 AD/B		Z4 - Z7		Z10				
$\varnothing D_{min.}$ mm	l_1	l_5	$\varnothing d_1$	SK	$\varnothing d_5$	Z (Inserts)	Gigant-ic Gr. 14-IKZN	Gigant sprinter Gr. 14-IKZN
64	253	150	52,55	SK 40	41	4	GZ343014 ●	
64	286	150	52,55	SK 50	41	4	GZ344014 ●	
64	298	195	52,55	SK 40	41	4	GZ343114 ●	
64	331	195	52,55	SK 50	41	4	GZ344114 ●	
80	308	170	66,55	SK 50	55	7	GZ344024 ●	
80	398	260	66,55	SK 50	55	7	GZ344124 ●	
115	489	360	92	SK 50	80	10		GZ344204 ●

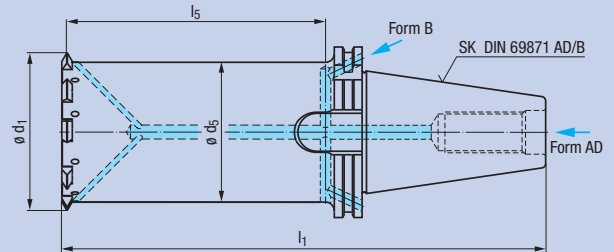

Gigant modular

DIN 138		Z7				
$\varnothing D_{min.}$ mm	l_6	$\varnothing d_1$	$\varnothing d_5$	$\varnothing D_3$	Z (Inserts)	Gigant modular Gr. 14-IKZN
80	47	71,5	60	27	7	GZ352004 ●

Nur einzeln einsetzbar
Can only be used individually

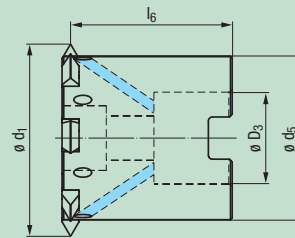

Gigant modular sprinter

MF		Z7				
$\varnothing D_{min.}$ mm	l_7	$\varnothing d_1$	$\varnothing d_5$	G_1	Z (Inserts)	Gigant modular sprinter Gr. 14-IKZN
80	60	71,5	60	M24 x 1,5	7	GZ353004 ●

Je nach Anwendung empfehlen wir, max. 3 Gigant modular sprinter miteinander zu kombinieren
Depending on the application, we recommend to combine up to a maximum of 3 Gigant modular sprinter

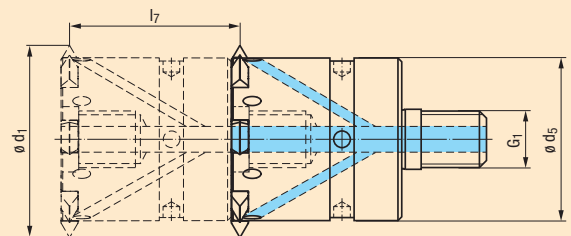

Die Innensechskant-Schraube zum stirnseitigen Verschließen der Kühlmittel-Bohrung ist im Lieferumfang enthalten
The hexagon socket screw to close the coolant hole on the face side is included with the delivery

Das Maß l_7 muss ein Vielfaches der Steigung P des herzustellenden Gewindes sein
The measurement l_7 must be a multiple of the pitch P of the thread to be produced

Fräsringe zum Entfernen des unvollständigen Ganges siehe Seite 442
Milling rings for removal of the incomplete thread, see page 442

Aufnahmen und Verlängerungen für Gigant modular und Gigant modular sprinter siehe Seite 444 - 445
Holders and extensions for Gigant modular and Gigant modular sprinter, see pages 444 - 445

14

4-Zahnwendeplatten für Steigungsbereich bis 8 mm (3,5 Gg/1")
 4-tooth indexable inserts for a pitch range up to 8 mm (3.5 tpi)

	HM RH + LH		
	Beschichtung · Coating	TIN	TIALN-T4
Einsatzgebiete – Material Range of application – material ▶ 328	P 1.1-5.1 M 1.1-4.1 K 1.1-4.2 N 1.1-4.4 S 1.1-3		
P mm P Gg/1" (tpi) b h	HM-WP-Z4 Gr. 14 TIN	HM-WP-Z4 Gr. 14 TIALN-T4	

<h2>M, MF, UN</h2> DIN 13, ANSI B1.1			
1,5 - 3 16 - 9 12,5 19 3 - 6 9 - 4 12,5 19	GF643405.9514 ● GF643407.9514 ● GF643405.9518 ● GF643407.9518 ●		

<h2>M, MF</h2> DIN 13			new
5,5 12,5 19 6 12,5 19			GF641407.9709 ● GF641407.9523 ●

<h2>G (BSP), BSW, BSF, W</h2> DIN EN ISO 228, BS 84			
(2,309) 11 (3.5 - 12) 12,5 19	GF643405.9550 ● GF643407.9550 ●		

<h2>Tr</h2> DIN 103			new
6 12,5 19 $\varnothing D_{min.} = d_1 + 61$ 8 12,5 19 $\varnothing D_{min.} = d_1 + 84$			GF643407.9605 ● GF643407.9736 ●

Andere Ausführungen auf Anfrage, z.B.
 Other designs upon request, e.g.



Zubehör
 Accessories

- Ersatzschraube M5 x 15; Torx T20
 Spare screw M5 x 15; Torx T20 } **GZ349014**
- Schraubendreher Torx T20
 Screw driver Torx T20 } **GZ349024**
- Drehmoment-Schraubendreher Torx T20
 Torque screw driver Torx T20 } **GZ349044**
- Hakenschlüssel mit Zapfen
 nach DIN 1810-B 58-62 mm
 Hook wrench type B with pin
 acc. to DIN 1810-B 58-62 mm } **GZ349054**
- Verschluss-Schraube M24x1,5 x 25; SW12
 Screw plug M24x1.5 x 25; SW12 } **GZ359314**

Product Finder

v_c / f_z

M

MF

UNC
UN, UNS

UNF
UNEF

G, Rp

NPT, NPTF
Rc, W

BSW, BSF

Pg

EG (STI)
SELF-LOCK

Tr

Zubehör
Accessories

Tech. Info

BGF

ZBGF

GSF

GF

GF-KEG

ZGF

ZIRK-GF

Gigant

MoSys

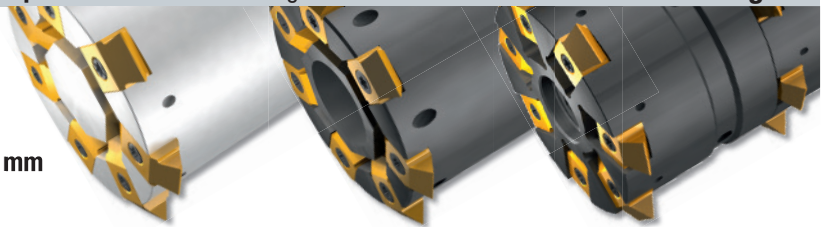

Product Finder

v_c / f_z

M

MF

UNC
UN, UNS

UNF
UNEF

G, Rp

NPT, NPTF
Rc, W

BSW, BSF

Pg

EG (STI)
SELF-LOCK

Tr

Zubehör
Accessories

Tech. Info

BGF

ZBGF

GSF

GF

GF-KEG

ZGF

ZIRK-GF

Gigant

MoSys

15

Für große Abmessungen ab Gewindedurchmesser 115 mm
For large thread sizes, from thread diameter 115 mm

Gigant-ic

DIN 69871



Z7



$\emptyset D_{min.}$ mm	l_1	l_5	$\emptyset d_1$	SK	$\emptyset d_5$	Z (Inserts)	Gigant-ic Gr. 15-IKZN
115	341	204	92	SK 50	76	7	GZ344035 ●
115	497	360	92	SK 50	76	7	GZ344045 ●

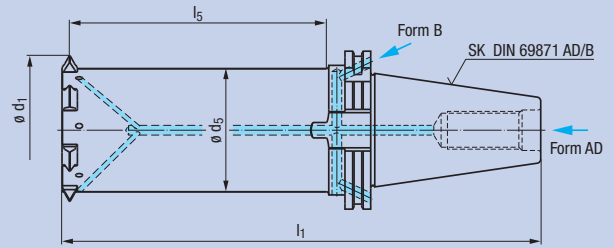

Gigant modular

DIN 138



Z7



$\emptyset D_{min.}$ mm	l_6	$\emptyset d_1$	$\emptyset d_5$	$\emptyset D_3$	Z (Inserts)	Gigant modular Gr. 15-IKZN
115	55	94	78	32	7	GZ352005 ●

Nur einzeln einsetzbar
Can only be used individually

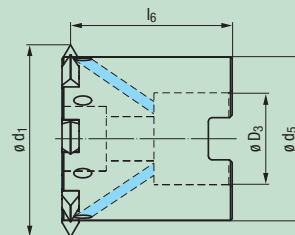

Gigant modular sprinter

MF



Z7



$\emptyset D_{min.}$ mm	l_7	$\emptyset d_1$	$\emptyset d_5$	G_1	Z (Inserts)	Gigant modular sprinter Gr. 15-IKZN
115	60	94	78	M24 x 1,5	7	GZ353005 ●

Je nach Anwendung empfehlen wir, max. 3 Gigant modular sprinter miteinander zu kombinieren
Depending on the application, we recommend to combine up to a maximum of 3 Gigant modular sprinter

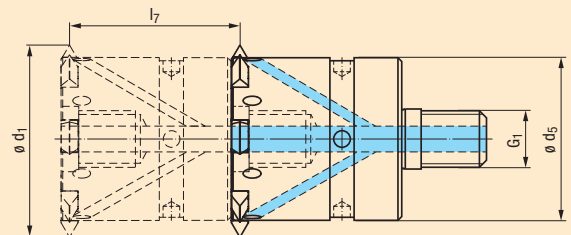

Die Innensechskant-Schraube zum stirnseitigen Verschließen der Kühlmittel-Bohrung ist im Lieferumfang enthalten
The hexagon socket screw to close the coolant hole on the face side is included with the delivery

Das Maß l_7 muss ein Vielfaches der Steigung P des herzustellenden Gewindes sein
The measurement l_7 must be a multiple of the pitch P of the thread to be produced



Aufnahmen und Verlängerungen für Gigant modular und Gigant modular sprinter siehe Seite 444 - 445
Holders and extensions for Gigant modular and Gigant modular sprinter, see pages 444 - 445

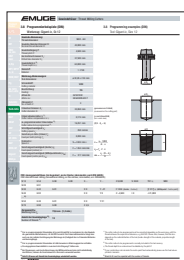



Programmierbeispiel für Gewindefräser
Typ Gigant siehe Seite 470

Programming example for thread milling cutters type Gigant, see page 470

15

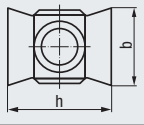
4-Zahnwendeplatten für Steigungsbereich bis 12 mm (4 Gg/1") 4-tooth indexable inserts for a pitch range up to 12 mm (4 tpi)

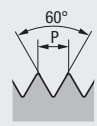
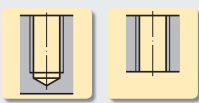
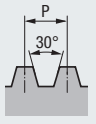
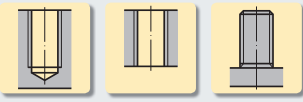
				HM RH + LH					
Einsatzgebiete – Material Range of application – material				Beschichtung · Coating		TIN		TIALN-T4	
P mm P Gg/1" (tpi) b h				P 1.1-5.1 M 1.1-4.1 K 1.1-4.2 N 1.1-4.4 S 1.1-3		HM-WP-Z4 Gr. 15 TIN		HM-WP-Z4 Gr. 15 TIALN-T4	
<h3>M, MF, UN</h3> DIN 13, ANSI B1.1									
1,5 - 6 16 - 4 14,3 28,58 6 - 8 4 14,3 28,58				GF643505.9514 ● GF643507.9514 ● GF643505.9523 ● GF643507.9523 ●					
<h3>Tr</h3> DIN 103								new	
10 14,3 28,58 $\varnothing D_{min.} = d_1 + 101$ 12 14,3 28,58 $\varnothing D_{min.} = d_1 + 122$						GF643507.9748 ● GF643507.9749 ●			

Andere Ausführungen auf Anfrage, z.B.
Other designs upon request, e.g.



Zubehör
Accessories

- 
 Ersatzschraube M5 x 18; Torx T20
Spare screw M5 x 18; Torx T20
- 
 Schraubendreher Torx T20
Screw driver Torx T20
- 
 Drehmoment-Schraubendreher Torx T20
Torque screw driver Torx T20
- 
 Hakenschlüssel mit Zapfen nach DIN 1810-B 68-75 mm
Hook wrench type B with pin acc. to DIN 1810-B 68-75 mm
- 
 Verschluss-Schraube M24x1,5 x 25; SW12
Screw plug M24x1.5 x 25; SW12

Product Finder

v_c / f_z

M

MF

UNC UN, UNS

UNF UNEF

G, Rp

NPT, NPTF Rc, W

BSW, BSF

Pg

EG (STI) SELF-LOCK

Tr

Zubehör Accessories

Tech. Info

BGF

ZBGF

GSF

GF

GF-KEG

ZGF

ZIRK-GF

Gigant

MoSys



- Product Finder
- v_c / f_z
- M
- MF
- UNC
UN, UNS
- UNF
UNEF
- G, Rp
- NPT, NPTF
Rc, W
- BSW, BSF
- Pg
- EG (STI)
SELF-LOCK
- Tr
- Zubehör
Accessories
- Tech. Info
- BGF
- ZBGF
- GSF
- GF
- GF-KEG
- ZGF
- ZIRK-GF
- Gigant
- MoSys

10-14

Fräsringe zum Entfernen des unvollständigen Ganges
Milling rings for removal of the incomplete thread

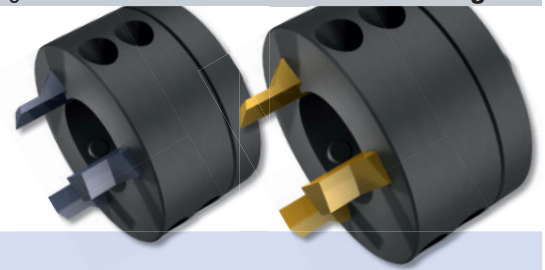

Gigant-ic

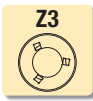

new	Größe Size	$\varnothing d_1$	$\varnothing D_5 / d_5$	l_6	l_7	$\varnothing d_6$	Z (Inserts)	
	10	20,5	15,9	18	23	33	3	GZ80FOC4.010040 ●
	11	23,85	19	18	22	37	3	GZ80GOC4.011040 ●
	12	32,85	24,5	22	24	47	3	GZ80HOC4.012060 ●
	13	40,25	31	22	24	55	4	GZ80IOC4.013060 ●
	14	52,55	41	22	23	65	4	GZ80JOC4.014060 ●

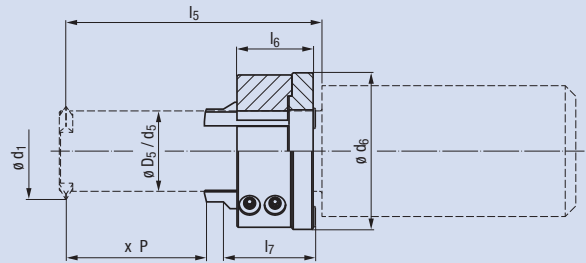

Das Maß „x P“ muss ein Vielfaches der Steigung P des herzustellenden Gewindes sein
The measurement "x P" must be a multiple of the pitch P of the thread to be produced

Die Nutztiefe l_5 des Zirkular-Gewindefräskörpers verringert sich um das Maß l_7
The usable depth l_5 of the circular thread milling body is reduced by dimension l_7

1-Zahn-Fräsplatten für Fräsringe

1-tooth milling inserts for milling rings

HM RH + LH

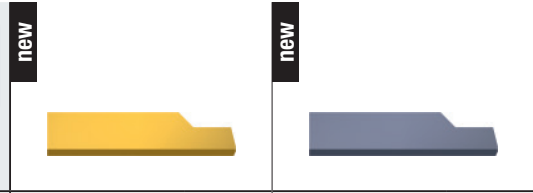

Einsatzgebiete – Material Range of application – material			Beschichtung · Coating	
Range of application – material » 328			TIN	TIALN-T4
<p>P 1.1-5.1 M 1.1-4.1 K 1.1-4.2 N 1.1-4.4 S 1.1-3</p>			HM-FP-Z1	HM-FP-Z1
Größe Size	l_8	t	TIN	TIALN-T4
10	20	4	GF663005 ●	GF663007 ●
11	20	4	GF663105 ●	GF663107 ●
12	25	6	GF663205 ●	GF663207 ●
13	25	6	GF663305 ●	GF663307 ●
14	25	6	GF663405 ●	GF663407 ●



Product
Finder

v_c / f_z

M

MF

UNC
UN, UNS

UNF
UNEF

G, Rp

NPT, NPTF
Rc, W

BSW, BSF

Pg

EG (STI)
SELF-LOCK

Tr

Zubehör
Accessories

Tech. Info

BGF

ZBGF

GSF

GF

GF-KEG

ZGF

ZIRK-GF

Gigant

MoSys



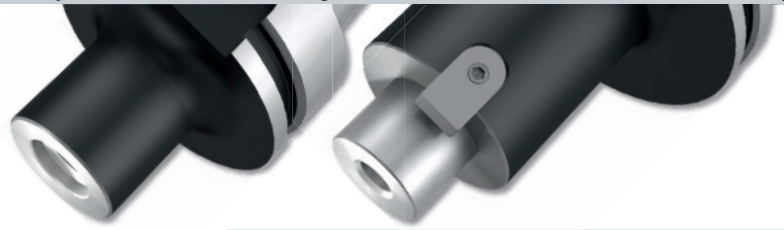

10-15

Aufnahmen für Gigant modular Holders for Gigant modular

HSK-A

DIN 69893-1



Größe Size	G ₁	∅ d ₅	l ₅	l _A	HSK	
10-12	M16	29	29	59	HSK-A63	GZ5391A4.116059 ●

Größe Size	∅ D ₃	∅ d ₅	l ₅	l ₃	l _A	HSK	
13	27	48	131	21	160	HSK-A63	GZ5391B4.270160 ●
14	27	60	131	21	160	HSK-A63	GZ5391B5.270160 ●
15	32	78	171	24	200	HSK-A63	GZ5391B4.320200 ●

DIN 138



SK (ISO)

DIN 69871



Größe Size	G ₁	∅ d ₅	l ₅	l _A	SK	
10-12	M16	29	11	36	SK 40	GZ5243A4.116036 ●
10-12	M16	29	11	36	SK 50	GZ5263A4.116036 ●

Größe Size	∅ D ₃	∅ d ₅	l ₅	l ₃	l _A	SK	
13	27	48	132	21	160	SK 50	GZ5263B4.270160 ●
14	27	60	132	21	160	SK 50	GZ5263B5.270160 ●
15	32	78	174	24	200	SK 50	GZ5263B4.320200 ●

DIN 138



HSS-Verlängerungen für Gigant modular HSS extensions for Gigant modular

∅32

DIN 1835 A



Größe Size	G ₁	∅ d ₅	l ₅	l ₁	∅ d ₂ h6	
10-12	M16	29,4	108	200	32	GZ5521A4.320108 ●

Zwischenadapter für Gigant modular Intermediate adapters for Gigant modular

M16



Größe Size	G ₁	∅ d ₅	l _A	SW (W/F)	G ₂	
10-12	M16	29	40	22	M16	GZ56E1A4.116040 ●
10-12	M16	29	90	22	M16	GZ56E1A4.116090 ●

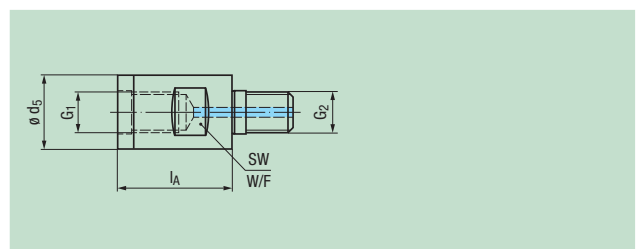
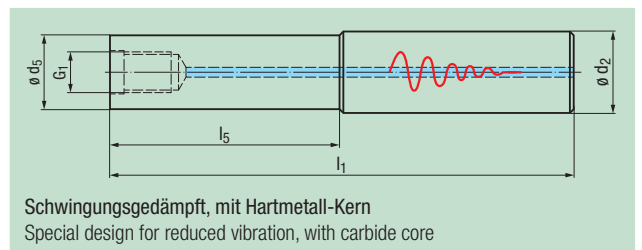
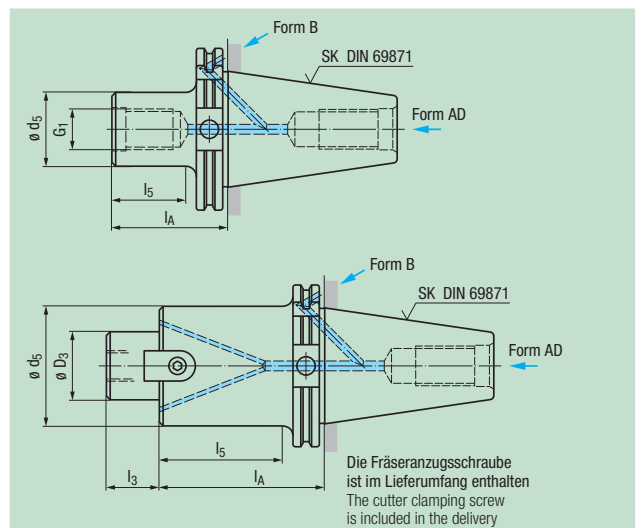
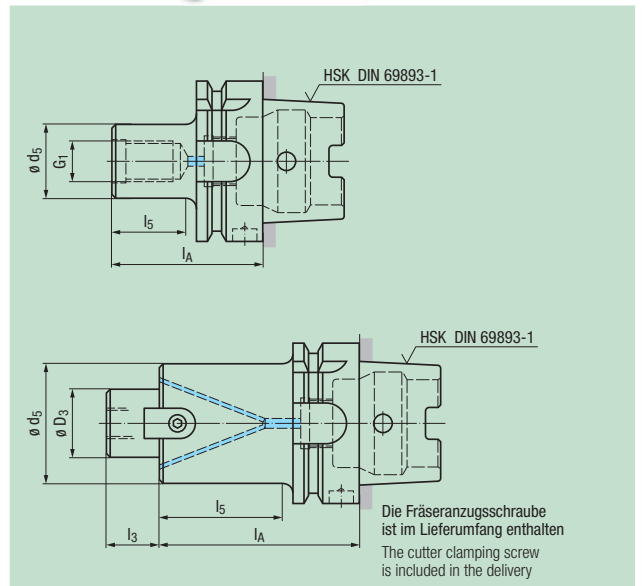

10-15



Aufnahmen für Gigant modular sprinter Holders for Gigant modular sprinter

HSK-A

DIN 69893-1

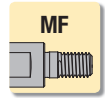

Größe Size	G ₁	∅ d ₅	l ₅	l _A	HSK		
10	M 8 x 1	22,15	10	45	HSK-A63	GZ7391AA.251010	●
11	M10 x 1	29,15	10	45	HSK-A63	GZ7391AB.276010	●
12	M12 x 1	37,65	12	45	HSK-A63	GZ7391AC.301012	●
13	M18 x 1,5	48	32	60	HSK-A63	GZ7391AD.390032	●
14	M24 x 1,5	60	40	80	HSK-A100	GZ73A1AE.452040	●
15	M24 x 1,5	78	45	76	HSK-A100	GZ73A1AF.452045	●

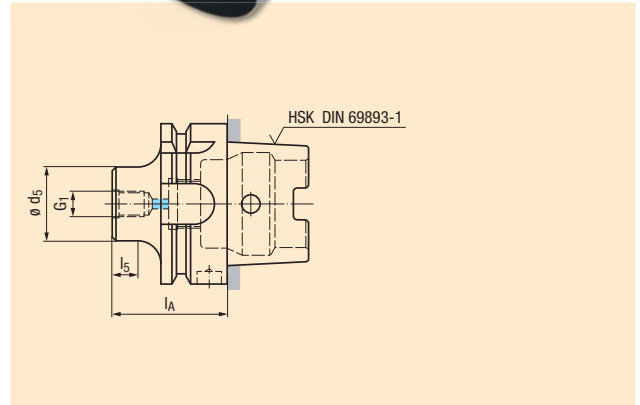

SK (ISO)

DIN 69871

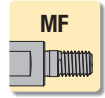

Größe Size	G ₁	∅ d ₅	l ₅	l _A	SK		
10	M 8 x 1	22,15	10	35	SK 40	GZ7243AA.251010	●
11	M10 x 1	29,15	10	35	SK 40	GZ7243AB.276010	●
12	M12 x 1	37,65	12	35	SK 40	GZ7243AC.301012	●
13	M18 x 1,5	48	15	37	SK 40	GZ7243AD.390015	●
14	M24 x 1,5	60	15	40	SK 50	GZ7263AE.452015	●
15	M24 x 1,5	78	20	45	SK 50	GZ7263AF.452020	●

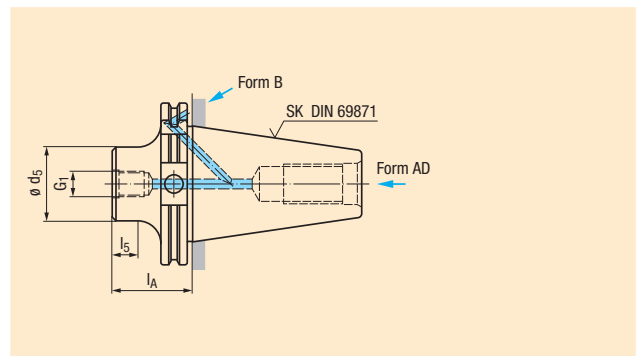

∅25-∅32

DIN 1835 B

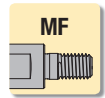

Größe Size	G ₁	∅ d ₅	l ₅	l ₁	∅ d ₂ h ₆		
10	M 8 x 1	22,15	10	68	25	GZ75D1AA.251010	●
11	M10 x 1	29,15	10	72	32	GZ7521AB.276010	●
12	M12 x 1	37,65	12	77	32	GZ7521AC.301012	●

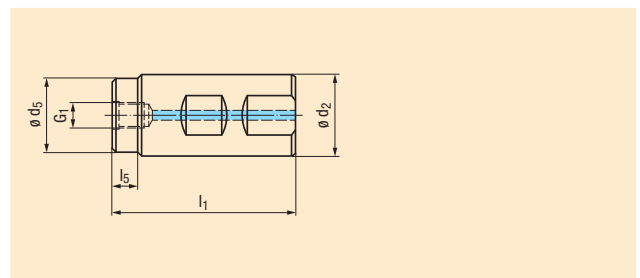

Product
Finder

v_c / f_z

M

MF

UNC
UN, UNS

UNF
UNEF

G, Rp

NPT, NPTF
Rc, W

BSW, BSF

Pg

EG (STI)
SELF-LOCK

Tr

Zubehör
Accessories

Tech. Info

BGF

ZBGF

GSF

GF

GF-KEG

ZGF

ZIRK-GF

Gigant

MoSys



- Product Finder
- v_c / f_z
- M
- MF
- UNC
UN, UNS
- UNF
UNEF
- G, Rp
- NPT, NPTF
Rc, W
- BSW, BSF
- Pg
- EG (STI)
SELF-LOCK
- Tr
- Zubehör
Accessories
- Tech. Info
- BGF
- ZBGF
- GSF
- GF
- GF-KEG
- ZGF
- ZIRK-GF
- Gigant
- MoSys

„MoSys“ gestattet vielseitige Plan- und Stufensenkoperationen!

In einer Aufspannung erzielen Sie folgende Vorteile:

- Geringe Anzahl an Werkzeugen
- Wenig Lagerplätze und Lagerkosten
- Kurze Bearbeitungszeiten

„MoSys“ erfüllt folgende Voraussetzungen:

- Einfache Montage
- Hohe Steifigkeit
- Hohe Maßgenauigkeit
- Modular aufgebaut und einsetzbar

„MoSys“ makes a large number of counterbore and stepped bore operations possible!

With just one clamping operation, you enjoy a number of advantages:

- Smaller tool quantities
- Fewer magazine places and reduced stocking costs
- Shorter machining times

„MoSys“ answers to the following requirements:

- Easy assembly
- High degree of rigidity
- High dimensional precision
- Modular construction for universal application

MoSys mit Vollhartmetall-Kopf

MoSys with solid carbide head

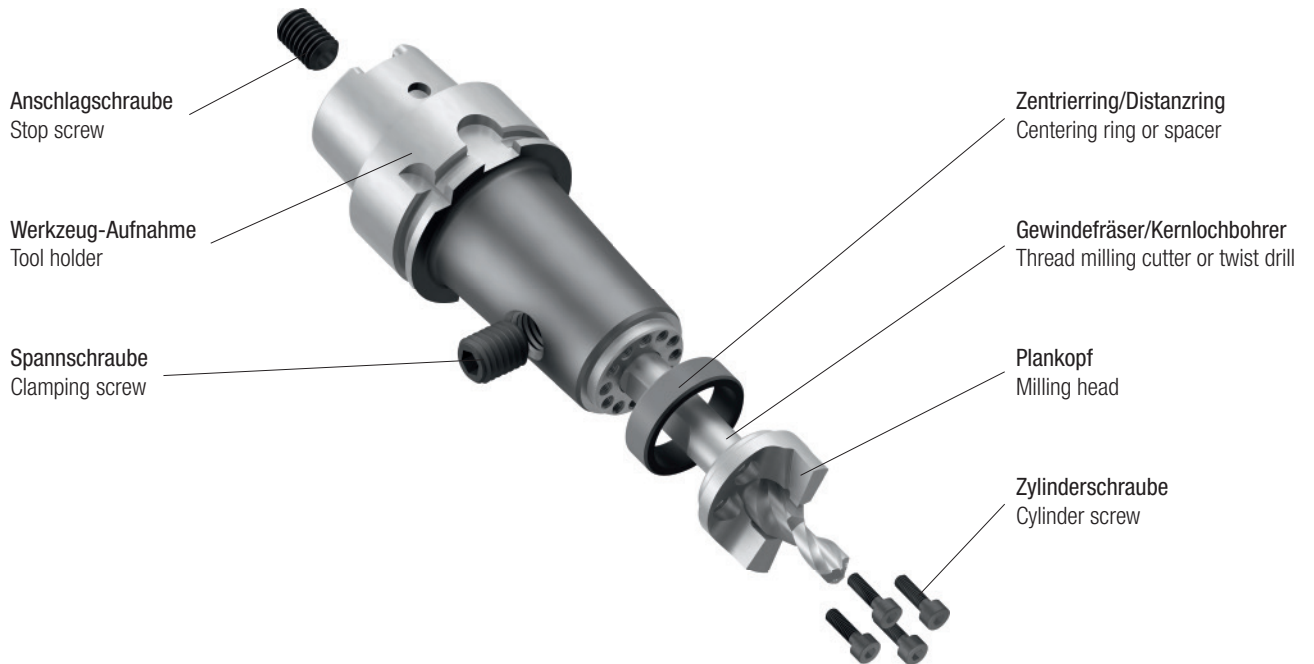

MoSys mit Wendeschneidplatten

MoSys with indexable inserts

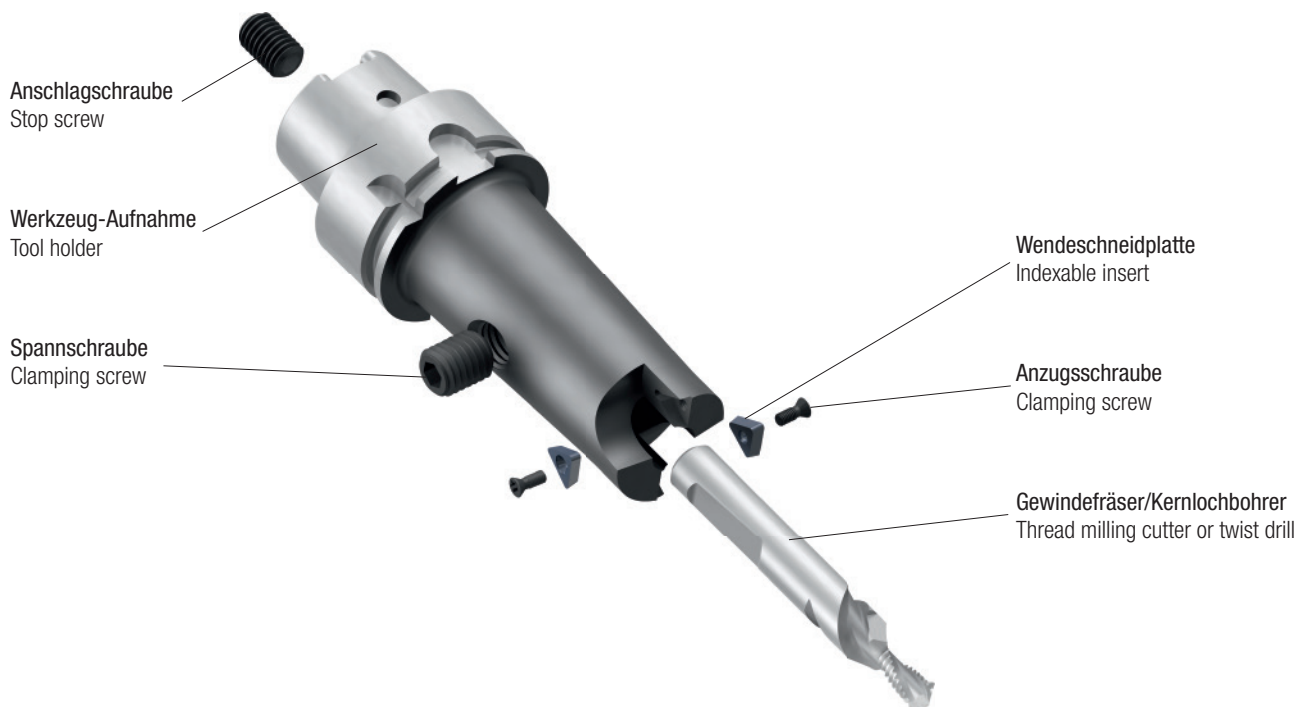

Steilkegelschäfte
ISO taper shanks



Kegel-Hohlschäfte
Hollow taper shanks



Anschluss für Plankopf
Connection for milling head



Anschluss für Wendeschneidplatten
Connection for indexable inserts

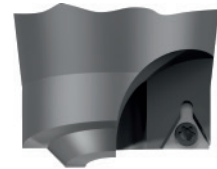
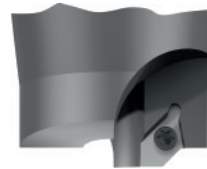

Zentrierring
Centering ring



Wendeschneidplatten zum Planen und Fasen
Indexable inserts for plane milling and chamfering



Wendeschneidplatten zum Planen
Indexable inserts for plane milling



Vollhartmetall-Planköpfe
Solid carbide milling heads

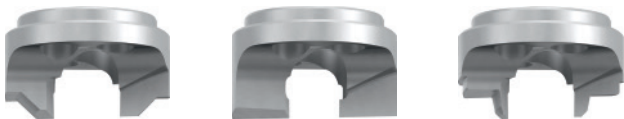

Gewindefräser oder Spiralbohrer
Thread milling cutters or twist drills



Product Finder

v_c / f_z

M

MF

UNC
UN, UNS

UNF
UNEF

G, Rp

NPT, NPTF
Rc, W

BSW, BSF

Pg

EG (STI)
SELF-LOCK

Tr

Zubehör
Accessories

Tech. Info

BGF

ZBGF

GSF

GF

GF-KEG

ZGF

ZIRK-GF

Gigant

MoSys



Product Finder

v_c / f_z

M

MF

UNC
UN, UNS

UNF
UNEF

G, Rp

NPT, NPTF
Rc, W

BSW, BSF

Pg

EG (STI)
SELF-LOCK

Tr

Zubehör
Accessories

Tech. Info

BGF

ZBGF

GSF

GF

GF-KEG

ZGF

ZIRK-GF

Gigant

MoSys



Zur Angebotsausarbeitung werden folgende Daten benötigt:

- Werkstückzeichnung mit evtl. Störkontur
- Maschinenseitige Aufnahme mit Kühlschmierstoff-Übergabe
- Detaillierte Senkkontur
- Herzustellende Gewindeabmessung einschließlich Gewindetiefe
- Bohrungsform (Durchgangsloch, Grundloch)
- Kernlochdurchmesser (falls vorhanden)
- Zu bearbeitender Werkstoff

For submitting an offer, we need the following information:

- Workpiece drawing with possible obstruction contours
- Shank connection on the machine side, with coolant supply
- Detailed countersink contour
- Size of the thread to be produced, including thread depth
- Type of hole (through hole or blind hole)
- Drilled hole diameter (if known)
- Workpiece material

Beispiel für Bearbeitung mit Vollhartmetall-Kopf

Example for machining with solid carbide head

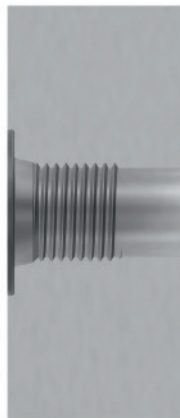
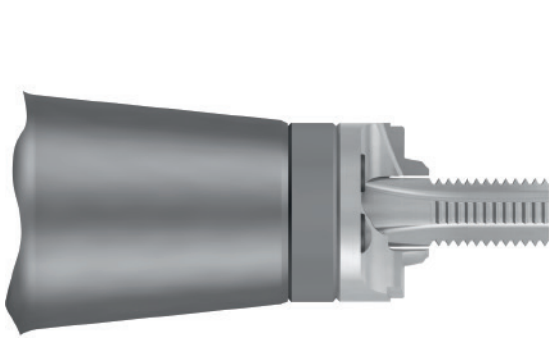

Beispiel für Bearbeitung mit Wendeschneidplatten

Example for machining with indexable inserts

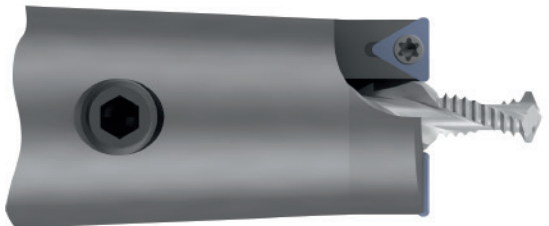

Technische Informationen

Technical Information

Seite · Page

3.1	Charakteristik und Vorteile des Gewindefräsens Characteristics and advantages of thread milling	450
3.2	EMUGE Gewindefräser-Typen Our EMUGE thread milling cutter types	451 - 455
3.3	Mögliche Modifikationen an Gewindefräsern Possible modifications on thread milling cutters	456 - 457
3.4	Berechnung der Schnittdaten Calculation of cutting data	458
3.5	Gewindefräsverfahren (Rechtsgewinde) Thread milling processes (right-hand thread)	459
3.6	Probleme, mögliche Ursachen und Abhilfen beim Gewindefräsen Problems, possible causes and solutions in thread milling	460 - 461
3.7	Programmierung Ein- und Ausfahren im Viertelkreis Programming of run-in and run-out in a quarter circle	462
3.8	Programmierbeispiele (DIN) Programming examples (DIN)	463 - 470
3.9	Technischer Fragebogen: Gewindefräsen Technical questionnaire: Thread milling	471 - 472

Product
Finder v_c / f_z

M

MF

UNC
UN, UNSUNF
UNEF

G, Rp

NPT, NPTF
Rc, W

BSW, BSF

Pg

EG (STI)
SELF-LOCK

Tr

Zubehör
Accessories

Tech. Info

BGF

ZBGF

GSF

GF

GF-KEG

ZGF

ZIRK-GF

Gigant

MoSys



Die Technischen Informationen der jeweiligen Kapitel dieses Kataloges sind in vielen Landessprachen auch als separate Druckerzeugnisse verfügbar. Bitte wenden Sie sich an den für Sie zuständigen Vertriebspartner.

The technical information complementing the various chapters of this catalogue is available also as a separate printed booklet in many different languages. Please speak to your usual sales contact.

Product Finder

v_c / f_z

M

MF

UNC
UN, UNS

UNF
UNEF

G, Rp

NPT, NPTF
Rc, W

BSW, BSF

Pg

EG (STI)
SELF-LOCK

Tr

Zubehör
Accessories

Tech. Info

BGF

ZBGF

GSF

GF

GF-KEG

ZGF

ZIRK-GF

Gigant

MoSys

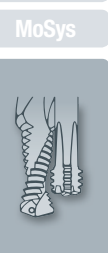

3.1 Charakteristik und Vorteile des Gewindefräsens

Gewindefräsen – eine Technologie, die Ihre Fertigungskosten spürbar senken kann!

Durch den verstärkten Einsatz der CNC-Technologie sind die Voraussetzungen für ein zukunftsorientiertes Verfahren zur Herstellung von Innen- und Außengewinden geschaffen worden.

Das Gewindefräsen lässt sich problemlos und prozesssicher praktizieren, wenn die CNC-Maschine über eine Steuerung mit 3D-Interpolation verfügt. Des Weiteren wird eine stabile und vibrationsfreie Werkzeug- und Werkstücksspannung sowie innere Kühlschmierstoff-Zufuhr (IKZ) benötigt.

Das Gewindefräsen ist in einer Vielzahl von Anwendungsfällen eine sinnvolle Alternative zum Gewindeschneiden oder Gewindeformen mit folgenden Vorteilen:

- Kurze Fertigungszeiten
- Hohe Prozesssicherheit
- Sehr gute Oberflächenqualität
- Verschiedene Bearbeitungsfunktionen mit einem Werkzeug
- Nutzbare Gewindetiefe bis zum Bohrungsgrund
- Keine hochwertigen Schmierstoffe notwendig
- Keine Spanprobleme, da nur kurze Frässpäne erzeugt werden
- Kein axiales Verschneiden (Vorweite) der Gewinde
- Universeller Einsatz in den verschiedensten Werkstoffen bis ca. 60 HRC
- Grund- und Durchgangslochgewinde mit einem Werkzeug
- Unabhängige Gewindeherstellung bezüglich Abmessung und Toleranz
- Ein Werkzeug für Rechts- und Linksgewinde
- Geringe Schnittkräfte
- Auch für dünnwandige Werkstücke geeignet

Sollten Sie keine oder nur wenig Erfahrung bei der Programmierung der Steuerung haben, stehen Ihnen unsere Techniker gerne mit Rat und Tat zur Seite. Wir sind auch gerne bereit, Sie hausintern oder vor Ort an konkreten Bearbeitungsbeispielen zu schulen.

Bitte sprechen Sie unsere Vertriebsmitarbeiter an.

3.1 Characteristics and advantages of thread milling

Thread milling – A technology which can reduce your production costs considerably!

With the more and more widespread use of CNC technology, the basic conditions for a future-oriented technique of producing internal and external threads have been created.

Thread milling can be practiced without any trouble and with a high degree of process safety if your CNC machine is provided with a control for 3D-interpolation. In addition to that, you need stable and vibration-free tool and workpiece clamping, and internal coolant supply.

Thread milling is, in a multitude of application cases, a highly recommendable alternative to tapping or cold-forming of threads, with the following advantages:

- Short production times
- High degree of process safety
- Very good surface quality
- Combination of different machining jobs with one tool
- Usable thread depth down to the very bottom of the hole
- No expensive lubricants are needed
- No chip problems, since only short milling chips are created
- No axial miscutting (overcut) of the thread
- Universal use in the most different materials up to approx. 60 HRC
- Blind hole and through hole threads produced with one tool
- Thread production independent of thread size and tolerance
- One tool only for right-hand and left-hand threads
- Low cutting forces
- Suitable also for thin-walled components

In case you should have little or no experience with the programming of the control, our technicians will be happy to help you by word and deed. We are also ready, at any time, to provide in-house or on-location training for you with practical machining examples.

Please contact our sales personnel.

3.2 EMUGE Gewindefräser-Typen

3.2 Our EMUGE thread milling cutter types

BGF

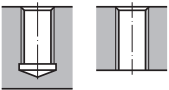
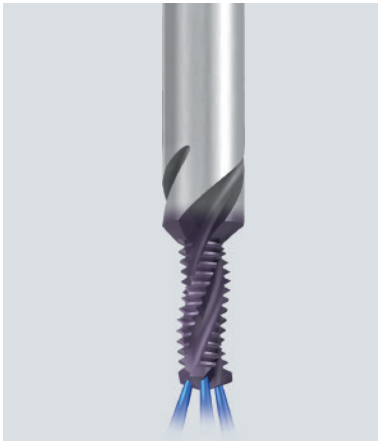
**Vollhartmetall-Bohrgewindefräser**

- Zur Herstellung von Innengewinden
- Für die Komplettbearbeitung von Kernloch, Senkfase und Gewinde in einem Arbeitsgang
- Abmessungsbezogenes Werkzeug mit korrigiertem Gewindeprofil

Ausführungen:

- 2-nutig: Bearbeitung ins volle Material
 3-nutig: Bearbeitung in vorgegossene Kernlöcher und ins volle Material
 4-nutig: Kürzere Bearbeitungszeiten (nur Gusseisen und Aluminium-Guss, kurzspanend)

Solid carbide drill thread mills

- For the production of internal threads
- For the complete machining of thread hole, chamfer and thread in one work process
- Tool for one single thread size with corrected thread profile

Designs:

- 2-fluted: For work in solid material
 3-fluted: For work in pre-cast thread holes and in solid material
 4-fluted: For shorter machining times (only for cast iron and cast aluminium, short-chipping)

ZBGF

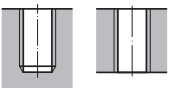
**Vollhartmetall-Zirkular-Bohrgewindefräser**

- Zur Herstellung von Innengewinden
- Für die Bearbeitung von Kernloch und Gewinde in einem Arbeitsgang
- Abmessungsübergreifendes und steigungsgelinktes Werkzeug mit korrigiertem Gewindeprofil

Ausführungen:

- ZBGF-T: Für Gewindetiefen bis 3 x D in Aluminium und Grauguss
 ZBGF-H: Für die Hartbearbeitung ab 44 HRC
 ZBGF-W: Für die verschiedensten Werkstoffe bis 44 HRC

Solid carbide circular drill thread mills

- For the production of internal threads
- For the machining of thread hole and thread in one work process
- Tool for different thread sizes but for one pitch only, with corrected thread profile

Designs:

- ZBGF-T: For thread depths up to 3 x D in aluminium and cast iron
 ZBGF-H: For hard machining from 44 HRC
 ZBGF-W: For the most different materials up to 44 HRC

GSF

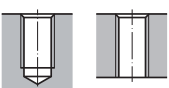
**Vollhartmetall-Gewindefräser mit Senkfase**

- Zur Herstellung von Innengewinden
- Für die Bearbeitung von Senkfase und Gewinde in einem Arbeitsgang
- Abmessungsbezogenes Werkzeug mit korrigiertem Gewindeprofil
- Voraussetzung ist ein vorgearbeitetes Kernloch

Solid carbide thread milling cutters with countersinking step

- For the production of internal threads
- For the machining of chamfer and thread in one work process
- Tool for one single thread size, with corrected thread profile
- A ready prepared thread hole is necessary

Product
Finder v_c / f_z

M

MF

UNC
UN, UNSUNF
UNEF

G, Rp

NPT, NPTF
Rc, W

BSW, BSF

Pg

EG (STI)
SELF-LOCK

Tr

Zubehör
Accessories

Tech. Info

BGF

ZBGF

GSF

GF

GF-KEG

ZGF

ZIRK-GF

Gigant

MoSys



Product Finder

3.2 EMUGE Gewindefräser-Typen

3.2 Our EMUGE thread milling cutter types

v_c / f_z

M

GSF-Z

MF

UNC
UN, UNS

UNF
UNEF

G, Rp

NPT, NPTF
Rc, W

BSW, BSF

Pg

EG (STI)
SELF-LOCK

Tr

Zubehör
Accessories

Tech. Info



Vollhartmetall-Gewindefräser mit Senkfase

- Zur Herstellung von Innengewinden
- Für die Bearbeitung von Senkfase und Gewinde in einem Arbeitsgang
- Abmessungsbezogenes Werkzeug mit korrigiertem Gewindeprofil
- Höhere Nutenzahl im Vergleich zum Typ GSF
- Optimierte Schneidengeometrie
- Voraussetzung ist ein vorgearbeitetes Kernloch

Solid carbide thread milling cutters with countersinking step

- For the production of internal threads
- For the machining of chamfer and thread in one work process
- Tool for one single thread size, with corrected thread profile
- Increased number of flutes compared with type GSF
- Optimised cutting geometry
- A ready prepared thread hole is necessary

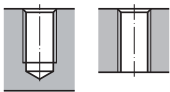

GF

BGF

ZBGF

GSF

GF

GF-KEG

ZGF

ZIRK-GF

Gigant

MoSys

Zubehör
Accessories

Tech. Info



Vollhartmetall-Gewindefräser

- Zur Herstellung von Innen- und Außengewinden
- Abmessungsübergreifendes Werkzeug mit Standard-Gewindeprofil (steigungsgebunden)
- Voraussetzung ist ein vorgearbeitetes Kernloch ggf. mit einer Ansenkung
- Um größere Profilüberfräsungen bei Innengewinden zu vermeiden, sollte der Fräserdurchmesser nicht größer als $\frac{2}{3}$ (bei Feingewinden $\frac{3}{4}$) des herzustellenden Gewindes sein
- Bei Außengewinden sollte der Fräserdurchmesser den herzustellenden Gewindedurchmesser nicht überschreiten

Solid carbide thread milling cutters

- For the production of internal and external threads
- Tool for different thread sizes with standard thread profile (but for one pitch only)
- A ready prepared thread hole is necessary, including chamfer if needed
- In order to avoid serious profile deviation in internal threads, the cutter diameter should not exceed $\frac{2}{3}$ (with fine threads, $\frac{3}{4}$) of the thread to be produced
- With external threads, the cutter diameter should not exceed the diameter of the thread to be produced

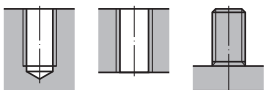

GF-Z

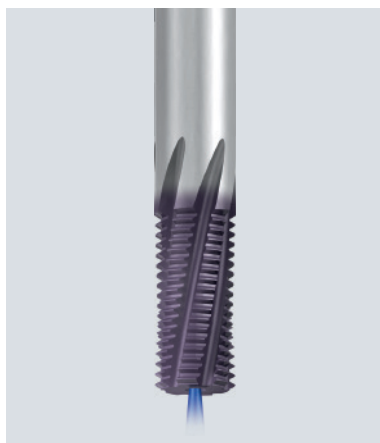

Vollhartmetall-Gewindefräser

- Zur Herstellung von Innengewinden
- Abmessungsübergreifendes Werkzeug mit Standard-Gewindeprofil (steigungsgebunden)
- Höhere Nutenzahl im Vergleich zum Typ GF
- Optimierte Schneidengeometrie
- Voraussetzung ist ein vorgearbeitetes Kernloch ggf. mit einer Ansenkung
- Um größere Profilüberfräsungen bei Innengewinden zu vermeiden, sollte der Fräserdurchmesser nicht größer als $\frac{2}{3}$ (bei Feingewinden $\frac{3}{4}$) des herzustellenden Gewindes sein

Solid carbide thread milling cutters

- For the production of internal threads
- Tool for different thread sizes with standard thread profile (but for one pitch only)
- Increased number of flutes compared with type GF
- Optimised cutting geometry
- A ready prepared thread hole is necessary, including chamfer if needed
- In order to avoid serious profile deviation in internal threads, the cutter diameter should not exceed $\frac{2}{3}$ (with fine threads, $\frac{3}{4}$) of the thread to be produced

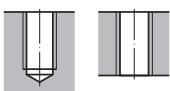

3.2 EMUGE Gewindefräser-Typen

3.2 Our EMUGE thread milling cutter types

GF-Vario-Z

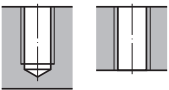
**Vollhartmetall-Gewindefräser variabel**

- Zur Herstellung von Innengewinden
- Abmessungsübergreifendes und steigungsgebundenes Werkzeug mit korrigiertem Gewindeprofil
- Hohe Nutenzahl
- Optimierte Schneidengeometrie
- Voraussetzung ist ein vorgearbeitetes Kernloch ggf. mit einer Ansenkung

Solid carbide thread milling cutters, variable

- For the production of internal threads
- Tool for different thread sizes, but for one pitch only, with corrected thread profile
- Large number of flutes
- Optimised cutting geometry
- A ready prepared thread hole is necessary, including chamfer if needed

GF-H

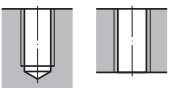
**Vollhartmetall-Gewindefräser für die Hartbearbeitung**

- Zur Herstellung von Innengewinden
- Abmessungsbezogenes Werkzeug mit korrigiertem Gewindeprofil
- Voraussetzung ist ein vorgearbeitetes Kernloch ggf. mit einer Ansenkung

Solid carbide thread milling cutters for hard machining

- For the production of internal threads
- Tool for one single thread size, with corrected thread profile
- A ready prepared thread hole is necessary, including chamfer if needed

GF-KEG

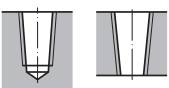
**Vollhartmetall-Gewindefräser für kegelige Gewinde**

- Zur Herstellung von kegeligen Innengewinden
- Abmessungs- bzw. steigungsgebundenes Werkzeug mit korrigiertem Gewindeprofil
- Voraussetzung ist ein zylindrisch oder besser ein kegelig vorgebohrtes Kernloch ggf. mit einer Ansenkung

Solid carbide thread milling cutters for tapered threads

- For the production of tapered internal threads
- Tool for one single thread size, resp. for one pitch only, with corrected thread profile
- A ready prepared cylindrical, or even better, tapered, thread hole is necessary, including chamfer if needed

Product
Finder v_c / f_z

M

MF

UNC
UN, UNSUNF
UNEF

G, Rp

NPT, NPTF
Rc, W

BSW, BSF

Pg

EG (STI)
SELF-LOCK

Tr

Zubehör
Accessories

Tech. Info

BGF

ZBGF

GSF

GF

GF-KEG

ZGF

ZIRK-GF

Gigant

MoSys



- Product Finder
- v_c / f_z
- M
- MF
- UNC
UN, UNS
- UNF
UNEF
- G, Rp
- NPT, NPTF
Rc, W
- BSW, BSF
- Pg
- EG (STI)
SELF-LOCK
- Tr
- Zubehör
Accessories

3.2 EMUGE Gewindefräser-Typen

3.2 Our EMUGE thread milling cutter types

ZGF

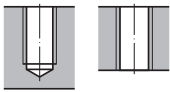

Vollhartmetall-Zirkulargewindefräser

- Zur Herstellung von Innengewinden ab M1
- **ZGF**
Abmessungs- und steigungsübergreifendes Werkzeug mit korrigiertem Gewindeprofil
- **ZGF-S-CUT**
Abmessungsbezogenes Werkzeug mit korrigiertem Gewindeprofil
- **ZGF-HCUT**
Abmessungsbezogenes Werkzeug mit korrigiertem Gewindeprofil
- Voraussetzung ist ein vorgearbeitetes Kernloch ggf. mit einer Ansenkung

Solid carbide circular thread milling cutters

- For the production of internal threads from M1
- **ZGF**
Tool for different thread sizes and pitches, with corrected thread profile
- **ZGF-S-CUT**
Tool for one single thread size, with corrected thread profile
- **ZGF-HCUT**
Tool for one single thread size, with corrected thread profile
- A ready prepared thread hole is necessary, including chamfer if needed

ZIRK-GF

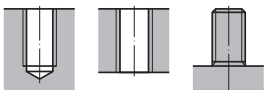

Zirkular-Gewindefräskörper

- Zur Herstellung von Innen- und Außengewinden
- Mit einer oder zwei Mehrzahnplatten
- Abmessungsübergreifendes und steigungsgebundenes Werkzeug
- Voraussetzung ist ein vorgearbeitetes Kernloch ggf. mit einer Ansenkung
- Um größere Profilüberfräsungen bei Innengewinden zu vermeiden, sollte der Fräserdurchmesser nicht größer als $\frac{2}{3}$ (bei Feingewinden $\frac{3}{4}$) des herzustellenden Gewindes sein

Circular thread milling bodies

- For the production of internal and external threads
- With one or two multi-tooth inserts
- Tool for different thread sizes, but for one pitch only
- A ready prepared thread hole is necessary, including chamfer if needed
- In order to avoid serious profile deviation in internal threads, the cutter diameter should not exceed $\frac{2}{3}$ (with fine threads, $\frac{3}{4}$) of the thread to be produced

ZIRK-GF

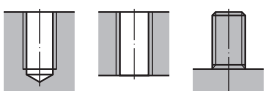

Zirkular-Gewindefräskörper

- Zur Herstellung von Innen- und Außengewinden
- Mit einer Einstechwendeplatte „3-Zahn“
- Abmessungs- und steigungsübergreifendes Werkzeug
- Voraussetzung ist ein vorgearbeitetes Kernloch ggf. mit einer Ansenkung
- Um größere Profilüberfräsungen bei Innengewinden zu vermeiden, sollte der Fräserdurchmesser nicht größer als $\frac{2}{3}$ (bei Feingewinden $\frac{3}{4}$) des herzustellenden Gewindes sein

Circular thread milling bodies

- For the production of internal and external threads
- With one infeed indexable insert, “3-tooth” design
- Tool for different thread sizes and pitches
- A ready prepared thread hole is necessary, including chamfer if needed
- In order to avoid serious profile deviation in internal threads, the cutter diameter should not exceed $\frac{2}{3}$ (with fine threads, $\frac{3}{4}$) of the thread to be produced

3.2 EMUGE Gewindefräser-Typen

3.2 Our EMUGE thread milling cutter types

Gigant

**Zirkular-Gewindefräskörper**

- Zur Herstellung von großen Innen- und Außengewinden
- Mit bis zu zehn 4-Zahn-Wendeplatten (steigungsübergreifend)
- Abmessungs- und steigungsübergreifendes Werkzeug
- Voraussetzung ist ein vorgearbeitetes Kernloch ggf. mit einer Ansenkung

Circular thread milling bodies

- For the production of large internal and external threads
- With up to ten 4-tooth indexable inserts (independent of pitch)
- Tool for different thread sizes and pitches
- A ready prepared thread hole is necessary, including chamfer if needed

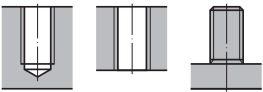
Product
Finder v_c / f_z

M

MF

UNC
UN, UNSUNF
UNEF

G, Rp

NPT, NPTF
Rc, W

BSW, BSF

Pg

EG (STI)
SELF-LOCK

Tr

Zubehör
Accessories

Tech. Info

BGF

ZBGF

GSF

GF

GF-KEG

ZGF

ZIRK-GF

Gigant

MoSys



- Product Finder
- v_c / f_z
- M
- MF
- UNC
UN, UNS
- UNF
UNEF
- G, Rp
- NPT, NPTF
Rc, W
- BSW, BSF
- Pg
- EG (STI)
SELF-LOCK
- Tr
- Zubehör
Accessories

3.3 Mögliche Modifikationen an Gewindefräsern

3.3 Possible modifications on thread milling cutters

Stirrfase (ohne oder mit Stirnschnitt)

Face chamfer (with or without cutting face)

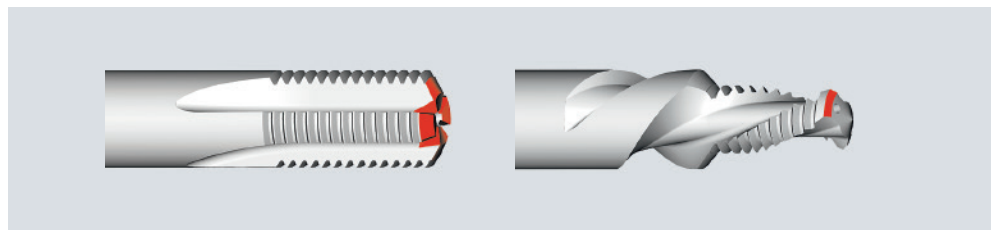

Geeignet für:

- Alle Typen GF und GSF
- Alle Typen BGF (Stirrfase am Bohrteil)

Suitable for:

- All types GF and GSF
- All types BGF (face chamfer on the drilling part)

Bemerkung:

- Stirrfase für zirkulares Anfasen des Kernloches
- Zusätzlicher Stirnschnitt für zirkulares Planfräsen

Note:

- Face chamfer for circular chamfering of the thread hole
- Additional cutting face for circular face milling

Tech. Info

Unvollständigen Gang entfernen

Removal of incomplete thread

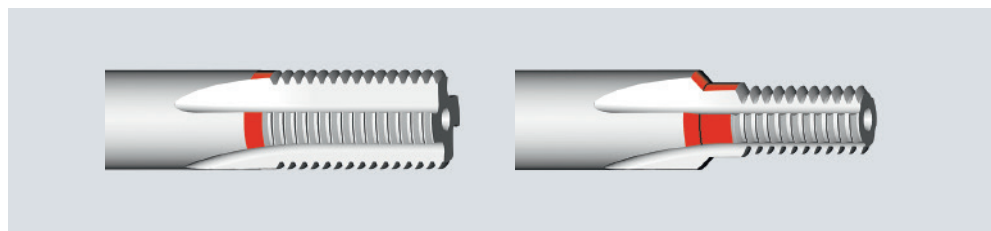

Geeignet für:

- Alle Typen GF, GSF und BGF

Suitable for:

- All types GF, GSF and BGF

Bemerkung:

- Am schaftseitigen Ende des Frästeils wird eine Stufe mit einer Länge von min. $1 \times P$ hinterschleifen
- Bei entsprechender Eintauchtiefe wird beim Gewindefräsen der unvollständige, gratbehaftete Gewindegang abgefräst (entfernt)

Note:

- At the rear end of the thread part, a step with a length of min. $1 \times P$ is relief-ground
- If the tool plunges to a correct depth during the thread milling process, the incomplete thread run-out with its burr is milled off (removed)

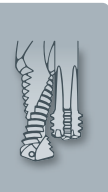

Halsfreischliff

Recessed neck

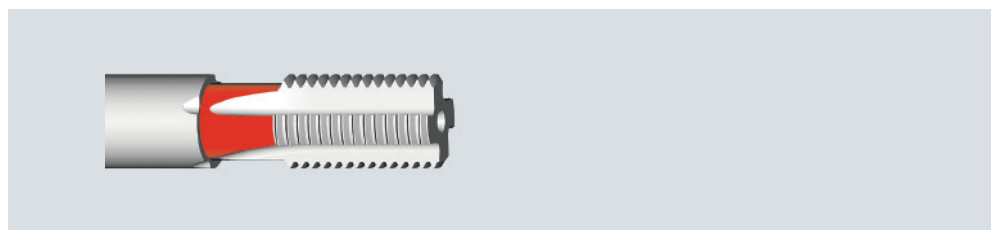

Geeignet für:

- Alle Typen GF und GSF (Senkfase entfällt)

Suitable for:

- All types GF and GSF (no countersinking step)

Bemerkung:

- Für größere Gewindetiefen (gesamte Gewindetiefe setzt sich aus zwei Fräsdurchläufen zusammen)
- Für einen konstanten Schnittdruck wird die Frästeillänge und die Halslänge im Verhältnis 1:1 aufgeteilt!
- Die Frästeillänge und der Versatz für einen zweiten Fräsdurchlauf sind immer ein ganzzahliges Vielfaches der Profilteilung

Note:

- For larger thread depths (total thread depth is achieved by a double milling process)
- For constant cutting pressure, the thread part length and the neck length are arranged in a ratio of 1:1!
- The thread part length and the offset for a second milling process are always a whole-number multiple of the thread pitch

3.3 Mögliche Modifikationen an Gewindfräsern

3.3 Possible modifications on thread milling cutters

AZR

Radial ausgesetzte Zahnreihen

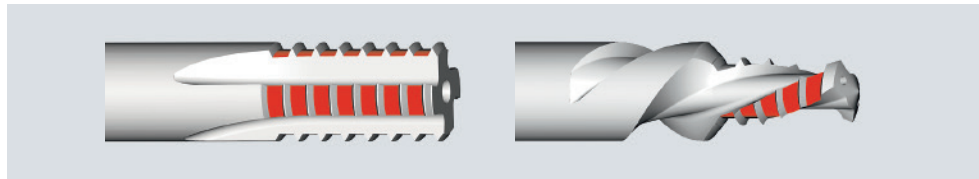

Geeignet für:

- Alle Typen GF, GSF und BGF

Bemerkung:

- Durch **AZR** werden die Seitenkräfte beim Gewindfräsen reduziert; die zyklisch fehlenden Gewindelücken werden durch zusätzliche zirkuläre Fräsumläufe gefräst

Eine nicht gezeigte Variante wäre auch **AZ** (abwechselnd ausgesetzte Zähne)

Vorteil:

- Zusätzliche zirkuläre Fräsumläufe entfallen; dadurch ergibt sich eine normale Einstichbreite am Bohrungsgrund bei BGF

Suitable for:

- All types GF, GSF and BGF

Note:

- AZR helps to reduce lateral forces in thread milling; the alternating missing gaps in the thread are produced by additional circular milling orbits

There is another variant, not shown here, called **AZ** (alternating teeth in a staggered sequence)

Advantage:

- No additional circular orbits are necessary; due to this, there is a perfectly normal recess depth at the hole bottom, if BGF type tools are used

IKZN

Innere Kühlschmierstoff-Zufuhr mit Austritt in den Nuten

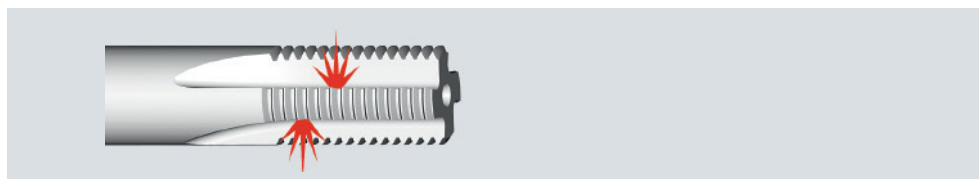

Internal coolant supply exiting in the flutes

Geeignet für:

- Alle Typen GF und GSF

Bemerkung:

- Stirnseitig verschlossene Axialbohrung für die Bearbeitung von Durchgangslöchern
- Für maximale Stabilität des Frästeils sind die seitlichen Austrittsbohrungen axial versetzt angeordnet

Suitable for:

- All types GF and GSF

Note:

- Axial coolant bore closed up at the tool face for the production of through hole threads
- For maximum stability of the cutting part, the lateral coolant holes are axially staggered

Schaftkühlritzen

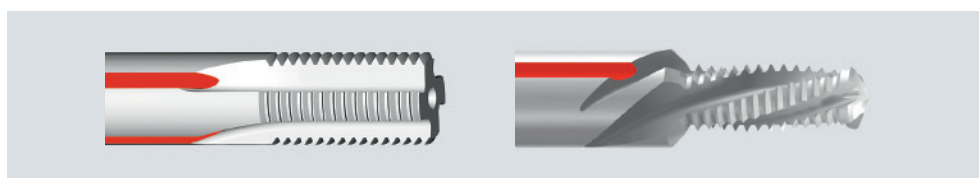

Coolant grooves along the shank

Geeignet für:

- Alle Typen GF, GSF und BGF

Bemerkung:

- Für die Bearbeitung von Durchgangslöchern
- Zusätzlich oder ersatzweise zu IKZ oder IKZN
- Ggf. unterstützend zur Kühlung der Senkfase bei GSF und BGF oder des Plansenkers bei MoSys-Anwendungen

Suitable for:

- All types GF, GSF and BGF

Note:

- For the production of through hole threads
- In addition or as an alternative to IKZ or IKZN
- Possible support in the cooling of the countersinking step of GSF and BGF type tools, or of the plane milling head in MoSys applications

Product
Finder v_c / f_z

M

MF

UNC
UN, UNSUNF
UNEF

G, Rp

NPT, NPTF
Rc, W

BSW, BSF

Pg

EG (STI)
SELF-LOCK

Tr

Zubehör
Accessories

Tech. Info

BGF

ZBGF

GSF

GF

GF-KEG

ZGF

ZIRK-GF

Gigant

MoSys



Product Finder

3.4 Berechnung der Schnittdaten

3.4 Calculation of cutting data

v_c / f_z

M

MF

UNC
UN, UNS

UNF
UNEF

G, Rp

NPT, NPTF
Rc, W

BSW, BSF

Pg

EG (STI)
SELF-LOCK

Tr

Zubehör
Accessories

Tech. Info

BGF

ZBGF

GSF

GF

GF-KEG

ZGF

ZIRK-GF

Gigant

MoSys

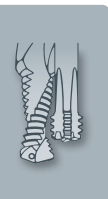

$$v_c = \frac{d_1 \cdot \pi \cdot n}{1000} \text{ [m/min]}$$

Schnittgeschwindigkeit v_c in m/min

d_1 = Frästeildurchmesser in mm
 n = Drehzahl in min^{-1}

Cutting speed v_c in m/min

d_1 = Milling part diameter in mm
 n = Speed in min^{-1} (rpm)

$$n = \frac{v_c \cdot 1000}{d_1 \cdot \pi} \text{ [min}^{-1}\text{]}$$

Drehzahl n in min^{-1}

d_1 = Frästeildurchmesser in mm
 v_c = Schnittgeschwindigkeit in m/min

Speed n in min^{-1} (rpm)

d_1 = Milling part diameter in mm
 v_c = Cutting speed in m/min

$$v_f = f_z \cdot Z \cdot n \text{ [mm/min]}$$

Vorschubgeschwindigkeit Kontur v_f in mm/min

f_z = Vorschub pro Zahn in mm
 Z = Anzahl der Nuten

Feed speed contour v_f in mm/min

f_z = Feed per tooth in mm
 Z = No. of flutes

$$v_{fM} = \frac{v_f \cdot (D - d_1)}{D} \text{ [mm/min]}$$

Vorschubgeschwindigkeit Mittelpunktsbahn (bei Innengewinde) v_{fM} in mm/min

v_f = Vorschubgeschwindigkeit in mm/min
 D = Gewinдененndurchmesser in mm
 d_1 = Frästeildurchmesser in mm

Feed speed centre orbit (with internal threads) v_{fM} in mm/min

v_f = Feed speed in mm/min
 D = Nominal thread diameter in mm
 d_1 = Milling part diameter in mm

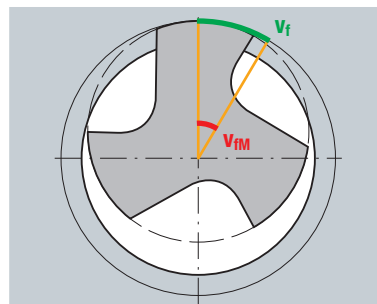

$$v_{fM} = \frac{v_f \cdot (D + d_1)}{D} \text{ [mm/min]}$$

Vorschubgeschwindigkeit Mittelpunktsbahn (bei Außengewinde) v_{fM} in mm/min

v_f = Vorschubgeschwindigkeit in mm/min
 D = Gewinдененndurchmesser in mm
 d_1 = Frästeildurchmesser in mm

Feed speed centre orbit (with external threads) v_{fM} in mm/min

v_f = Feed speed in mm/min
 D = Nominal thread diameter in mm
 d_1 = Milling part diameter in mm

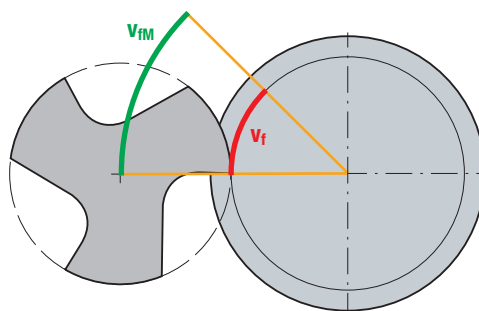







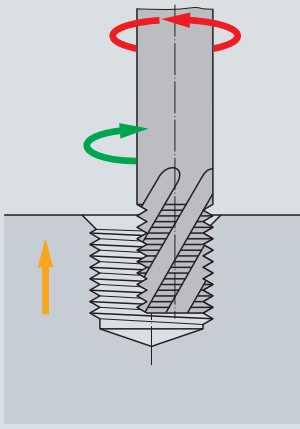
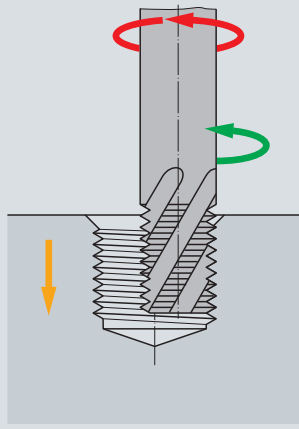
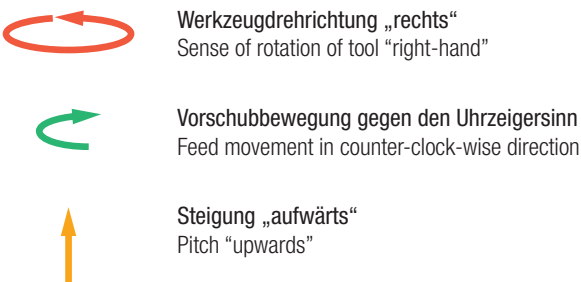

Der eingegebene Konturvorschub wird von der Maschine auf die Mittelpunktsbahn umgerechnet! Sollte dies nicht der Fall sein (erkennbar an einer wesentlich schnelleren Bearbeitungszeit bzw. Werkzeugbruch) muss der Mittelpunktsbahnvorschub eingegeben werden.

The contour feed entered is recalculated to the centre orbit by the machine! If this should not happen (to be recognised by the noticeably increased machining speed or by tool breakage), then the centre orbit feed must be entered manually.

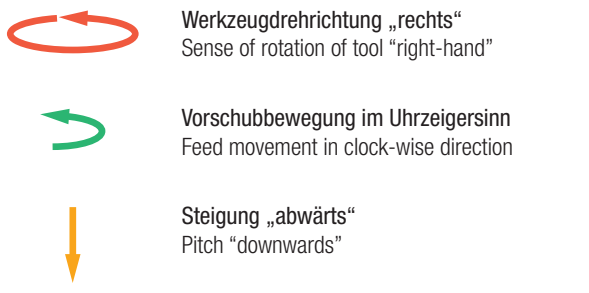
3.5 Gewindefräsverfahren (Rechtsgewinde)

3.5 Thread milling processes (right-hand thread)

<p>Gleichlaufräsen Climb milling</p>	<p>Gegenlaufräsen Conventional milling</p>
	
 <p>  Werkzeugdrehrichtung „rechts“ Sense of rotation of tool “right-hand” </p> <p>  Vorschubbewegung gegen den Uhrzeigersinn Feed movement in counter-clock-wise direction </p> <p>  Steigung „aufwärts“ Pitch “upwards” </p>	 <p>  Werkzeugdrehrichtung „rechts“ Sense of rotation of tool “right-hand” </p> <p>  Vorschubbewegung im Uhrzeigersinn Feed movement in clock-wise direction </p> <p>  Steigung „abwärts“ Pitch “downwards” </p>

Product Finder
v_c / f_z
M
MF
UNC UN, UNS
UNF UNEF
G, Rp
NPT, NPTF Rc, W
BSW, BSF
Pg
EG (STI) SELF-LOCK
Tr
Zubehör Accessories
Tech. Info
BGF
ZBGF
GSF
GF
GF-KEG
ZGF
ZIRK-GF
Gigant
MoSys

Product Finder

v_c / f_z

M

MF

UNC
UN, UNS

UNF
UNEF

G, Rp

NPT, NPTF
Rc, W

BSW, BSF

Pg

EG (STI)
SELF-LOCK

Tr

Zubehör
Accessories

Tech. Info

BGF

ZBGF

GSF

GF

GF-KEG

ZGF

ZIRK-GF



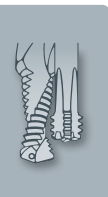

Gigant

MoSys



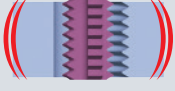

3.6 Probleme, mögliche Ursachen und Abhilfen beim Gewindefräsen

3.6 Problems, possible causes and solutions in thread milling

		Gewindefräsen allgemein Thread milling in general			
					
		Ratteln, Vibrationen Chattering, vibrations	Schlechte Werkstückoberfläche Bad surface quality on workpiece	übermäßiger Verschleiß Excessive wear	Schneidkanten- ausbrüche Chipped cutting edges
Mögliche Ursachen Possible causes		Abhilfen · Solutions			
~	Überprüfen Check				
↑	Steigern, erhöhen Increase				
↓	Vermindern Decrease				
GL	Gleichlaufräsen Climb milling				
GG	Gegenlaufräsen Conventional milling				
	Schnittgeschwindigkeit Cutting speed	~	~	↓	
	Vorschub pro Zahn Feed per tooth	~	~	↑	↓
	Stabilität (Werkstück/Werkstückspannung) Stability (workpiece/workpiece clamping)	↑	↑	↑	↑
	Stabilität (Werkzeug/Maschine) Stability (tool/machine)	↑	↑	↑	↑
	Auskraglänge Protruding length (of tool)	↓	↓	↓	~
	Werkzeugspirale (Drallnut) Tool helix (spiral flutes)	↑	↑	~	~
	Rundlaufgenauigkeit Concentricity	~	~	~	
	Beschichtung Coating			↑	↑
	Fräsverfahren/Programm/programmierter Radius Milling process/programme/programmed radius			GL	GL
	Einsatzbereich (Durchmesser-Verhältnis) Work case (relation of tool/thread diameters)				
	Werkzeugwechsel Tool change				
	NC-Achsen/Bahngeschwindigkeit (Rechner) NC axis/path speed (computer)	~	~	~	~
	Bohrvorschub (Entspannen) Drilling speed (remove chips)				
	Kühlschmierstoff-Druck/Austrittsbohrung Coolant-lubricant pressure (exit bore)			~	~

3.6 Probleme, mögliche Ursachen und Abhilfen beim Gewindefräsen

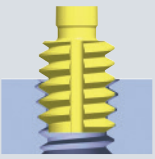
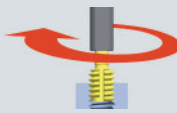
3.6 Problems, possible causes and solutions in thread milling

Gewindefräsen allgemein Thread milling in general		Bohrgewindefräsen Drill thread milling		
				
Gewinde wird konisch (Lehre klemmt auf Tiefe) Tapered thread shape (gauge jams after reaching a certain depth)	Geringe Toleranz von Gut- zu Ausschuss-Lehrung Small difference between go and no-go gauging	Markierung im Einfahrbereich Marks in the run-in area	Zahnausbrüche am Bohrgewindefräser Tooth chipping on the drill thread mill	Werkzeugbruch beim Bohren Tool breakage during the drilling process
Abhilfen · Solutions				
			~	
↓			~	
↑		~		
↑		~		
↓				
~				
	~		~	~
GG		~	~	
	~			
	~			
~		~	~	
			~	↓ ~
			~	~

- Product Finder
- v_c / f_z
- M
- MF
- UNC
UN, UNS
- UNF
UNEF
- G, Rp
- NPT, NPTF
Rc, W
- BSW, BSF
- Pg
- EG (STI)
SELF-LOCK
- Tr
- Zubehör
Accessories
- Tech. Info**
- BGF
- ZBGF
- GSF
- GF
- GF-KEG
- ZGF
- ZIRK-GF
- Gigant
- MoSys



- Product Finder
- v_c / f_z
- M
- MF
- UNC
UN, UNS
- UNF
UNEF
- G, Rp
- NPT, NPTF
Rc, W
- BSW, BSF
- Pg
- EG (STI)
SELF-LOCK
- Tr
- Zubehör
Accessories
- Tech. Info
- BGF
- ZBGF
- GSF
- GF
- GF-KEG
- ZGF
- ZIRK-GF
- Gigant
- MoSys

3.7 Programmierung Ein- und Ausfahren im Viertelkreis

3.7 Programming of run-in and run-out in a quarter circle

- Wird verwendet, wenn der Abstand zwischen Gewindefräser und Kernlochwand mindestens 1 x Steigung beträgt
- Programmierung nach DIN 66025
- Gleichlaufräsen
- Inkrementaler Aufbau an der Gewindekontur
- Unterprogramm zur Abarbeitung des Gewindes

- To be used if the distance between thread milling cutter and thread hole wall is 1 x pitch as a minimum
- Programming acc. DIN 66025
- Climb milling
- Incremental construction along the thread contour
- Sub-programme for processing the thread

Gewinde: M20 x 1,5 – Gewindetiefe 16 mm
Werkzeug: GF-VHM-R30-1KZ-HB (Z4)
Artikel-Nr.: GF162121.9514

Thread: M20 x 1,5 – Thread depth 16 mm
Tool: GF-VHM-R30-1KZ-HB (Z4)
Article no.: GF162121.9514

N 10	G 54	G 90	G 00	X...	Y...	Z 2	S 2500	T 01	M 03	Startpunkt · Start point ■ = Sicherheitsabstand 2 mm · Safety distance 2 mm
N 20	G 91	G 00				Z -18				Gewindetiefe abfahren · Run down to thread depth ■ = Sicherheitsabstand + Gewindetiefe · Safety distance + thread depth
N 30	G 01	Y 0,75		F 200						■ = 1/2 Steigung verfahren · Relocate by 1/2 pitch
N 40	G 41	G 01		X 9,25						■ = (Nenndurchm. – Steigung) / 2 · (Nominal dia. – pitch) / 2
N 50	G 03			X -9,25	Y 9,25	Z 0,375	I -9,25	J 0		■ = (Nenndurchm. – Steigung) / 2 · (Nominal dia. – pitch) / 2 ■ = Steigung / 4 · Pitch / 4
N 60	G 03			X 0	Y 0	Z 1,5	I 0	J -10		■ = Steigung · Pitch ■ = Nenndurchm. / 2 · Nominal dia. / 2
N 70	G 03			X -9,25	Y -9,25	Z 0,375	I 0	J -9,25		■ = (Nenndurchm. – Steigung) / 2 · (Nominal dia. – pitch) / 2 ■ = Steigung / 4 · Pitch / 4
N 80	G 00	G 40		X 9,25	Y -0,75					■ = (Nenndurchm. – Steigung) / 2 · (Nominal dia. – pitch) / 2 ■ = 1/2 Steigung verfahren · Relocate by 1/2 pitch
N 90	G 90					Z 2				■ = Endpunkt bzw. Ausgangspunkt · Finish point resp. point of origin

Programmablauf

Programme sequence

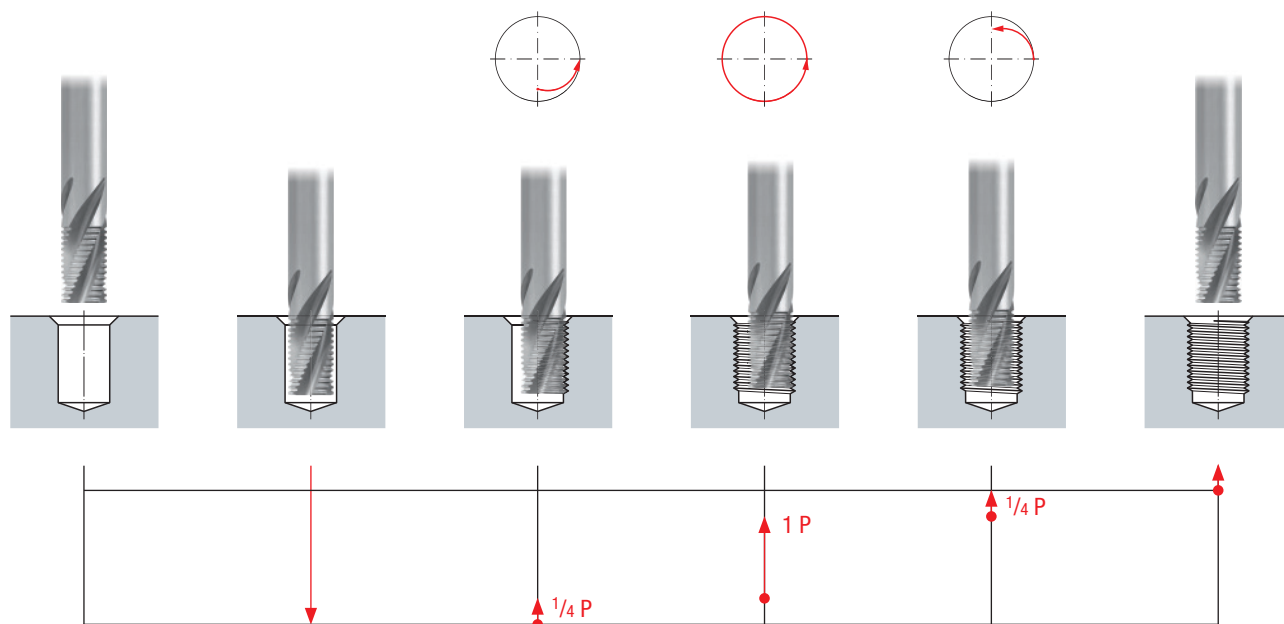

Programmierhilfen zum Gewindefräsen für DIN- und Heidenhain-Steuerungen sind auf www.emuge.de als Download verfügbar.

Programming support for thread milling with DIN and Heidenhain controls is available for download on www.emuge.de.

3.8 Programmierbeispiele (DIN)

Werkzeug: BGF-Z2 – 1,5 x D

3.8 Programming examples (DIN)

Tool: BGF-Z2 – 1.5 x D

Gewinde-Abmessung: Thread dimension:	M10 - 6H
Gewinde-Nenn Durchmesser D: Nominal thread diameter D:	10,000 mm
Gewindesteigung P: Thread pitch P:	1,500 mm
Kernlochdurchmesser D₁: Drilled hole diameter D ₁ :	8,500 mm
Bohr-/ Senktiefe l_E: Drilling/Countersinking depth l _E :	19,100 mm
Werkstoff: Material:	GAISI9
Werkzeug-Abmessungen: Tool dimensions:	∅ 8,2 x 19,1 x 79 mm
Schneidstoff: Cutting material:	VHM
Beschichtung: Coating:	TICN
Artikel-Nr.: Article no.:	GF422206.0100
Zähnezahl Z: No. of teeth Z:	2
Fräserdurchmesser d₁: Cutter diameter d ₁ :	8,200 mm
Fräserradiuskorrektur k¹⁾: Cutter radius compensation k ¹⁾ :	0,100 mm
zu programmierender Fräserradius²⁾: Cutter radius to be programmed ²⁾ :	4,000 mm
Schnittgeschwindigkeit v_c: Cutting speed v _c :	250 m/min
Vorschub pro Umdrehung (Bohren/Senken) f_b: Feed per revolution (Drilling/countersinking) f _b :	0,250 mm
Vorschub pro Zahn (Fräsen) f_z: Feed per tooth (milling) f _z :	0,100 mm
Drehzahl n: Speed n:	S = 9709 min ⁻¹
Vorschubgeschwindigkeit (Bohren/Senken) v_b: Feed speed (Drilling/countersinking) v _b :	F = 2427 mm/min
Vorschubgeschwindigkeit (Kontur) v_f: Feed speed (contour) v _f :	F = 1942 mm/min
Vorschubgeschwindigkeit (Mittelpunktsbahn) v_{fM}: Feed speed (centre point) v _{fM} :	F = 350 mm/min

(gemessen am Frästeil)
(measured on the cutting part)

$$(0,01 \cdot D)$$

$$(0,5 \cdot d_1 - k)$$

$$n = \frac{v_c \cdot 1000}{d_1 \cdot \pi}$$

$$v_b = f_b \cdot n$$

$$v_f = f_z \cdot Z \cdot n$$

$$v_{fM} = \frac{v_f \cdot (D - d_1)}{D}$$

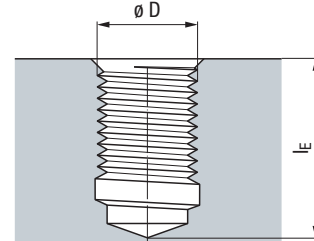
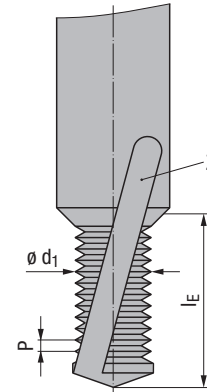

CNC-Innengewindefräsen (im Gleichlauf, an der Kontur, inkremental, nach DIN 66025)
CNC internal thread milling (climb milling, on the contour, incremental, acc. DIN 66025)

N 10	G 54	G 90	G 00	X...	Y...	Z 2	S 9709	T 01 ²⁾	M03
N 20	G 91	G 01	Z -21,100	F 2427 (Bohren/Senken · Drilling/countersinking)					
N 30	G 01	Z 0,500							
N 40	G 41	Y -4,250	F 1942 (Fräsen, Kontur · Milling, contour)				[F 350] ³⁾ (Mittelpunkt · Centre point)		
N 50	G 03	X 0	Y 9,250	Z 0,750	I 0	J 4,625			
N 60	G 03	X 0	Y 0	Z 1,500	I 0	J -5,000			
N 70	G 03	X 0	Y -9,250	Z 0,750	I 0	J -4,625			
N 80	G 00	G 40	X 0	Y 4,250					
N 90	G 90	Z 2							

Zerspanzeit t_n:
Machining time t_n: **2,3 sec.**

¹⁾ Der über die Zahnspitze des Gewindeteils gemessene Fräserradius ist um den Betrag der Fräserradiuskorrektur zu reduzieren. Hiermit wird eine Zustellung auf Mitte der „6H/ISO2-Muttertoleranz“ erreicht. Die Fräserradiuskorrektur hängt aber auch von der radialen Verdrängung des Werkzeuges ab (Festigkeit des zu fräsenden Materials und Auskraglänge).

²⁾ Der zu programmierende Fräserradius ist üblicherweise im Werkzeugspeicher enthalten.

³⁾ Bei Steuerungen, welche die Berechnung des Mittelpunktsvorschubs nicht selbstständig durchführen, müssen die Vorschubwerte in Klammern verwendet werden.

¹⁾ The cutter radius measured over the tooth crests of the threaded part must be reduced by the amount of the cutter radius compensation. This is necessary to achieve a depth of cut to the middle of the 6H/ISO2 nut tolerance. Please note, however, that this also depends on the radial deflection of the tool (tensile strength of the material, projection length of the tool).

²⁾ The cutter radius to be programmed is normally included in the tool memory.

³⁾ If your control does not calculate the centre point feed automatically please use the feed values printed in brackets.

Product Finder

v_c / f_z

M

MF

UNC
UN, UNS

UNF
UNEF

G, Rp

NPT, NPTF
Rc, W

BSW, BSF

Pg

EG (STI)
SELF-LOCK

Tr

Zubehör
Accessories

Tech. Info

BGF

ZBGF

GSF

GF

GF-KEG

ZGF

ZIRK-GF

Gigant

MoSys



Product Finder

v_c / f_z

3.8 Programmierbeispiele (DIN)

Werkzeug: ZBGF-W

3.8 Programming examples (DIN)

Tool: ZBGF-W

M	Gewinde-Abmessung: Thread dimension:	M12 x 1,5 - 6H
MF	Gewinde-Nenndurchmesser D: Nominal thread diameter D:	12,000 mm
UNC UN, UNS	Gewindesteigung P: Thread pitch P:	1,500 mm
UNF UNEF	Kernlochdurchmesser D₁: Drilled hole diameter D ₁ :	10,500 mm
G, Rp	Gewindetiefe b ³⁾: Thread depth b ³⁾ :	15,000 mm
NPT, NPTF Rc, W	Länge l₂: Length l ₂ :	6,000 mm
BSW, BSF	Werkstoff: Material:	GAISI9
Pg	Werkzeug-Abmessungen: Tool dimensions:	ø 7,75 x 6,9 x 76 mm
EG (STI) SELF-LOCK	Schneidstoff: Cutting material:	VHM
Tr	Beschichtung: Coating:	TIALN-T4
Zubehör Accessories	Artikel-Nr.: Article no.:	GF732257.0100
Tech. Info	Zähnezahl Z: No. of teeth Z:	4
BGF	Fräserdurchmesser d₁: Cutter diameter d ₁ :	7,750 mm
ZBGF	Fräserradiuskorrektur k ¹⁾: Cutter radius compensation k ¹⁾ :	0,120 mm
GSF	zu programmierender Fräserradius ¹⁾: Cutter radius to be programmed ¹⁾ :	3,755 mm
GF	Schnittgeschwindigkeit v_c: Cutting speed v _c :	250 m/min
GF-KEG	Vorschub pro Zahn (Fräsen) f_z: Feed per tooth (milling) f _z :	0,100 mm
ZGF	Drehzahl n: Speed n:	S = 10273 min ⁻¹
ZIRK-GF	Vorschubgeschwindigkeit (Kontur) v_f: Feed speed (contour) v _f :	F = 4109 mm/min
Gigant	Vorschubgeschwindigkeit (Mittelpunktsbahn) v_{fM}: Feed speed (centre point) v _{fM} :	F = 1455 mm/min
MoSys		

(gemessen am Frästeil)
(measured on the cutting part)

(je nach Einsatzfall)
(acc. work case)

(0,5 · d₁ - k)

$$n = \frac{v_c \cdot 1000}{d_1 \cdot \pi}$$

$$v_f = f_z \cdot Z \cdot n$$

$$v_{fM} = \frac{v_f \cdot (D - d_1)}{D}$$

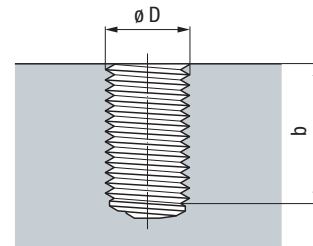
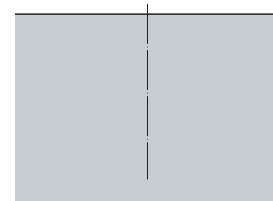
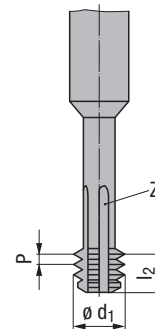

CNC-Innengewindefräsen (im Gegenlauf, an der Kontur, inkremental, nach DIN 66025)

CNC internal thread milling (conventional milling, on the contour, incremental, acc. DIN 66025)

N 10	G 54	G 90	G 00	X...	Y...	Z 1,500	S 10273	T 01 ²⁾	M 03
N 20	G 91								
N 30	G 42	G 01	X 0	Y -6	F 4109 (Kontur · contour)		[F 1455] ⁴⁾	(Mittelpunkt · Centre point)	
N 40	G 02	G 01	X 0	Y 0	Z -1,500	I 0	J 6,000		
... ⁵⁾									
N 50	G 40	G 01	X 0	Y 6					
N 70	G 90	G 00	Z 1,5						

Zerspanzeit t_h: Machining time t _h :	8,3 sec.
Anzahl der Gewindegänge ⁵⁾: Number of threads ⁵⁾ :	14

¹⁾ Der zu programmierende Fräserradius ist je nach Einsatzfall zu korrigieren, bis das Gewinde die gewünschte Muttertoleranz, z.B. 6H/ISO2 erreicht. Die Fräserradiuskorrektur hängt aber auch von der radialen Verdrängung des Werkzeugs ab (Festigkeit des zu fräsenden Materials und Auskraglänge).

²⁾ Der zu programmierende Fräserradius ist üblicherweise im Werkzeugspeicher enthalten.

³⁾ Die eingegebene Gewindetiefe b muss durch die Steigung P teilbar sein.

⁴⁾ Bei Steuerungen, welche die Berechnung des Mittelpunktvorschubs nicht selbstständig durchführen, müssen die Vorschubwerte in Klammern verwendet werden.

⁵⁾ Satz N 40 muss mit Anzahl der Gewindegänge wiederholt werden.

¹⁾ The cutter radius to be programmed must be corrected, depending on the work case, until the thread achieves the required nut tolerance, e.g. 6H/ISO2. Please note, however, that this also depends on the radial deflection of the tool (tensile strength of the material, projection length of the tool).

²⁾ The cutter radius to be programmed is normally included in the tool memory.

³⁾ The thread depth b as entered must be divisible by the pitch P.

⁴⁾ If your control does not calculate the centre point feed automatically please use the feed values printed in brackets.

⁵⁾ Block N 40 must be repeated with the number of threads.

3.8 Programmierbeispiele (DIN)

Werkzeug: GSF – 2 x D

3.8 Programming examples (DIN)

Tool: GSF – 2 x D

Gewinde-Abmessung: Thread dimension:	M10 - 6H
Gewinde-Nenndurchmesser D: Nominal thread diameter D:	10,000 mm
Gewindesteigung P: Thread pitch P:	1,500 mm
Kernlochdurchmesser D₁: Drilled hole diameter D ₁ :	8,500 mm
Senktiefe l_S: Countersinking depth l _S :	21,200 mm
Werkstoff: Material:	GAISI9

Werkzeug-Abmessungen: Tool dimensions:	∅ 8,2 x 21,2 x 80 mm
Schneidstoff: Cutting material:	VHM
Beschichtung: Coating:	TICN
Artikel-Nr.: Article no.:	GF332106.0100
Zähnezahl Z: No. of teeth Z:	3
Fräserdurchmesser d₁: Cutter diameter d ₁ :	8,200 mm

Fräserradiuskorrektur k¹: Cutter radius compensation k ¹ :	0,100 mm	(0,01 · D)
zu programmierender Fräserradius²: Cutter radius to be programmed ² :	4,000 mm	(0,5 · d ₁ - k)
Schnittgeschwindigkeit v_c: Cutting speed v _c :	250 m/min	
Vorschub pro Umdrehung (Senken) f_s: Feed per revolution (countersinking) f _s :	0,200 mm	
Vorschub pro Zahn (Fräsen) f_z: Feed per tooth (milling) f _z :	0,100 mm	
Drehzahl n: Speed n:	S = 9709 min ⁻¹	$n = \frac{v_c \cdot 1000}{d_1 \cdot \pi}$
Vorschubgeschwindigkeit (Senken) v_S: Feed speed (countersinking) v _S :	F = 1942 mm/min	v _S = f _s · n
Vorschubgeschwindigkeit (Kontur) v_f: Feed speed (contour) v _f :	F = 2913 mm/min	v _f = f _z · Z · n
Vorschubgeschwindigkeit (Mittelpunktsbahn) v_{FM}: Feed speed (centre point) v _{FM} :	F = 524 mm/min	$v_{FM} = \frac{v_f \cdot (D - d_1)}{D}$

(gemessen am Frästeil)
(measured on the cutting part)

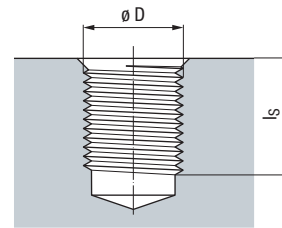
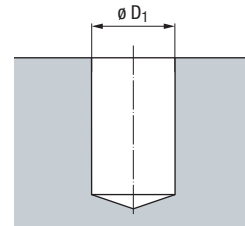
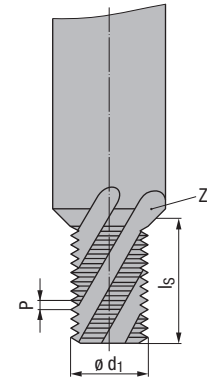

CNC-Innengewindefräsen (im Gleichlauf, an der Kontur, inkremental, nach DIN 66025)

CNC internal thread milling (climb milling, on the contour, incremental, acc. DIN 66025)

N 10	G 54	G 90	G 00	X...	Y...	Z 2	S 9709	T 01 ²⁾	M 03
N 20	G 91	Z -21,200							
N 30	G 01	Z -2			F 1942 (Senken · countersinking)				
N 40	G 01	Z 0,500							
N 50	G 41	Y -4,250			F 2913 (Fräsen, Kontur · Milling, contour)		[F 524] ³⁾	(Mittelpunkt · Centre point)	
N 60	G 03	X 0	Y 9,250	Z 0,750	I 0	J 4,625			
N 70	G 03	X 0	Y 0	Z 1,500	I 0	J -5,000			
N 80	G 03	X 0	Y -9,250	Z 0,750	I 0	J -4,625			
N 90	G 00	G 40	X 0	Y 4,250					
N 100	G 90	Z 2							

Zerspanzeit t_n: 1,3 sec.
Machining time t_n:

¹⁾ Der über die Zahnschneidkante des Gewindeteils gemessene Fräserradius ist um den Betrag der Fräserradiuskorrektur zu reduzieren. Hiermit wird eine Zustellung auf Mitte der „6H/ISO2-Muttertoleranz“ erreicht. Die Fräserradiuskorrektur hängt aber auch von der radialen Verdrängung des Werkzeuges ab (Festigkeit des zu fräsierenden Materials und Auskraglänge).
²⁾ Der zu programmierende Fräserradius ist üblicherweise im Werkzeugspeicher enthalten.
³⁾ Bei Steuerungen, welche die Berechnung des Mittelpunktsvorschubs nicht selbstständig durchführen, müssen die Vorschubwerte in Klammern verwendet werden.

¹⁾ The cutter radius measured over the tooth crests of the threaded part must be reduced by the amount of the cutter radius compensation. This is necessary to achieve a depth of cut to the middle of the 6H/ISO2 nut tolerance. Please note, however, that this also depends on the radial deflection of the tool (tensile strength of the material, projection length of the tool).
²⁾ The cutter radius to be programmed is normally included in the tool memory.
³⁾ If your control does not calculate the centre point feed automatically please use the feed values printed in brackets.

- Product Finder
- v_c / f_z
- M
- MF
- UNC UN, UNS
- UNF UNEF
- G, Rp
- NPT, NPTF Rc, W
- BSW, BSF
- Pg
- EG (STI) SELF-LOCK
- Tr
- Zubehör Accessories
- Tech. Info**
- BGF
- ZBGF
- GSF
- GF
- GF-KEG
- ZGF
- ZIRK-GF
- Gigant
- MoSys



Product Finder

v_c / f_z

M

MF

UNC
UN, UNS

UNF
UNEF

G, Rp

NPT, NPTF
Rc, W

BSW, BSF

Pg

EG (STI)
SELF-LOCK

Tr

Zubehör
Accessories

Tech. Info

BGF

ZBGF

GSF

GF

GF-KEG

ZGF

ZIRK-GF

Gigant

MoSys

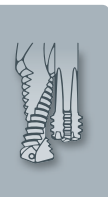

3.8 Programmierbeispiele (DIN)

Werkzeug: GF

Gewinde-Abmessung: Thread dimension:	M30 x 1,5 - 6H
Gewinde-Nenndurchmesser D: Nominal thread diameter D:	30,000 mm
Gewindesteigung P: Thread pitch P:	1,500 mm
Kernlochdurchmesser D₁: Drilled hole diameter D ₁ :	28,500 mm
Gewindetiefe b: Thread depth b:	25,000 mm
Werkstoff: Material:	GAISI9
Werkzeug-Abmessungen: Tool dimensions:	∅ 20 x 32 x 105 mm
Schneidstoff: Cutting material:	VHM
Beschichtung: Coating:	TICN
Artikel-Nr.: Article no.:	GF163156.9514
Zähnezahl Z: No. of teeth Z:	5
Fräserdurchmesser d₁: Cutter diameter d ₁ :	20,000 mm
Fräserradiuskorrektur k¹: Cutter radius compensation k ¹ :	0,075 mm
zu programmierender Fräserradius²: Cutter radius to be programmed ² :	9,925 mm
Schnittgeschwindigkeit v_c: Cutting speed v _c :	250 m/min
Vorschub pro Zahn (Fräsen) f_z: Feed per tooth (milling) f _z :	0,100 mm
Drehzahl n: Speed n:	S = 3981 min ⁻¹
Vorschubgeschwindigkeit (Kontur) v_f: Feed speed (contour) v _f :	F = 1990 mm/min
Vorschubgeschwindigkeit (Mittelpunktsbahn) v_{fM}: Feed speed (centre point) v _{fM} :	F = 663 mm/min

(gemessen am Frästeil)
(measured on the cutting part)

$$(0,05 \cdot P)$$

$$(0,5 \cdot d_1 - k)$$

$$n = \frac{v_c \cdot 1000}{d_1 \cdot \pi}$$

$$v_f = f_z \cdot Z \cdot n$$

$$v_{fM} = \frac{v_f \cdot (D - d_1)}{D}$$

3.8 Programming examples (DIN)

Tool: GF

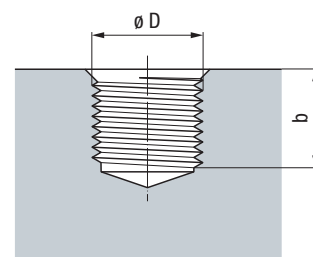
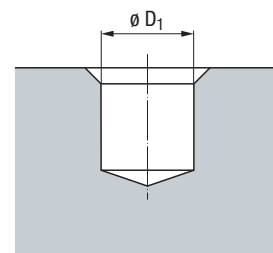
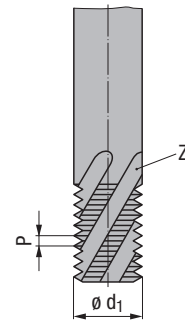

CNC-Innengewindefräsen (im Gleichlauf, an der Kontur, inkremental, nach DIN 66025)

CNC internal thread milling (climb milling, on the contour, incremental, acc. DIN 66025)

N 10	G 54	G 90	G 00	X...	Y...	Z 2	S 3981	T 01 ²⁾	M 03
N 20	G 91	G 00	Z -27						
N 30	G 01	Y 0,750			F 1990 (Kontur · Contour)		[F 663] ³⁾	(Mittelpunkt · Centre point)	
N 40	G 41	G 01	X 14,25						
N 50	G 03	X -14,250	Y 14,25	Z 0,375	I -14,250	J 0			
N 60	G 03	X 0	Y 0	Z 1,5	I 0	J -15,000			
N 70	G 03	X -14,250	Y -14,25	Z 0,375	I 0	J -14,250			
N 80	G 00	G 40	X 14,25	Y -0,75					
N 90	G 90	Z 2							

Zerspanzeit t_h:
Machining time t_h: **4,2 sec.**

¹⁾ Der über die Zahnschneidkante des Gewindeteils gemessene Fräserradius ist um den Betrag der Fräserradiuskorrektur zu reduzieren. Hiermit wird eine Zustellung auf Mitte der „6H/ISO2-Muttertoleranz“ erreicht. Die Fräserradiuskorrektur hängt aber auch von der radialen Verdrängung des Werkzeuges ab (Festigkeit des zu fräsenden Materials und Auskräglänge).

²⁾ Der zu programmierende Fräserradius ist üblicherweise im Werkzeugspeicher enthalten.

³⁾ Bei Steuerungen, welche die Berechnung des Mittelpunktvorschubs nicht selbstständig durchführen, müssen die Vorschubwerte in Klammern verwendet werden.

¹⁾ The cutter radius measured over the tooth crests of the threaded part must be reduced by the amount of the cutter radius compensation. This is necessary to achieve a depth of cut to the middle of the 6H/ISO2 nut tolerance. Please note, however, that this also depends on the radial deflection of the tool (tensile strength of the material, projection length of the tool).

²⁾ The cutter radius to be programmed is normally included in the tool memory.

³⁾ If your control does not calculate the centre point feed automatically please use the feed values printed in brackets.

3.8 Programmierbeispiele (DIN)

Werkzeug: GF-KEG

Gewinde-Abmessung: Thread dimension:	NPT 1/2 - 14
Gewinde-Außendurchmesser D: Thread major diameter D:	21,092 mm
Kegelverhältnis: Taper ratio:	1 : 16
Steigung: Pitch:	1,814 mm
Kernlochdurchmesser D₃: Drilled hole diameter D ₃ :	17,850 mm
Nutzbare Tiefe t₄: Usable depth t ₄ :	15,384 mm
Werkstoff: Material:	GAISI9
Werkzeug-Abmessungen: Tool dimensions:	ø 14,25 x 19,01 x 80 mm
Schneidstoff: Cutting material:	VHM
Beschichtung: Coating:	TICN
Artikel-Nr.: Article no.:	GF173136.9678
Zähnezahl Z: No. of teeth Z:	4
Fräserdurchmesser d₁: Cutter diameter d ₁ :	14,250 mm
zu programmierender Fräserradius: Cutter radius to be programmed:	7,080 mm
Schnittgeschwindigkeit v_c: Cutting speed v _c :	250 m/min
Vorschub pro Zahn (Fräsen) f_z: Feed per tooth (milling) f _z :	0,120 mm
Drehzahl n: Speed n:	S = 5584 min ⁻¹
Vorschubgeschwindigkeit (Kontur) v_f: Feed speed (contour) v _f :	F = 2681 mm/min
Vorschubgeschwindigkeit (Mittelpunktsbahn) v_{fM}: Feed speed (centre point) v _{fM} :	F = 870 mm/min

(gemessen am Frästeil)
(measured on the cutting part)

$$n = \frac{v_c \cdot 1000}{d_1 \cdot \pi}$$

$$v_f = f_z \cdot Z \cdot n$$

$$v_{fM} = \frac{v_f \cdot (D - d_1)}{D}$$

3.8 Programming examples (DIN)

Tool: GF-KEG

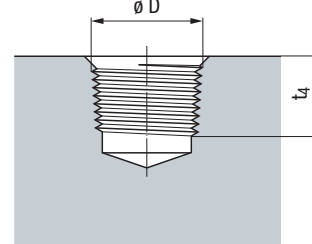
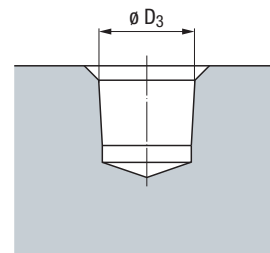
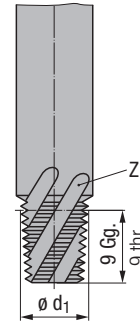

CNC-Innengewindefräsen (im Gleichlauf, an der Kontur, inkremental, nach DIN 66025)

CNC internal thread milling (climb milling, on the contour, incremental, acc. DIN 66025)

N 10	G 54	G 90	G 00	X...	Y...	Z 2	S 5584	T 01	M 03
N 20	G 91	G 00	Z -17,384						
N 30	G 01	G 41	Y -8,925	F 2681 (Kontur · Contour)			[F 870] ¹⁾ (Mittelpunkt · Centre point)		
N 40	G 03	X 0,000	Y 19,471	Z 0,907	I 0,000	J 9,736			
N 50	G 03	X -10,560	Y -10,546	Z 0,454	I -0,007	J -10,553			
N 60	G 03	X 10,560	Y -10,574	Z 0,454	I 10,567	J -0,007			
N 70	G 03	X 10,589	Y 10,574	Z 0,454	I 0,007	J 10,581			
N 80	G 03	X -10,589	Y 10,603	Z 0,454	I -10,596	J 0,007			
N 90	G 03	X 0,000	Y -19,528	Z 0,907	I 0,000	J -9,764			
N 100	G 01	G 40	Y 8,925						
N 110	G 90								
N 120	Z 2								

Zerspanzeit t_n: 2,9 sec.
Machining time t_n:

Das erste gefräste Gewinde ist unbedingt zu lehren, um eine eventuell erforderliche Werkzeugradius- oder Tiefenkorrektur vorzunehmen, welche sich aus dem planseitigen Abstand der Lehdorn-Messstufen zum Werkstück ergibt.

- Variable Werte zur Beeinflussung des gefrästen Gewindedurchmessers sind:**
1. Der zu programmierende Fräserradius im Werkzeugspeicher
 2. Die Eintauchtiefe (Gewindetiefe) Z- im Satz N 20

Radiuskorrektur = fehlende Einschraubtiefe x Kegelverhältnis (1 : 16) : 2

Merke: Ein kleinerer Werkzeugradius bewirkt ein tieferes Einschrauben!

¹⁾ Bei Steuerungen, welche die Berechnung des Mittelpunktvorschubs nicht selbstständig durchführen, müssen die Vorschubwerte in Klammern verwendet werden.

Please note that it is essential to gauge the first finished thread! This will make it possible to introduce a tool radius or depth compensation which may be necessary. Compensation is made by adjusting the distance of the measuring steps on the plane side of the plug gauge from the workpiece.

Variables for influencing the thread diameter on the workpiece:

1. The cutter radius to be programmed in the tool memory
2. The plunge depth (thread depth Z- in block N 20)

Radius compensation = lacking screw-in depth x taper ratio (1 : 16) : 2

Please note: A smaller tool radius will create an increased screw-in depth!

¹⁾ If your control does not calculate the centre point feed automatically please use the feed values printed in brackets.

Product Finder

v_c / f_z

M

MF

UNC
UN, UNS

UNF
UNEF

G, Rp

NPT, NPTF
Rc, W

BSW, BSF

Pg

EG (STI)
SELF-LOCK

Tr

Zubehör
Accessories

Tech. Info

BGF

ZBGF

GSF

GF

GF-KEG

ZGF

ZIRK-GF

Gigant

MoSys



Product Finder

v_c / f_z

M

MF

UNC
UN, UNS

UNF
UNEF

G, Rp

NPT, NPTF
Rc, W

BSW, BSF

Pg

EG (STI)
SELF-LOCK

Tr

Zubehör
Accessories

Tech. Info

BGF

ZBGF

GSF

GF

GF-KEG

ZGF

ZIRK-GF

Gigant

MoSys

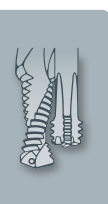

3.8 Programmierbeispiele (DIN)

Werkzeug: GF (Außengewinde)

Gewinde-Abmessung: Thread dimension:	M20 x 1,5 - 6g
Gewinde-Nenndurchmesser D: Nominal thread diameter D:	20,000 mm
Gewindesteigung P: Thread pitch P:	1,500 mm
Gewindelänge b: Thread length b:	20,000 mm
Werkstoff: Material:	GAISI9
Werkzeug-Abmessungen: Tool dimensions:	∅ 20 x 32 x 105 mm
Schneidstoff: Cutting material:	VHM
Beschichtung: Coating:	TICN
Artikel-Nr.: Article no.:	GF161156.9514
Zähnezahl Z: No. of teeth Z:	5
Fräserdurchmesser d₁: Cutter diameter d ₁ :	20,000 mm
Fräserradiuskorrektur k¹⁾: Cutter radius compensation k ¹⁾ :	0,075 mm
zu programmierender Fräserradius²⁾: Cutter radius to be programmed ²⁾ :	9,925 mm
Schnittgeschwindigkeit v_c: Cutting speed v _c :	250 m/min
Vorschub pro Zahn (Fräsen) f_z: Feed per tooth (milling) f _z :	0,150 mm
Drehzahl n: Speed n:	S = 3981 min ⁻¹
Vorschubgeschwindigkeit (Kontur) v_f: Feed speed (contour) v _f :	F = 2986 mm/min
Vorschubgeschwindigkeit (Mittelpunktsbahn) v_{fM}: Feed speed (centre point) v _{fM} :	F = 5971 mm/min

3.8 Programming examples (DIN)

Tool: GF (external thread)

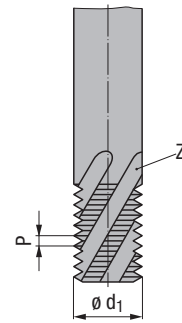

(gemessen am Frästeil)
(measured on the cutting part)

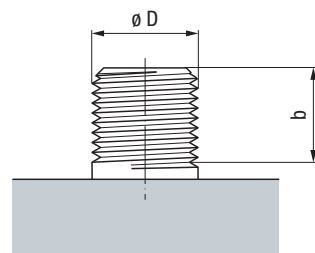
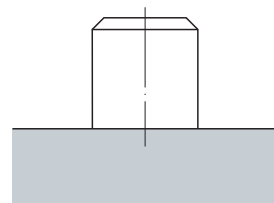

$$n = \frac{v_c \cdot 1000}{d_1 \cdot \pi}$$

$$v_f = f_z \cdot Z \cdot n$$

$$v_{fM} = \frac{v_f \cdot (D + d_1)}{D}$$

CNC-Außengewindefräsen (im Gleichlauf, an der Kontur, inkremental, nach DIN 66025)

CNC external thread milling (climb milling, on the contour, incremental, acc. DIN 66025)

N 10	G 54	G 90	G 00	X ...	Y ...	Z 2	S 3981	T 01 ²⁾	M,03
N 20	G 91	G 00	X -10,000	Y 20,000					
N 30	G 00	Z -19,750							
N 40	G 41	G 01	Y -10,975		F 2986 (Kontur · Contour)		[F 5971] ³⁾	(Mittelpunkt · Centre point)	
N 50			X 10,000	Z -0,300					
N 60	G 02	X 0	Y 0	Z -1,500	I 0	J -9,025			
N 70	G 01	X 10,000	Y 0	Z -0,300					
N 80	G 40	G 00	Y 10,975						
N 90	G 90	Z 2							

Zerspanzeit t_h:
Machining time t_h: **1,5 sec.**

¹⁾ Der über die Zahnspitze des Gewindeteils gemessene Fräserradius ist um den Betrag der Fräserradiuskorrektur zu reduzieren. Hiermit wird eine Zustellung auf Mitte der „6g/ISO2-Bolzentoleranz“ erreicht. Die Fräserradiuskorrektur hängt aber auch von der radialen Verdrängung des Werkzeuges ab (Festigkeit des zu fräsenden Materials und Auskrümmung).

²⁾ Der zu programmierende Fräserradius ist üblicherweise im Werkzeugspeicher enthalten.

³⁾ Bei Steuerungen, welche die Berechnung des Mittelpunktsvorschubs nicht selbstständig durchführen, müssen die Vorschubwerte in Klammern verwendet werden.

¹⁾ The cutter radius measured over the tooth crests of the threaded part must be reduced by the amount of the cutter radius compensation. This is necessary to achieve a depth of cut to the middle of the 6g/ISO2 bolt tolerance. Please note, however, that this also depends on the radial deflection of the tool (tensile strength of the material, projection length of the tool).

²⁾ The cutter radius to be programmed is normally included in the tool memory.

³⁾ If your control does not calculate the centre point feed automatically please use the feed values printed in brackets.

3.8 Programmierbeispiele (DIN)

Werkzeug: ZIRK-GF

3.8 Programming examples (DIN)

Tool: ZIRK-GF

Gewinde-Abmessung: Thread dimension:	M30 x 1,5 - 6H
Gewinde-Nenndurchmesser D: Nominal thread diameter D:	30,000 mm
Gewindesteigung P: Thread pitch P:	1,500 mm
Kernlochdurchmesser D₁: Drilled hole diameter D ₁ :	28,500 mm
Gewindetiefe b: Thread depth b:	25,000 mm
Werkstoff: Material:	GAISI9
Werkzeug-Abmessungen: Tool dimensions:	∅ 16 x 125 mm
Schneidstoff: Cutting material:	HM
Beschichtung: Coating:	TIN
Artikel-Nr.: Article no.:	GZ301310 GF603115.9514
Zähnezahl Z: No. of teeth Z:	1
Fräserdurchmesser d₁: Cutter diameter d ₁ :	16,000 mm
Schneidenlänge l₂: Cutting length l ₂ :	15,000 mm
Fräserradiuskorrektur k¹⁾: Cutter radius compensation k ¹⁾ :	0,075 mm
zu programmierender Fräserradius²⁾: Cutter radius to be programmed ²⁾ :	7,925 mm
Schnittgeschwindigkeit v_c: Cutting speed v _c :	250 m/min
Vorschub pro Zahn (Fräsen) f_z: Feed per tooth (milling) f _z :	0,150 mm
Drehzahl n: Speed n:	S = 4976 min ⁻¹
Vorschubgeschwindigkeit (Kontur) v_f: Feed speed (contour) v _f :	F = 746 mm/min
Vorschubgeschwindigkeit (Mittelpunktsbahn) v_{fM}: Feed speed (centre point) v _{fM} :	F = 348 mm/min

(gemessen am Frästeil)
(measured on the cutting part)

$$(0,05 \cdot P)$$

$$(0,5 \cdot d_1 - k)$$

$$n = \frac{v_c \cdot 1000}{d_1 \cdot \pi}$$

$$v_f = f_z \cdot Z \cdot n$$

$$v_{fM} = \frac{v_f \cdot (D - d_1)}{D}$$

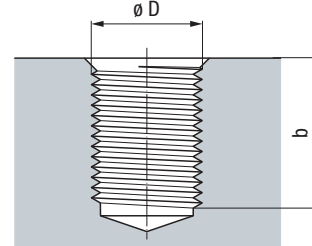
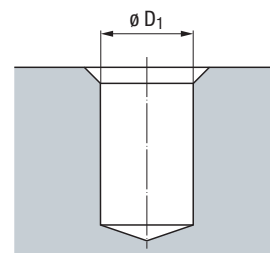
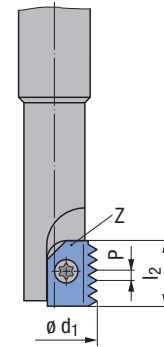

CNC-Innengewindefräsen (im Gleichlauf, an der Kontur, inkremental, nach DIN 66025)

CNC internal thread milling (climb milling, on the contour, incremental, acc. DIN 66025)

N 10	G 54	G 90	G 00	X ...	Y ...	Z 2	S 4976	T01 ²⁾	M03
N 20	G 91	G 00	Z-27,000						
N 30	G 01	Y 0,750				F 746 (Kontur · Contour)		[F 348] ³⁾ (Mittelpunkt · Centre point)	
N 40	G 41	G 01	X 14,250						
N 50	G 03	X -14,250	Y 14,250	Z 0,375	I -14,250	J 0			
N 60	G 03	X 0	Y 0	Z 1,500	I 0	J -15,000			
N 70	G 03	X -14,250	Y-14,250	Z 0,375	I 0	J -14,250			
N 80	G 00	G 40	X 14,250	Y -0,750					
N 90	G 00	Z 11,250							
... ⁴⁾									
N 170	G90								

Zerspanzeit t_h: 22,3 sec.
Machining time t_h:

¹⁾ Der über die Zahnspitze des Gewindeteils gemessene Fräserradius ist um den Betrag der Fräserradiuskorrektur zu reduzieren. Hiermit wird eine Zustellung auf Mitte der „6H/ISO2-Muttertoleranz“ erreicht. Die Fräserradiuskorrektur hängt aber auch von der radialen Verdrängung des Werkzeuges ab (Festigkeit des zu fräsenden Materials und Auskraglänge).

²⁾ Der zu programmierende Fräserradius ist üblicherweise im Werkzeugspeicher enthalten.

³⁾ Bei Steuerungen, welche die Berechnung des Mittelpunktsvorschubs nicht selbstständig durchführen, müssen die Vorschubwerte in Klammern verwendet werden.

⁴⁾ Die Satznummern N 30 bis N 90 müssen entsprechend der Anzahl der Wiederholungen erneut aufgerufen werden.

¹⁾ The cutter radius measured over the tooth crests of the threaded part must be reduced by the amount of the cutter radius compensation. This is necessary to achieve a depth of cut to the middle of the 6H/ISO2 nut tolerance. Please note, however, that this also depends on the radial deflection of the tool (tensile strength of the material, projection length of the tool).

²⁾ The cutter radius to be programmed is normally included in the tool memory.

³⁾ If your control does not calculate the centre point feed automatically please use the feed values printed in brackets.

⁴⁾ The block numbers N 30 to N 90 must be called up anew according to the number of repetitions.

Product Finder

v_c / f_z

M

MF

UNC
UN, UNS

UNF
UNEF

G, Rp

NPT, NPTF
Rc, W

BSW, BSF

Pg

EG (STI)
SELF-LOCK

Tr

Zubehör
Accessories

Tech. Info

BGF

ZBGF

GSF

GF

GF-KEG

ZGF

ZIRK-GF

Gigant

MoSys



Product Finder
v_c / f_z

3.8 Programmierbeispiele (DIN)

Werkzeug: Gigant-ic, Gr.12

3.8 Programming examples (DIN)

Tool: Gigant-ic, Size 12

M	Gewinde-Abmessung: Thread dimension:	M42 - 6H
MF	Gewinde-Nenndurchmesser D: Nominal thread diameter D:	42,000 mm
UNC UN, UNS	Gewindesteigung P: Thread pitch P:	4,500 mm
UNF UNEF	Kernlochdurchmesser D₁: Drilled hole diameter D ₁ :	37,500 mm
G, Rp	Gewindetiefe b³⁾: Thread depth b ³⁾ :	63,000 mm
NPT, NPTF Rc, W	Werkstoff: Material:	1.1730
BSW, BSF	Werkzeug-Abmessungen: Tool dimensions:	∅ 32,85 x 153 mm
Pg	Schneidstoff: Cutting material:	VHM
EG (STI) SELF-LOCK	Beschichtung: Coating:	TIN
Tr	Artikel-Nr.: Article no.:	GZ341032 GF643205.9517
Zubehör Accessories	Zähnezahl Z: No. of teeth Z:	3
Tech. Info	Fräserdurchmesser d₁: Cutter diameter d ₁ :	32,850 mm
BGF	Fräserradiuskorrektur k¹⁾: Cutter radius compensation k ¹⁾ :	0,174 mm
ZBGF	zu programmierender Fräserradius²⁾: Cutter radius to be programmed ²⁾ :	16,251 mm
GSF	Schnittgeschwindigkeit v_c: Cutting speed v _c :	250 m/min
GF	Vorschub pro Zahn (Fräsen) f_z: Feed per tooth (milling) f _z :	0,200 mm
GF-KEG	Drehzahl n: Speed n:	S = 2424 min ⁻¹
ZGF	Vorschubgeschwindigkeit (Kontur) v_f: Feed speed (contour) v _f :	F = 1454 mm/min
Gigant	Vorschubgeschwindigkeit (Mittelpunktsbahn) v_{fM}: Feed speed (centre point) v _{fM} :	F = 317 mm/min
MoSys		

(gemessen am Frästeil)
(measured on the cutting part)

(je nach Einsatzfall)
(acc. work case)

(0,5 · d₁ - k)

$$n = \frac{v_c \cdot 1000}{d_1 \cdot \pi}$$

$$v_f = f_z \cdot Z \cdot n$$

$$v_{fM} = \frac{v_f \cdot (D - d_1)}{D}$$

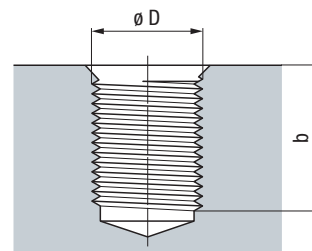
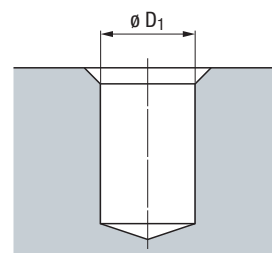
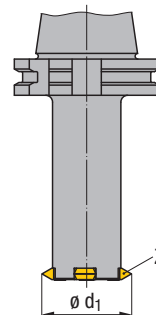

CNC-Innengewindefräsen (im Gegenlauf, an der Kontur, inkremental, nach DIN 66025)

CNC internal thread milling (conventional milling, on the contour, incremental, acc. DIN 66025)

N 10	G 54	G 90	G 00	X...	Y...	Z 0,000	S 2424	T01 ²⁾	M03
N 20	G 91								
N 30	G 42	G 01		X 0	Y -21	F 1454 (Kontur - Contour)		[F 317] ⁴⁾	(Mittelpunkt - Centre point)
N 40	G 02			X 0	Y 0	Z -4,500	I 0	J 21,000	
... ⁵⁾									
N 50	G 40	G 01		X 0	Y 21				
N 70	G 90	G 00		Z 4,5					

Zerspanzeit t_h: Machining time t _h :	72,6 sec. (1,2 min.)
Anzahl der Gewindegänge⁵⁾: Number of threads ⁵⁾ :	13

¹⁾ Der zu programmierende Fräserradius ist je nach Einsatzfall zu korrigieren, bis das Gewinde die gewünschte Muttertoleranz, z.B. 6H/ISO2 erreicht. Die Fräserradiuskorrektur hängt aber auch von der radialen Verdrängung des Werkzeugs ab (Festigkeit des zu fräsenden Materials und Auskraglänge).
²⁾ Der zu programmierende Fräserradius ist üblicherweise im Werkzeugspeicher enthalten.
³⁾ Die eingegebene Gewindetiefe b muss durch die Steigung P teilbar sein.
⁴⁾ Bei Steuerungen, welche die Berechnung des Mittelpunktsvorschubs nicht selbstständig durchführen, müssen die Vorschubwerte in Klammern verwendet werden.
⁵⁾ Satz N 40 muss mit Anzahl der Gewindegänge wiederholt werden.

¹⁾ The cutter radius to be programmed must be corrected, depending on the work case, until the thread achieves the required nut tolerance, e.g. 6H/ISO2. Please note, however, that this also depends on the radial deflection of the tool (tensile strength of the material, projection length of the tool).
²⁾ The cutter radius to be programmed is normally included in the tool memory.
³⁾ The thread depth b as entered must be divisible by the pitch P.
⁴⁾ If your control does not calculate the centre point feed automatically please use the feed values printed in brackets.
⁵⁾ Block N 40 must be repeated with the number of threads.

3.9 Technischer Fragebogen: Gewindefräsen

Firma:
 Ansprechpartner:
 Telefon:
 Fax:
 E-Mail:

Abmessung:
 Ausführung:
 Artikel-Nr.:
 Projekt:

Werkstückbezeichnung:
 Werkstückwerkstoff:

Ident-Nr.:
 Festigkeit / Härte:

Einsatzbedingungen:

Maschinentyp:
 Steuerung:
 horizontal vertikal
 Werkzeugaufnahme:
 Schnittgeschwindigkeit v_c : m/min
 Drehzahl n: min^{-1}
 Standwert: (Anzahl der Gewinde)

Spindelaufnahme:
 Kernlochform / Bolzenform:
 Kühlschmierstoff:
 Druck: IKZ
 Vorschubwerte: f_z : mm
 f_s : mm
 f_b : mm

Kunde fräst bereits Gewinde:
 Abmessung:
 Hersteller:

Ergebnis / besondere Hinweise:

Zu erledigen:

Skizze:

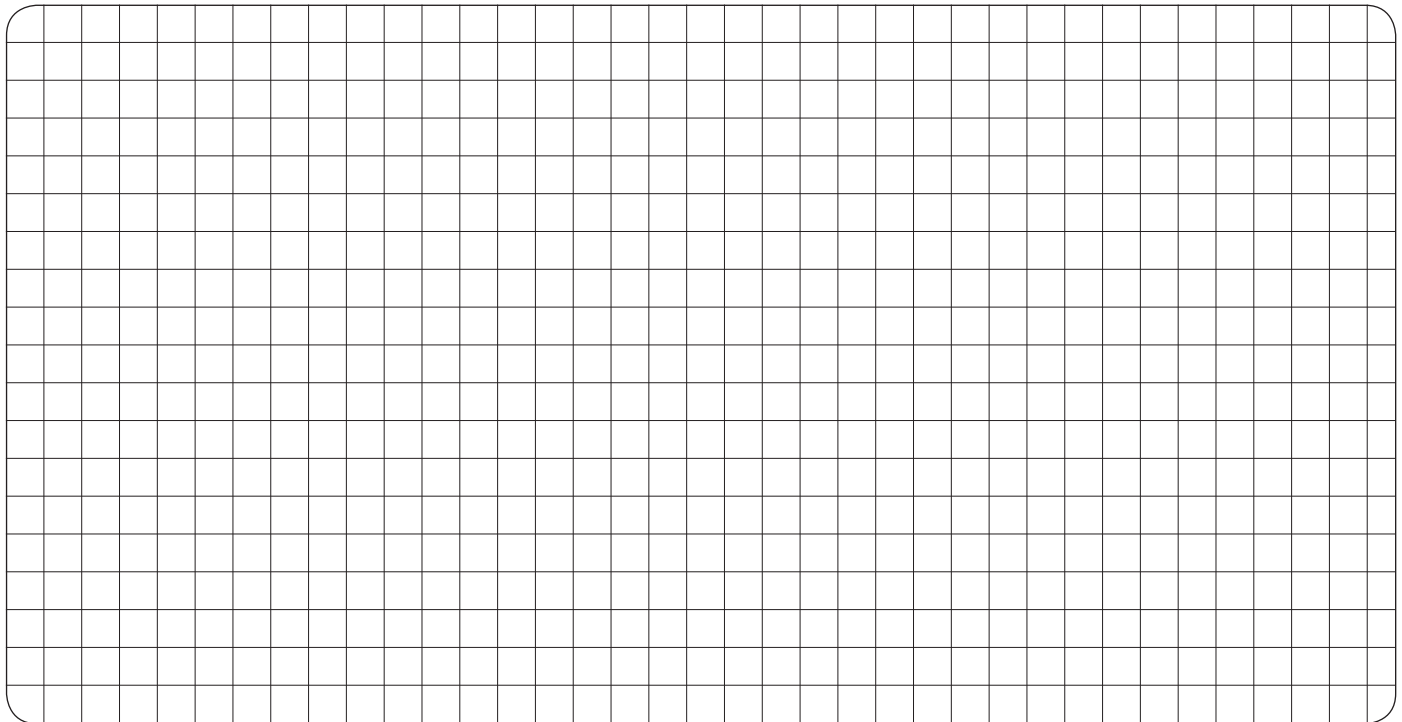

Aufgenommen von:

Datum / Unterschrift:

Product Finder

v_c / f_z

M

MF

UNC
UN, UNS

UNF
UNEF

G, Rp

NPT, NPTF
Rc, W

BSW, BSF

Pg

EG (STI)
SELF-LOCK

Tr

Zubehör
Accessories

Tech. Info

BGF

ZBGF

GSF

GF

GF-KEG

ZGF

ZIRK-GF

Gigant

MoSys



- Product Finder
- v_c / f_z
- M
- MF
- UNC
UN, UNS
- UNF
UNEF
- G, Rp
- NPT, NPTF
Rc, W
- BSW, BSF
- Pg
- EG (STI)
SELF-LOCK
- Tr
- Zubehör
Accessories
- Tech. Info**
- BGF
- ZBGF
- GSF
- GF
- GF-KEG
- ZGF
- ZIRK-GF
- Gigant
- MoSys

3.9 Technical questionnaire: Thread milling

Company: Size:
 Contact: Design:
 Phone: Article no.:
 Fax: Project:
 E-mail:

Workpiece description: Ident no.:
 Workpiece material: Tensile strength / hardness:

Work conditions:

Machine type: Spindle adaptation:
 Control: Hole type / bolt type:
 horizontal vertical Coolant-lubricant:
 Tool holder: Pressure: Internal coolant supply
 Cutting speed v_c : m/min Feed values: f_z : mm
 Speed n: rpm f_s : mm
 Tool life: (no. of threads) f_b : mm

Customer is already milling threads: Result / special information:
 Size:
 Manufacturer:
 Agenda:

Sketch:

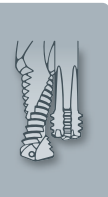
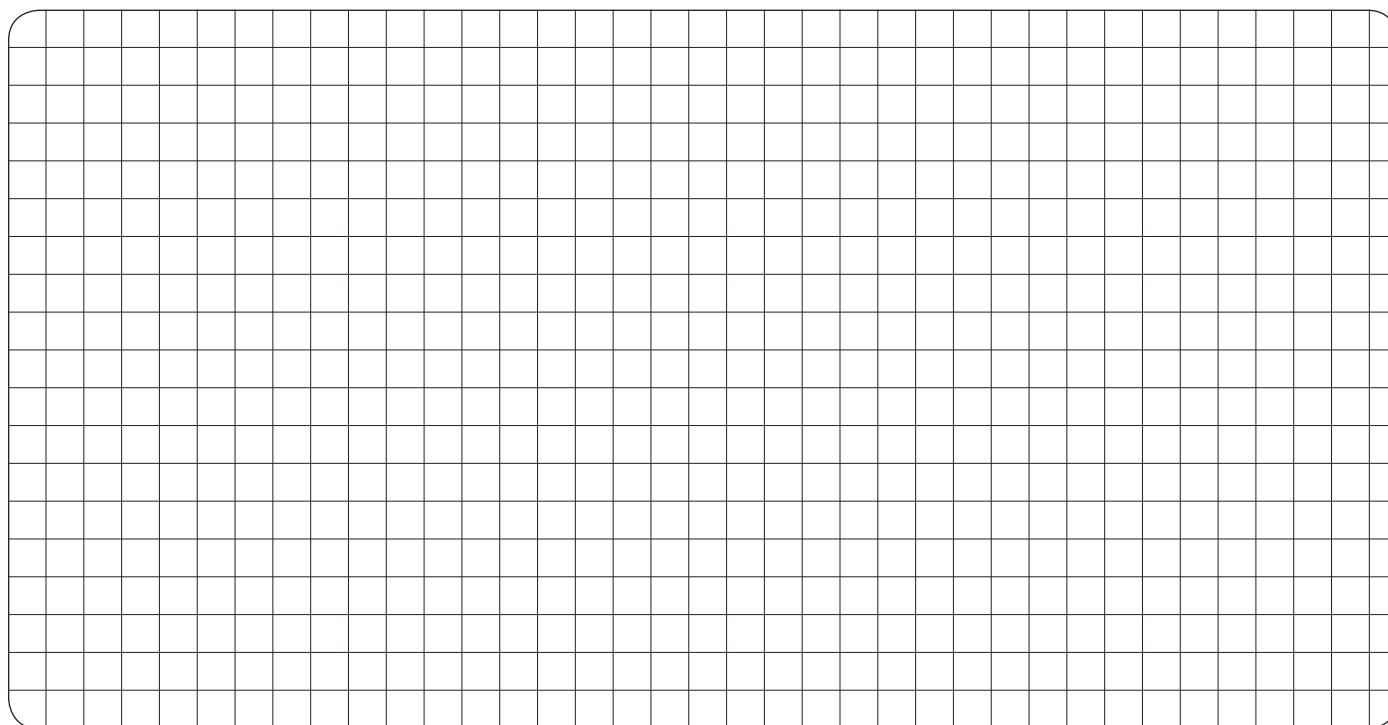

Filled in by: Date / signature:

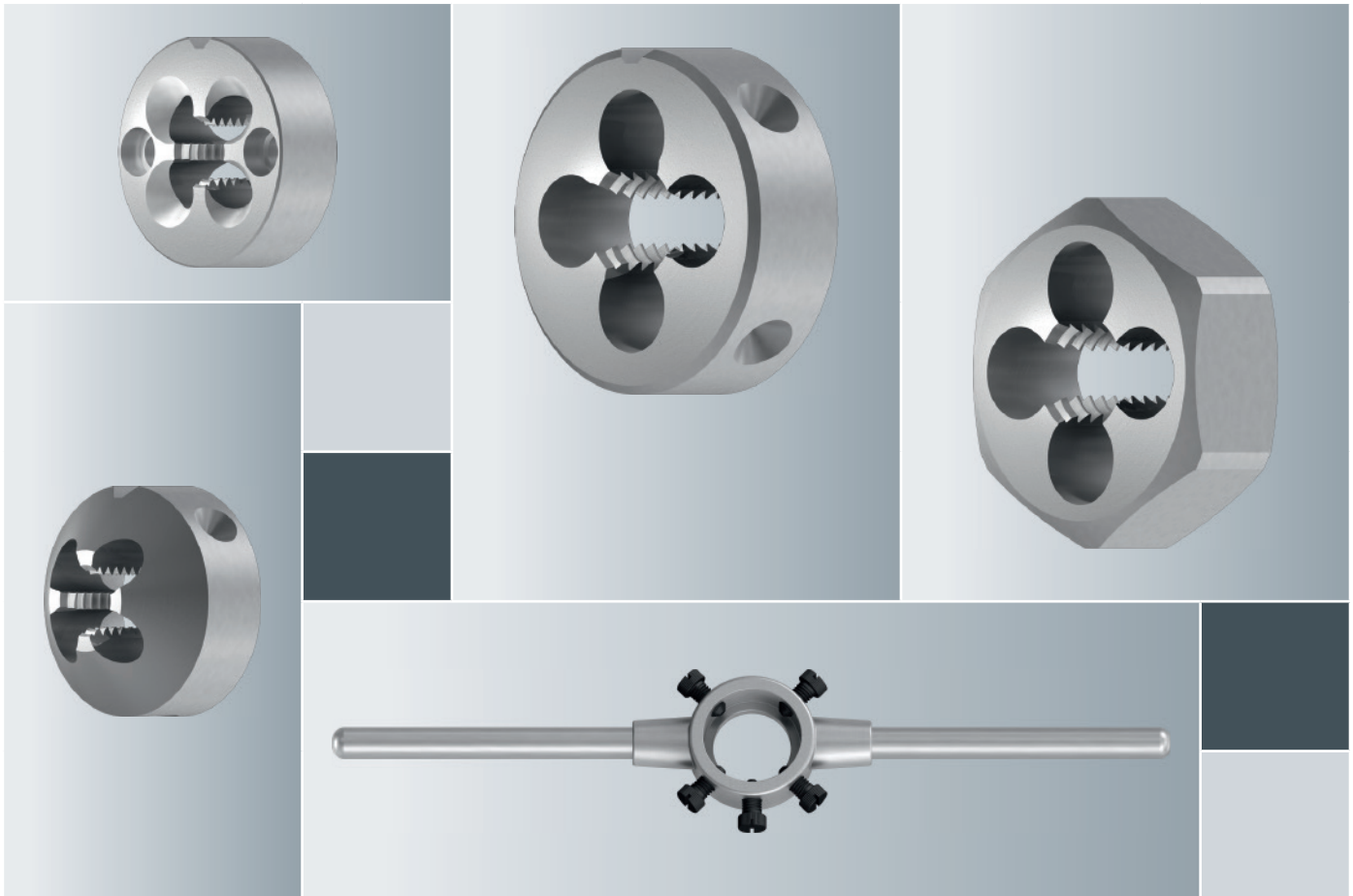

Schneideisen Dies



Seite · Page

Übersicht	Contents	475
Wegweiser und Schnittwerte	Product finder and cutting data	476 - 477
Produktseiten	Product pages	478 - 498
Technische Informationen	Technical information	499 - 506

- Product Finder
- Vc
- M
- MF
- UNC
- UNF
UNEF
- G
- NPT, NPTF
R
- BSW, BSF
- Tr, Tr-F
- Zubehör
Accessories
- Tech. Info



Runde
Schneideisen
Round
dies



Automaten-
Schneideisen
Dies
for automatic lathes



Glocken-
Schneideisen
Acorn
dies



Sechskant-
Schneideisen
Hexagon
dies



Seite · Page

478 - 479	480	481	482	M
484 - 485				MF
486				UNC
487				UNF
488				UNEF
489		490		G (BSP)
491				NPT
492				NPTF
493				R (BSPT)
494				BSW
495				BSF
496				Tr
497				Tr-F

Seite · Page



Kühlschmierstoffe
Coolant-lubricants

238 - 239



Schneideisenhalter
Die stocks

498



- Product Finder
- V_c
- M
- MF
- UNC
- UNF
UNEF
- G
- NPT, NPTF
R
- BSW, BSF
- Tr, Tr-F
- Zubehör
Accessories
- Tech. Info

Wegweiser und Schnittwerte

Bitte beachten:

Die in den jeweiligen Spalten angegebenen Schnittgeschwindigkeiten (v_c in m/min) sind Richtwerte, welche je nach Einsatzbedingungen (Material, Schmierung, Maschine, usw.) angepasst werden müssen.

Die Eignung ist folgendermaßen gekennzeichnet:

- Schneideisen sehr gut geeignet
- Schneideisen gut geeignet

= Anschnittlänge

Internationaler Werkstoffvergleich siehe Seite 838 - 851.

Product finder and cutting data

Please note:

The cutting speeds (v_c in m/min) listed in the respective columns are standard values which have to be adjusted to individual work conditions (material, lubrication, machine etc.).

The suitability is marked as follows:

- Die is very suitable
- Die is suitable

= Chamfer length

International comparison of materials, see page 838 - 851.

Einsatzgebiete – Material Applications – material		Material-Beispiele Material examples	Material-Nummern Material numbers	
P	Stahlwerkstoffe Kaltfließpressstähle, Baustähle, Automatenstähle, u.a.	Steel materials Cold-extrusion steels, Construction steels, Free-cutting steels, etc.	≤ 600 N/mm ²	
	2.1 Baustähle, Einsatzstähle, Stahlguss, u.a.	Construction steels, Cementation steels, Steel castings, etc.	≤ 800 N/mm ²	
	3.1 Einsatzstähle, Vergütungsstähle, Kaltarbeitsstähle, u.a.	Cementation steels, Heat-treatable steels, Cold work steels, etc.	≤ 1000 N/mm ²	
	4.1 Vergütungsstähle, Kaltarbeitsstähle, Nitrierstähle, u.a.	Heat-treatable steels, Cold work steels, Nitriding steels, etc.	≤ 1200 N/mm ²	
	5.1 Hochlegierte Stähle, Kaltarbeitsstähle, Warmarbeitsstähle, u.a.	High-alloyed steels, Cold work steels, Hot work steels, etc.	≤ 1400 N/mm ²	
M	Nichtrostende Stahlwerkstoffe 1.1 Ferritisch, martensitisch	Stainless steel materials Ferritic, martensitic	≤ 950 N/mm ²	
	2.1 Austenitisch	Austenitic	≤ 950 N/mm ²	
	3.1 Austenitisch-ferritisch (Duplex)	Austenitic-ferritic (Duplex)	≤ 1100 N/mm ²	
	4.1 Austenitisch-ferritisch hitzebeständig (Super Duplex)	Austenitic-ferritic heat-resistant (Super Duplex)	≤ 1250 N/mm ²	
	K	Gusswerkstoffe 1.1 Gusseisen mit Lamellengrafit (GJL)	Cast materials Cast iron with lamellar graphite (GJL)	100-250 N/mm ²
1.2		Cast iron with lamellar graphite (GJL)	250-450 N/mm ²	
2.1 Gusseisen mit Kugelgrafit (GJS)		Cast iron with nodular graphite (GJS)	350-500 N/mm ²	
2.2		Cast iron with nodular graphite (GJS)	500-900 N/mm ²	
3.1 Gusseisen mit Vermiculargrafit (GJV)		Cast iron with vermicular graphite (GJV)	300-400 N/mm ²	
3.2		Cast iron with vermicular graphite (GJV)	400-500 N/mm ²	
4.1 Temperguss (GTMW, GTMB)		Malleable cast iron (GTMW, GTMB)	250-500 N/mm ²	
4.2	Malleable cast iron (GTMW, GTMB)	500-800 N/mm ²		
N	Nichteisenwerkstoffe 1.1 Aluminium-Legierungen	Non ferrous materials Aluminium alloys	≤ 200 N/mm ²	
	1.2	Aluminium wrought alloys	≤ 350 N/mm ²	
	1.3	Aluminium wrought alloys	≤ 550 N/mm ²	
	1.4	Aluminium wrought alloys	Si ≤ 7%	
	1.5	Aluminium-Gusslegierungen	Aluminium cast alloys	7% < Si ≤ 12%
	1.6	Aluminium-Gusslegierungen	Aluminium cast alloys	12% < Si ≤ 17%
	2.1	Kupfer-Legierungen	Copper alloys	≤ 400 N/mm ²
	2.2	Reinkupfer, niedriglegiertes Kupfer	Pure copper, low-alloyed copper	≤ 550 N/mm ²
	2.3	Kupfer-Zink-Legierungen (Messing, langspanend)	Copper-zinc alloys (brass, long-chipping)	≤ 550 N/mm ²
	2.4	Kupfer-Zink-Legierungen (Messing, kurzspanend)	Copper-zinc alloys (brass, short-chipping)	≤ 800 N/mm ²
	2.5	Kupfer-Aluminium-Legierungen (Alubronze, langspanend)	Copper-aluminium alloys (alu bronze, long-chipping)	≤ 700 N/mm ²
	2.6	Kupfer-Zinn-Legierungen (Zinnbronze, langspanend)	Copper-tin alloys (tin bronze, long-chipping)	≤ 400 N/mm ²
	2.7	Kupfer-Zinn-Legierungen (Zinnbronze, kurzspanend)	Copper-tin alloys (tin bronze, short-chipping)	≤ 600 N/mm ²
	2.8	Kupfer-Sonderlegierungen	Special copper alloys	≤ 1400 N/mm ²
	3.1	Magnesium-Legierungen	Magnesium alloys	≤ 500 N/mm ²
	3.2	Magnesium-Knetlegierungen	Magnesium wrought alloys	≤ 500 N/mm ²
3.2	Magnesium-Gusslegierungen	Magnesium cast alloys	≤ 500 N/mm ²	
S	Kunststoffe 4.1 Duroplaste (kurzspanend)	Synthetics Duroplastics (short-chipping)		
	4.2 Thermoplaste (langspanend)	Thermoplastics (long-chipping)		
	4.3 Faserverstärkte Kunststoffe (Faseranteil ≤ 30%)	Fibre-reinforced synthetics (fibre content ≤ 30%)		
	4.4 Faserverstärkte Kunststoffe (Faseranteil > 30%)	Fibre-reinforced synthetics (fibre content > 30%)		
	Besondere Werkstoffe 5.1 Grafit	Special materials Graphite		
	5.2 Wolfram-Kupfer-Legierungen	Tungsten-copper alloys		
	5.3 Verbundwerkstoffe	Composite materials		
	Spezialwerkstoffe 1.1 Titan-Legierungen	Special materials Titanium alloys		
	1.2	Pure titanium		
	1.3	Titanium alloys		
H	Nickel-, Kobalt- und Eisen-Legierungen 2.1 Reinnickel	Nickel alloys, cobalt alloys and iron alloys Pure nickel	≤ 600 N/mm ²	
	2.2	Pure nickel	≤ 1000 N/mm ²	
	2.3	Nickel-Basis-Legierungen	Nickel-base alloys	≤ 1600 N/mm ²
	2.4	Nickel-Basis-Legierungen	Nickel-base alloys	≤ 1000 N/mm ²
	2.5	Kobalt-Basis-Legierungen	Cobalt-base alloys	≤ 1600 N/mm ²
	2.6	Kobalt-Basis-Legierungen	Cobalt-base alloys	≤ 1500 N/mm ²
	2.6	Eisen-Basis-Legierungen	Iron-base alloys	≤ 1500 N/mm ²
H	Harte Werkstoffe 1.1	Hard materials High strength steels, hardened steels, hard castings	44 - 50 HRC	
	1.2	High strength steels, hardened steels, hard castings	50 - 55 HRC	
	1.3	Hochfeste Stähle, gehärtete Stähle, Hartguss	55 - 60 HRC	
	1.4	Hochfeste Stähle, gehärtete Stähle, Hartguss	60 - 63 HRC	
	1.5	Hochfeste Stähle, gehärtete Stähle, Hartguss	63 - 66 HRC	
	1.5	Hochfeste Stähle, gehärtete Stähle, Hartguss	63 - 66 HRC	



										KEG		TRAPEZ		
	SE-B nor STEEL	SE-B gel STEEL	SE-B nor VA	SE-B gel VA	SE-B gel MS	SE-AUT-LD gel STEEL	SE-GLOCK gel STEEL	SE-GLOCK gel MS	SE-6KT nor STEEL		SE-KEG nor STEEL		TRAPEZ SE-B-nor STEEL	
	1,5	1,5	2	2	1	1,5	1	1	1,5		1,5		1,5-2	
	478	478	479	479	479	480	481		482					
	484	484	485		485									
	486	486												
	487	487												
	488	488												
	489	489			489			490			491			
											492			
											493			
	494													
	495												496	
													497	
	1 - 8	1 - 8	1 - 8	1 - 8		1 - 8	1 - 8		1 - 8		1 - 2		1 - 2 ¹⁾	1.1
	1 - 5	1 - 5	1 - 5	1 - 5		1 - 5	1 - 5		1 - 5		1 - 5			2.1
	1 - 3	1 - 3	1 - 3	1 - 3		1 - 3	1 - 3		1 - 3		1 - 2			3.1
														4.1
														5.1
			1 - 4	1 - 4										1.1
			1 - 4	1 - 4										2.1
														3.1
														4.1
														1.1
														1.2
														2.1
														2.2
														3.1
														3.2
														4.1
														4.2
		10 - 20				10 - 20								1.1
		10 - 20				10 - 20								1.2
		10 - 20				10 - 20								1.3
														1.4
														1.5
														1.6
	10 - 20	10 - 20				10 - 20	10 - 20							2.1
		10 - 20				10 - 25	10 - 20	10 - 20		10 - 25	1 - 5		1 - 2 ¹⁾	2.2
														2.3
														2.4
														2.5
														2.6
														2.7
														2.8
														3.1
														3.2
	1 - 8	1 - 8	2 - 10	2 - 10		1 - 8	1 - 8							4.1
														4.2
														4.3
														4.4
														5.1
														5.2
														5.3
														1.1
														1.2
														1.3
														2.1
														2.2
														2.3
														2.4
														2.5
														2.6
														1.1
														1.2
														1.3
														1.4
														1.5

- Product Finder
- V_c
- M
- MF
- UNC
- UNF
UNEF
- G
- NPT, NPTF
R
- BSW, BSF
- Tr, Tr-F
- Zubehör
Accessories
- Tech. Info

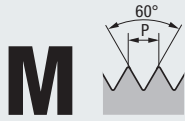

DIN 13

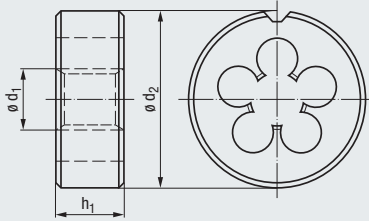

Vorarbeitendurchmesser $d \approx$
Preparatory diameter $d \approx$



DIN EN
22568

STEEL
Steel
materials

normal
standard

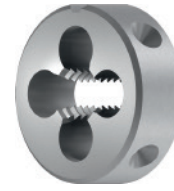

geläppt
lapped



Technische Informationen
Technical information

» 499 - 506

Toleranz · Tolerance

Schneidstoff · Cutting material



Einsatzgebiete – Material
Applications – material

» 476

6g

HSS

1,5

E / O

P 1.1-3.1

N 2.2, 4.2

6g

HSS

1,5

E / O

P 1.1-3.1

N 1.1-3

N 2.1-2, 4.2

Werkzeug-Ident · Tool ident

D0101000

D0101500

M	$\varnothing d_1$ mm	P mm	$\varnothing d_2$	x	h_1	$\varnothing d \approx$			Dimens.- Ident	SE-B nor STEEL	SE-B gel STEEL
						„4h“	„6g“	„6e“			
	1	0,25	16	x	5	0,98	0,97	0,93	.0010	•*)	•*)
	1,1	0,25	16	x	5	1,08	1,07	1,03	.0011	•*)	•*)
	1,2	0,25	16	x	5	1,18	1,17	1,13	.0012	•*)	•*)
	1,4	0,3	16	x	5	1,38	1,36	1,32	.0014	•*)	•*)
	1,6	0,35	16	x	5	1,57	1,54	1,51	.0016	•	•
	1,7	0,35	16	x	5	1,67	1,64	1,61	.0017	•	•
	1,8	0,35	16	x	5	1,77	1,74	1,71	.0018	•	•
	2	0,4	16	x	5	1,97	1,93	1,90	.0020	•	•
	2,2	0,45	16	x	5	2,16	2,13	2,10	.0022	•	•
	2,3	0,4	16	x	5	2,26	2,23	2,20	.0023	•	•
	2,5	0,45	16	x	5	2,46	2,43	2,40	.0025	•	•
	2,6	0,45	16	x	5	2,56	2,53	2,50	.0026	•	•
	3	0,5	20	x	5	2,96	2,92	2,89	.0030	•	•
	3,5	0,6	20	x	5	3,46	3,41	3,38	.0035	•	•
	4	0,7	20	x	5	3,95	3,90	3,87	.0040	•	•
	4,5	0,75	20	x	7	4,45	4,40	4,37	.0045	•	•
	5	0,8	20	x	7	4,95	4,90	4,86	.0050	•	•
	6	1	20	x	7	5,94	5,88	5,85	.0060	•	•
	7	1	25	x	9	6,94	6,88	6,85	.0070	•	•
	8	1,25	25	x	9	7,93	7,86	7,83	.0080	•	•
	9	1,25	25	x	9	8,93	8,86	8,83	.0090	•	•
	10	1,5	30	x	11	9,92	9,85	9,81	.0100	•	•
	11	1,5	30	x	11	10,92	10,85	10,81	.0110	•	•*)
	12	1,75	38	x	14	11,91	11,83	11,81	.0112	•	•
	14	2	38	x	14	13,91	13,82	13,78	.0114	•	•
	16	2	45	x	18	15,91	15,82	15,78	.0116	•	•
	18	2,5	45	x	18	17,89	17,79	17,75	.0118	•	•
	20	2,5	45	x	18	19,89	19,79	19,75	.0120	•	•
	22	2,5	55	x	22	21,89	21,79	21,75	.0122	•	•
	24	3	55	x	22	23,88	23,76	23,72	.0124	•	•
	27	3	65	x	25	26,88	26,76	26,72	.0127	•	•
	30	3,5	65	x	25	29,87	29,73	29,70	.0130	•	•
	33	3,5	65	x	25	32,87	32,73	32,70	.0133	•	•
	36	4	65	x	25	35,85	35,70	35,66	.0136	•	•
	39	4	75	x	30	38,85	38,70	38,66	.0139	•	•
	42	4,5	75	x	30	41,84	41,68	41,65	.0142	•	•
	45	4,5	90	x	36	44,84	44,68	44,65	.0145	•	•
	48	5	90	x	36	47,83	47,66	47,62	.0148	•	•
	52	5	90	x	36	51,83	51,66	51,62	.0152	•	•

*) \leq M1,4 Tol. 6h

Toleranzklasse 4h auf Anfrage
Tolerance class 4h upon request

STEEL Steel materials		VA Stainless steel materials		MS Copper-zinc alloys	
normal standard	normal standard	normal standard	geläpft lapped	geläpft lapped	
6e HSS	6g HSS LH	6g HSSE	6g HSSE	6g HSS	
1,5 E/O	1,5 E/O	2 E/O/P	2 E/O/P	1 E/O	
P 1.1-3.1 N 2.2, 4.2	P 1.1-3.1 N 2.2, 4.2	P 1.1-3.1 M 1.1-2.1 N 4.1	P 1.1-3.1 M 1.1-2.1 N 4.1	N 2.3	
D0101030	D0101050	D0103000	D0103500	D0102500	
SE-B nor STEEL „6e“	SE-B nor STEEL-LH	SE-B nor VA	SE-B gel VA	SE-B gel MS	
					M 1
					1,1
					1,2
					1,4
					1,6
					1,7
					1,8
●	●	●	●	●	2
○	○			○	2,2
		●	●	○	2,3
●	●	●	●	●	2,5
●	○			○	2,6
●	●	●	●	●	3
●	●	●	●	●	3,5
●	●	●	●	●	4
				●	4,5
●	●	●	●	●	5
●	●	●	●	●	6
●	●	●	●	●	7
●	●	●	●	●	8
				●	9
●	●	●	●	●	10
●	●	●	●	●	11
●	●	●	●	●	12
○	●	●	●	○	14
●	●	●	●	○	16
	●	●	●	○	18
	●	●	●	○	20
	●	●	●	○	22
	●	●	●	○	24
	●	●	●	○	27
		●	●		30
					33
					36
					39
					42
					45
					48
					52

- Product Finder
- Vc
- M
- MF
- UNC
- UNF
- UNEF
- G
- NPT, NPTF
- R
- BSW, BSF
- Tr, Tr-F
- Zubehör
- Accessories
- Tech. Info



Schnellwechsel-Einsätze für
runde Schneideisen Typ EM-SE
siehe Seite 777

Quick-change adapters for
round dies type EM-SE,
see page 777

● = Lagerwerkzeug, siehe Preisliste · Stock tool, see price list
○ = Kurzfristig lieferbar, Preis auf Anfrage · Available on short notice, price upon inquiry

- Product Finder
- V_c
- M
- MF
- UNC
- UNF
UNEF
- G
- NPT, NPTF
R
- BSW, BSF
- Tr, Tr-F
- Zubehör
Accessories
- Tech. Info

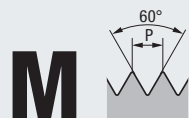

M
DIN 13

beidseitig verwendbar
to be used from both sides

Type
LD

STEEL
Steel
materials

geläpft
lapped

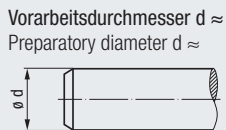
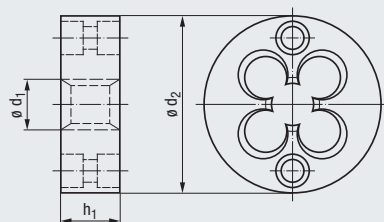

Toleranz · Tolerance
Schneidstoff · Cutting material

Technische Informationen
Technical information »» 499 - 506



- 6g
- HSS
- 1,5
- E / O

Einsatzgebiete – Material
Applications – material »» 476

- P 1.1-3.1
- N 1.1-3
- N 2.1-2, 4.2

Werkzeug-Ident · Tool ident

D0361500

	$\varnothing d_1$ mm	P mm	$\varnothing d_2$	x	h_1	$\varnothing d \approx$			Dimens.- Ident	SE-AUT-LD gel STEEL
						„4h“	„6g“	„6e“		
M	1	0,25	16	x	2	0,98	0,97	0,93	.0010	
	1,1	0,25	16	x	2	1,08	1,07	1,03	.0011	
	1,2	0,25	16	x	2	1,18	1,17	1,13	.0012	○*)
	1,4	0,3	16	x	2,6	1,38	1,36	1,32	.0014	●*)
	1,6	0,35	16	x	2,6	1,57	1,54	1,51	.0016	●
	1,7	0,35	16	x	2,6	1,67	1,64	1,61	.0017	●
	1,8	0,35	16	x	2,6	1,77	1,74	1,71	.0018	○
	2	0,4	16	x	3,5	1,97	1,93	1,90	.0020	●
	2,2	0,45	16	x	3,5	2,17	2,13	2,10	.0022	○
	2,3	0,4	16	x	3,5	2,27	2,23	2,20	.0023	●
	2,5	0,45	16	x	3,5	2,47	2,43	2,40	.0025	●
	3	0,5	16	x	3,5	2,97	2,92	2,89	.0030	●
	3,5	0,6	16	x	4	3,46	3,41	3,38	.0035	●
	4	0,7	16	x	5	3,96	3,90	3,87	.0040	●
	4,5	0,75	20	x	7	4,46	4,40	4,37	.0045	
	5	0,8	20	x	7	4,95	4,90	4,86	.0050	●
	6	1	20	x	7	5,94	5,88	5,85	.0060	●
	7	1	25	x	7	6,94	6,88	6,85	.0070	
	8	1,25	25	x	9	7,93	7,86	7,83	.0080	
	10	1,5	30	x	11	9,92	9,85	9,81	.0100	
	12	1,75	35	x	12	11,91	11,83	11,81	.0112	
	14	2	35	x	14	13,91	13,82	13,78	.0114	
	16	2	45	x	18	15,91	15,82	15,78	.0116	

*) \leq M1,4 Tol. 6h



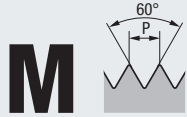

DIN 13

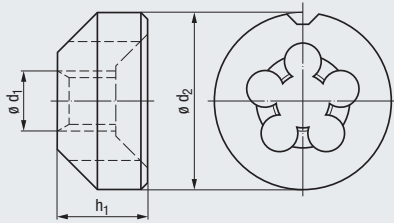

Vorarbeitdurchmesser $d \approx$
Preparatory diameter $d \approx$

STEEL
Steel materials

geläppt
lapped

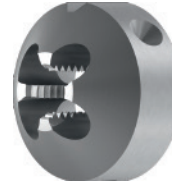

Technische Informationen
Technical information

» 499 - 506

Toleranz · Tolerance
Schneidstoff · Cutting material



6g

HSS

1

E / O

Einsatzgebiete – Material
Applications – material

» 476

P 1.1-3.1

N 2.2, 4.2

Werkzeug-Ident · Tool ident

D0301500

	$\varnothing d_1$ mm	P mm	$\varnothing d_2$	x	h_1	$\varnothing d \approx$			Dimens.- Ident	SE-GLOCK gel STEEL
						„4h“	„6g“	„6e“		
M	2	0,4	16	x	8	1,97	1,93	1,90	.0020	●
	2,5	0,45	16	x	8	2,47	2,43	2,40	.0025	●
	3	0,5	16	x	8	2,97	2,92	2,89	.0030	●
	3,5	0,6	16	x	9,5	3,46	3,41	3,38	.0035	○
	4	0,7	16	x	9,5	3,96	3,90	3,87	.0040	●
	5	0,8	20	x	9,5	4,95	4,90	4,86	.0050	●
	6	1	20	x	9,5	5,94	5,88	5,85	.0060	●
	8	1,25	25	x	14	7,93	7,86	7,83	.0080	●

Product
Finder

Vc

M

MF

UNC

UNF
UNEF

G

NPT, NPTF
R

BSW, BSF

Tr, Tr-F

Zubehör
Accessories

Tech. Info



Kühlschmierstoffe siehe Seite 238 - 239

Coolant-lubricants, see page 238 - 239

- Product Finder
- Vc
- M**
- MF
- UNC
- UNF
UNEF
- G
- NPT, NPTF
R
- BSW, BSF
- Tr, Tr-F
- Zubehör
Accessories
- Tech. Info

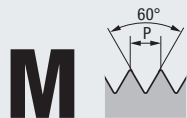

M
DIN 13

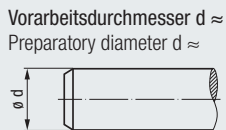
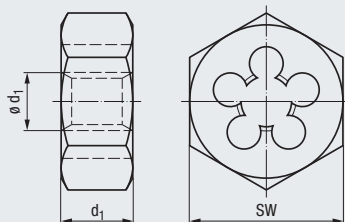

DIN 382

STEEL
Steel materials

normal standard

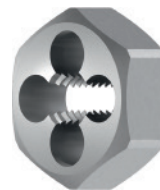

Technische Informationen
Technical information »» 499 - 506

Toleranz · Tolerance
Schneidstoff · Cutting material



Einsatzgebiete – Material
Applications – material »» 476

- 6g
- HSS
- 1,5
- E / O
- P 1.1-3.1**

Werkzeug-Ident · Tool ident

D0401000

	ø d ₁ mm	P mm	SW	x	h ₁	ø d ≈			Dimens.- Ident	SE-6KT nor STEEL
						„4h“	„6g“	„6e“		
M	3	0,5	18	x	5	2,97	2,92	2,89	.0030	●
	3,5	0,6	18	x	5	3,46	3,41	3,38	.0035	○
	4	0,7	18	x	5	3,96	3,90	3,87	.0040	●
	5	0,8	18	x	7	4,95	4,90	4,86	.0050	●
	6	1	18	x	7	5,94	5,88	5,85	.0060	●
	7	1	21	x	9	6,94	6,88	6,85	.0070	○
	8	1,25	21	x	9	7,93	7,86	7,83	.0080	●
	10	1,5	27	x	11	9,92	9,85	9,81	.0100	●
	12	1,75	36	x	14	11,91	11,83	11,81	.0112	●
	14	2	36	x	14	13,91	13,82	13,78	.0114	●
	16	2	41	x	18	15,91	15,82	15,78	.0116	●
	18	2,5	41	x	18	17,89	17,79	17,75	.0118	●
	20	2,5	41	x	18	19,89	19,79	19,75	.0120	●
	22	2,5	50	x	22	21,89	21,79	21,75	.0122	●
	24	3	50	x	22	23,88	23,76	23,72	.0124	●
	27	3	60	x	25	26,88	26,76	26,72	.0127	●
30	3,5	60	x	25	29,87	29,73	29,70	.0130	●	
33	3,5	60	x	25	32,87	32,73	32,70	.0133	●	
36	4	60	x	25	35,85	35,70	35,66	.0136	●	



Product
Finder

Vc

M

MF

UNC

UNF

G

NPT, NPTF
R

BSW, BSF

Tr, Tr-F

Zubehör
Accessories

Tech. Info

EMUGE bietet ein umfangreiches Programm an Gewindewalzrollen, Schneckenwalzrollen, Rändelrollen und Kerbverzahnungsrollen für praktisch alle Bearbeitungsfälle.

EMUGE offers you a comprehensive programme of thread rolls, worm rolls, knurling rolls and serration rolls for practically all application cases.

Verfahrensmerkmale:

- Spanloses Verfahren
- Außenbearbeitung
- Erzeugung der Profilkonturen durch Materialverdrängung
- Walzen-Grundwerkstoff ist hochlegierter Werkzeugstahl

Voraussetzungen:

- Werkstoffe mit einer Bruchdehnung $\geq 8\%$
- Speziell abgestimmte Vorarbeitsdurchmesser der Rohlinge zum Walzen erforderlich

Vorteile:

- Rollglatte Oberflächen durch Gefügeverdichtung
- Oberflächengüte $R_a 0,2$ am gewalzten Profil
- Höhere Korrosionsbeständigkeit durch kleinere Reaktionsflächen
- Ununterbrochener Faserverlauf
- Erhöhte statische und dynamische Festigkeit des Profils
- Hohe Form- und Maßgenauigkeit
- Erhebliche Werkstoffersparnis, da nicht vom Außendurchmesser des Werkstücks, sondern vom Flanken- bzw. Vorarbeitsdurchmesser ausgegangen wird
- Kurze Bearbeitungsdauer

Somit können gewalzte Gewinde größeren Belastungen ausgesetzt werden. Sie besitzen höhere Verschleißfestigkeit und sind korrosionsbeständiger. Eine Steigerung der Wirtschaftlichkeit bei der Gewindefertigung durch extrem kurze Fertigungszeiten ist ein weiterer Vorteil, der besondere Beachtung verdient.

Nachteile:

- Nicht vollständig ausgeformter Außendurchmesser
- Spezialmaschinen erforderlich

Für weitere Informationen kontaktieren Sie bitte den für Sie zuständigen Vertriebspartner.

Process characteristics:

- Chipless process
- External machining
- Production of profile contours by material displacement
- Rolls made of high-alloyed tool steel

Requirements:

- Workpiece materials with a breaking elongation $\geq 8\%$
- Specially adjusted blank diameters are necessary for rolling

Advantages:

- Smooth rolled surfaces achieved by densification of the material structure
- Surface quality grade $R_a 0.2$ on the rolled profile
- Increased corrosion resistance due to reduced reaction surfaces
- Uninterrupted grain structure
- Increased static and dynamic strength of the profile
- High dimensional and form precision
- Considerable material savings, since work does not start from the major diameter of the workpiece but from its pitch, or preparatory diameter
- Short machining times

This means that rolled threads can better withstand stress: they show increased wear resistance, and are better protected against corrosion. Another advantage which deserves attention lies in the possibility of improving economic efficiency in thread production by the extremely short machining times which are common in thread rolling.

Disadvantages:

- Incompletely formed major diameter
- Special machines are necessary

For further information please get in touch with your sales contact.

- Product Finder
- Vc
- M
- MF**
- UNC
- UNF
UNEF
- G
- NPT, NPTF
R
- BSW, BSF
- Tr, Tr-F
- Zubehör
Accessories
- Tech. Info



DIN 13

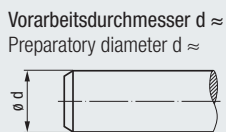
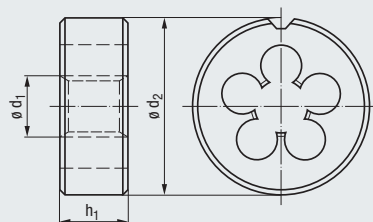

DIN EN
22568

STEEL
Steel
materials

normal
standard

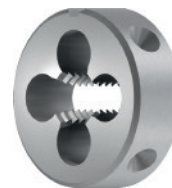

geläppt
lapped

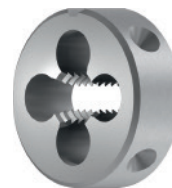

Technische Informationen
Technical information

» 499 - 506

Toleranz · Tolerance
Schneidstoff · Cutting material



Einsatzgebiete – Material
Applications – material

» 476





6g	6g
HSS	HSS
1,5	1,5
E / O	E / O
P 1.1-3.1	P 1.1-3.1
N 2.2, 4.2	N 1.1-3
	N 2.1-2, 4.2

Werkzeug-Ident · Tool ident

D0101000

D0101500

	$\varnothing d_1$ mm	P mm	$\varnothing d_2$	x	h_1	$\varnothing d \approx$			Dimens.- Ident	SE-B nor STEEL	SE-B gel STEEL
						„4h“	„6g“	„6e“			
M	2,5	x 0,35	16	x 5		2,47	2,44	—	.0196	●	●
	2,6	x 0,35	16	x 5		2,57	2,54	—	.0199	○	○
	3	x 0,35	20	x 5		2,97	2,94	—	.0202	●	●
	3,5	x 0,35	20	x 5		3,47	3,44	—	.0205	●	●
	4	x 0,35	20	x 5		3,97	3,94	—	.0209	●	●
	4	x 0,5	20	x 5		3,96	3,92	3,89	.0210	●	●
	5	x 0,5	20	x 5		4,96	4,92	4,89	.0218	●	●
	6	x 0,5	20	x 5		5,96	5,92	5,89	.0228	●	●
	6	x 0,75	20	x 7		5,95	5,90	5,87	.0229	●	●
	7	x 0,75	25	x 9		6,95	6,90	6,87	.0239	●	●
	8	x 0,5	25	x 9		7,96	7,92	7,89	.0249	●	●
	8	x 0,75	25	x 9		7,95	7,90	7,87	.0250	●	●
	8	x 1	25	x 9		7,94	7,88	7,85	.0251	●	●
	9	x 0,75	25	x 9		8,95	8,90	8,87	.0262	●	●
	9	x 1	25	x 9		8,94	8,88	8,85	.0263	●	●
	10	x 0,75	30	x 11		9,95	9,90	9,87	.0275	●	●
	10	x 1	30	x 11		9,94	9,88	9,85	.0276	●	●
	10	x 1,25	30	x 11		9,93	9,86	9,83	.0277	●	●
	11	x 1	30	x 11		10,94	10,88	10,85	.0288	●	●
	12	x 1	38	x 10		11,94	11,88	11,85	.0301	●	●
	12	x 1,25	38	x 10		11,93	11,86	11,83	.0302	●	●
	12	x 1,5	38	x 10		11,92	11,85	11,81	.0303	●	●
	13	x 1	38	x 10		12,94	12,88	12,85	.0315	●	●
	14	x 1	38	x 10		13,94	13,88	13,85	.0329	●	●
	14	x 1,25	38	x 10		13,93	13,86	13,83	.0330	●	●
	14	x 1,5	38	x 10		13,92	13,85	13,81	.0331	●	●
	15	x 1	38	x 10		14,94	14,88	14,85	.0343	●	●
	15	x 1,5	38	x 10		14,92	14,85	14,81	.0345	●	●
	16	x 1	45	x 14		15,94	15,88	15,85	.0357	●	●
	16	x 1,5	45	x 14		15,92	15,85	15,81	.0359	●	●
	18	x 1	45	x 14		17,94	17,88	17,85	.0388	●	●
	18	x 1,5	45	x 14		17,92	17,85	17,81	.0390	●	●
	18	x 2	45	x 14		17,91	17,82	17,78	.0391	●	●
	20	x 1	45	x 14		19,94	19,88	19,85	.0420	●	●
	20	x 1,5	45	x 14		19,92	19,85	19,81	.0422	●	●
	20	x 2	45	x 14		19,91	19,82	19,78	.0423	●	●
	22	x 1	55	x 16		21,94	21,88	21,85	.0436	●	●
	22	x 1,5	55	x 16		21,92	21,85	21,81	.0438	●	●
	22	x 2	55	x 16		21,91	21,82	21,78	.0439	●	●
	24	x 1	55	x 16		23,94	23,88	23,85	.0450	●	●
	24	x 1,5	55	x 16		23,92	23,85	23,81	.0452	●	●
	24	x 2	55	x 16		23,91	23,82	23,78	.0453	●	●
	25	x 1	55	x 16		24,94	24,88	24,85	.0456	●	●
	25	x 1,5	55	x 16		24,92	24,85	24,81	.0458	●	●
	26	x 1,5	55	x 16		25,92	25,85	25,81	.0464	●	●
	27	x 1	65	x 18		26,94	26,88	26,85	.0468	●	●
	27	x 1,5	65	x 18		26,92	26,85	26,81	.0470	●	●
	27	x 2	65	x 18		26,91	26,82	26,78	.0471	●	●
	28	x 1	65	x 18		27,94	27,88	27,85	.0474	●	●
	28	x 1,5	65	x 18		27,92	27,85	27,81	.0476	●	●
	30	x 1	65	x 18		29,94	29,88	29,85	.0488	●	●
	30	x 1,5	65	x 18		29,92	29,85	29,81	.0490	●	●
	30	x 2	65	x 18		29,91	29,82	29,78	.0491	●	●

STEEL Steel materials		VA Stainless steel materials	MS Copper-zinc alloys	
normal standard	normal standard	normal standard	geläpft lapped	
				
6e HSS	6g HSS LH	6g HSSE	6g HSS	
1,5 E/O	1,5 E/O	2 E/O/P	1 E/O	
P 1.1-3.1 N 2.2, 4.2	P 1.1-3.1 N 2.2, 4.2	P 1.1-3.1 M 1.1-2.1 N 4.1	N 2.3	
D0101030	D0101050	D0103000	D0102500	
SE-B nor STEEL „6e“	SE-B nor STEEL-LH	SE-B nor VA	SE-B gel MS	
				M 2,5 x 0,35
				2,6 x 0,35
				3 x 0,35
				3,5 x 0,35
				4 x 0,35
	•			4 x 0,5
	•			5 x 0,5
	•		•	6 x 0,5
•	•	•	•	6 x 0,75
			•	7 x 0,75
			○	8 x 0,5
•	•	•	•	8 x 0,75
			•	8 x 1
				9 x 0,75
				9 x 1
•	•	•	•	10 x 0,75
				10 x 1
				10 x 1,25
•	•	•	•	11 x 1
				12 x 1
•	•	•	•	12 x 1,25
•	•	•	•	12 x 1,5
	•		•	13 x 1
	•		•	14 x 1
•	•	•	•	14 x 1,25
			•	14 x 1,5
			•	15 x 1
			•	15 x 1,5
•	•	•	•	16 x 1
			•	16 x 1,5
	•	•	•	18 x 1
			•	18 x 1,5
			•	18 x 2
	•	•	•	20 x 1
			•	20 x 1,5
			•	20 x 2
	•	•	•	22 x 1
			•	22 x 1,5
			•	22 x 2
	•	•	•	24 x 1
			•	24 x 1,5
			•	24 x 2
				25 x 1
			○	25 x 1,5
				26 x 1,5
				27 x 1
				27 x 1,5
				27 x 2
				28 x 1
				28 x 1,5
				30 x 1
				30 x 1,5
				30 x 2

- Product Finder
- Vc
- M
- MF
- UNC
- UNF
UNEF
- G
- NPT, NPTF
R
- BSW, BSF
- Tr, Tr-F
- Zubehör
Accessories
- Tech. Info



• = Lagerwerkzeug, siehe Preisliste · Stock tool, see price list
○ = Kurzfristig lieferbar, Preis auf Anfrage · Available on short notice, price upon inquiry

- Product Finder
- Vc
- M
- MF
- UNC**
- UNF
UNEF
- G
- NPT, NPTF
R
- BSW, BSF
- Tr, Tr-F
- Zubehör
Accessories
- Tech. Info

UNC

ASME B1.1



DIN EN
22568

STEEL
Steel
materials

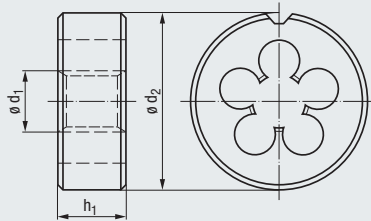

Vorarbeitsdurchmesser $d \approx$
Preparatory diameter $d \approx$

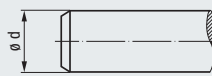

normal
standard

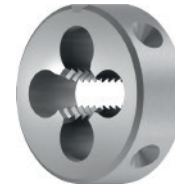

geläppt
lapped



Technische Informationen
Technical information

» 499 - 506

Toleranz · Tolerance
Schneidstoff · Cutting material



Einsatzgebiete – Material
Applications – material

» 476

2A
HSS
1,5
E / O

2A
HSS
1,5
E / O

P 1.1-3.1
N 2.2, 4.2

P 1.1-3.1
N 1.1-3
N 2.1-2, 4.2

Werkzeug-Ident · Tool ident

D0101000

D0101500

Nr.	$\varnothing d_1$		P Gg/1" (tpi)	$\varnothing d_2$	x	h_1	$\varnothing d \approx$		Dimens.- Ident	SE-B nor STEEL	SE-B gel STEEL
	inch	inch					„2A“	„3A“			
Nr. 1	0.0730		64	16	x	5	1,79	1,81	.5000	●	●
Nr. 2	0.0860		56	16	x	5	2,12	2,14	.5001	●	●
Nr. 3	0.0990		48	16	x	5	2,44	2,46	.5002	●	●
Nr. 4	0.1120		40	16	x	5	2,76	2,78	.5003	●	●
Nr. 5	0.1250		40	20	x	5	3,09	3,11	.5004	●	●
Nr. 6	0.1380		32	20	x	7	3,41	3,43	.5005	●	●
Nr. 8	0.1640		32	20	x	7	4,07	4,09	.5006	●	●
Nr. 10	0.1900		24	20	x	7	4,71	4,73	.5007	●	●
Nr. 12	0.2160		24	20	x	7	5,37	5,39	.5008	●	●
1/4	0.2500		20	20	x	7	6,22	6,25	.5009	●	●
5/16	0.3125		18	25	x	9	7,80	7,83	.5010	●	●
3/8	0.3750		16	30	x	11	9,37	9,41	.5011	●	●
7/16	0.4375		14	30	x	11	10,95	10,98	.5012	●	●
1/2	0.5000		13	38	x	14	12,52	12,56	.5013	●	●
9/16	0.5625		12	38	x	14	14,10	14,14	.5014	●	●
5/8	0.6250		11	45	x	18	15,68	15,72	.5015	●	●
3/4	0.7500		10	45	x	18	18,84	18,89	.5016	●	●
7/8	0.8750		9	55	x	22	22,00	22,05	.5017	●	●
1"	1.0000		8	55	x	22	25,16	25,21	.5018	●	●
1 1/8	1.1250		7	65	x	25	28,31	28,37	.5019	●	●
1 1/4	1.2500		7	65	x	25	31,49	31,54	.5020	●	●
1 3/8	1.3750		6	65	x	25	34,63	34,69	.5021	●	●
1 1/2	1.5000		6	75	x	30	37,80	37,87	.5022	●	●
1 3/4	1.7500		5	90	x	36	44,12	44,19	.5023	●	●
2"	2.0000		4 1/2	90	x	36	50,45	50,52	.5024	●	●

Toleranzklasse 3A und 1A auf Anfrage
Tolerance classes 3A and 1A upon request



Schneideisenhalter für runde
Schneideisen siehe Seite 498

Die stocks for round dies,
see page 498

UNF

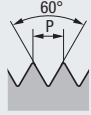

ASME B1.1

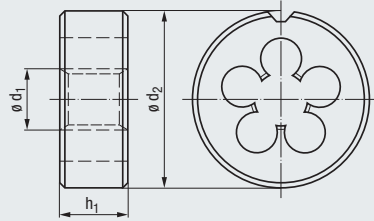

Vorarbeitdurchmesser $d \approx$
Preparatory diameter $d \approx$



DIN EN
22568

STEEL
Steel
materials

normal
standard

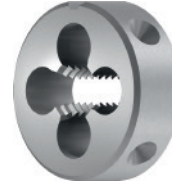

geläpft
lapped



Technische Informationen
Technical information

» 499 - 506

Toleranz · Tolerance
Schneidstoff · Cutting material



Einsatzgebiete – Material
Applications – material

» 476

2A

HSS

1,5

E / O

P 1.1-3.1

N 2.2, 4.2

2A

HSS

1,5

E / O

P 1.1-3.1

N 1.1-3

N 2.1-2, 4.2

Werkzeug-Ident · Tool ident

D0101000

D0101500

$\varnothing d_1$ inch	inch	P Gg/1" (tpi)	$\varnothing d_2$ x h_1	$\varnothing d \approx$		Dimens.- Ident	SE-B nor STEEL	SE-B gel STEEL
				„2A“	„3A“			
Nr. 0	0.0600	80	16 x 5	1,47	1,49	.5033	●	●
Nr. 1	0.0730	72	16 x 5	1,80	1,81	.5034	●	●
Nr. 2	0.0860	64	16 x 5	2,12	2,14	.5035	●	●
Nr. 3	0.0990	56	16 x 5	2,44	2,46	.5036	●	●
Nr. 4	0.1120	48	16 x 5	2,77	2,79	.5037	●	●
Nr. 5	0.1250	44	20 x 5	3,10	3,12	.5038	●	●
Nr. 6	0.1380	40	20 x 5	3,42	3,44	.5039	●	●
Nr. 8	0.1640	36	20 x 7	4,08	4,10	.5040	●	●
Nr. 10	0.1900	32	20 x 7	4,73	4,75	.5041	●	●
Nr. 12	0.2160	28	20 x 7	5,38	5,40	.5042	●	●
1/4	0.2500	28	20 x 7	6,24	6,27	.5043	●	●
5/16	0.3125	24	25 x 9	7,82	7,85	.5044	●	●
3/8	0.3750	24	30 x 11	9,41	9,43	.5045	●	●
7/16	0.4375	20	30 x 11	10,98	11,01	.5046	●	●
1/2	0.5000	20	38 x 10	12,56	12,60	.5047	●	●
9/16	0.5625	18	38 x 10	14,14	14,18	.5048	●	●
5/8	0.6250	18	45 x 14	15,73	15,77	.5049	●	●
3/4	0.7500	16	45 x 14	18,89	18,93	.5050	●	●
7/8	0.8750	14	55 x 16	22,05	22,09	.5051	●	●
1"	1.0000	12	55 x 16	25,21	25,26	.5052	●	●
1 1/8	1.1250	12	65 x 18	28,38	28,43	.5053	●	●
1 1/4	1.2500	12	65 x 18	31,55	31,60	.5054	●	●
1 3/8	1.3750	12	65 x 18	34,73	34,78	.5055	●	●
1 1/2	1.5000	12	75 x 20	37,90	37,95	.5056	●	●

Toleranzklasse 3A und 1A auf Anfrage
Tolerance classes 3A and 1A upon request

- Product Finder
- Vc
- M
- MF
- UNC
- UNF
- UNE
- G
- NPT, NPTF
- R
- BSW, BSF
- Tr, Tr-F
- Zubehör
- Accessories
- Tech. Info



- Product Finder
- Vc
- M
- MF
- UNC
- UNF
UNEF
- G
- NPT, NPTF
R
- BSW, BSF
- Tr, Tr-F
- Zubehör
Accessories
- Tech. Info

UNEF



≈DIN EN
22568

STEEL
Steel
materials

ASME B1.1

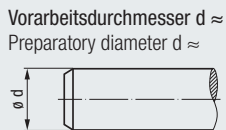
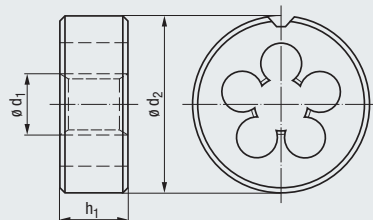

normal
standard

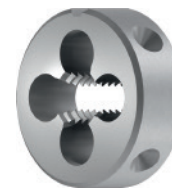

geläppt
lapped

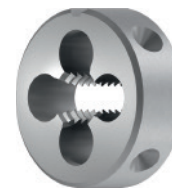

Technische Informationen
Technical information

» 499 - 506

Toleranz · Tolerance
Schneidstoff · Cutting material



2A

HSS

1,5

E / O

2A

HSS

1,5

E / O

Einsatzgebiete – Material
Applications – material

» 476

P 1.1-3.1

N 2.2, 4.2

P 1.1-3.1

N 1.1-3

N 2.1-2, 4.2

Werkzeug-Ident · Tool ident

D0101000

D0101500

Nr.	$\varnothing d_1$		P Gg/1" (tpi)	$\varnothing d_2$ x h_1	$\varnothing d \approx$		Dimens.- Ident	SE-B nor STEEL	SE-B gel STEEL
	inch	inch			„2A“	„3A“			
Nr. 12	0.2160		32	20 x 7	5,39	5,41	.5057	●	●
1/4	0.2500		32	20 x 7	6,25	6,27	.5058	●	●
5/16	0.3125		32	25 x 9	7,84	7,86	.5059	●	●
3/8	0.3750		32	30 x 11	9,42	9,45	.5060	●	●
7/16	0.4375		28	30 x 11	11,00	11,03	.5061	●	●
1/2	0.5000		28	38 x 10	12,59	12,62	.5062	●	●
9/16	0.5625		24	38 x 10	14,17	14,20	.5063	●	●
5/8	0.6250		24	45 x 14	15,75	15,78	.5064	●	●
3/4	0.7500		20	45 x 14	18,91	18,95	.5066	●	●
7/8	0.8750		20	55 x 16	22,09	22,12	.5068	●	●
1"	1.0000		20	55 x 16	25,26	25,30	.5070	●	●

Toleranzklasse 3A und 1A auf Anfrage
Tolerance classes 3A and 1A upon request



G (BSP)

DIN EN ISO 228

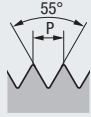

DIN EN 24231

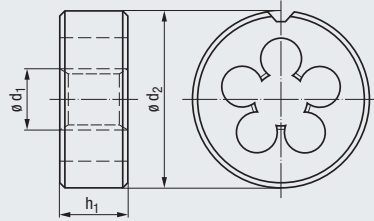

Vorarbeitdurchmesser $\varnothing d \approx$
Preparatory diameter $\varnothing d \approx$

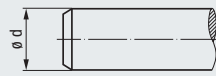

Technische Informationen
Technical information

» 499 - 506

Toleranz · Tolerance
Schneidstoff · Cutting material



Einsatzgebiete – Material
Applications – material

» 476

Werkzeug-Ident · Tool ident

Nenngröße
Nom. size

$\varnothing d_1$	$\varnothing d_1$ mm	P Gg/1" (tpi)	$\varnothing d_2$ x h_1	$\varnothing d \approx$ Class A	Dimens.- Ident	STEEL Steel materials		
						normal standard	geläppt lapped	MS Copper-zinc alloys
G	1/16	7,72	28	25 x 9	7,62			
	1/8	9,73	28	30 x 11	9,62	●	●	●
	1/4	13,16	19	38 x 10	13,03	●	●	●
	3/8	16,66	19	45 x 14	16,54	●	●	●
	1/2	20,96	14	45 x 14	20,81	●	●	●
	5/8	22,91	14	55 x 16	22,77	●	●	●
	3/4	26,44	14	55 x 16	26,30	●	●	●
	7/8	30,20	14	65 x 18	30,06	●	●	●
	1"	33,25	11	65 x 18	33,07	●	●	●
	1 1/8	37,90	11	75 x 20	37,72	●	●	●
	1 1/4	41,91	11	75 x 20	41,73	●	●	●
	1 3/8	44,32	11	90 x 22	44,14	●	●	●
	1 1/2	47,80	11	90 x 22	47,62	●	●	●
	1 3/4	53,75	11	90 x 22	53,57	●	●	●
	2"	59,61	11	105 x 22	59,43	●	●	●

1) Bei Bearbeitung von dünnwandigen Messingrohren bitten wir um nähere Angaben (Werkstückskizze)
If thin-walled brass tubes are to be cut we need more technical details or a sketch of the workpiece

- Product Finder
- Vc
- M
- MF
- UNC
- UNF
- UNEF
- G**
- NPT, NPTF
- R
- BSW, BSF
- Tr, Tr-F
- Zubehör
- Accessories
- Tech. Info



- Product Finder
- V_c
- M
- MF
- UNC
- UNF
UNEF
- G**
- NPT, NPTF
R
- BSW, BSF
- Tr, Tr-F
- Zubehör
Accessories
- Tech. Info



DIN EN ISO 228

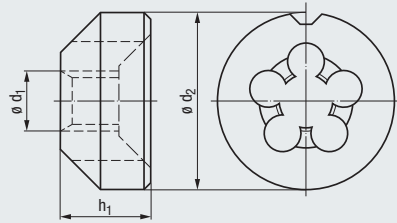

Vorarbeitendurchmesser $d \approx$
Preparatory diameter $d \approx$

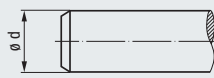

MS
Copper-zinc
alloys

geläppt
lapped

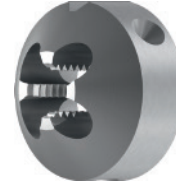

Toleranz · Tolerance
Schneidstoff · Cutting material

Class A
HSS

Technische Informationen
Technical information ▶▶ 499 - 506



1
E / O

Einsatzgebiete – Material
Applications – material ▶▶ 476

N 2.3

Werkzeug-Ident · Tool ident

D0302500

Nenngröße Nom. size						$\varnothing d \approx$ Class A	Dimens.- Ident	SE-GLOCK gel MS
$\varnothing d_1$	$\varnothing d_1$ mm	P Gg/1" (tpi)	$\varnothing d_2$	x	h_1			
G 1/8	9,73	28	25	x	14	9,62	.4035	●
1/4	13,16	19	30	x	18	13,03	.4036	●
3/8	16,66	19	38	x	20	16,54	.4037	●
1/2	20,96	14	45	x	24	20,81	.4038	●
3/4	26,44	14	55	x	28	26,30	.4040	●
1"	33,25	11	65	x	30	33,07	.4042	●





ANSI/ASME B1.20.1

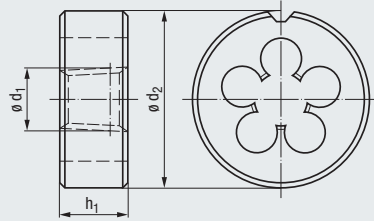

Bolzen-Vorarbeitsmaße im Kegel 1:16
Preparatory bolt dimensions on taper 1:16

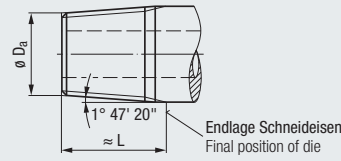

STEEL
Steel materials

normal standard

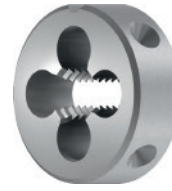

Technische Informationen
Technical information

» 499 - 506

Toleranz · Tolerance
Schneidstoff · Cutting material

HSS



1,5

O / P

Einsatzgebiete – Material
Applications – material

» 476

P 1.1-3.1

N 2.3

Werkzeug-Ident · Tool ident

D0191000

Nenngröße
Nom. size

$\varnothing d_1$	P Gg/1" (tpi)	$\varnothing d_2$	x	h_1	$\varnothing D_a$ min.	$\varnothing D_a$ max.	$\approx L$	Dimens.- Ident	SE-KEG nor STEEL	
									●	○
1/16	27	25	x	9	7,52	7,64	8,3	.5763	●	
1/8	27	30	x	11	9,87	9,99	8,4	.5764	●	
1/4	18	38	x	14	13,10	13,26	12,7	.5765	●	
3/8	18	45	x	14	16,52	16,67	12,9	.5766	●	
1/2	14	45	x	18	20,55	20,71	16,8	.5767	●	
3/4	14	55	x	22	25,87	26,03	17,0	.5768	●	
1"	11 1/2	65	x	25	32,42	32,59	21,2	.5769	●	
1 1/4	11 1/2	75	x	26	41,14	41,32	21,9	.5770	●	
1 1/2	11 1/2	90	x	27	47,21	47,39	22,3	.5771	●	
2"	11 1/2	105	x	28	59,25	59,42	23,1	.5772	●	

Product Finder

Vc

M

MF

UNC

UNF
UNEF

G

NPT NPTF
R

BSW, BSF

Tr, Tr-F

Zubehör
Accessories

Tech. Info



- Product Finder
- Vc
- M
- MF
- UNC
- UNF
UNEF
- G
- NPT NPTF
R

NPTF



ANSI B1.20.3

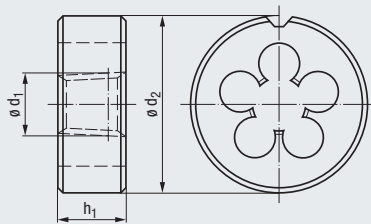

Bolzen-Vorabmaße im Kegel 1:16
Preparatory bolt dimensions on taper 1:16

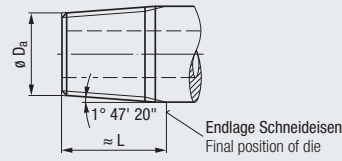

STEEL
Steel materials

normal standard



Toleranz · Tolerance

Schneidstoff · Cutting material

HSS

Technische Informationen
Technical information

» 499 - 506



1,5

0 / P

Zubehör
Accessories

Einsatzgebiete – Material
Applications – material

» 476

P 1.1-3.1

N 2.3

Werkzeug-Ident · Tool ident

D0191000

Nenngröße Nom. size					$\varnothing D_a$ min.	$\varnothing D_a$ max.	$\approx L$	Dimens.- Ident	SE-KEG nor STEEL
$\varnothing d_1$	P Gg/1" (tpi)	$\varnothing d_2$	x	h_1					
1/16	27	25	x	9	7,52	7,62	9,2	.5782	●
1/8	27	30	x	11	9,87	9,96	9,3	.5783	●
1/4	18	38	x	14	13,13	13,21	14,1	.5784	●
3/8	18	45	x	14	16,55	16,63	14,3	.5785	●
1/2	14	45	x	18	20,62	20,70	18,6	.5786	●
3/4	14	55	x	22	25,93	26,02	18,9	.5787	●
1"	11 1/2	65	x	25	32,47	32,56	23,5	.5788	●
1 1/4	11 1/2	75	x	26	41,20	41,29	24,1	.5789	
1 1/2	11 1/2	90	x	27	47,27	47,36	24,5	.5790	
2"	11 1/2	105	x	28	59,28	59,37	25,3	.5791	





R (BSPT)

DIN EN 10226-1, ISO 7-1

≈DIN EN 24230

STEEL
Steel materials

normal standard

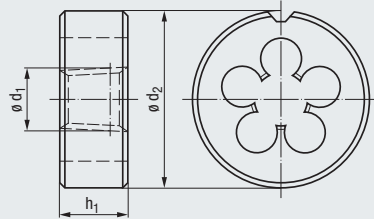
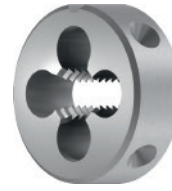

Bolzen-Vorarbeitsmaße im Kegel 1:16
Preparatory bolt dimensions on taper 1:16

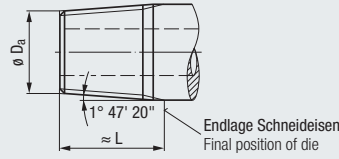

Technische Informationen
Technical information

» 499 - 506

Toleranz · Tolerance
Schneidstoff · Cutting material

HSS



1,5

O / P

Einsatzgebiete – Material
Applications – material

» 476

P 1.1-3.1

N 2.3

Werkzeug-Ident · Tool ident

D0191000

Nenngröße
Nom. size

Dimens.-
Ident

**SE-KEG
nor
STEEL**

R	$\varnothing d_1$	P Gg/1" (tpi)	$\varnothing d_2$	x	h_1	$\varnothing D_a$	Tol.	$\approx L$	Dimens.- Ident	SE-KEG nor STEEL
	1/8	28	30	x	11	9,48	± 0,05	8,1	.4069	●
	1/4	19	38	x	14	12,78	± 0,08	12	.4070	●
	3/8	19	45	x	14	16,26	± 0,08	12,4	.4071	●
	1/2	14	45	x	18	20,44	± 0,11	16,4	.4072	●
	3/4	14	55	x	22	25,85	± 0,11	17,7	.4073	●
	1"	11	65	x	25	32,60	± 0,14	20,8	.4074	●

Zugehöriges Innengewinde ist zylindrisch, siehe Gewindebohrer Seite 179 - 181
The appropriate internal thread is cylindrical, see taps, page 179 - 181

- Product Finder
- V_C
- M
- MF
- UNC
- UNF
UNEF
- G
- NPT, NPTF
R
- BSW, BSF
- Tr, Tr-F
- Zubehör
Accessories
- Tech. Info



Gewindefräser für kegelige Gewinde
Typ GF-KEG siehe Seite 399 - 412

Thread milling cutters for tapered threads
type GF-KEG, see page 399 - 412

- Product Finder
- V_c
- M
- MF
- UNC
- UNF
UNEF
- G
- NPT, NPTF
R
- BSW, BSF
- Tr, Tr-F
- Zubehör
Accessories
- Tech. Info

BSW



BS 84

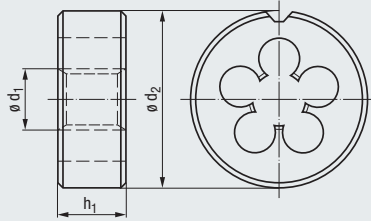

Vorarbeitdurchmesser $d \approx$
Preparatory diameter $d \approx$



DIN EN
22568

STEEL
Steel
materials

normal
standard



Toleranz · Tolerance

medium class

Schneidstoff · Cutting material

HSS

Technische Informationen
Technical information

» 499 - 506



1,5

E / O

Einsatzgebiete – Material
Applications – material

» 476

P 1.1-3.1

N 2.2, 4.2

Werkzeug-Ident · Tool ident

D0101000

	$\varnothing d_1$ inch	$\varnothing d_1$ mm	P Gg/1" (tpi)	$\varnothing d_2$	x	h_1	$\varnothing d \approx$ medium class	Dimens.- Ident	SE-B nor STEEL
BSW	1/16	1,59	60	16	x	5	1,51	.3044	●
	3/32	2,38	48	16	x	5	2,30	.3045	●
	1/8	3,18	40	20	x	5	3,09	.3046	●
	5/32	3,97	32	20	x	7	3,88	.3047	●
	3/16	4,76	24	20	x	7	4,66	.3048	●
	7/32	5,56	24	20	x	7	5,46	.3049	●
	1/4	6,35	20	20	x	7	6,24	.3050	●
	5/16	7,94	18	25	x	9	7,82	.3051	●
	3/8	9,53	16	30	x	11	9,40	.3052	●
	7/16	11,11	14	30	x	11	10,98	.3053	●
	1/2	12,70	12	38	x	14	12,56	.3054	●
	9/16	14,29	12	38	x	14	14,14	.3055	●
	5/8	15,88	11	45	x	18	15,72	.3056	●
	3/4	19,05	10	45	x	18	18,89	.3058	●
	7/8	22,23	9	55	x	22	22,10	.3060	●
	1"	25,40	8	55	x	22	25,27	.3062	●
	1 1/8	28,58	7	65	x	25	28,44	.3063	●
	1 1/4	31,75	7	65	x	25	31,61	.3064	●
	1 3/8	34,93	6	65	x	25	34,77	.3065	●
	1 1/2	38,10	6	75	x	30	37,95	.3066	●
	1 5/8	41,28	5	75	x	30	41,11	.3067	○
	1 3/4	44,45	5	90	x	36	44,28	.3068	●
	2"	50,80	4 1/2	90	x	36	50,62	.3070	●



BSF



BS 84

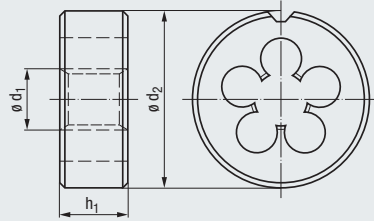

Vorarbeitdurchmesser $d \approx$
Preparatory diameter $d \approx$



DIN EN 22568

STEEL
Steel materials

normal standard

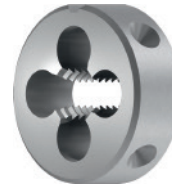

Technische Informationen
Technical information

» 499 - 506

Toleranz · Tolerance
Schneidstoff · Cutting material



Einsatzgebiete – Material
Applications – material

» 476

medium class

HSS

1,5

E / O

P 1.1-3.1

N 2.2, 4.2

Werkzeug-Ident · Tool ident

D0101000

	$\varnothing d_1$ inch	$\varnothing d_1$ mm	P Gg/1" (tpi)	$\varnothing d_2$	x	h_1	$\varnothing d \approx$ medium class	Dimens.- Ident	SE-B nor STEEL
BSF	3/16	4,76	32	20	x	7	4,67	.3088	●
	1/4	6,35	26	20	x	7	6,25	.3090	●
	5/16	7,94	22	25	x	9	7,83	.3092	●
	3/8	9,53	20	30	x	11	9,41	.3093	●
	7/16	11,11	18	30	x	11	10,99	.3094	●
	1/2	12,70	16	38	x	10	12,57	.3095	●
	5/8	15,88	14	45	x	14	15,73	.3097	●
	3/4	19,05	12	45	x	14	18,89	.3099	●
	7/8	22,23	11	55	x	16	22,11	.3101	●
	1"	25,40	10	55	x	16	25,28	.3102	●

- Product Finder
- V_c
- M
- MF
- UNC
- UNF
UNEF
- G
- NPT, NPTF
R
- BSW, BSF
- Tr, Tr-F
- Zubehör
Accessories
- Tech. Info



- Product Finder
- Vc
- M
- MF
- UNC
- UNF
UNEF
- G
- NPT, NPTF
R
- BSW, BSF
- Tr, Tr-F
- Zubehör
Accessories
- Tech. Info



DIN 103

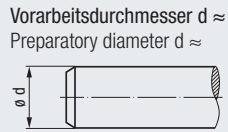
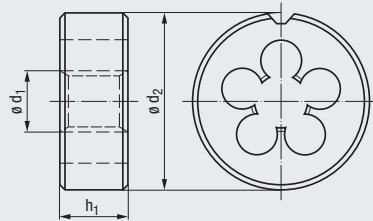

STEEL
Steel
materials

normal
standard

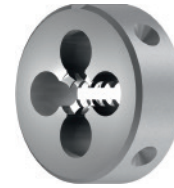

Toleranz · Tolerance
Schneidstoff · Cutting material

7e

HSS

Technische Informationen
Technical information ▶▶ 499 - 506



1,5-2

O / P

Einsatzgebiete – Material
Applications – material ▶▶ 476

P 1.1¹⁾

N 2.3¹⁾

Werkzeug-Ident · Tool ident

D0101000

Tr	$\varnothing d_1$ mm			P mm	$\varnothing d_2$ x h_1			$\varnothing d \approx$ „7e“	Dimens.- Ident	TRAPEZ SE-B nor STEEL
	x	x	x		x	x	x			
8	x	1,5	25	x	9	7,93	.7040	●		
10	x	2	38	x	14	9,91	.7043	●		
10	x	3	38	x	14	9,88	.7044	●		
11	x	3	38	x	14	10,88	.7045	●		
12	x	3	38	x	14	11,88	.7046	●		
14	x	3	45	x	18	13,88	.7047	●		
14	x	4	45	x	18	13,85	.7048	●		
16	x	4	45	x	18	15,85	.7051	●		
18	x	4	45	x	18	17,85	.7052	●		
20	x	4	55	x	22	19,85	.7053	●		
22	x	5	55	x	22	21,83	.7054	●		
24	x	5	65	x	25	23,83	.7055	●		
26	x	5	65	x	25	25,83	.7057	●		
28	x	5	65	x	25	27,83	.7058	●		
30	x	6	65	x	25	29,81	.7059	●		
32	x	6	65	x	25	31,81	.7060	●		

¹⁾ Nur zum Nachschneiden geeignet
Suitable only for reconditioning



Gewindebohrer für Trapez-Gewinde
siehe Seite 232 - 236

Taps for trapezoidal threads,
see page 232 - 236



DIN 103

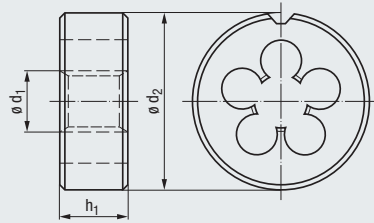

Vorarbeitdurchmesser $d \approx$
Preparatory diameter $d \approx$



STEEL
Steel materials

normal standard

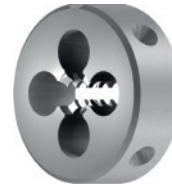

Technische Informationen
Technical information

» 499 - 506

Toleranz · Tolerance
Schneidstoff · Cutting material



Einsatzgebiete – Material
Applications – material

» 476

7e

HSS

1,5-2

0 / P

P 1.1¹⁾

N 2.3¹⁾

Werkzeug-Ident · Tool ident

D0101000

$\varnothing d_1$ mm	P mm	$\varnothing d_2$	x	h_1	$\varnothing d \approx$ „7e“	Dimens.- Ident	TRAPEZ SE-B nor STEEL
Tr 12	x 2	38	x 14		11,91	.7129	●
14	x 2	38	x 14		13,91	.7130	●
16	x 2	45	x 18		15,91	.7132	●
18	x 2	45	x 18		17,91	.7133	●
20	x 2	45	x 18		19,91	.7134	●
22	x 3	55	x 22		21,88	.7156	
24	x 3	55	x 22		23,88	.7157	
26	x 3	55	x 22		25,88	.7159	
28	x 3	65	x 25		27,88	.7160	
30	x 3	65	x 25		29,88	.7161	

¹⁾ Nur zum Nachschneiden geeignet
Suitable only for reconditioning

- Product Finder
- V_C
- M
- MF
- UNC
- UNF
UNEF
- G
- NPT, NPTF
R
- BSW, BSF
- Tr, Tr-F
- Zubehör
Accessories
- Tech. Info



- Product Finder
- Vc
- M
- MF
- UNC
- UNF
UNEF
- G
- NPT, NPTF
R
- BSW, BSF
- Tr, Tr-F
- Zubehör
Accessories
- Tech. Info

**DIN EN
22568**



Werkzeug-Ident · Tool ident **FZ201000**

Schneideisenhalter Nr. Die stock no.	Schneideisen-Aufnahme Die adaptation		Dimens.- Ident	
	$\varnothing d_2$	h_1		
1	16	x 5	.01	●
2	20	x 5	.02	●
3	20	x 7	.03	●
4	25	x 9	.04	●
5	30	x 11	.05	●
6	38	x 10	.06	●
7	38	x 14	.07	●
8	45	x 14	.08	●
9	45	x 18	.09	●
10	55	x 16	.10	●
11	55	x 22	.11	●
12	65	x 18	.12	●
13	65	x 25	.13	●
14	75	x 20	.14	●
15	75	x 30	.15	●
16	90	x 22	.16	●
17	90	x 36	.17	●
18	105	x 22	.18	●
19	105	x 36	.19	●

Exact-Führungen Precision guides

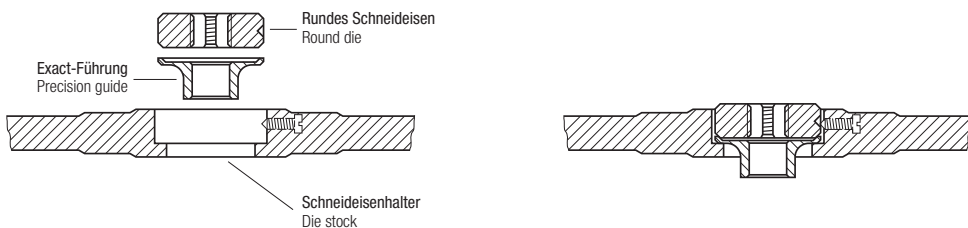

Exact-Führungen zum leichteren Anschneiden von Hand auf Anfrage
Precision guides for better performance when cutting by hand upon request

Technische Informationen

Technical information

Seite · Page

4.1	EMUGE Schneideisen-Bauformen The constructional designs of our EMUGE dies	500
4.2	EMUGE Geometriebezeichnungen Our EMUGE geometries	501
4.3	Sonstige EMUGE-Kurzbezeichnungen Other EMUGE abbreviations	501
4.4	Anschnittlängen Chamfer lengths	502
4.5	Kühl- und Schmierstoffe Cooling and lubrication agents	502
4.6	Toleranzfelder des Flankendurchmessers beim Metrischen Gewinde (schematische Darstellung) Tolerance zones of the pitch diameter on the Metric thread (graphic representation)	503
4.7	Toleranzfelder des Flankendurchmessers beim Unified-Gewinde (schematische Darstellung) Tolerance zones of the pitch diameter on the Unified thread (graphic representation)	504
4.8	Technischer Fragebogen: Schneideisen Technical questionnaire: Dies	505 - 506

Product
FinderV_c

M

MF

UNC

UNF
UNEF

G

NPT, NPTF
R

BSW, BSF

Tr, Tr-F

Zubehör
Accessories

Tech. Info



Die Technischen Informationen der jeweiligen Kapitel dieses Kataloges sind in vielen Landessprachen auch als separate Druckerzeugnisse verfügbar. Bitte wenden Sie sich an den für Sie zuständigen Vertriebspartner.

The technical information complementing the various chapters of this catalogue is available also as a separate printed booklet in many different languages. Please speak to your usual sales contact.

- Product Finder
- V_c
- M
- MF
- UNC
- UNF
UNEF
- G
- NPT, NPTF
R
- BSW, BSF
- Tr, Tr-F
- Zubehör
Accessories
- Tech. Info**

4.1 EMUGE Schneideisen-Bauformen

4.1 Constructional designs of our EMUGE dies

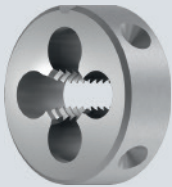
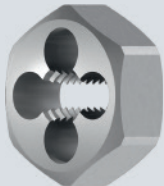

Bauformen nach DIN (Beispiele)

Constructional designs acc. DIN (examples)

	Bauform Constructional design	Baumaße Dimensions	EMUGE-Bezeichnung EMUGE designation
	Runde Schneideisen (B = vorgeschlitzt) Round dies (B = pre-slotted)	DIN EN 22568	SE-B
	Sechskant-Schneideisen Hexagon dies	DIN 382	SE-6KT

Bauformen nach EMUGE-Werknorm (Beispiele)

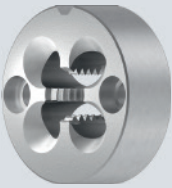
Constructional designs acc. EMUGE standard (examples)

	Bauform Constructional design	EMUGE-Bezeichnung EMUGE designation
	Automaten-Schneideisen mit Aufschraublöchern Dies for automatic lathes with fixing holes	SE-AUT-LD
	Glocken-Schneideisen Acorn dies	SE-GLOCK

4.2 EMUGE Geometriebezeichnungen

4.2 Our EMUGE geometries

STEEL**Für Stahlwerkstoffe**

Diese Schneideisen sind mit einem Schälanschnitt ausgeführt, um in langspanenden Materialien dem Span eine axiale Richtung zu geben.

For steel materials

These dies are made with a spiral point which, in long-chipping materials, guides the chip in an axial direction.

VA**Für nichtrostende Stahlwerkstoffe und Stahlwerkstoffe**

Ein etwas längerer Anschnitt ergibt eine bessere Spanaufteilung. Der Schälanschnitt führt das Spanmaterial in axialer Richtung ab, somit kann der Kühlschmierstoff ungehindert nachfließen.

For stainless steel materials and steel materials

The chamfer of these dies is a little longer, and provides an improved chip division. A spiral point ensures chip transport in an axial direction, so that the coolant-lubricant can flow freely.

MS**Für Kupfer-Zink-Legierungen (Messing, kurzspanend)**

Ohne Schälanschnitt für axiale Kraftneutrales Anschneiden sowie mit reduziertem Spanwinkel für einen stabilen Schneidkeil.

For copper-zinc alloys (brass, short-chipping)

Design without spiral point for a first cutting phase without any axial force, and with a reduced rake angle for a stable cutting wedge.

4.3 Sonstige EMUGE-Kurzbezeichnungen

4.3 Other EMUGE abbreviations

nor**Normal**

Ohne besondere Oberflächenbehandlung.

Normal

No special surface treatment.

gel**Geläppt**

Durch die geläppte Oberfläche im Gewinde wird Reibung herabgesetzt und somit ein besseres Schneidergebnis erzielt.

Lapped

The lapped thread surface reduces friction and helps to achieve an improved cutting performance.

Product
FinderV_c

M

MF

UNC

UNF
UNEF

G

NPT, NPTF
R

BSW, BSF

Tr, Tr-F

Zubehör
Accessories

Tech. Info



- Product Finder
- V_c
- M
- MF
- UNC
- UNF
UNEF
- G
- NPT, NPTF
R
- BSW, BSF
- Tr, Tr-F
- Zubehör
Accessories
- Tech. Info

4.4 Anschnittlängen

4.4 Chamfer lengths

Anschnittlängen für Schneideisen nach EMUGE-Werknorm.

Chamfer lengths for dies acc. EMUGE standard.

1

Anschnittlänge 1 Gang

Chamfer length 1 thread

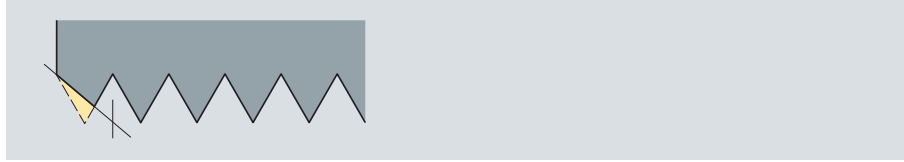

1,5

Anschnittlänge 1,5 Gänge

Chamfer length 1,5 threads

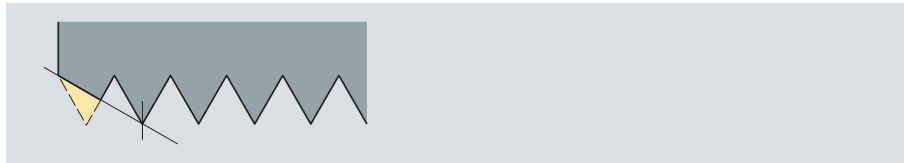

2

Anschnittlänge 2 Gänge

Chamfer length 2 threads

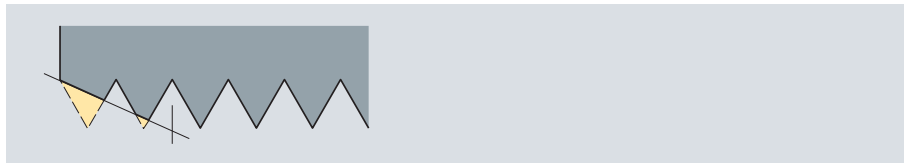

4.5 Kühl- und Schmierstoffe

4.5 Cooling and lubrication agents

Dem Schmiermittel wird im Allgemeinen zu wenig Bedeutung geschenkt. Um vom Werkzeug die volle Leistung zu erhalten, muss der richtige Kühlschmierstoff verwendet werden.

Lubricants are often, if not generally, given too little consideration. If you want to get the best performance out of your tool you have to take care to use the best coolant-lubricant available.

Grundsätzlich unterscheiden wir folgende Arten der Kühlung und Schmierung:

In general, we distinguish the following types of cooling and lubrication:

E

Emulsion

(EMUGE-Gewindeschneidöl Nr. 3+ EMULSION)

Die gebräuchlichste Kühlschmierung auf Bearbeitungszentren.

Emulsion

(EMUGE thread cutting oil no. 3+ EMULSION)

The most common type of coolant-lubricant on machining centres.

O

Gewindeschneidöl

(EMUGE-Gewindeschneidöle Nr. 1+ STEEL, Nr. 2+ CAST IRON, Nr. 4+ NON FERROUS, Nr. 5+ HIGH ALLOY)

Abgestimmt auf die zu bearbeitenden Werkstoffe werden hervorragende Gewindeoberflächen und Standwerte erreicht.

Thread cutting oil

(EMUGE thread cutting oils no.1+ STEEL, no. 2+ CAST IRON, no. 4+ NON FERROUS, no. 5+ HIGH ALLOY)

With these oils which are perfectly adjusted to specific materials, excellent thread surfaces and tool life can be achieved.

4.6 Toleranzfelder des Flankendurchmessers beim Metrischen Gewinde (schematische Darstellung)

4.6 Tolerance zones of the pitch diameter on the Metric thread (graphic representation)

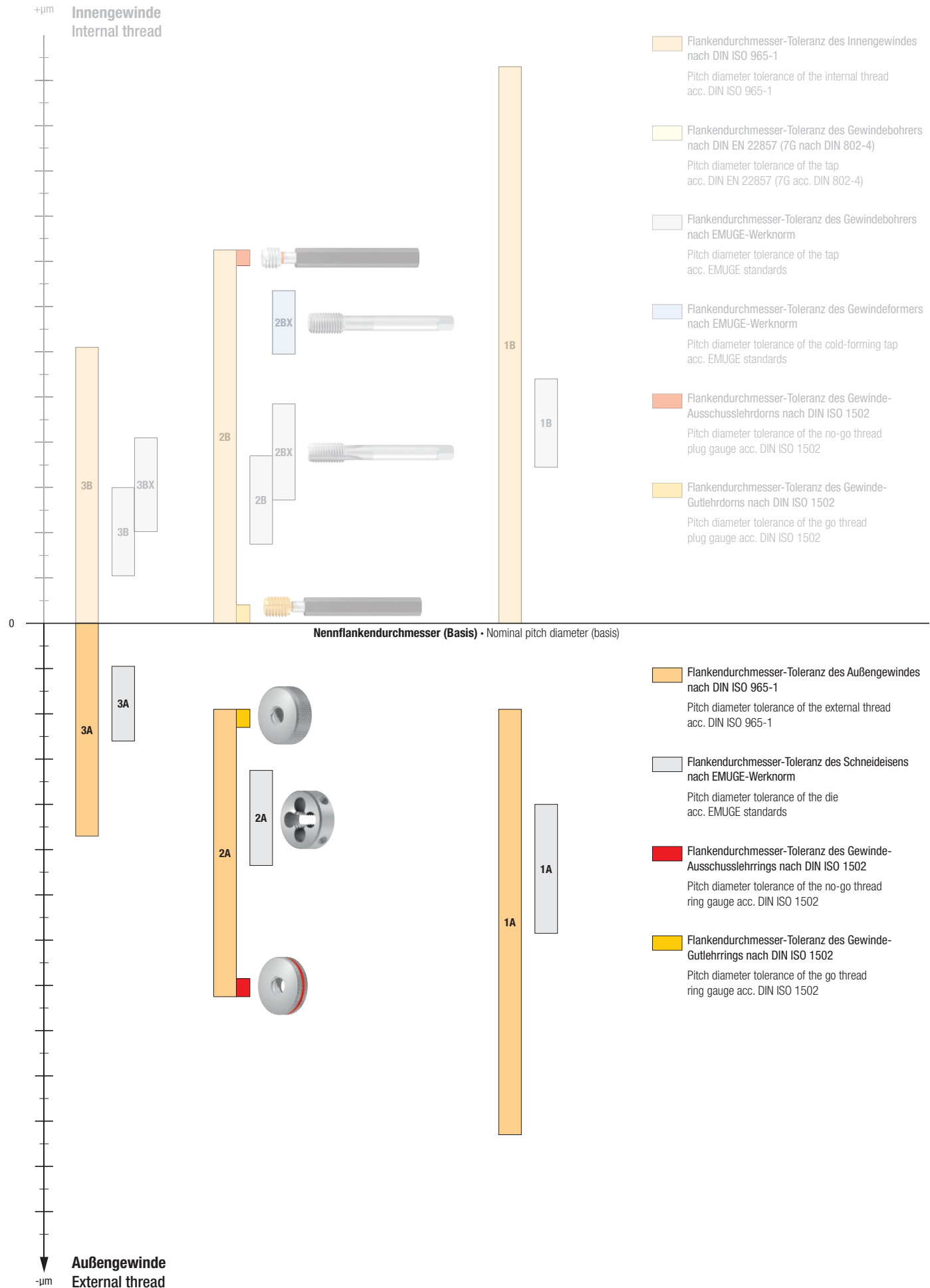

- Product Finder
- V_c
- M
- MF
- UNC
- UNF
UNEF
- G
- NPT, NPTF
R
- BSW, BSF
- Tr, Tr-F
- Zubehör
Accessories
- Tech. Info**



- Product Finder
- V_c
- M
- MF
- UNC
- UNF
UNEF
- G
- NPT, NPTF
R
- BSW, BSF
- Tr, Tr-F
- Zubehör
Accessories
- Tech. Info

4.7 Toleranzfelder des Flankendurchmessers beim Unified-Gewinde (schematische Darstellung)

4.7 Tolerance zones of the pitch diameter on the Unified thread (graphic representation)

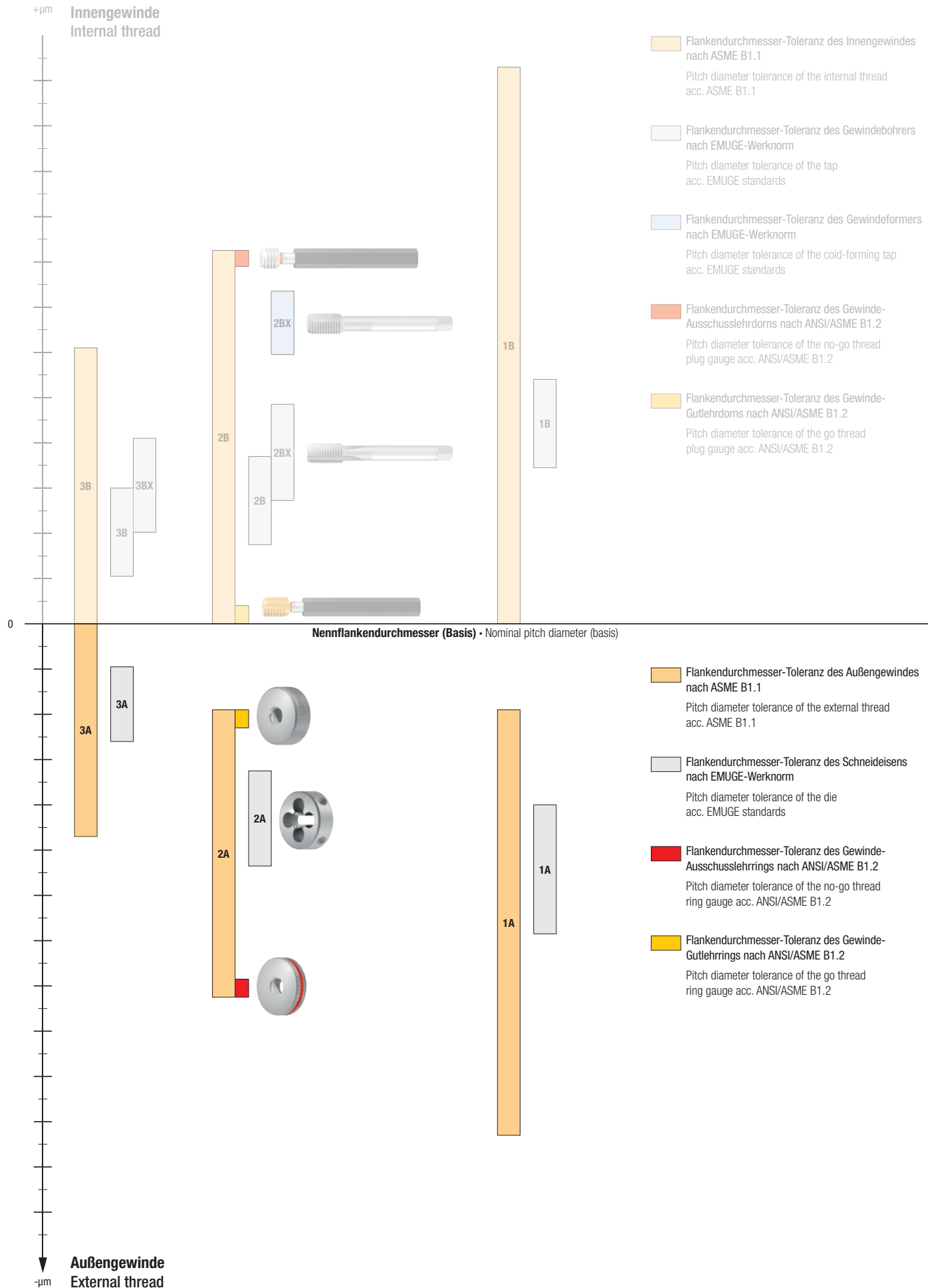

4.8 Technischer Fragebogen: Schneideisen

Firma:
 Ansprechpartner:
 Telefon:
 Fax:
 E-Mail:

Abmessung:
 Ausführung:
 Artikel-Nr.:
 Projekt:

Werkstückbezeichnung:

Bolzendurchmesser:
 gedreht gegossen gezogen

Bolzenform (bitte Maße eintragen):

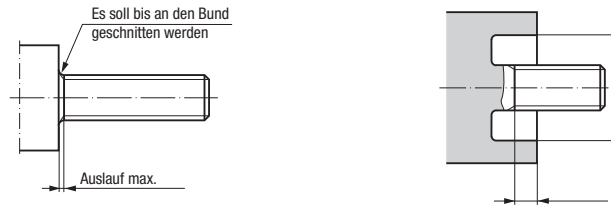

Maschine:

Hersteller:
 Typ:
 Antriebsleistung: kW
 horizontal Werkzeug rotierend
 vertikal Werkzeug stehend

Spindelaufnahme:

MK / SK / HSK / TR / andere:
 DIN / ANSI / JIS / andere:

Schnittdaten:

Drehzahl n: min⁻¹
 Schnittgeschwindigkeit v_c: m/min

Werkstückwerkstoff:

Bezeichnung:
 Behandlungszustand:
 Festigkeit: N/mm²
 Härte: Dehnung: %
 kurzspanend langspanend

Vorschub:

Andruckkurve Sonstige:
 Hydraulik
 Leitpatrone
 NC-gesteuert
 Synchronspindel
 Zahnräder

Kühlung:

Öl Emulsion % Trocken
 Umlauf Pinsel Nebel Sonstige:

Werkzeugaufnahme:

starr (Spannzange)
 Gewindeschneidapparat } Hersteller:
 Gewindeschneidfutter } Typ:
 mit Überlastkupplung
 mit Längenausgleich
 mit achsparalleler Pendelung
 mit innerer Kühlschmierstoff-Zufuhr Druck: bar

Werkzeug-Empfehlung:

Ausführung:
 Artikel-Nr.:
 d₂ x h₁: DIN:
 Besonderheit:
 Bisher verwendete Werkzeuge (Hersteller):
 Standwert: (Anzahl der Gewinde)

Aufgenommen von:

Datum / Unterschrift:

- Product Finder
- v_c
- M
- MF
- UNC
- UNF
- UNEF
- G
- NPT, NPTF
- R
- BSW, BSF
- Tr, Tr-F
- Zubehör
- Accessories
- Tech. Info



- Product Finder
- V_c
- M
- MF
- UNC
- UNF
UNEF
- G
- NPT, NPTF
R
- BSW, BSF
- Tr, Tr-F
- Zubehör
Accessories
- Tech. Info

4.8 Technical questionnaire: Dies

Company:
 Contact:
 Phone:
 Fax:
 E-mail:

Size:
 Design:
 Article no.:
 Project:

Workpiece description:

Bolt diameter:
 turned cast drawn

Bolt type (please enter dimensional specifications):

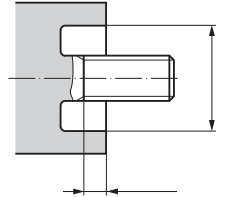
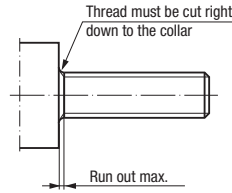
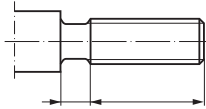
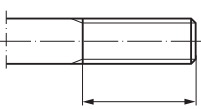

Machine:

Manufacturer:
 Type:
 Power: kW
 horizontal rotating tool
 vertical standing tool

Spindle adaptation:

MT / ISO taper / HSK / TR / others:
 DIN / ANSI / JIS / others:

Cutting data:

Speed n: rpm
 Cutting speed v_c: m/min

Workpiece material:

Description:
 Condition during work:
 Tensile strength: N/mm²
 Hardness: Elongation: %
 short-chipping long-chipping

Feed:

Pressure cam Others:
 Hydraulics
 Lead screw
 NC-controlled
 Synchronous spindle
 Gear wheels

Cooling/lubrication:

Oil Emulsion % Dry
 Circulation Brush Mist Others:

Tool holder:

Rigid (collet)
 Tapping attachment } Manufacturer:
 Tap holder } Type:
 with overload clutch
 with length compensation
 with axial parallel floating
 with internal coolant supply Pressure: bar

Tool recommendation:

Design:
 Article no.:
 d₂ x h₁: DIN:
 Special features:
 Tools used until now (manufacturer):
 Tool life: (no. of threads)

Filled in by:

Date/signature:



Spiralbohrer Twist Drills

Seite · Page

Übersicht	Contents	508 - 509
Wegweiser und Schnittwerte	Product finder and cutting data	510 - 521
Produktseiten	Product pages	522 - 566
Technische Informationen	Technical information	567 - 580



- Product Finder
- v_c / f
- STEEL
- VA
- GG
- HCUT
- Zubehör
Accessories
- Tech. Info



Seite · Page

STEEL	523	524 - 527	528 - 531	532 - 535
VA			546 - 549	550 - 553
GG				554 - 557
HCUT		558		

- 3 x D
- 5 x D
- 6 x D
- 8 x D
- 2-3,5 x D

Seite · Page

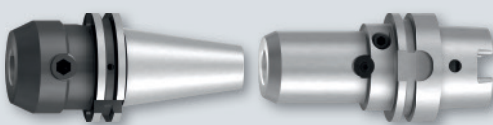
 <p>Kühlschmierstoffe Coolant-lubricants</p>	<p>238 - 239</p>
 <p>Werkzeug-Aufnahmen, Hydrodehnspannfutter und Zubehör Tool holders, hydraulic expansion chucks and accessories</p>	<p>562 - 566</p>



EF-Drill



8 x D

EF-Drill Modular



3 x D, 5 x D

Fasbohrer 90°
Chamfer drill 90°

EF-Drill
C



2 - 3,5 x D

Seite · Page

536 - 539

540 - 545

560

561

STEEL

VA

GG

HCUT

Product
Finder

v_c / f

STEEL

VA

GG

HCUT

Zubehör
Accessories

Tech. Info

3 x D

5 x D

6 x D

8 x D

2-3,5 x D



- Product Finder
- v_c / f
- STEEL
- VA
- GG
- HCUT
- Zubehör
Accessories
- Tech. Info

Wegweiser und Schnittwerte

Bitte beachten:

Die Eignung der Spiralbohrer ist in den jeweiligen Spalten folgendermaßen gekennzeichnet:

- = sehr gut geeignet
- = gut geeignet

Die zugehörigen Schnittgeschwindigkeiten v_c [m/min] und Vorschübe pro Umdrehung f [mm/U] sind auf den Seiten 514 - 521 zu finden.

Internationaler Werkstoffvergleich siehe Seite 838 - 851.

Product finder and cutting data

Please note:

The suitability of the twist drills is marked in the respective columns as follows:

- = very suitable
- = suitable

The appropriate cutting speeds v_c [m/min] and feed per revolution values f [mm/rev.] are to be found on pages 514 - 521.

International comparison of materials, see page 838 - 851.

		Einsatzgebiete – Material Applications – material		Material-Beispiele Material examples	Material-Nummern Material numbers	
P	Stahlwerkstoffe Steel materials					
	1.1	Kaltfließpressstähle, Baustähle, Automatenstähle, u.a.	Cold-extrusion steels, Construction steels, Free-cutting steels, etc.	≤ 600 N/mm ²	Cq15 S235JR (St37-2) 10SPb20 1.0722	1.1132 1.0037 1.0722
	2.1	Baustähle, Einsatzstähle, Stahlguss, u.a.	Construction steels, Cementation steels, Steel castings, etc.	≤ 800 N/mm ²	E360 (St70-2) 16MnCr5 GS-25CrMo4	1.0070 1.7131 1.7218
	3.1	Einsatzstähle, Vergütungsstähle, Kaltarbeitsstähle, u.a.	Cementation steels, Heat-treatable steels, Cold work steels, etc.	≤ 1000 N/mm ²	20MoCr3 42CrMo4 102Cr6	1.7320 1.7225 1.2067
	4.1	Vergütungsstähle, Kaltarbeitsstähle, Nitrierstähle, u.a.	Heat-treatable steels, Cold work steels, Nitriding steels, etc.	≤ 1200 N/mm ²	50CrMo4 X45NiCrMo4 31CrMo12	1.7228 1.2767 1.8515
	5.1	Hochlegierte Stähle, Kaltarbeitsstähle, Warmarbeitsstähle, u.a.	High-alloyed steels, Cold work steels, Hot work steels, etc.	≤ 1400 N/mm ²	X38CrMoV5-3 X100CrMoV8-1-1 X40CrMoV5-1	1.2367 1.2990 1.2344
M	Nichtrostende Stahlwerkstoffe Stainless steel materials					
	1.1	Ferritisch, martensitisch	Ferritic, martensitic	≤ 950 N/mm ²	X2CrTi12	1.4512
	2.1	Austenitisch	Austenitic	≤ 950 N/mm ²	X6CrNiMoTi17-12-2	1.4571
	3.1	Austenitisch-ferritisch (Duplex)	Austenitic-ferritic (Duplex)	≤ 1100 N/mm ²	X2CrNiMoN22-5-3	1.4462
	4.1	Austenitisch-ferritisch hitzebeständig (Super Duplex)	Austenitic-ferritic heat-resistant (Super Duplex)	≤ 1250 N/mm ²	X2CrNiMoN25-7-4	1.4410
K	Gusswerkstoffe Cast materials					
	1.1	Gusseisen mit Lamellengrafit (GJL)	Cast iron with lamellar graphite (GJL)	100-250 N/mm ²	EN-GJL-200 (GG20)	EN-JL-1030
	1.2	Gusseisen mit Kugelgrafit (GJS)	Cast iron with nodular graphite (GJS)	250-450 N/mm ²	EN-GJL-300 (GG30)	EN-JL-1050
	2.1	Gusseisen mit Kugelgrafit (GJS)	Cast iron with nodular graphite (GJS)	350-500 N/mm ²	EN-GJS-400-15 (GGG40)	EN-JS-1030
	2.2	Gusseisen mit Kugelgrafit (GJS)	Cast iron with nodular graphite (GJS)	500-900 N/mm ²	EN-GJS-700-2 (GGG70)	EN-JS-1070
	3.1	Gusseisen mit Vermiculargrafit (GJV)	Cast iron with vermicular graphite (GJV)	300-400 N/mm ²	GJV 300	
	3.2	Gusseisen mit Vermiculargrafit (GJV)	Cast iron with vermicular graphite (GJV)	400-500 N/mm ²	GJV 450	
4.1	Temperguss (GTMW, GTMB)	Malleable cast iron (GTMW, GTMB)	250-500 N/mm ²	EN-GJMW-350-4 (GTW-35)	EN-JM-1010	
4.2	Temperguss (GTMW, GTMB)	Malleable cast iron (GTMW, GTMB)	500-800 N/mm ²	EN-GJMB-450-6 (GTS-45)	EN-JM-1140	
N	Nichteisenwerkstoffe Non ferrous materials					
	Aluminium-Legierungen Aluminium alloys					
	1.1	Aluminium-Knetlegierungen	Aluminium wrought alloys	≤ 200 N/mm ²	EN AW-AlMn1	EN AW-3103
	1.2	Aluminium-Knetlegierungen	Aluminium wrought alloys	≤ 350 N/mm ²	EN AW-AlMgSi	EN AW-6060
	1.3	Aluminium-Knetlegierungen	Aluminium wrought alloys	≤ 550 N/mm ²	EN AW-AlZn5Mg3Cu	EN AW-7022
	1.4	Aluminium-Knetlegierungen	Aluminium wrought alloys	Si ≤ 7%	EN AC-AlMg5	EN AC-307 G
	1.5	Aluminium-Gusslegierungen	Aluminium cast alloys	7% < Si ≤ 12%	EN AC-AISi9Cu3	EN AC-46500
	1.6	Aluminium-Gusslegierungen	Aluminium cast alloys	12% < Si ≤ 17%	GD-AISi17Cu4FeMg	
	Kupfer-Legierungen Copper alloys					
	2.1	Reinkupfer, niedriglegiertes Kupfer	Pure copper, low-alloyed copper	≤ 400 N/mm ²	E-Cu 57	EN CW 004 A
	2.2	Kupfer-Zink-Legierungen (Messing, langspanend)	Copper-zinc alloys (brass, long-chipping)	≤ 550 N/mm ²	CuZn37 (Ms63)	EN CW 508 L
	2.3	Kupfer-Zink-Legierungen (Messing, kurzspanend)	Copper-zinc alloys (brass, short-chipping)	≤ 550 N/mm ²	CuZn36Pb3 (Ms58)	EN CW 603 N
	2.4	Kupfer-Aluminium-Legierungen (Alubronze, langspanend)	Copper-aluminium alloys (alu bronze, long-chipping)	≤ 800 N/mm ²	CuAl10Ni5Fe4	EN CW 307 G
	2.5	Kupfer-Zinn-Legierungen (Zinnbronze, langspanend)	Copper-tin alloys (tin bronze, long-chipping)	≤ 700 N/mm ²	CuSn8P	EN CW 459 K
	2.6	Kupfer-Zinn-Legierungen (Zinnbronze, kurzspanend)	Copper-tin alloys (tin bronze, short-chipping)	≤ 400 N/mm ²	CuSn7 ZnPb (Rg7)	2.1090
	2.7	Kupfer-Sonderlegierungen	Special copper alloys	≤ 600 N/mm ²	(AMPCO® 8)	
2.8	Kupfer-Sonderlegierungen	Special copper alloys	≤ 1400 N/mm ²	(AMPCO® 45)		
Magnesium-Legierungen Magnesium alloys						
3.1	Magnesium-Knetlegierungen	Magnesium wrought alloys	≤ 500 N/mm ²	MgAl6Zn	3.5612	
3.2	Magnesium-Gusslegierungen	Magnesium cast alloys	≤ 500 N/mm ²	EN-MCMgAl9Zn1	EN-MC21120	
Kunststoffe Synthetics						
4.1	Duroplaste (kurzspanend)	Duroplastics (short-chipping)		Bakelit, Pertinax		
4.2	Thermoplaste (langspanend)	Thermoplastics (long-chipping)		PMMA, POM, PVC		
4.3	Faserverstärkte Kunststoffe (Faseranteil ≤ 30%)	Fibre-reinforced synthetics (fibre content ≤ 30%)		GFK, CFK, AFK		
4.4	Faserverstärkte Kunststoffe (Faseranteil > 30%)	Fibre-reinforced synthetics (fibre content > 30%)		GFK, CFK, AFK		
Besondere Werkstoffe Special materials						
5.1	Grafit	Graphite		C 8000		
5.2	Wolfram-Kupfer-Legierungen	Tungsten-copper alloys		W-Cu 80/20		
5.3	Verbundwerkstoffe	Composite materials		Hyllite, Alucobond		
S	Spezialwerkstoffe Special materials					
	Titan-Legierungen Titanium alloys					
	1.1	Reintitan	Pure titanium	≤ 450 N/mm ²	Ti1	3.7025
	1.2	Titan-Legierungen	Titanium alloys	≤ 900 N/mm ²	TiAl6V4	3.7165
	1.3	Titan-Legierungen	Titanium alloys	≤ 1250 N/mm ²	TiAl4Mo4Sn2	3.7185
	Nickel-, Kobalt- und Eisen-Legierungen Nickel alloys, cobalt alloys and iron alloys					
	2.1	Reinnickel	Pure nickel	≤ 600 N/mm ²	Ni 99.6	2.4060
	2.2	Nickel-Basis-Legierungen	Nickel-base alloys	≤ 1000 N/mm ²	Monel 400	2.4360
	2.3	Nickel-Basis-Legierungen	Nickel-base alloys	≤ 1600 N/mm ²	Inconel 718	2.4668
	2.4	Nickel-Basis-Legierungen	Nickel-base alloys	≤ 1000 N/mm ²	Udimet 605	
2.5	Kobalt-Basis-Legierungen	Cobalt-base alloys	≤ 1600 N/mm ²	Haynes 25	2.4964	
2.6	Eisen-Basis-Legierungen	Iron-base alloys	≤ 1500 N/mm ²	Incoloy 800	1.4958	
H	Harte Werkstoffe Hard materials					
	1.1	Hochfeste Stähle, gehärtete Stähle, Hartguss	High strength steels, hardened steels, hard castings	44 - 50 HRC	Weldox 1100	
	1.2	Hochfeste Stähle, gehärtete Stähle, Hartguss	High strength steels, hardened steels, hard castings	50 - 55 HRC	Hardox 550	
	1.3	Hochfeste Stähle, gehärtete Stähle, Hartguss	High strength steels, hardened steels, hard castings	55 - 60 HRC	Armax 600T	
	1.4	Hochfeste Stähle, gehärtete Stähle, Hartguss	High strength steels, hardened steels, hard castings	60 - 63 HRC	Ferro-Titanit	
	1.5	Hochfeste Stähle, gehärtete Stähle, Hartguss	High strength steels, hardened steels, hard castings	63 - 66 HRC	HSSE	

Kühlschmierstoff-Empfehlung
 Coolant-lubricant recommendation



Emulsion Emulsion	ö1 OI	Minimale Mengenschmierung (MMS) Minimum quantity lubrication (MQL)	Trocken / Druckluft Dry / Pressurised air	EF-Drill Micro STEEL		EF-Drill STEEL			Typ Type
				6 x D	3 x D	3 x D	5 x D	8 x D	Bohrtiefe Drill depth
				523	524 - 527	528 - 531	532 - 535	536 - 539	Seite Page
<input checked="" type="checkbox"/>	<input checked="" type="checkbox"/>	<input type="checkbox"/>		<input checked="" type="checkbox"/>	<input checked="" type="checkbox"/>	<input checked="" type="checkbox"/>	<input checked="" type="checkbox"/>	<input checked="" type="checkbox"/>	1.1
<input checked="" type="checkbox"/>	<input checked="" type="checkbox"/>	<input type="checkbox"/>		<input checked="" type="checkbox"/>	<input type="checkbox"/>	<input checked="" type="checkbox"/>	<input checked="" type="checkbox"/>	<input checked="" type="checkbox"/>	2.1
<input checked="" type="checkbox"/>	<input checked="" type="checkbox"/>	<input type="checkbox"/>		<input checked="" type="checkbox"/>	<input type="checkbox"/>	<input checked="" type="checkbox"/>	<input checked="" type="checkbox"/>	<input checked="" type="checkbox"/>	3.1
<input checked="" type="checkbox"/>	<input checked="" type="checkbox"/>	<input type="checkbox"/>		<input checked="" type="checkbox"/>	<input type="checkbox"/>	<input checked="" type="checkbox"/>	<input checked="" type="checkbox"/>	<input checked="" type="checkbox"/>	4.1
<input checked="" type="checkbox"/>	<input checked="" type="checkbox"/>	<input type="checkbox"/>		<input checked="" type="checkbox"/>	<input type="checkbox"/>	<input checked="" type="checkbox"/>	<input checked="" type="checkbox"/>	<input checked="" type="checkbox"/>	5.1
<input checked="" type="checkbox"/>	<input type="checkbox"/>			<input checked="" type="checkbox"/>		<input checked="" type="checkbox"/>	<input checked="" type="checkbox"/>	<input checked="" type="checkbox"/>	1.1
<input checked="" type="checkbox"/>	<input type="checkbox"/>			<input type="checkbox"/>		<input type="checkbox"/>	<input type="checkbox"/>	<input type="checkbox"/>	2.1
<input checked="" type="checkbox"/>	<input type="checkbox"/>			<input type="checkbox"/>		<input type="checkbox"/>	<input type="checkbox"/>	<input type="checkbox"/>	3.1
<input checked="" type="checkbox"/>	<input type="checkbox"/>			<input type="checkbox"/>		<input type="checkbox"/>	<input type="checkbox"/>	<input type="checkbox"/>	4.1
<input checked="" type="checkbox"/>		<input type="checkbox"/>	<input type="checkbox"/>	<input type="checkbox"/>	<input type="checkbox"/>	<input type="checkbox"/>	<input type="checkbox"/>	<input type="checkbox"/>	1.1
<input checked="" type="checkbox"/>		<input type="checkbox"/>	<input type="checkbox"/>	<input type="checkbox"/>	<input type="checkbox"/>	<input type="checkbox"/>	<input type="checkbox"/>	<input type="checkbox"/>	1.2
<input checked="" type="checkbox"/>		<input type="checkbox"/>	<input type="checkbox"/>	<input type="checkbox"/>	<input type="checkbox"/>	<input type="checkbox"/>	<input type="checkbox"/>	<input type="checkbox"/>	2.1
<input checked="" type="checkbox"/>		<input type="checkbox"/>	<input type="checkbox"/>	<input type="checkbox"/>	<input type="checkbox"/>	<input checked="" type="checkbox"/>	<input checked="" type="checkbox"/>	<input checked="" type="checkbox"/>	2.2
<input checked="" type="checkbox"/>		<input type="checkbox"/>	<input type="checkbox"/>	<input type="checkbox"/>	<input type="checkbox"/>	<input type="checkbox"/>	<input type="checkbox"/>	<input type="checkbox"/>	3.1
<input checked="" type="checkbox"/>		<input type="checkbox"/>	<input type="checkbox"/>	<input type="checkbox"/>	<input type="checkbox"/>	<input type="checkbox"/>	<input type="checkbox"/>	<input type="checkbox"/>	3.2
<input checked="" type="checkbox"/>		<input type="checkbox"/>	<input type="checkbox"/>	<input type="checkbox"/>	<input type="checkbox"/>	<input type="checkbox"/>	<input type="checkbox"/>	<input type="checkbox"/>	4.1
<input checked="" type="checkbox"/>		<input type="checkbox"/>	<input type="checkbox"/>	<input type="checkbox"/>	<input type="checkbox"/>	<input type="checkbox"/>	<input type="checkbox"/>	<input type="checkbox"/>	4.2
<input checked="" type="checkbox"/>	<input type="checkbox"/>			<input type="checkbox"/>	<input type="checkbox"/>	<input type="checkbox"/>	<input type="checkbox"/>	<input type="checkbox"/>	1.1
<input checked="" type="checkbox"/>	<input type="checkbox"/>			<input checked="" type="checkbox"/>	<input type="checkbox"/>	<input type="checkbox"/>	<input type="checkbox"/>	<input type="checkbox"/>	1.2
<input checked="" type="checkbox"/>	<input type="checkbox"/>			<input type="checkbox"/>	<input type="checkbox"/>	<input type="checkbox"/>	<input type="checkbox"/>	<input type="checkbox"/>	1.3
<input checked="" type="checkbox"/>	<input type="checkbox"/>			<input type="checkbox"/>	<input type="checkbox"/>	<input type="checkbox"/>	<input type="checkbox"/>	<input type="checkbox"/>	1.4
<input checked="" type="checkbox"/>	<input type="checkbox"/>			<input type="checkbox"/>	<input type="checkbox"/>	<input type="checkbox"/>	<input type="checkbox"/>	<input type="checkbox"/>	1.5
<input checked="" type="checkbox"/>	<input type="checkbox"/>			<input type="checkbox"/>	<input type="checkbox"/>	<input type="checkbox"/>	<input type="checkbox"/>	<input type="checkbox"/>	1.6
<input checked="" type="checkbox"/>	<input type="checkbox"/>			<input checked="" type="checkbox"/>	<input type="checkbox"/>	<input checked="" type="checkbox"/>	<input checked="" type="checkbox"/>	<input checked="" type="checkbox"/>	2.1
<input checked="" type="checkbox"/>	<input type="checkbox"/>			<input checked="" type="checkbox"/>	<input type="checkbox"/>	<input checked="" type="checkbox"/>	<input checked="" type="checkbox"/>	<input checked="" type="checkbox"/>	2.2
<input checked="" type="checkbox"/>	<input type="checkbox"/>			<input type="checkbox"/>	<input type="checkbox"/>	<input checked="" type="checkbox"/>	<input checked="" type="checkbox"/>	<input checked="" type="checkbox"/>	2.3
<input checked="" type="checkbox"/>	<input type="checkbox"/>			<input type="checkbox"/>	<input type="checkbox"/>	<input checked="" type="checkbox"/>	<input checked="" type="checkbox"/>	<input checked="" type="checkbox"/>	2.4
<input checked="" type="checkbox"/>	<input type="checkbox"/>			<input type="checkbox"/>	<input type="checkbox"/>	<input checked="" type="checkbox"/>	<input checked="" type="checkbox"/>	<input checked="" type="checkbox"/>	2.5
<input checked="" type="checkbox"/>	<input type="checkbox"/>			<input type="checkbox"/>	<input type="checkbox"/>	<input checked="" type="checkbox"/>	<input checked="" type="checkbox"/>	<input checked="" type="checkbox"/>	2.6
<input checked="" type="checkbox"/>	<input type="checkbox"/>			<input type="checkbox"/>	<input type="checkbox"/>	<input checked="" type="checkbox"/>	<input checked="" type="checkbox"/>	<input checked="" type="checkbox"/>	2.7
<input checked="" type="checkbox"/>	<input type="checkbox"/>			<input type="checkbox"/>	<input type="checkbox"/>	<input checked="" type="checkbox"/>	<input checked="" type="checkbox"/>	<input checked="" type="checkbox"/>	2.8
									3.1
									3.2
									4.1
									4.2
									4.3
									4.4
			<input checked="" type="checkbox"/>		<input type="checkbox"/>				5.1
									5.2
									5.3
<input checked="" type="checkbox"/>	<input type="checkbox"/>			<input type="checkbox"/>					1.1
<input checked="" type="checkbox"/>	<input type="checkbox"/>			<input type="checkbox"/>					1.2
<input checked="" type="checkbox"/>	<input type="checkbox"/>			<input type="checkbox"/>					1.3
									2.1
									2.2
									2.3
									2.4
									2.5
									2.6
<input checked="" type="checkbox"/>	<input checked="" type="checkbox"/>	<input type="checkbox"/>	<input type="checkbox"/>		<input type="checkbox"/>	<input checked="" type="checkbox"/>	<input checked="" type="checkbox"/>	<input checked="" type="checkbox"/>	1.1
<input checked="" type="checkbox"/>	<input checked="" type="checkbox"/>	<input type="checkbox"/>	<input type="checkbox"/>		<input type="checkbox"/>	<input type="checkbox"/>	<input type="checkbox"/>	<input type="checkbox"/>	1.2
									1.3
									1.4
									1.5

3 x D
 5 x D
 6 x D
 8 x D
 2-3,5 x D



Kühlschmierstoff-Empfehlung
 Coolant-lubricant recommendation



Emulsion Emulsion	Öl Oil	Minimale Mengenschmierung (MMS) Minimum quantity lubrication (MQL)	Trocken / Druckluft Dry / Pressurised air
----------------------	-----------	---	--

EF-Drill Modular STEEL		EF-Drill VA		EF-Drill GG
3 x D	5 x D	3 x D	5 x D	5 x D
540 - 544	540 - 543, 545	546 - 549	550 - 553	554 - 557

- 3 x D
- 5 x D
- 6 x D
- 8 x D
- 2-3,5 x D

Material	Coolant/Lubricant				Drill Bit				
	Emulsion	Oil	MMS	Dry/Air	3x D	5x D	3x D	5x D	5x D
P	1.1	■	■	□	■	■			
	2.1	■	■	□	■	■			
	3.1	■	■	□	■	■			
	4.1	■	■	□	■	■			
	5.1	■	■	□	■	■			
M	1.1	■	□		■	■	■	■	
	2.1	■	□				■	■	
	3.1	■	□				■	■	
	4.1	■	□				■	■	
K	1.1	■	□	□	■	■			■
	1.2	■	□	□	■	■			■
	2.1	■	□	□	■	■			■
	2.2	■	□	□	■	■			□
	3.1	■	□	□	□	□			■
	3.2	■	□	□	□	□			■
	4.1	■	□	□	□	□			■
	4.2	■	□	□	□	□			■
N	1.1	■	□				□	□	
	1.2	■	□				□	□	
	1.3	■	□				□	□	
	1.4	■	□		□	□			
	1.5	■	□		□	□			
	1.6								
	2.1	■	□						
	2.2	■	□						
	2.3	■	□						
	2.4	■	□						
	2.5	■	□						
	2.6	■	□						
	2.7	■	□						
	2.8	■	□						
	3.1								
	3.2								
4.1									
4.2									
4.3									
4.4									
5.1									
5.2									
5.3									
S	1.1	■	□				□	□	
	1.2	■	□				□	□	
	1.3	■	□				□	□	
	2.1								
	2.2	■	□				□	□	
	2.3								
2.4	■	□				□	□		
2.5									
2.6	■	□				□	□		
H	1.1	■	■	□	□				
	1.2	■	■	□	□				
	1.3	■	■	□	□				
	1.4	■	■	□	□				
	1.5	■	■	□	□				





EF-Drill HCUT	EF-Drill C STEEL	EF-Drill C VA	Typ Type
3 x D	2-3,5 x D	2-3,5 x D	Bohrtiefe Drill depth
558	560	561	Seite Page

			1.1	P
	■		2.1	
	■		3.1	
	■		4.1	
	■		5.1	
			1.1	M
		■	2.1	
		■	3.1	
		■	4.1	
			1.1	K
	□		1.2	
	□		2.1	
	■		2.2	
	□		3.1	
	□		3.2	
	□		4.1	
	□		4.2	
			1.1	N
	□	□	1.2	
	□	□	1.3	
	□		1.4	
	□		1.5	
	□		1.6	
			2.1	
	■		2.2	
	■		2.3	
	■		2.4	
	■		2.5	
	■		2.6	
	■		2.7	
	■		2.8	
			3.1	
			3.2	
			4.1	
			4.2	
			4.3	
			4.4	
			5.1	
			5.2	
			5.3	
			1.1	S
		□	1.2	
		□	1.3	
			2.1	
		□	2.2	
		□	2.3	
			2.4	
			2.5	
			2.6	
			1.1	H
□	■		1.2	
■	□		1.3	
■			1.4	
■			1.5	

3 x D
 5 x D
 6 x D
 8 x D
 2-3,5 x D





EF-Drill Micro
STEEL

	Schnittgeschwindigkeit v _c [m/min] Cutting speed v _c [m/min]			D = 0,8 mm			D = 1,0 mm			D = 1,25 mm			
	min.	empf. rec.	max.	Vorschub pro Umdrehung f [mm/U] - Feed per revolution f [mm/rev.]									
				min.	empf. rec.	max.	min.	empf. rec.	max.	min.	empf. rec.	max.	
P	1.1	80	90	100	0,020	0,025	0,030	0,030	0,035	0,040	0,040	0,045	0,050
	2.1	70	85	100	0,020	0,025	0,030	0,030	0,035	0,040	0,040	0,045	0,050
	3.1	60	65	70	0,010	0,015	0,020	0,020	0,025	0,030	0,030	0,035	0,040
	4.1	50	55	60	0,010	0,015	0,020	0,020	0,025	0,030	0,030	0,035	0,040
	5.1	45	50	55	0,010	0,015	0,020	0,020	0,025	0,030	0,030	0,035	0,040
M	1.1	40	48	55	0,005	0,008	0,010	0,010	0,013	0,015	0,020	0,023	0,025
	2.1	30	35	40	0,010	0,015	0,020	0,015	0,020	0,025	0,025	0,030	0,035
	3.1	30	35	40	0,005	0,008	0,010	0,010	0,013	0,015	0,020	0,023	0,025
	4.1	30	35	40	0,005	0,008	0,010	0,010	0,013	0,015	0,020	0,023	0,025
K	1.1	120	145	170	0,020	0,025	0,030	0,040	0,050	0,060	0,060	0,070	0,080
	1.2	120	145	170	0,020	0,025	0,030	0,040	0,050	0,060	0,060	0,070	0,080
	2.1	120	135	150	0,020	0,025	0,030	0,040	0,050	0,060	0,060	0,070	0,080
	2.2	90	105	120	0,010	0,015	0,020	0,030	0,040	0,050	0,050	0,060	0,070
	3.1	60	70	80	0,020	0,025	0,030	0,030	0,040	0,050	0,040	0,050	0,060
	3.2	60	70	80	0,010	0,015	0,020	0,020	0,030	0,040	0,030	0,040	0,050
	4.1	60	70	80	0,020	0,025	0,030	0,030	0,040	0,050	0,040	0,050	0,060
	4.2	60	70	80	0,010	0,015	0,020	0,020	0,030	0,040	0,030	0,040	0,050
N	1.1	100	140	180	0,030	0,035	0,040	0,040	0,045	0,050	0,050	0,055	0,060
	1.2	100	140	180	0,030	0,035	0,040	0,040	0,045	0,050	0,050	0,055	0,060
	1.3	100	140	180	0,030	0,035	0,040	0,040	0,045	0,050	0,050	0,055	0,060
	1.4	80	115	150	0,030	0,035	0,040	0,040	0,045	0,050	0,050	0,055	0,060
	1.5	80	115	150	0,020	0,025	0,030	0,030	0,035	0,040	0,040	0,045	0,050
	1.6	80	115	150	0,020	0,025	0,030	0,030	0,035	0,040	0,040	0,045	0,050
	2.1												
	2.2	120	135	150	0,010	0,020	0,030	0,020	0,030	0,040	0,030	0,040	0,050
	2.3	120	135	150	0,010	0,020	0,030	0,020	0,030	0,040	0,030	0,040	0,050
	2.4												
	2.5												
	2.6												
	2.7												
	2.8												
	3.1												
	3.2												
4.1													
4.2													
4.3													
4.4													
5.1													
5.2													
5.3													
S	1.1												
	1.2	20	25	30	0,010	0,015	0,020	0,010	0,015	0,020	0,025	0,030	0,035
	1.3	15	20	25	0,010	0,015	0,020	0,010	0,015	0,020	0,025	0,030	0,035
	2.1												
	2.2												
	2.6												
H	1.1												
	1.2												
	1.3												
	1.4												
	1.5												



Schnittwerte

Bei diesen Angaben handelt es sich um Richtwerte.

- Die fett gedruckten Richtwerte (**empf.**) sind bei stabilen Verhältnissen für leistungsfähige Werkzeugmaschinen mit ausreichend hohem Drehzahlniveau zu empfehlen.
- Entsprechend gelten die niedrigeren Schnittgeschwindigkeiten (**min.**) in Verbindung mit höheren Vorschubwerten (bis **max.**) für Werkzeugmaschinen mit niedrigeren Spindeldrehzahlen.
- Für optimale Werkstückverhältnisse und sehr leistungsfähige, hochdrehende Werkzeugmaschinen können die hohen Schnittgeschwindigkeiten (**max.**) bei ggf. reduzierten Vorschüben die beste Wahl sein.

Cutting data

Please note that these data are standard values only.

- We recommend the standard values in bold print (**rec.**) for stable work conditions and for high-performance machine tools with sufficient speed capability.
- Correspondingly, the lower cutting speeds (**min.**) in connection with higher feed values (up to **max.**) should be used for machine tools with lower spindle speeds.
- For optimum workpiece conditions, and for machine tools with extremely high performance and high spindle speeds, the high cutting speeds (**max.**) in connection with possibly reduced feed values can be applied.

D = 1,5 mm			D = 2,0 mm			D = 2,5 mm			D = 3,0 mm			
Vorschub pro Umdrehung f [mm/U] · Feed per revolution f [mm/rev.]												
min.	empf. rec.	max.	min.	empf. rec.	max.	min.	empf. rec.	max.	min.	empf. rec.	max.	
0,060	0,065	0,070	0,090	0,100	0,110	0,120	0,130	0,140	0,150	0,160	0,170	1.1
0,060	0,065	0,070	0,090	0,100	0,110	0,120	0,130	0,140	0,150	0,160	0,170	2.1
0,040	0,045	0,050	0,060	0,065	0,070	0,080	0,085	0,090	0,120	0,125	0,130	3.1
0,040	0,045	0,050	0,060	0,065	0,070	0,080	0,085	0,090	0,120	0,125	0,130	4.1
0,040	0,045	0,050	0,060	0,065	0,070	0,080	0,085	0,090	0,120	0,125	0,130	5.1
0,030	0,035	0,040	0,050	0,055	0,060	0,060	0,065	0,070	0,070	0,075	0,080	1.1
0,035	0,043	0,050	0,055	0,063	0,070	0,065	0,073	0,080	0,075	0,083	0,090	2.1
0,030	0,035	0,040	0,050	0,055	0,060	0,060	0,065	0,070	0,070	0,075	0,080	3.1
0,030	0,035	0,040	0,050	0,055	0,060	0,060	0,065	0,070	0,070	0,075	0,080	4.1
0,080	0,090	0,100	0,100	0,110	0,120	0,130	0,140	0,150	0,160	0,170	0,180	1.1
0,080	0,090	0,100	0,100	0,110	0,120	0,130	0,140	0,150	0,160	0,170	0,180	1.2
0,080	0,090	0,100	0,100	0,110	0,120	0,130	0,140	0,150	0,160	0,170	0,180	2.1
0,070	0,080	0,090	0,090	0,100	0,110	0,120	0,130	0,140	0,150	0,160	0,170	2.2
0,050	0,060	0,070	0,070	0,080	0,090	0,090	0,100	0,110	0,110	0,120	0,130	3.1
0,040	0,050	0,060	0,050	0,060	0,070	0,060	0,075	0,090	0,080	0,095	0,110	3.2
0,050	0,060	0,070	0,070	0,080	0,090	0,090	0,100	0,110	0,110	0,120	0,130	4.1
0,040	0,050	0,060	0,050	0,060	0,070	0,060	0,075	0,090	0,080	0,095	0,110	4.2
0,070	0,075	0,080	0,100	0,110	0,120	0,130	0,140	0,150	0,160	0,170	0,180	1.1
0,070	0,075	0,080	0,100	0,110	0,120	0,130	0,140	0,150	0,160	0,170	0,180	1.2
0,070	0,075	0,080	0,100	0,110	0,120	0,130	0,140	0,150	0,160	0,170	0,180	1.3
0,070	0,075	0,080	0,100	0,110	0,120	0,130	0,140	0,150	0,160	0,170	0,180	1.4
0,060	0,065	0,070	0,090	0,100	0,110	0,120	0,130	0,140	0,150	0,160	0,170	1.5
0,060	0,065	0,070	0,090	0,100	0,110	0,120	0,130	0,140	0,150	0,160	0,170	1.6
												2.1
0,050	0,060	0,070	0,080	0,095	0,110	0,110	0,125	0,140	0,140	0,155	0,170	2.2
0,050	0,060	0,070	0,080	0,095	0,110	0,110	0,125	0,140	0,140	0,155	0,170	2.3
												2.4
												2.5
												2.6
												2.7
												2.8
												3.1
												3.2
												4.1
												4.2
												4.3
												4.4
												5.1
												5.2
												5.3
0,030	0,040	0,050	0,040	0,050	0,060	0,055	0,065	0,075	0,065	0,075	0,085	1.1
0,030	0,040	0,050	0,040	0,050	0,060	0,055	0,065	0,075	0,065	0,075	0,085	1.2
0,030	0,040	0,050	0,040	0,050	0,060	0,055	0,065	0,075	0,065	0,075	0,085	1.3
												2.1
												2.2
												2.3
												2.4
												2.5
												2.6
												1.1
												1.2
												1.3
												1.4
												1.5

- Product Finder
- v_c / f
- STEEL
- VA
- GG
- HCUT
- Zubehör Accessories
- Tech. Info

- 3 x D
- 5 x D
- 6 x D
- 8 x D
- 2-3,5 x D





EF-Drill STEEL
3 x D

EF-Drill STEEL
3 x D

EF-Drill STEEL
5 x D

EF-Drill STEEL
8 x D

EF-Drill C STEEL
2 - 3,5 x D

Schnittgeschwindigkeit v_c [m/min] - Cutting speed v_c [m/min]

	min.	empf. rec.	max.	min.	empf. rec.	max.	min.	empf. rec.	max.	min.	empf. rec.	max.	min.	empf. rec.	max.
--	------	------------	------	------	------------	------	------	------------	------	------	------------	------	------	------------	------

P	1.1	100	120	140	140	160	200	140	160	200	120	140	160	140	160	200
	2.1	85	100	115	120	145	170	120	145	170	95	115	135	120	145	170
	3.1	70	85	100	100	120	140	100	120	140	90	100	115	100	120	140
	4.1	60	70	80	80	100	120	80	100	120	70	85	100	80	100	120
	5.1	45	55	65	60	70	80	60	70	80	50	60	70	60	70	80
M	1.1				60	80	100	60	80	100	55	70	90	60	80	100
	2.1															
	3.1															
	4.1															
	5.1															
K	1.1	120	150	180	130	160	190	130	160	190	115	140	165	130	160	190
	1.2	100	130	150	110	140	160	110	140	160	95	125	140	110	140	160
	2.1	100	130	160	110	140	170	110	140	170	95	125	150	110	140	170
	2.2	100	120	140	120	140	160	120	140	160	105	125	140	120	140	160
	3.1	70	80	90	70	90	100	70	90	100	60	80	90	70	90	100
	3.2	70	80	90	70	90	100	70	90	100	60	80	90	70	90	100
	4.1	110	130	150	120	140	160	120	140	160	105	125	140	120	140	160
	4.2	90	110	130	100	120	140	100	120	140	90	105	125	100	120	140
	5.1															
N	1.1	210	240	270	220	260	280	220	260	280	195	230	245	220	260	280
	1.2	210	240	270	220	260	280	220	260	280	195	230	245	220	260	280
	1.3	180	200	220	200	230	260	200	230	260	175	200	230	200	230	260
	1.4	180	200	220	200	230	260	200	230	260	175	200	230	200	230	260
	1.5	150	170	180	165	185	200	165	185	200	145	165	175	165	185	200
	1.6															
	2.1	110	130	160	115	135	170	115	135	170	100	120	150	115	135	170
	2.2	150	160	170	160	175	190	160	175	190	140	155	165	160	175	190
	2.3	180	210	240	190	220	250	190	220	250	165	195	220	190	220	250
	2.4	60	80	90	70	90	110	70	90	110	60	80	95	70	90	110
	2.5	90	110	140	120	160	180	120	160	180	110	140	160	120	160	180
	2.6	90	100	110	100	115	130	100	115	130	90	100	115	100	115	130
	2.7	50	55	60	60	65	70	60	65	70	50	55	60	60	65	70
	2.8	50	55	60	65	70	75	65	70	75	55	60	65	65	70	75
	3.1															
	3.2															
4.1																
4.2																
4.3																
4.4																
5.1	70	90	120													
5.2																
5.3																
S	1.1															
	1.2															
	1.3															
	2.1															
	2.2															
	2.3															
	2.4															
2.5																
2.6																
H	1.1	30	35	40	35	40	45	35	40	45			35	40	45	
	1.2	20	25	30	30	35	40	30	35	40			30	35	40	
	1.3															
	1.4															
	1.5															



Schnittwerte

Bei diesen Angaben handelt es sich um Richtwerte.

- Die fett gedruckten Richtwerte (**empf.**) sind bei stabilen Verhältnissen für leistungsfähige Werkzeugmaschinen mit ausreichend hohem Drehzahlniveau zu empfehlen.
- Entsprechend gelten die niedrigeren Schnittgeschwindigkeiten (**min.**) in Verbindung mit höheren Vorschubwerten (bis **max.**) für Werkzeugmaschinen mit niedrigeren Spindeldrehzahlen.
- Für optimale Werkstückverhältnisse und sehr leistungsfähige, hochdrehende Werkzeugmaschinen können die hohen Schnittgeschwindigkeiten (**max.**) bei ggf. reduzierten Vorschüben die beste Wahl sein.

EF-Drill-STEEL 8 x D:

- Eine Vorzentrierung durch den Einsatz eines Pilotbohrers wird empfohlen.
- Die angegebenen Werte für den Vorschub pro Umdrehung f [mm/U] sind um 15% zu reduzieren!

Cutting data

Please note that these data are standard values only.

- We recommend the standard values in bold print (**rec.**) for stable work conditions and for high-performance machine tools with sufficient speed capability.
- Correspondingly, the lower cutting speeds (**min.**) in connection with higher feed values (up to **max.**) should be used for machine tools with lower spindle speeds.
- For optimum workpiece conditions, and for machine tools with extremely high performance and high spindle speeds, the high cutting speeds (**max.**) in connection with possibly reduced feed values can be applied.

EF-Drill-STEEL 8 x D:

- Preparatory centering with a pilot drill is recommended.
- Reduce the recommended feed per revolution value f [mm/rev.] by 15%!

D = 3 mm			D = 5 mm			D = 8 mm			D = 10 mm			D = 12 mm			D = 16 mm			D = 20 mm			
Vorschub pro Umdrehung f [mm/U] · Feed per revolution f [mm/rev.]																					
min.	empf. rec.	max.	min.	empf. rec.	max.	min.	empf. rec.	max.	min.	empf. rec.	max.	min.	empf. rec.	max.	min.	empf. rec.	max.	min.	empf. rec.	max.	
0,08	0,11	0,13	0,11	0,15	0,19	0,14	0,18	0,25	0,20	0,24	0,29	0,22	0,25	0,32	0,25	0,31	0,38	0,29	0,35	0,42	1.1
0,08	0,10	0,12	0,09	0,11	0,14	0,15	0,18	0,21	0,17	0,21	0,24	0,20	0,24	0,27	0,24	0,28	0,32	0,28	0,32	0,36	2.1
0,08	0,10	0,12	0,09	0,11	0,14	0,15	0,18	0,21	0,17	0,21	0,24	0,20	0,24	0,27	0,24	0,28	0,32	0,28	0,32	0,36	3.1
0,06	0,08	0,10	0,08	0,10	0,14	0,12	0,16	0,18	0,15	0,18	0,21	0,16	0,20	0,24	0,18	0,24	0,30	0,22	0,28	0,34	4.1
0,03	0,06	0,08	0,06	0,08	0,10	0,10	0,12	0,15	0,11	0,14	0,17	0,14	0,16	0,18	0,17	0,20	0,23	0,21	0,24	0,27	5.1
0,04	0,06	0,08	0,07	0,09	0,10	0,09	0,11	0,13	0,11	0,14	0,17	0,15	0,19	0,22	0,18	0,22	0,26	0,22	0,26	0,30	1.1
																					3.1
																					4.1
0,12	0,16	0,20	0,17	0,22	0,26	0,24	0,30	0,34	0,27	0,33	0,39	0,30	0,36	0,46	0,35	0,41	0,52	0,39	0,45	0,56	1.1
0,10	0,13	0,16	0,15	0,19	0,23	0,20	0,26	0,32	0,23	0,29	0,35	0,26	0,34	0,42	0,32	0,38	0,50	0,36	0,42	0,54	1.2
0,10	0,14	0,17	0,15	0,20	0,24	0,21	0,27	0,33	0,24	0,30	0,36	0,27	0,35	0,43	0,33	0,39	0,51	0,37	0,43	0,55	2.1
0,09	0,12	0,15	0,13	0,17	0,21	0,16	0,22	0,28	0,18	0,23	0,29	0,20	0,27	0,32	0,24	0,31	0,37	0,28	0,35	0,41	2.2
0,10	0,12	0,14	0,13	0,15	0,19	0,17	0,21	0,26	0,21	0,26	0,31	0,27	0,32	0,37	0,32	0,37	0,41	0,36	0,41	0,45	3.1
0,10	0,12	0,14	0,13	0,15	0,19	0,17	0,21	0,26	0,21	0,26	0,31	0,27	0,32	0,37	0,32	0,37	0,41	0,36	0,41	0,45	3.2
0,10	0,13	0,16	0,14	0,17	0,21	0,18	0,24	0,30	0,22	0,30	0,34	0,24	0,32	0,40	0,28	0,38	0,46	0,32	0,42	0,50	4.1
0,09	0,12	0,15	0,12	0,16	0,20	0,16	0,21	0,27	0,20	0,27	0,31	0,22	0,29	0,36	0,27	0,34	0,42	0,31	0,38	0,46	4.2
0,12	0,14	0,17	0,18	0,22	0,25	0,24	0,28	0,32	0,30	0,35	0,40	0,38	0,43	0,48	0,45	0,52	0,60	0,49	0,56	0,64	1.1
0,12	0,14	0,17	0,18	0,22	0,25	0,24	0,28	0,32	0,30	0,35	0,40	0,38	0,43	0,48	0,45	0,52	0,60	0,49	0,56	0,64	1.2
0,12	0,14	0,17	0,18	0,22	0,25	0,24	0,28	0,32	0,30	0,35	0,40	0,38	0,43	0,48	0,45	0,52	0,60	0,49	0,56	0,64	1.3
0,12	0,14	0,17	0,18	0,22	0,25	0,24	0,28	0,32	0,30	0,35	0,40	0,38	0,43	0,48	0,45	0,52	0,60	0,49	0,56	0,64	1.4
0,12	0,14	0,16	0,16	0,18	0,22	0,22	0,26	0,30	0,29	0,34	0,38	0,35	0,39	0,44	0,40	0,45	0,50	0,44	0,49	0,54	1.5
																					1.6
0,07	0,09	0,14	0,09	0,12	0,16	0,13	0,16	0,18	0,16	0,19	0,23	0,18	0,22	0,27	0,21	0,26	0,30	0,25	0,30	0,34	2.1
0,06	0,09	0,11	0,12	0,14	0,16	0,16	0,20	0,24	0,20	0,24	0,28	0,24	0,28	0,32	0,28	0,33	0,37	0,32	0,37	0,41	2.2
0,12	0,14	0,16	0,14	0,16	0,20	0,20	0,25	0,30	0,24	0,30	0,38	0,28	0,36	0,41	0,32	0,38	0,45	0,36	0,42	0,49	2.3
0,05	0,07	0,08	0,07	0,09	0,11	0,12	0,14	0,16	0,14	0,16	0,20	0,16	0,18	0,22	0,18	0,20	0,25	0,22	0,24	0,29	2.4
0,06	0,08	0,10	0,08	0,12	0,14	0,14	0,18	0,20	0,16	0,20	0,24	0,20	0,23	0,26	0,22	0,25	0,30	0,26	0,29	0,34	2.5
0,07	0,09	0,11	0,09	0,11	0,13	0,15	0,17	0,20	0,18	0,21	0,23	0,21	0,24	0,27	0,24	0,28	0,32	0,28	0,32	0,36	2.6
0,03	0,04	0,05	0,04	0,05	0,07	0,08	0,09	0,10	0,09	0,10	0,12	0,10	0,12	0,14	0,12	0,14	0,16	0,16	0,18	0,20	2.7
0,03	0,04	0,05	0,04	0,05	0,07	0,08	0,09	0,10	0,09	0,10	0,12	0,10	0,12	0,14	0,12	0,14	0,16	0,16	0,18	0,20	2.8
																					3.1
																					3.2
																					4.1
																					4.2
																					4.3
																					4.4
0,10	0,12	0,14	0,12	0,14	0,16	0,14	0,16	0,18	0,16	0,19	0,21	0,18	0,21	0,24	0,20	0,24	0,28	0,24	0,28	0,32	5.1
																					5.2
																					5.3
																					1.1
																					1.2
																					1.3
																					2.1
																					2.2
																					2.3
																					2.4
																					2.5
																					2.6
0,04	0,06	0,08	0,06	0,07	0,08	0,10	0,12	0,14	0,12	0,14	0,16	0,14	0,16	0,18	0,16	0,18	0,20	0,20	0,22	0,24	1.1
0,03	0,05	0,06	0,04	0,06	0,07	0,08	0,10	0,12	0,10	0,12	0,14	0,12	0,14	0,16	0,14	0,16	0,18	0,18	0,20	0,22	1.2
																					1.3
																					1.4
																					1.5

- Product Finder
- v_c / f
- STEEL
- VA
- GG
- HCU
- Zubehör Accessories
- Tech. Info

- 3 x D
- 5 x D
- 6 x D
- 8 x D
- 2-3,5 x D





EF-Drill Modular
 STEEL
 3 x D

EF-Drill Modular
 STEEL
 5 x D

Schnittgeschwindigkeit v_c [m/min] · Cutting speed v_c [m/min]

		min.	empf. rec.	max.	min.	empf. rec.	max.
P	1.1	100	140	140	100	140	140
	2.1	90	115	130	90	115	130
	3.1	70	100	110	70	100	110
	4.1	60	80	100	60	80	100
	5.1	50	60	70	50	60	70
M	1.1	40	50	60	40	50	60
	2.1						
	3.1						
	4.1						
K	1.1	100	120	165	100	120	165
	1.2	85	125	140	85	125	140
	2.1	85	125	150	85	125	150
	2.2	90	125	140	90	125	140
	3.1	50	70	90	50	70	90
	3.2	50	70	90	50	70	90
	4.1	90	125	140	90	125	140
	4.2	90	90	125	90	90	125
N	1.1						
	1.2						
	1.3						
	1.4	100	150	200	100	150	200
	1.5	80	120	160	80	120	160
	1.6						
	2.1						
	2.2						
	2.3						
	2.4						
	2.5						
	2.6						
	2.7						
	2.8						
	3.1						
	3.2						
4.1							
4.2							
4.3							
4.4							
5.1							
5.2							
5.3							
S	1.1						
	1.2						
	1.3						
	2.1						
	2.2						
	2.6						
H	1.1						
	1.2						
	1.3						
	1.4						
	1.5						

3 x D
 5 x D
 6 x D
 8 x D
 2-3,5 x D



Schnittwerte

Bei diesen Angaben handelt es sich um Richtwerte.

- Die fett gedruckten Richtwerte (**empf.**) sind bei stabilen Verhältnissen für leistungsfähige Werkzeugmaschinen mit ausreichend hohem Drehzahlniveau zu empfehlen.
- Entsprechend gelten die niedrigeren Schnittgeschwindigkeiten (**min.**) in Verbindung mit höheren Vorschubwerten (bis **max.**) für Werkzeugmaschinen mit niedrigeren Spindeldrehzahlen.
- Für optimale Werkstückverhältnisse und sehr leistungsfähige, hochdrehende Werkzeugmaschinen können die hohen Schnittgeschwindigkeiten (**max.**) bei ggf. reduzierten Vorschüben die beste Wahl sein.

Cutting data

Please note that these data are standard values only.

- We recommend the standard values in bold print (**rec.**) for stable work conditions and for high-performance machine tools with sufficient speed capability.
- Correspondingly, the lower cutting speeds (**min.**) in connection with higher feed values (up to **max.**) should be used for machine tools with lower spindle speeds.
- For optimum workpiece conditions, and for machine tools with extremely high performance and high spindle speeds, the high cutting speeds (**max.**) in connection with possibly reduced feed values can be applied.

D = 14 mm			D = 16 mm			D = 20 mm			D = 24 mm			D = 28 mm			D = 32 mm			
Vorschub pro Umdrehung f [mm/U] · Feed per revolution f [mm/rev.]																		
min.	empf. rec.	max.	min.	empf. rec.	max.	min.	empf. rec.	max.	min.	empf. rec.	max.	min.	empf. rec.	max.	min.	empf. rec.	max.	
0,15	0,22	0,28	0,18	0,25	0,31	0,21	0,28	0,34	0,26	0,33	0,39	0,30	0,37	0,43	0,34	0,41	0,47	1.1
0,16	0,23	0,30	0,19	0,26	0,33	0,22	0,29	0,36	0,27	0,34	0,41	0,31	0,38	0,45	0,35	0,42	0,49	2.1
0,22	0,27	0,31	0,25	0,30	0,34	0,28	0,33	0,37	0,33	0,38	0,42	0,37	0,42	0,46	0,41	0,46	0,50	3.1
0,17	0,22	0,27	0,20	0,25	0,30	0,23	0,28	0,33	0,28	0,33	0,38	0,32	0,37	0,42	0,36	0,41	0,46	4.1
0,16	0,21	0,26	0,19	0,24	0,29	0,22	0,27	0,32	0,27	0,32	0,37	0,31	0,36	0,41	0,35	0,40	0,45	5.1
0,13	0,17	0,20	0,15	0,19	0,22	0,17	0,21	0,24	0,20	0,24	0,27	0,22	0,26	0,29	0,24	0,28	0,31	1.1
																		3.1
																		4.1
0,23	0,33	0,43	0,31	0,41	0,51	0,39	0,49	0,59	0,49	0,59	0,69	0,57	0,67	0,77	0,65	0,75	0,85	1.1
0,19	0,30	0,40	0,27	0,38	0,48	0,35	0,46	0,56	0,45	0,56	0,66	0,53	0,64	0,74	0,61	0,72	0,82	1.2
0,21	0,31	0,40	0,29	0,39	0,48	0,37	0,47	0,56	0,47	0,57	0,66	0,55	0,65	0,74	0,63	0,73	0,82	2.1
0,17	0,28	0,38	0,25	0,36	0,46	0,33	0,44	0,54	0,43	0,54	0,64	0,51	0,62	0,72	0,59	0,70	0,80	2.2
0,15	0,24	0,33	0,23	0,32	0,41	0,31	0,40	0,49	0,41	0,50	0,59	0,49	0,58	0,67	0,57	0,66	0,75	3.1
0,15	0,24	0,33	0,23	0,32	0,41	0,31	0,40	0,49	0,41	0,50	0,59	0,49	0,58	0,67	0,57	0,66	0,75	3.2
0,14	0,22	0,29	0,22	0,30	0,37	0,30	0,38	0,45	0,40	0,48	0,55	0,48	0,56	0,63	0,56	0,64	0,71	4.1
0,13	0,20	0,27	0,21	0,28	0,35	0,29	0,36	0,43	0,39	0,46	0,53	0,47	0,54	0,61	0,55	0,62	0,69	4.2
																		1.1
																		1.2
																		1.3
0,30	0,35	0,40	0,35	0,40	0,45	0,40	0,45	0,50	0,45	0,50	0,55	0,50	0,55	0,60	0,55	0,60	0,65	1.4
0,40	0,45	0,50	0,45	0,50	0,55	0,50	0,55	0,60	0,55	0,60	0,65	0,60	0,65	0,70	0,65	0,70	0,75	1.5
																		1.6
																		2.1
																		2.2
																		2.3
																		2.4
																		2.5
																		2.6
																		2.7
																		2.8
																		3.1
																		3.2
																		4.1
																		4.2
																		4.3
																		4.4
																		5.1
																		5.2
																		5.3
																		1.1
																		1.2
																		1.3
																		2.1
																		2.2
																		2.3
																		2.4
																		2.5
																		2.6
																		1.1
																		1.2
																		1.3
																		1.4
																		1.5

- Product Finder
- v_c / f
- STEEL
- VA
- GG
- HCUT
- Zubehör Accessories
- Tech. Info

- 3 x D
- 5 x D
- 6 x D
- 8 x D
- 2-3,5 x D





EF-Drill
VA
3 x D

EF-Drill
VA
5 x D

EF-Drill C
VA
2 - 3,5 x D

EF-Drill
GG
5 x D

EF-Drill
HCUT
3 x D

Schnittgeschwindigkeit v_c [m/min] · Cutting speed v_c [m/min]

	min.	empf. rec.	max.	min.	empf. rec.	max.	min.	empf. rec.	max.	min.	empf. rec.	max.	min.	empf. rec.	max.
--	------	------------	------	------	------------	------	------	------------	------	------	------------	------	------	------------	------

P	1.1														
	2.1														
	3.1														
	4.1														
	5.1														
M	1.1	60	80	100	60	80	100	60	80	100					
	2.1	40	50	60	40	50	60	40	50	60					
	3.1	35	40	45	35	40	45	35	40	45					
	4.1	30	35	40	30	35	40	30	35	40					
K	1.1										140	180	210		
	1.2										120	150	180		
	2.1										120	150	190		
	2.2										110	130	150		
	3.1										80	100	110		
	3.2										80	100	110		
	4.1										130	150	180		
4.2										110	130	150			
N	1.1	220	260	280	220	260	280	220	260	280					
	1.2	220	260	280	220	260	280	220	260	280					
	1.3	200	230	260	200	230	260	200	230	260					
	1.4														
	1.5														
	1.6														
	2.1														
	2.2														
	2.3														
	2.4														
	2.5														
	2.6														
	2.7														
	2.8														
	3.1														
	3.2														
4.1															
4.2															
4.3															
4.4															
5.1															
5.2															
5.3															
S	1.1	45	55	65	45	55	65	45	55	65					
	1.2	30	45	55	30	45	55	30	45	55					
	1.3	30	35	40	30	35	40	30	35	40					
	2.1														
	2.2	10	20	30	10	20	30	10	20	30					
	2.3														
2.4	30	45	55	30	45	55	30	45	55						
2.5															
2.6	30	35	40	30	35	40	30	35	40						
H	1.1												30	35	40
	1.2												20	25	30
	1.3												15	20	25
	1.4												10	15	20
	1.5												8	12	15



- Product Finder
- v_c / f
- STEEL
- VA
- GG
- HCUT
- Zubehör
Accessories
- Tech. Info

- 3 x D
- 5 x D
- 6 x D
- 8 x D
- 2-3,5 x D

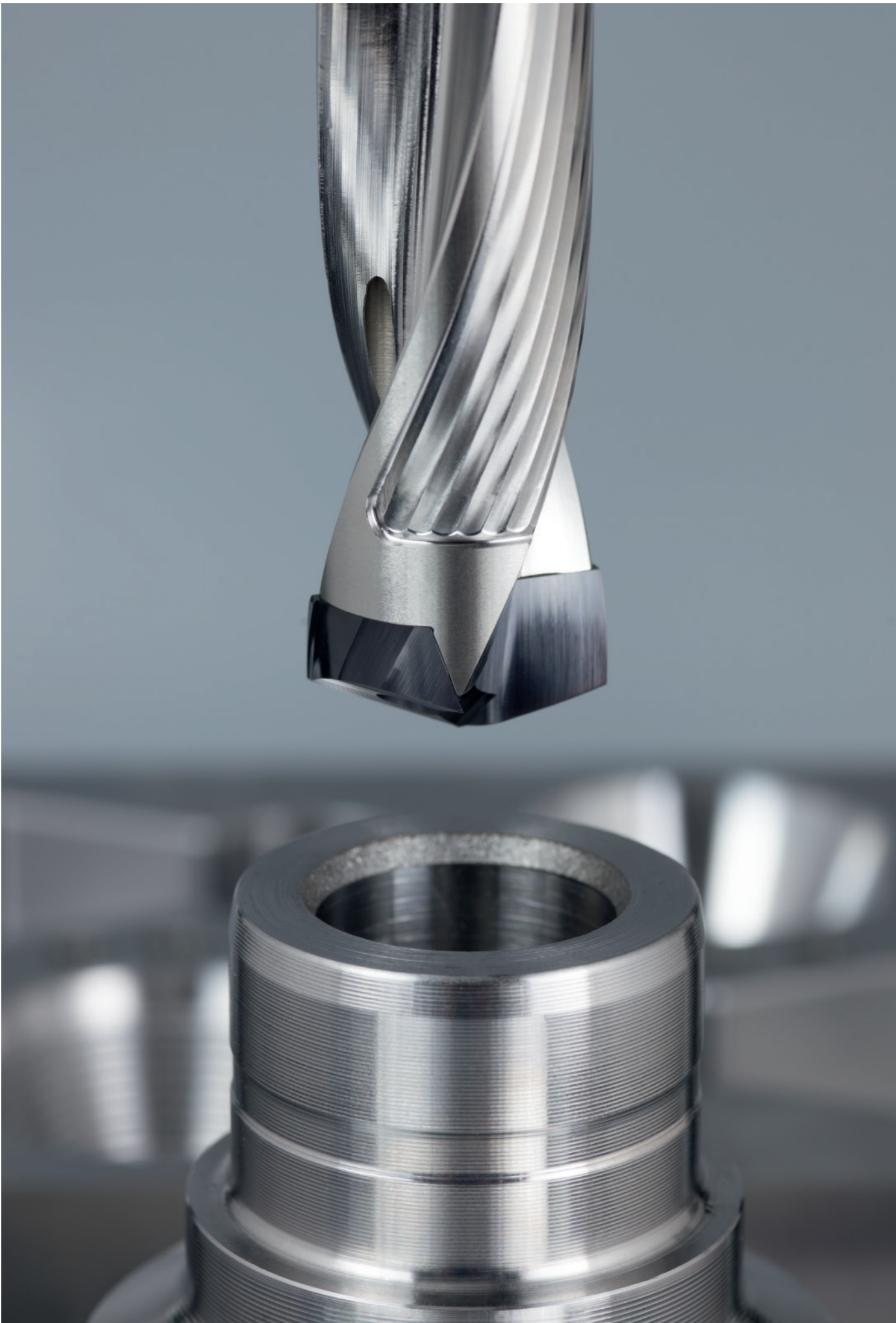

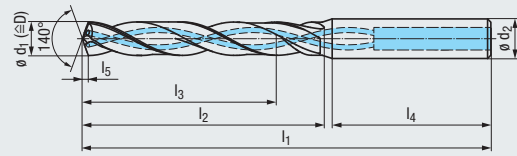

VHM TIALN T99 R30 Z2 2FF 140° IT9-IT10 DIN 6535 HA

STEEL
Steel materials

new

- Product Finder
- v_c / f
- STEEL
- VA
- GG
- HCUT
- Zubehör Accessories
- Tech. Info

Bohrtiefe
Drill depth

6 x D

Einsatzgebiete – Material
Applications – material

P 1.1-5.1 M 1.1-4.1 K 1.1-4.2
N 1.1-6 N 2.2-3 S 1.2-3

Werkzeug-Ident · Tool ident

TE213324

$\varnothing d_1$ k5	Gewindebohrer Taps	Gewindeformer Cold-forming taps	Dimens.-Ident							EF-Drill Micro-STEEL HA-1K-2FF TIALN-T99
			l_1	l_2	l_3	l_4	l_5	$\varnothing d_2$		
0,75	M1		51,5	5,7	4,5	28	0,105	3	.0075	●
0,80	M1x0,2		51,5	6,1	4,8	28	0,112	3	.0080	●
0,85	M1,1		51,5	6,5	5,1	28	0,119	3	.0085	●
0,90	M1,1x,2	M1	51,5	6,9	5,4	28	0,126	3	.0090	●
0,95	M1,2		51,5	7,3	5,7	28	0,132	3	.0095	●
1,00	M1,2x0,2	M1,1	55	7,7	6	28	0,139	4	.0100	●
1,10	M1,4	M1,2	55	8,5	6,6	28	0,153	4	.0110	●
1,20	M1,4x0,2		55	9,3	7,2	28	0,167	4	.0120	●
1,25	M1,6		55	9,7	7,5	28	0,174	4	.0125	●
1,28		M1,4	55	9,7	7,7	28	0,178	4	.0128	●
1,30	MJ1,6x0,35		57	10,1	7,8	28	0,181	4	.0130	●
1,35	M1,7		57	10,5	8,1	28	0,188	4	.0135	●
1,40	M1,6x0,2		57	10,9	8,4	28	0,195	4	.0140	●
1,45	M1,8		57	11,3	8,7	28	0,202	4	.0145	●
1,47		M1,6	57	11,3	8,8	28	0,202	4	.0147	●
1,50			57	11,7	9	28	0,209	4	.0150	●
1,57		M1,7	59	11,7	9,4	28	0,219	4	.0157	●
1,60	M2 / M1,8x0,2		59	12,5	9,6	28	0,223	4	.0160	●
1,67		M1,8	59	12,5	10	28	0,233	4	.0167	●
1,70			59	13,3	10,2	28	0,237	4	.0170	●
1,75	M2,2 / M2x0,25		59	13,7	10,5	28	0,244	4	.0175	●
1,80			61	14,1	10,8	28	0,251	4	.0180	●
1,85		M2	61	14,5	11,1	28	0,258	4	.0185	●
1,90	M2,3	M2x0,25	61	14,9	11,4	28	0,265	4	.0190	●
1,95	M2,2x0,25 / M2,3x0,35		61	15,3	11,7	28	0,272	4	.0195	●
2,00			63	15,7	12	28	0,279	4	.0200	●
2,03		M2,2	63	15,7	12,2	28	0,283	4	.0203	●
2,05	M2,5 / M2,3x0,25		63	16,1	12,3	28	0,286	4	.0205	●
2,10	MJ2,5x0,45	M2,2x0,25	63	16,5	12,6	28	0,293	4	.0210	●
2,15	M2,6 / M2,5x0,35	M2,3	63	16,9	12,9	28	0,300	4	.0215	●
2,20		M2,3x0,25	63	17,3	13,2	28	0,307	4	.0220	●
2,30			65	18,1	13,8	28	0,321	4	.0230	●
2,33		M2,5	65	18,1	14	28	0,325	4	.0233	●
2,40		M2,5x0,25	65	18,9	14,4	28	0,335	4	.0240	●
2,43		M2,6	65	18,9	14,6	28	0,339	4	.0243	●
2,50	M3	M2,6x0,25	65	19,7	15	28	0,349	4	.0250	●
2,60	MJ3x0,5		66,5	20,5	15,6	28	0,363	4	.0260	●
2,65	M3x0,35		66,5	20,9	15,9	28	0,370	4	.0265	●
2,70			66,5	21,3	16,2	28	0,377	4	.0270	●
2,80		M3	68,5	22,1	16,8	28	0,390	4	.0280	●
2,90	M3,5	M3x0,25	68,5	22,9	17,4	28	0,404	4	.0290	●
3,00	M3,5x0,5 / MJ3,5x0,6		73	23,7	18	36	0,418	4	.0300	●

- 3 x D
- 5 x D
- 6 x D
- 8 x D
- 2-3,5 x D



● = Lagerwerkzeug, siehe Preisliste · Stock tool, see price list
○ = Kurzfristig lieferbar, Preis auf Anfrage · Available on short notice, price upon inquiry

- Product Finder
- v_c / f
- STEEL
- VA
- GG
- HCUT
- Zubehör Accessories
- Tech. Info

VHM **TIALN T14**

DIN 6537 K **R30**

Z2 **2FF**

140° **IT9-IT10**

DIN 6535
 HA 
 HE 

STEEL
Steel materials

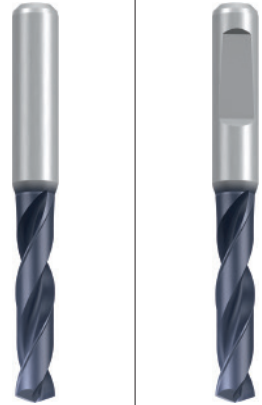

Kurze Ausführung
Short design

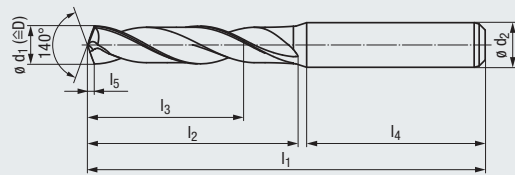

Bohrtiefe
Drill depth

3 x D

Einsatzgebiete – Material
Applications – material  510

P 1.1-5.1 **K** 1.1-4.2 **N** 1.1-5
N 2.1-8 **N** 5.1 **H** 1.1-2

Werkzeug-Ident · Tool ident

TA103324 **TA403324**

ϕd_1 m7	Gewindebohrer Taps	Gewindeformer Cold-forming taps						ϕd_2 h6	Dimens.- Ident	EF-Drill-STEEL DIN6537K-HA AK-2FF TIALN-T14	EF-Drill-STEEL DIN6537K-HE AK-2FF TIALN-T14
			l_1	l_2	l_3	l_4	l_5			TA103324	TA403324
2,80		M3	57	16	11	36	0,6	6	.0280	●	●
2,85			57	16	11	36	0,6	6	.0285	●	●
2,90	M3,5	M3x0,25	57	16	11	36	0,6	6	.0290	●	●
3,00	M3,5x0,5 / MJ3,5x0,6		62	20	14	36	0,6	6	.0300	●	●
3,10			62	20	14	36	0,6	6	.0310	●	●
3,15	M3,5x0,35		62	20	14	36	0,6	6	.0315	●	●
3,20	MJ3,5x0,35		62	20	14	36	0,6	6	.0320	●	●
3,25		M3,5	62	20	14	36	0,6	6	.0325	●	●
3,30	M4	M3,5x0,5	62	20	14	36	0,7	6	.0330	●	●
3,35			62	20	14	36	0,7	6	.0335	●	●
3,38		M3,5x0,35	62	20	14	36	0,7	6	.0338	●	●
3,40	MJ4x0,7		62	20	14	36	0,7	6	.0340	●	●
3,50	M4x0,5		62	20	14	36	0,7	6	.0350	●	●
3,55			62	20	14	36	0,7	6	.0355	●	●
3,60	MJ4x0,5		62	20	14	36	0,7	6	.0360	●	●
3,65	M4x0,35		62	20	14	36	0,7	6	.0365	●	●
3,70	M4,5	M4	62	20	14	36	0,7	6	.0370	●	●
3,80		M4x0,5	66	24	17	36	0,7	6	.0380	●	●
3,88		M4x0,35	66	24	17	36	0,8	6	.0388	●	●
3,90	MJ4,5x0,75		66	24	17	36	0,8	6	.0390	●	●
4,00			66	24	17	36	0,8	6	.0400	●	●
4,10	MJ4,5x0,5		66	24	17	36	0,8	6	.0410	●	●
4,15	M5x0,9		66	24	17	36	0,8	6	.0415	●	●
4,20	M5 / M5x0,75	M4,5	66	24	17	36	0,8	6	.0420	●	●
4,30	MJ5x0,8	M4,5x0,5	66	24	17	36	0,8	6	.0430	●	●
4,35			66	24	17	36	0,8	6	.0435	●	●
4,40			66	24	17	36	0,9	6	.0440	●	●
4,45			66	24	17	36	0,9	6	.0445	●	●
4,50	M5x0,5		66	24	17	36	0,9	6	.0450	●	●
4,60	M5,5 / MJ5x0,5		66	24	17	36	0,9	6	.0460	●	●
4,65		M5	66	24	17	36	0,9	6	.0465	●	●
4,70		M5x0,75	66	24	17	36	0,9	6	.0470	●	●
4,80		M5x0,5	66	28	20	36	0,9	6	.0480	●	●
4,90			66	28	20	36	0,9	6	.0490	●	●
5,00	M6		66	28	20	36	1,0	6	.0500	●	●
5,10	MJ6x1	M5,5	66	28	20	36	1,0	6	.0510	●	●
5,20	M6x0,75		66	28	20	36	1,0	6	.0520	●	●
5,25			66	28	20	36	1,0	6	.0525	●	●
5,30		M5,5x0,5	66	28	20	36	1,0	6	.0530	●	●
5,40			66	28	20	36	1,0	6	.0540	●	●
5,50	M6x0,5		66	28	20	36	1,1	6	.0550	●	●
5,55		M6 (GAL)	66	28	20	36	1,1	6	.0555	●	●
5,60	MJ6x0,5	M6	66	28	20	36	1,1	6	.0560	●	●

Kurze Ausführung
Short design

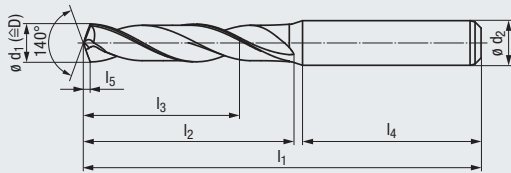

VHM **TIALN T14**

DIN 6537 K **R30**

Z2 **2FF**

140° **IT9-IT10**

DIN 6535
HA HE

STEEL
Steel materials

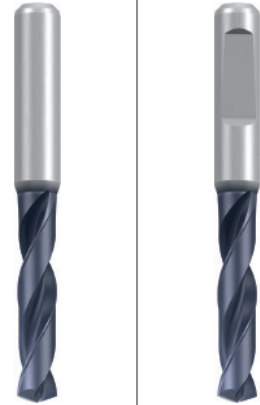

- Product Finder
- v_c / f
- STEEL
- VA
- GG
- HCUT
- Zubehör Accessories
- Tech. Info

Bohrtiefe
Drill depth

3 x D

Einsatzgebiete – Material
Applications – material 510

P 1.1-5.1 **K** 1.1-4.2 **N** 1.1-5
N 2.1-8 **N** 5.1 **H** 1.1-2

Werkzeug-Ident · Tool ident

TA103324 TA403324

$\varnothing d_1$ m7	Gewindebohrer Taps	Gewindeformer Cold-forming taps						$\varnothing d_2$ h6	Dimens.- Ident	TA103324	TA403324
			l_1	l_2	l_3	l_4	l_5			EF-Drill-STEEL DIN6537K-HA AK-2FF TIALN-T14	EF-Drill-STEEL DIN6537K-HE AK-2FF TIALN-T14
5,70		M6x0,75	66	28	20	36	1,1	6	.0570	●	●
5,80		M6x0,5	66	28	20	36	1,1	6	.0580	●	●
5,90			66	28	20	36	1,1	6	.0590	●	●
6,00	M7		66	28	20	36	1,1	6	.0600	●	●
6,10	MJ7x1		79	34	24	36	1,2	8	.0610	●	●
6,20	M7x0,75		79	34	24	36	1,2	8	.0620	●	●
6,30			79	34	24	36	1,2	8	.0630	●	●
6,35	MJ7x0,75		79	34	24	36	1,2	8	.0635	●	●
6,40			79	34	24	36	1,2	8	.0640	●	●
6,50	M7x0,5		79	34	24	36	1,2	8	.0650	●	●
6,60		M7	79	34	24	36	1,3	8	.0660	●	●
6,70		M7x0,75	79	34	24	36	1,3	8	.0670	●	●
6,80	M8	M7x0,5	79	34	24	36	1,3	8	.0680	●	●
6,90	MJ8x1,25		79	34	24	36	1,3	8	.0690	●	●
7,00	M8x1		79	34	24	36	1,3	8	.0700	●	●
7,10	MJ8x1		79	41	29	36	1,3	8	.0710	●	●
7,20	M8x0,75		79	41	29	36	1,4	8	.0720	●	●
7,30			79	41	29	36	1,4	8	.0730	●	●
7,40		M8 (GAL)	79	41	29	36	1,4	8	.0740	●	●
7,45		M8	79	41	29	36	1,4	8	.0745	●	●
7,50	M8x0,5		79	41	29	36	1,4	8	.0750	●	●
7,60		M8x1	79	41	29	36	1,4	8	.0760	●	●
7,70		M8x0,75	79	41	29	36	1,5	8	.0770	●	●
7,80	M9	M8x0,5	79	41	29	36	1,5	8	.0780	●	●
7,90	MJ9x1,25		79	41	29	36	1,5	8	.0790	●	●
8,00	M9x1		79	41	29	36	1,5	8	.0800	●	●
8,10	MJ9x1		89	47	35	40	1,5	10	.0810	●	●
8,20	M9x0,75		89	47	35	40	1,5	10	.0820	●	●
8,30			89	47	35	40	1,6	10	.0830	●	●
8,40		M9 (GAL)	89	47	35	40	1,6	10	.0840	●	●
8,45		M9	89	47	35	40	1,6	10	.0845	●	●
8,50	M10 / M9x0,5		89	47	35	40	1,6	10	.0850	●	●
8,60	MJ10x1,5	M9x1	89	47	35	40	1,6	10	.0860	●	●
8,70		M9x0,75	89	47	35	40	1,6	10	.0870	●	●
8,80	M10x1,25	M9x0,5	89	47	35	40	1,7	10	.0880	●	●
8,90	MJ10x1,25		89	47	35	40	1,7	10	.0890	●	●
9,00	M10x1		89	47	35	40	1,7	10	.0900	●	●
9,10	MJ10x1		89	47	35	40	1,7	10	.0910	●	●
9,20	M10x0,75		89	47	35	40	1,7	10	.0920	●	●
9,30		M10 (GAL)	89	47	35	40	1,7	10	.0930	●	●
9,35	MJ10x0,75	M10	89	47	35	40	1,8	10	.0935	●	●
9,40		M10x1,25 (GAL)	89	47	35	40	1,8	10	.0940	●	●
9,45		M10x1,25	89	47	35	40	1,8	10	.0945	●	●

● = Lagerwerkzeug, siehe Preisliste · Stock tool, see price list
○ = Kurzfristig lieferbar, Preis auf Anfrage · Available on short notice, price upon inquiry

\varnothing 9,50 mm - \varnothing 20,00 mm \rightarrow



- Product Finder
- v_c / f
- STEEL
- VA
- GG
- HCUT
- Zubehör Accessories
- Tech. Info

VHM

TIALN
T14

DIN
6537 K

R30

Z2

2FF

140°

IT9-IT10

DIN 6535

HA

HE

STEEL
Steel materials

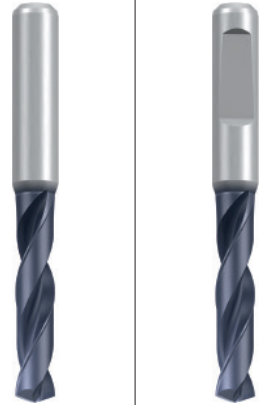

Kurze Ausführung
Short design

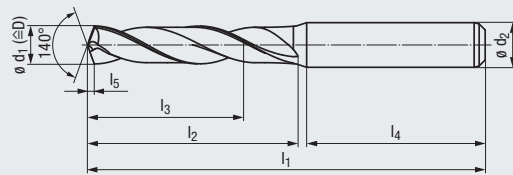

Bohrtiefe
Drill depth

3 x D

Einsatzgebiete – Material
Applications – material



P 1.1-5.1	K 1.1-4.2	N 1.1-5
N 2.1-8	N 5.1	H 1.1-2

Werkzeug-Ident · Tool ident

TA103324 TA403324

$\varnothing d_1$ m7	Gewindebohrer Taps 	Gewindeformer Cold-forming taps 						$\varnothing d_2$ h6	Dimens.- Ident	EF-Drill-STEEL DIN6537K-HA AK-2FF TIALN-T14	EF-Drill-STEEL DIN6537K-HE AK-2FF TIALN-T14
			l_1	l_2	l_3	l_4	l_5			TA103324	TA403324
9,50	M11 / M10x0,5		89	47	35	40	1,8	10	.0950	●	●
9,60	MJ10x0,5 / MJ11x1,5	M10x1	89	47	35	40	1,8	10	.0960	●	●
9,70		M10x0,75	89	47	35	40	1,8	10	.0970	●	●
9,80		M10x0,5	89	47	35	40	1,8	10	.0980	●	●
9,90	MJ11x1,25		89	47	35	40	1,9	10	.0990	●	●
10,00	M11x1		89	47	35	40	1,9	10	.1000	●	●
10,10	MJ11x1		102	55	40	45	1,9	12	.1010	●	●
10,20	M12 / M11x0,75		102	55	40	45	1,9	12	.1020	●	●
10,30		M11 (GAL)	102	55	40	45	1,9	12	.1030	●	●
10,35	MJ11x0,75	M11	102	55	40	45	1,9	12	.1035	●	●
10,40			102	55	40	45	1,9	12	.1040	●	●
10,50	M12x1,5		102	55	40	45	2,0	12	.1050	●	●
10,60	MJ12x1,5	M11x1	102	55	40	45	2,0	12	.1060	●	●
10,70		M11x0,75	102	55	40	45	2,0	12	.1070	●	●
10,80	M12x1,25		102	55	40	45	2,0	12	.1080	●	●
10,90	MJ12x1,25		102	55	40	45	2,0	12	.1090	●	●
11,00	M12x1		102	55	40	45	2,1	12	.1100	●	●
11,10	MJ12x1		102	55	40	45	2,1	12	.1110	●	●
11,20	M12x0,75	M12 (GAL)	102	55	40	45	2,1	12	.1120	●	●
11,25		M12	102	55	40	45	2,1	12	.1125	●	●
11,30		M12x1,5 (GAL)	102	55	40	45	2,1	12	.1130	●	●
11,35		M12x1,5	102	55	40	45	2,1	12	.1135	●	●
11,40		M12x1,25 (GAL)	102	55	40	45	2,1	12	.1140	●	●
11,45		M12x1,25	102	55	40	45	2,1	12	.1145	●	●
11,50			102	55	40	45	2,1	12	.1150	●	●
11,60		M12x1	102	55	40	45	2,2	12	.1160	●	●
11,70		M12x0,75	102	55	40	45	2,2	12	.1170	●	●
11,80			102	55	40	45	2,2	12	.1180	●	●
11,90			102	55	40	45	2,2	12	.1190	●	●
12,00	M14		102	55	40	45	2,2	12	.1200	●	●
12,20			107	60	43	45	2,3	14	.1220	●	●
12,30			107	60	43	45	2,3	14	.1230	●	●
12,50	M14x1,5		107	60	43	45	2,3	14	.1250	●	●
12,60	MJ14x1,5	M13x1	107	60	43	45	2,3	14	.1260	●	●
12,70		M13x0,75	107	60	43	45	2,4	14	.1270	●	●
12,80	M14x1,25		107	60	43	45	2,4	14	.1280	●	●
12,90	MJ14x1,25		107	60	43	45	2,4	14	.1290	●	●
13,00	M14x1		107	60	43	45	2,4	14	.1300	●	●
13,10	MJ14x1	M14	107	60	43	45	2,4	14	.1310	●	●
13,20	M14x0,75		107	60	43	45	2,5	14	.1320	●	●
13,30			107	60	43	45	2,5	14	.1330	●	●
13,35		M14x1,5	107	60	43	45	2,5	14	.1335	●	●
13,45		M14x1,25	107	60	43	45	2,5	14	.1345	●	●

VHM **TIALN T14**

DIN 6537 K **R30**

Z2 **2FF**

140° **IT9-IT10**

DIN 6535
HA HE

STEEL
Steel materials

- Product Finder
- v_c / f
- STEEL**
- VA
- GG
- HCUT
- Zubehör Accessories
- Tech. Info

Kurze Ausführung
Short design

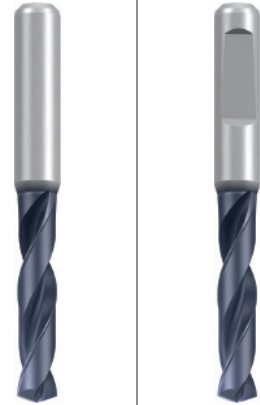
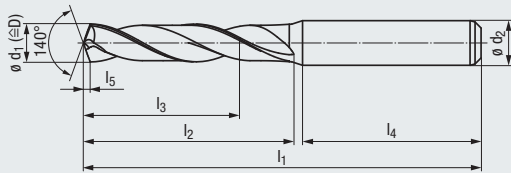

Bohrtiefe
Drill depth

3 x D

Einsatzgebiete – Material
Applications – material 510

P 1.1-5.1 **K** 1.1-4.2 **N** 1.1-5
N 2.1-8 **N** 5.1 **H** 1.1-2

Werkzeug-Ident · Tool ident

TA103324 TA403324

ø d ₁ m7	Gewindebohrer Taps	Gewindeformer Cold-forming taps						ø d ₂ h6	Dimens.- Ident		
			l ₁	l ₂	l ₃	l ₄	l ₅			EF-Drill-STEEL DIN6537K-HA AK-2FF TIALN-T14	EF-Drill-STEEL DIN6537K-HE AK-2FF TIALN-T14
13,50			107	60	43	45	2,5	14	.1350	●	●
13,60	MJ15x1,5	M14x1	107	60	43	45	2,5	14	.1360	●	●
13,70		M14x0,75	107	60	43	45	2,5	14	.1370	●	●
13,80			107	60	43	45	2,6	14	.1380	●	●
14,00	M16 / M15x1		107	60	43	45	2,6	14	.1400	●	●
14,10	MJ15x1		115	65	45	48	2,6	16	.1410	●	●
14,30			115	65	45	48	2,7	16	.1430	●	●
14,40			115	65	45	48	2,7	16	.1440	●	●
14,50	M16x1,5		115	65	45	48	2,7	16	.1450	●	●
14,60	MJ16x1,5	M15x1	115	65	45	48	2,7	16	.1460	●	●
14,70		M15x0,75	115	65	45	48	2,7	16	.1470	●	●
14,80			115	65	45	48	2,7	16	.1480	●	●
15,00	M16x1		115	65	45	48	2,8	16	.1500	●	●
15,10	MJ16x1	M16	115	65	45	48	2,8	16	.1510	●	●
15,35		M16x1,5	115	65	45	48	2,8	16	.1535	●	●
15,50	M18		115	65	45	48	2,9	16	.1550	●	●
15,60		M16x1	115	65	45	48	2,9	16	.1560	●	●
16,00	M18x2		115	65	45	48	3,0	16	.1600	●	●
16,50	M18x1,5		123	73	51	48	3,1	18	.1650	●	●
17,00	M18x1		123	73	51	48	3,1	18	.1700	●	●
17,50	M20		123	73	51	48	3,2	18	.1750	●	●
17,60		M18x1	123	73	51	48	3,3	18	.1760	●	●
18,00	M20x2		123	73	51	48	3,3	18	.1800	●	●
18,50	M20x1,5		131	79	55	50	3,4	20	.1850	●	●
18,85		M20	131	79	55	50	3,5	20	.1885	●	●
19,00	M20x1		131	79	55	50	3,5	20	.1900	●	●
19,35		M20x1,5	131	79	55	50	3,6	20	.1935	●	●
19,50	M22		131	79	55	50	3,6	20	.1950	●	●
19,60		M20x1	131	79	55	50	3,6	20	.1960	●	●
20,00	M22x2		131	79	55	50	3,7	20	.2000	●	●

- 3 x D
- 5 x D
- 6 x D
- 8 x D
- 2-3,5 x D





- Product Finder
- v_c / f
- STEEL
- VA
- GG
- HCUT
- Zubehör Accessories
- Tech. Info

VHM **TIALN T14**

DIN 6537 K **R30**

Z2 **4FF**

140° **IT9-IT10**

DIN 6535
 HA 
 HE 

STEEL
Steel materials



Kurze Ausführung
Short design

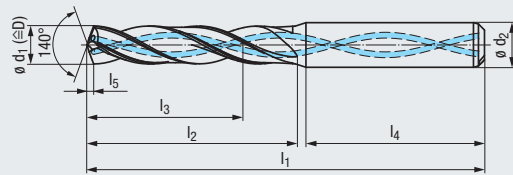

Bohrtiefe
Drill depth

3 x D

Einsatzgebiete – Material
Applications – material  510

P 1.1-5.1 **M** 1.1 **K** 1.1-4.2
N 1.1-5 **N** 2.1-8 **H** 1.1-2

Werkzeug-Ident · Tool ident

TA203344 **TA503344**

θd_1 m7	Gewindebohrer Taps	Gewindeformer Cold-forming taps						θd_2 h6	Dimens.- Ident	EF-Drill-STEEL DIN6537K-HA IK-4FF TIALN-T14	EF-Drill-STEEL DIN6537K-HE IK-4FF TIALN-T14
			l_1	l_2	l_3	l_4	l_5				
2,80		M3	57	16	11	36	0,6	6	.0280	●	●
2,85			57	16	11	36	0,6	6	.0285	●	●
2,90	M3,5	M3x0,25	57	16	11	36	0,6	6	.0290	●	●
3,00	M3,5x0,5 / MJ3,5x0,6		62	20	14	36	0,6	6	.0300	●	●
3,10			62	20	14	36	0,6	6	.0310	●	●
3,15	M3,5x0,35		62	20	14	36	0,6	6	.0315	●	●
3,20	MJ3,5x0,35		62	20	14	36	0,6	6	.0320	●	●
3,25		M3,5	62	20	14	36	0,6	6	.0325	●	●
3,30	M4	M3,5x0,5	62	20	14	36	0,7	6	.0330	●	●
3,35			62	20	14	36	0,7	6	.0335	●	●
3,38		M3,5x0,35	62	20	14	36	0,7	6	.0338	●	●
3,40	MJ4x0,7		62	20	14	36	0,7	6	.0340	●	●
3,50	M4x0,5		62	20	14	36	0,7	6	.0350	●	●
3,55			62	20	14	36	0,7	6	.0355	●	●
3,60	MJ4x0,5		62	20	14	36	0,7	6	.0360	●	●
3,65	M4x0,35		62	20	14	36	0,7	6	.0365	●	●
3,70	M4,5	M4	62	20	14	36	0,7	6	.0370	●	●
3,80		M4x0,5	66	24	17	36	0,7	6	.0380	●	●
3,88		M4x0,35	66	24	17	36	0,8	6	.0388	●	●
3,90	MJ4,5x0,75		66	24	17	36	0,8	6	.0390	●	●
4,00			66	24	17	36	0,8	6	.0400	●	●
4,10	MJ4,5x0,5		66	24	17	36	0,8	6	.0410	●	●
4,15	M5x0,9		66	24	17	36	0,8	6	.0415	●	●
4,20	M5 / M5x0,75	M4,5	66	24	17	36	0,8	6	.0420	●	●
4,30	MJ5x0,8	M4,5x0,5	66	24	17	36	0,8	6	.0430	●	●
4,35			66	24	17	36	0,8	6	.0435	●	●
4,40			66	24	17	36	0,9	6	.0440	●	●
4,45			66	24	17	36	0,9	6	.0445	●	●
4,50	M5x0,5		66	24	17	36	0,9	6	.0450	●	●
4,60	M5,5 / MJ5x0,5		66	24	17	36	0,9	6	.0460	●	●
4,65		M5	66	24	17	36	0,9	6	.0465	●	●
4,70		M5x0,75	66	24	17	36	0,9	6	.0470	●	●
4,80		M5x0,5	66	28	20	36	0,9	6	.0480	●	●
4,90			66	28	20	36	0,9	6	.0490	●	●
5,00	M6		66	28	20	36	1,0	6	.0500	●	●
5,10	MJ6x1	M5,5	66	28	20	36	1,0	6	.0510	●	●
5,20	M6x0,75		66	28	20	36	1,0	6	.0520	●	●
5,25			66	28	20	36	1,0	6	.0525	●	●
5,30		M5,5x0,5	66	28	20	36	1,0	6	.0530	●	●
5,40			66	28	20	36	1,0	6	.0540	●	●
5,50	M6x0,5		66	28	20	36	1,1	6	.0550	●	●
5,55		M6 (GAL)	66	28	20	36	1,1	6	.0555	●	●
5,60	MJ6x0,5	M6	66	28	20	36	1,1	6	.0560	●	●

VHM **TIALN T14**

DIN 6537 K **R30**

Z2 **4FF**

140° **IT9-IT10**

DIN 6535
HA HE

STEEL
Steel materials

- Product Finder
- vc / f
- STEEL**
- VA
- GG
- HCUT
- Zubehör Accessories
- Tech. Info

Kurze Ausführung
Short design

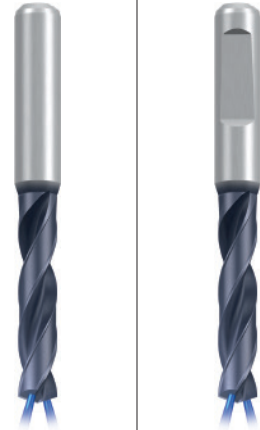
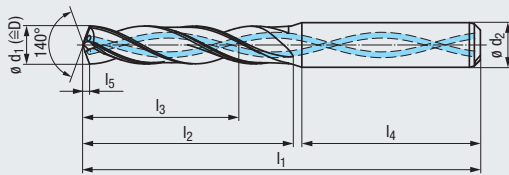

Bohrtiefe
Drill depth

3 x D

Einsatzgebiete – Material
Applications – material 510

P 1.1-5.1 **M** 1.1 **K** 1.1-4.2
N 1.1-5 **N** 2.1-8 **H** 1.1-2

Werkzeug-Ident · Tool ident

TA203344 TA503344

Ø d ₁ m7	Gewindebohrer Taps	Gewindeformer Cold-forming taps	l ₁	l ₂	l ₃	l ₄	l ₅	Ø d ₂ h6	Dimens.- Ident	EF-Drill-STEEL	
										DIN6537K-HA IK-4FF TIALN-T14	DIN6537K-HE IK-4FF TIALN-T14
5,70		M6x0,75	66	28	20	36	1,1	6	.0570	●	●
5,80		M6x0,5	66	28	20	36	1,1	6	.0580	●	●
5,90			66	28	20	36	1,1	6	.0590	●	●
6,00	M7		66	28	20	36	1,1	6	.0600	●	●
6,10	MJ7x1		79	34	24	36	1,2	8	.0610	●	●
6,20	M7x0,75		79	34	24	36	1,2	8	.0620	●	●
6,30			79	34	24	36	1,2	8	.0630	●	●
6,35	MJ7x0,75		79	34	24	36	1,2	8	.0635	●	●
6,40			79	34	24	36	1,2	8	.0640	●	●
6,50	M7x0,5		79	34	24	36	1,2	8	.0650	●	●
6,60		M7	79	34	24	36	1,3	8	.0660	●	●
6,70		M7x0,75	79	34	24	36	1,3	8	.0670	●	●
6,80	M8	M7x0,5	79	34	24	36	1,3	8	.0680	●	●
6,90	MJ8x1,25		79	34	24	36	1,3	8	.0690	●	●
7,00	M8x1		79	34	24	36	1,3	8	.0700	●	●
7,10	MJ8x1		79	41	29	36	1,3	8	.0710	●	●
7,20	M8x0,75		79	41	29	36	1,4	8	.0720	●	●
7,30			79	41	29	36	1,4	8	.0730	●	●
7,40		M8 (GAL)	79	41	29	36	1,4	8	.0740	●	●
7,45		M8	79	41	29	36	1,4	8	.0745	●	●
7,50	M8x0,5		79	41	29	36	1,4	8	.0750	●	●
7,60		M8x1	79	41	29	36	1,4	8	.0760	●	●
7,70		M8x0,75	79	41	29	36	1,5	8	.0770	●	●
7,80	M9	M8x0,5	79	41	29	36	1,5	8	.0780	●	●
7,90	MJ9x1,25		79	41	29	36	1,5	8	.0790	●	●
8,00	M9x1		79	41	29	36	1,5	8	.0800	●	●
8,10	MJ9x1		89	47	35	40	1,5	10	.0810	●	●
8,20	M9x0,75		89	47	35	40	1,5	10	.0820	●	●
8,30			89	47	35	40	1,6	10	.0830	●	●
8,40		M9 (GAL)	89	47	35	40	1,6	10	.0840	●	●
8,45		M9	89	47	35	40	1,6	10	.0845	●	●
8,50	M10 / M9x0,5		89	47	35	40	1,6	10	.0850	●	●
8,60	MJ10x1,5	M9x1	89	47	35	40	1,6	10	.0860	●	●
8,70		M9x0,75	89	47	35	40	1,6	10	.0870	●	●
8,80	M10x1,25	M9x0,5	89	47	35	40	1,7	10	.0880	●	●
8,90	MJ10x1,25		89	47	35	40	1,7	10	.0890	●	●
9,00	M10x1		89	47	35	40	1,7	10	.0900	●	●
9,10	MJ10x1		89	47	35	40	1,7	10	.0910	●	●
9,20	M10x0,75		89	47	35	40	1,7	10	.0920	●	●
9,30		M10 (GAL)	89	47	35	40	1,7	10	.0930	●	●
9,35	MJ10x0,75	M10	89	47	35	40	1,8	10	.0935	●	●
9,40		M10x1,25 (GAL)	89	47	35	40	1,8	10	.0940	●	●
9,45		M10x1,25	89	47	35	40	1,8	10	.0945	●	●

● = Lagerwerkzeug, siehe Preisliste · Stock tool, see price list
○ = Kurzfristig lieferbar, Preis auf Anfrage · Available on short notice, price upon inquiry

Ø 9,50 mm - Ø 20,00 mm



- Product Finder
- v_c / f
- STEEL
- VA
- GG
- HCUT
- Zubehör
Accessories
- Tech. Info

VHM

TIALN
T14

DIN
6537 K

R30

Z2

4FF

140°

IT9-IT10

DIN 6535

HA

HE

STEEL
Steel materials



Kurze Ausführung Short design

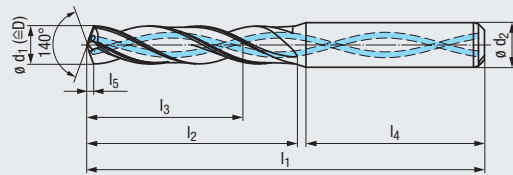

Bohrtiefe
Drill depth

3 x D

Einsatzgebiete – Material
Applications – material

P 1.1-5.1	M 1.1	K 1.1-4.2
N 1.1-5	N 2.1-8	H 1.1-2

Werkzeug-Ident · Tool ident

TA203344 TA503344

$\varnothing d_1$ m7	Gewindebohrer Taps	Gewindeformer Cold-forming taps						$\varnothing d_2$ h6	Dimens.- Ident	TA203344	TA503344
			l_1	l_2	l_3	l_4	l_5			EF-Drill-STEEL DIN6537K-HA IK-4FF TIALN-T14	EF-Drill-STEEL DIN6537K-HE IK-4FF TIALN-T14
9,50	M11 / M10x0,5		89	47	35	40	1,8	10	.0950	●	●
9,60	MJ10x0,5 / MJ11x1,5	M10x1	89	47	35	40	1,8	10	.0960	●	●
9,70		M10x0,75	89	47	35	40	1,8	10	.0970	●	●
9,80		M10x0,5	89	47	35	40	1,8	10	.0980	●	●
9,90	MJ11x1,25		89	47	35	40	1,9	10	.0990	●	●
10,00	M11x1		89	47	35	40	1,9	10	.1000	●	●
10,10	MJ11x1		102	55	40	45	1,9	12	.1010	●	●
10,20	M12 / M11x0,75		102	55	40	45	1,9	12	.1020	●	●
10,30		M11 (GAL)	102	55	40	45	1,9	12	.1030	●	●
10,35	MJ11x0,75	M11	102	55	40	45	1,9	12	.1035	●	●
10,40			102	55	40	45	1,9	12	.1040	●	●
10,50	M12x1,5		102	55	40	45	2,0	12	.1050	●	●
10,60	MJ12x1,5	M11x1	102	55	40	45	2,0	12	.1060	●	●
10,70		M11x0,75	102	55	40	45	2,0	12	.1070	●	●
10,80	M12x1,25		102	55	40	45	2,0	12	.1080	●	●
10,90	MJ12x1,25		102	55	40	45	2,0	12	.1090	●	●
11,00	M12x1		102	55	40	45	2,1	12	.1100	●	●
11,10	MJ12x1		102	55	40	45	2,1	12	.1110	●	●
11,20	M12x0,75	M12 (GAL)	102	55	40	45	2,1	12	.1120	●	●
11,25		M12	102	55	40	45	2,1	12	.1125	●	●
11,30		M12x1,5 (GAL)	102	55	40	45	2,1	12	.1130	●	●
11,35		M12x1,5	102	55	40	45	2,1	12	.1135	●	●
11,40		M12x1,25 (GAL)	102	55	40	45	2,1	12	.1140	●	●
11,45		M12x1,25	102	55	40	45	2,1	12	.1145	●	●
11,50			102	55	40	45	2,1	12	.1150	●	●
11,60		M12x1	102	55	40	45	2,2	12	.1160	●	●
11,70		M12x0,75	102	55	40	45	2,2	12	.1170	●	●
11,80			102	55	40	45	2,2	12	.1180	●	●
11,90			102	55	40	45	2,2	12	.1190	●	●
12,00	M14		102	55	40	45	2,2	12	.1200	●	●
12,20			107	60	43	45	2,3	14	.1220	●	●
12,30			107	60	43	45	2,3	14	.1230	●	●
12,50	M14x1,5		107	60	43	45	2,3	14	.1250	●	●
12,60	MJ14x1,5	M13x1	107	60	43	45	2,3	14	.1260	●	●
12,70		M13x0,75	107	60	43	45	2,4	14	.1270	●	●
12,80	M14x1,25		107	60	43	45	2,4	14	.1280	●	●
12,90	MJ14x1,25		107	60	43	45	2,4	14	.1290	●	●
13,00	M14x1		107	60	43	45	2,4	14	.1300	●	●
13,10	MJ14x1	M14	107	60	43	45	2,4	14	.1310	●	●
13,20	M14x0,75		107	60	43	45	2,5	14	.1320	●	●
13,30			107	60	43	45	2,5	14	.1330	●	●
13,35		M14x1,5	107	60	43	45	2,5	14	.1335	●	●
13,45		M14x1,25	107	60	43	45	2,5	14	.1345	●	●

Kurze Ausführung
Short design

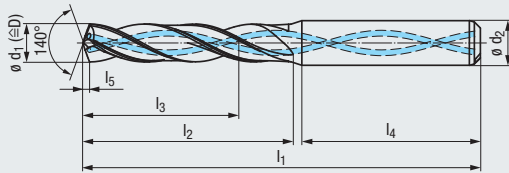

VHM **TIALN T14**

DIN 6537 K **R30**

Z2 **4FF**

140° **IT9-IT10**

DIN 6535
HA HE

STEEL
Steel materials

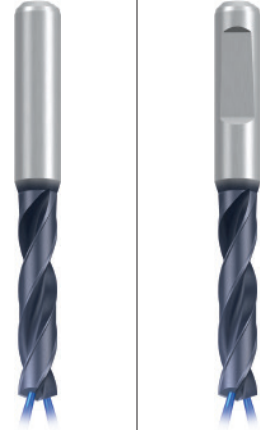

- Product Finder
- v_c / f
- STEEL**
- VA
- GG
- HCUT
- Zubehör Accessories
- Tech. Info

Bohrtiefe
Drill depth

3 x D

Einsatzgebiete – Material
Applications – material 510

P 1.1-5.1 **M** 1.1 **K** 1.1-4.2
N 1.1-5 **N** 2.1-8 **H** 1.1-2

Werkzeug-Ident · Tool ident

TA203344 TA503344

$\varnothing d_1$ m7	Gewindebohrer Taps	Gewindeformer Cold-forming taps						$\varnothing d_2$ h6	Dimens.- Ident		
			l_1	l_2	l_3	l_4	l_5			EF-Drill-STEEL DIN6537K-HA IK-4FF TIALN-T14	EF-Drill-STEEL DIN6537K-HE IK-4FF TIALN-T14
13,50			107	60	43	45	2,5	14	.1350	●	●
13,60	MJ15x1,5	M14x1	107	60	43	45	2,5	14	.1360	●	●
13,70		M14x0,75	107	60	43	45	2,5	14	.1370	●	●
13,80			107	60	43	45	2,6	14	.1380	●	●
14,00	M16 / M15x1		107	60	43	45	2,6	14	.1400	●	●
14,10	MJ15x1		115	65	45	48	2,6	16	.1410	●	●
14,30			115	65	45	48	2,7	16	.1430	●	●
14,40			115	65	45	48	2,7	16	.1440	●	●
14,50	M16x1,5		115	65	45	48	2,7	16	.1450	●	●
14,60	MJ16x1,5	M15x1	115	65	45	48	2,7	16	.1460	●	●
14,70		M15x0,75	115	65	45	48	2,7	16	.1470	●	●
14,80			115	65	45	48	2,7	16	.1480	●	●
15,00	M16x1		115	65	45	48	2,8	16	.1500	●	●
15,10	MJ16x1	M16	115	65	45	48	2,8	16	.1510	●	●
15,35		M16x1,5	115	65	45	48	2,8	16	.1535	●	●
15,50	M18		115	65	45	48	2,9	16	.1550	●	●
15,60		M16x1	115	65	45	48	2,9	16	.1560	●	●
16,00	M18x2		115	65	45	48	3,0	16	.1600	●	●
16,50	M18x1,5		123	73	51	48	3,1	18	.1650	●	●
17,00	M18x1		123	73	51	48	3,1	18	.1700	●	●
17,50	M20		123	73	51	48	3,2	18	.1750	●	●
17,60		M18x1	123	73	51	48	3,3	18	.1760	●	●
18,00	M20x2		123	73	51	48	3,3	18	.1800	●	●
18,50	M20x1,5		131	79	55	50	3,4	20	.1850	●	●
18,85		M20	131	79	55	50	3,5	20	.1885	●	●
19,00	M20x1		131	79	55	50	3,5	20	.1900	●	●
19,35		M20x1,5	131	79	55	50	3,6	20	.1935	●	●
19,50	M22		131	79	55	50	3,6	20	.1950	●	●
19,60		M20x1	131	79	55	50	3,6	20	.1960	●	●
20,00	M22x2		131	79	55	50	3,7	20	.2000	●	●

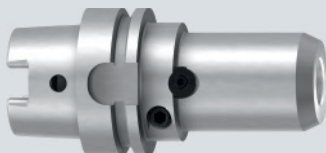

Hydrodehnspannfutter
siehe Seite 564 - 665

Hydraulic expansion chucks,
see page 564 - 665



- Product Finder
- v_c / f
- STEEL
- VA
- GG
- HCUT
- Zubehör Accessories
- Tech. Info

VHM **TIALN T14**

DIN 6537 L **R30**

Z2 **4FF**

140° **IT9-IT10**

DIN 6535
 HA  
 HE 

STEEL
Steel materials



Lange Ausführung
Long design

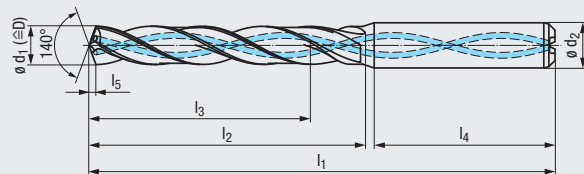

Bohrtiefe
Drill depth

5 x D

Einsatzgebiete – Material
Applications – material  510

P 1.1-5.1 **M** 1.1 **K** 1.1-4.2
N 1.1-5 **N** 2.1-8 **H** 1.1-2

Werkzeug-Ident · Tool ident

TA213344 **TA513344**

ϕd_1 m7	Gewindebohrer Taps	Gewindeformer Cold-forming taps						ϕd_2 h6	Dimens.- Ident	TA213344	TA513344
			l_1	l_2	l_3	l_4	l_5			EF-Drill-STEEL DIN6537L-HA IK-4FF TIALN-T14	EF-Drill-STEEL DIN6537L-HE IK-4FF TIALN-T14
2,80		M3	61	22	17	36	0,6	6	.0280	●	●
2,85			61	22	17	36	0,6	6	.0285	●	●
2,90	M3,5	M3x0,25	61	22	17	36	0,6	6	.0290	●	●
3,00	M3,5x0,5 / MJ3,5x0,6		66	28	23	36	0,6	6	.0300	●	●
3,10			66	28	23	36	0,6	6	.0310	●	●
3,15	M3,5x0,35		66	28	23	36	0,6	6	.0315	●	●
3,20	MJ3,5x0,35		66	28	23	36	0,6	6	.0320	●	●
3,25		M3,5	66	28	23	36	0,6	6	.0325	●	●
3,30	M4	M3,5x0,5	66	28	23	36	0,7	6	.0330	●	●
3,35			66	28	23	36	0,7	6	.0335	●	●
3,38		M3,5x0,35	66	28	23	36	0,7	6	.0338	●	●
3,40	MJ4x0,7		66	28	23	36	0,7	6	.0340	●	●
3,50	M4x0,5		66	28	23	36	0,7	6	.0350	●	●
3,55			66	28	23	36	0,7	6	.0355	●	●
3,60	MJ4x0,5		66	28	23	36	0,7	6	.0360	●	●
3,65	M4x0,35		66	28	23	36	0,7	6	.0365	●	●
3,70	M4,5	M4	66	28	23	36	0,7	6	.0370	●	●
3,80		M4x0,5	74	36	29	36	0,7	6	.0380	●	●
3,88		M4x0,35	74	36	29	36	0,8	6	.0388	●	●
3,90	MJ4,5x0,75		74	36	29	36	0,8	6	.0390	●	●
4,00			74	36	29	36	0,8	6	.0400	●	●
4,10	MJ4,5x0,5		74	36	29	36	0,8	6	.0410	●	●
4,15	M5x0,9		74	36	29	36	0,8	6	.0415	●	●
4,20	M5 / M5x0,75	M4,5	74	36	29	36	0,8	6	.0420	●	●
4,30	MJ5x0,8	M4,5x0,5	74	36	29	36	0,8	6	.0430	●	●
4,35			74	36	29	36	0,8	6	.0435	●	●
4,40			74	36	29	36	0,9	6	.0440	●	●
4,45			74	36	29	36	0,9	6	.0445	●	●
4,50	M5x0,5		74	36	29	36	0,9	6	.0450	●	●
4,60	M5,5 / MJ5x0,5		74	36	29	36	0,9	6	.0460	●	●
4,65		M5	74	36	29	36	0,9	6	.0465	●	●
4,70		M5x0,75	74	36	29	36	0,9	6	.0470	●	●
4,80		M5x0,5	82	44	35	36	0,9	6	.0480	●	●
4,90			82	44	35	36	0,9	6	.0490	●	●
5,00	M6		82	44	35	36	1,0	6	.0500	●	●
5,10	MJ6x1	M5,5	82	44	35	36	1,0	6	.0510	●	●
5,20	M6x0,75		82	44	35	36	1,0	6	.0520	●	●
5,25			82	44	35	36	1,0	6	.0525	●	●
5,30		M5,5x0,5	82	44	35	36	1,0	6	.0530	●	●
5,40			82	44	35	36	1,0	6	.0540	●	●
5,50	M6x0,5		82	44	35	36	1,1	6	.0550	●	●
5,55		M6 (GAL)	82	44	35	36	1,1	6	.0555	●	●
5,60	MJ6x0,5	M6	82	44	35	36	1,1	6	.0560	●	●

VHM **TIALN T14**

DIN 6537 L **R30**

Z2 **4FF**

140° **IT9-IT10**

DIN 6535
HA HE

STEEL
Steel materials

- Product Finder
- v_c / f
- STEEL**
- VA
- GG
- HCUT
- Zubehör Accessories
- Tech. Info

Lange Ausführung
Long design

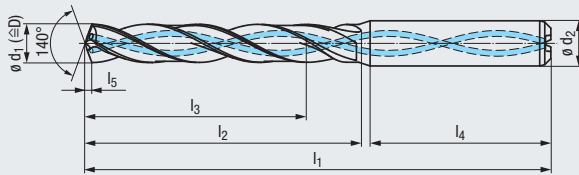

Bohrtiefe
Drill depth

5 x D

Einsatzgebiete – Material
Applications – material 510

P 1.1-5.1 **M** 1.1 **K** 1.1-4.2
N 1.1-5 **N** 2.1-8 **H** 1.1-2

Werkzeug-Ident · Tool ident

TA213344 TA513344

ø d ₁ m7	Gewindebohrer Taps	Gewindeformer Cold-forming taps	l ₁	l ₂	l ₃	l ₄	l ₅	ø d ₂ h6	Dimens.- Ident	EF-Drill-STEEL	
										DIN6537L-HA IK-4FF TIALN-T14	DIN6537L-HE IK-4FF TIALN-T14
5,70		M6x0,75	82	44	35	36	1,1	6	.0570	●	●
5,80		M6x0,5	82	44	35	36	1,1	6	.0580	●	●
5,90			82	44	35	36	1,1	6	.0590	●	●
6,00	M7		82	44	35	36	1,1	6	.0600	●	●
6,10	MJ7x1		91	53	43	36	1,2	8	.0610	●	●
6,20	M7x0,75		91	53	43	36	1,2	8	.0620	●	●
6,30			91	53	43	36	1,2	8	.0630	●	●
6,35	MJ7x0,75		91	53	43	36	1,2	8	.0635	●	●
6,40			91	53	43	36	1,2	8	.0640	●	●
6,50	M7x0,5		91	53	43	36	1,2	8	.0650	●	●
6,60		M7	91	53	43	36	1,3	8	.0660	●	●
6,70		M7x0,75	91	53	43	36	1,3	8	.0670	●	●
6,80	M8	M7x0,5	91	53	43	36	1,3	8	.0680	●	●
6,90	MJ8x1,25		91	53	43	36	1,3	8	.0690	●	●
7,00	M8x1		91	53	43	36	1,3	8	.0700	●	●
7,10	MJ8x1		91	53	43	36	1,3	8	.0710	●	●
7,20	M8x0,75		91	53	43	36	1,4	8	.0720	●	●
7,30			91	53	43	36	1,4	8	.0730	●	●
7,40		M8 (GAL)	91	53	43	36	1,4	8	.0740	●	●
7,45		M8	91	53	43	36	1,4	8	.0745	●	●
7,50	M8x0,5		91	53	43	36	1,4	8	.0750	●	●
7,60		M8x1	91	53	43	36	1,4	8	.0760	●	●
7,70		M8x0,75	91	53	43	36	1,5	8	.0770	●	●
7,80	M9	M8x0,5	91	53	43	36	1,5	8	.0780	●	●
7,90	MJ9x1,25		91	53	43	36	1,5	8	.0790	●	●
8,00	M9x1		91	53	43	36	1,5	8	.0800	●	●
8,10	MJ9x1		103	61	49	40	1,5	10	.0810	●	●
8,20	M9x0,75		103	61	49	40	1,5	10	.0820	●	●
8,30			103	61	49	40	1,6	10	.0830	●	●
8,40		M9 (GAL)	103	61	49	40	1,6	10	.0840	●	●
8,45		M9	103	61	49	40	1,6	10	.0845	●	●
8,50	M10 / M9x0,5		103	61	49	40	1,6	10	.0850	●	●
8,60	MJ10x1,5	M9x1	103	61	49	40	1,6	10	.0860	●	●
8,70		M9x0,75	103	61	49	40	1,6	10	.0870	●	●
8,80	M10x1,25	M9x0,5	103	61	49	40	1,7	10	.0880	●	●
8,90	MJ10x1,25		103	61	49	40	1,7	10	.0890	●	●
9,00	M10x1		103	61	49	40	1,7	10	.0900	●	●
9,10	MJ10x1		103	61	49	40	1,7	10	.0910	●	●
9,20	M10x0,75		103	61	49	40	1,7	10	.0920	●	●
9,30		M10 (GAL)	103	61	49	40	1,7	10	.0930	●	●
9,35	MJ10x0,75	M10	103	61	49	40	1,8	10	.0935	●	●
9,40		M10x1,25 (GAL)	103	61	49	40	1,8	10	.0940	●	●
9,45		M10x1,25	103	61	49	40	1,8	10	.0945	●	●

● = Lagerwerkzeug, siehe Preisliste · Stock tool, see price list
○ = Kurzfristig lieferbar, Preis auf Anfrage · Available on short notice, price upon inquiry

ø 9,50 mm - ø 20,00 mm

- Product Finder
- v_c / f
- STEEL
- VA
- GG
- HCUT
- Zubehör
Accessories
- Tech. Info

VHM

TIALN
T14

DIN
6537 L

R30

Z2

4FF

140°

IT9-IT10

DIN 6535

HA

HE

STEEL
Steel
materials



Lange Ausführung
Long design

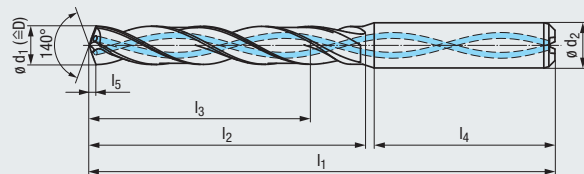

Bohrtiefe
Drill depth

5 x D

Einsatzgebiete – Material
Applications – material



P 1.1-5.1	M 1.1	K 1.1-4.2
N 1.1-5	N 2.1-8	H 1.1-2

Werkzeug-Ident · Tool ident

TA213344 TA513344

ϕd_1 m7	Gewindebohrer Taps	Gewindeformer Cold-forming taps						ϕd_2 h6	Dimens.- Ident	TA213344	TA513344
			l_1	l_2	l_3	l_4	l_5			EF-Drill-STEEL DIN6537L-HA IK-4FF TIALN-T14	EF-Drill-STEEL DIN6537L-HE IK-4FF TIALN-T14
9,50	M11 / M10x0,5		103	61	49	40	1,8	10	.0950	●	●
9,60	MJ10x0,5 / MJ11x1,5	M10x1	103	61	49	40	1,8	10	.0960	●	●
9,70		M10x0,75	103	61	49	40	1,8	10	.0970	●	●
9,80		M10x0,5	103	61	49	40	1,8	10	.0980	●	●
9,90	MJ11x1,25		103	61	49	40	1,9	10	.0990	●	●
10,00	M11x1		103	61	49	40	1,9	10	.1000	●	●
10,10	MJ11x1		118	71	56	45	1,9	12	.1010	●	●
10,20	M12 / M11x0,75		118	71	56	45	1,9	12	.1020	●	●
10,30		M11 (GAL)	118	71	56	45	1,9	12	.1030	●	●
10,35	MJ11x0,75	M11	118	71	56	45	1,9	12	.1035	●	●
10,40			118	71	56	45	1,9	12	.1040	●	●
10,50	M12x1,5		118	71	56	45	2,0	12	.1050	●	●
10,60	MJ12x1,5	M11x1	118	71	56	45	2,0	12	.1060	●	●
10,70		M11x0,75	118	71	56	45	2,0	12	.1070	●	●
10,80	M12x1,25		118	71	56	45	2,0	12	.1080	●	●
10,90	MJ12x1,25		118	71	56	45	2,0	12	.1090	●	●
11,00	M12x1		118	71	56	45	2,1	12	.1100	●	●
11,10	MJ12x1		118	71	56	45	2,1	12	.1110	●	●
11,20	M12x0,75	M12 (GAL)	118	71	56	45	2,1	12	.1120	●	●
11,25		M12	118	71	56	45	2,1	12	.1125	●	●
11,30		M12x1,5 (GAL)	118	71	56	45	2,1	12	.1130	●	●
11,35		M12x1,5	118	71	56	45	2,1	12	.1135	●	●
11,40		M12x1,25 (GAL)	118	71	56	45	2,1	12	.1140	●	●
11,45		M12x1,25	118	71	56	45	2,1	12	.1145	●	●
11,50			118	71	56	45	2,1	12	.1150	●	●
11,60		M12x1	118	71	56	45	2,2	12	.1160	●	●
11,70		M12x0,75	118	71	56	45	2,2	12	.1170	●	●
11,80			118	71	56	45	2,2	12	.1180	●	●
11,90			118	71	56	45	2,2	12	.1190	●	●
12,00	M14		118	71	56	45	2,2	12	.1200	●	●
12,20			124	77	60	45	2,3	14	.1220	●	●
12,30			124	77	60	45	2,3	14	.1230	●	●
12,50	M14x1,5		124	77	60	45	2,3	14	.1250	●	●
12,60	MJ14x1,5	M13x1	124	77	60	45	2,3	14	.1260	●	●
12,70		M13x0,75	124	77	60	45	2,4	14	.1270	●	●
12,80	M14x1,25		124	77	60	45	2,4	14	.1280	●	●
12,90	MJ14x1,25		124	77	60	45	2,4	14	.1290	●	●
13,00	M14x1		124	77	60	45	2,4	14	.1300	●	●
13,10	MJ14x1	M14	124	77	60	45	2,4	14	.1310	●	●
13,20	M14x0,75		124	77	60	45	2,5	14	.1320	●	●
13,30			124	77	60	45	2,5	14	.1330	●	●
13,35		M14x1,5	124	77	60	45	2,5	14	.1335	●	●
13,45		M14x1,25	124	77	60	45	2,5	14	.1345	●	●

VHM **TIALN T14**

DIN 6537 L **R30**

Z2 **4FF**

140° **IT9-IT10**

DIN 6535
HA HE

STEEL
Steel materials

- Product Finder
- v_c / f
- STEEL**
- VA
- GG
- HCUT
- Zubehör Accessories
- Tech. Info

Lange Ausführung
Long design

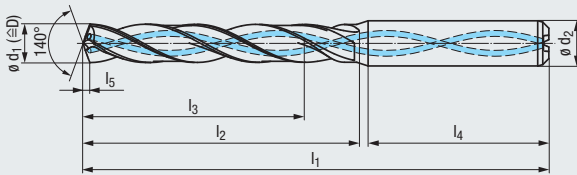

Bohrtiefe
Drill depth

5 x D

Einsatzgebiete – Material
Applications – material 510

P 1.1-5.1 **M** 1.1 **K** 1.1-4.2
N 1.1-5 **N** 2.1-8 **H** 1.1-2

Werkzeug-Ident · Tool ident

TA213344 TA513344

ø d ₁ m7	Gewindebohrer Taps	Gewindeformer Cold-forming taps						ø d ₂ h6	Dimens.- Ident	EF-Drill-STEEL	
			l ₁	l ₂	l ₃	l ₄	l ₅			DIN6537L-HA IK-4FF TIALN-T14	DIN6537L-HE IK-4FF TIALN-T14
13,50			124	77	60	45	2,5	14	.1350	●	●
13,60	MJ15x1,5	M14x1	124	77	60	45	2,5	14	.1360	●	●
13,70		M14x0,75	124	77	60	45	2,5	14	.1370	●	●
13,80			124	77	60	45	2,6	14	.1380	●	●
14,00	M16 / M15x1		124	77	60	45	2,6	14	.1400	●	●
14,10	MJ15x1		133	83	63	48	2,6	16	.1410	●	●
14,30			133	83	63	48	2,7	16	.1430	●	●
14,40			133	83	63	48	2,7	16	.1440	●	●
14,50	M16x1,5		133	83	63	48	2,7	16	.1450	●	●
14,60	MJ16x1,5	M15x1	133	83	63	48	2,7	16	.1460	●	●
14,70		M15x0,75	133	83	63	48	2,7	16	.1470	●	●
14,80			133	83	63	48	2,7	16	.1480	●	●
15,00	M16x1		133	83	63	48	2,8	16	.1500	●	●
15,10	MJ16x1	M16	133	83	63	48	2,8	16	.1510	●	●
15,35		M16x1,5	133	83	63	48	2,8	16	.1535	●	●
15,50	M18		133	83	63	48	2,9	16	.1550	●	●
15,60		M16x1	133	83	63	48	2,9	16	.1560	●	●
16,00	M18x2		133	83	63	48	3,0	16	.1600	●	●
16,50	M18x1,5		143	93	71	48	3,1	18	.1650	●	●
17,00	M18x1		143	93	71	48	3,1	18	.1700	●	●
17,50	M20		143	93	71	48	3,2	18	.1750	●	●
17,60		M18x1	143	93	71	48	3,3	18	.1760	●	●
18,00	M20x2		143	93	71	48	3,3	18	.1800	●	●
18,50	M20x1,5		153	101	77	50	3,4	20	.1850	●	●
18,85		M20	153	101	77	50	3,5	20	.1885	●	●
19,00	M20x1		153	101	77	50	3,5	20	.1900	●	●
19,35		M20x1,5	153	101	77	50	3,6	20	.1935	●	●
19,50	M22		153	101	77	50	3,6	20	.1950	●	●
19,60		M20x1	153	101	77	50	3,6	20	.1960	●	●
20,00	M22x2		153	101	77	50	3,7	20	.2000	●	●

- 3 x D
- 5 x D**
- 6 x D
- 8 x D
- 2-3,5 x D



- Product Finder
- v_c / f
- STEEL
- VA
- GG
- HCUT
- Zubehör Accessories
- Tech. Info

VHM

TIALN T14

R30

Z2

4FF

135°

IT9-IT11

DIN 6535

HA

STEEL
Steel materials



Extra-lange Ausführung
Extra long design

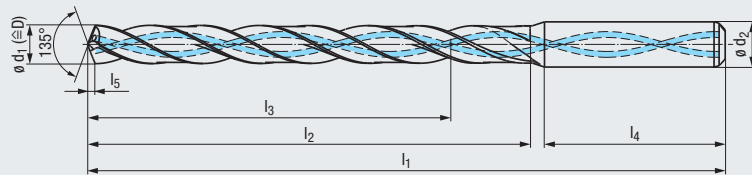

Eine Vorzentrierung durch den Einsatz eines Vorbohrers (z.B. EF-Drill nach DIN 6537 K) wird empfohlen
Preparatory centering with a centering drill (p.ex. EF-Drill acc. DIN 6537 K) is recommended

Bohrtiefe
Drill depth

8 x D

Einsatzgebiete – Material
Applications – material

P 1.1-5.1 M 1.1 K 1.1-4.2
N 1.1-5 N 2.1-8

Werkzeug-Ident · Tool ident

TA223344

$\emptyset d_1$ m7	Gewindebohrer Taps	Gewindeformer Cold-forming taps						$\emptyset d_2$ h6	Dimens.- Ident	EF-Drill-STEEL 8xD-HA IK-4FF TIALN-T14
			l_1	l_2	l_3	l_4	l_5			
2,80		M3	70	30	24	36	0,6	6	.0280	●
2,85			70	30	24	36	0,6	6	.0285	●
2,90	M3,5	M3x0,25	70	30	24	36	0,7	6	.0290	●
3,00	M3,5x0,5 / MJ3,5x0,6		78	38	30	36	0,7	6	.0300	●
3,10			78	38	30	36	0,7	6	.0310	●
3,15	M3,5x0,35		78	38	30	36	0,7	6	.0315	●
3,20	MJ3,5x0,35		78	38	30	36	0,7	6	.0320	●
3,25		M3,5	78	38	30	36	0,7	6	.0325	●
3,30	M4	M3,5x0,5	78	38	30	36	0,7	6	.0330	●
3,35			78	38	30	36	0,7	6	.0335	●
3,38		M3,5x0,35	78	38	30	36	0,8	6	.0338	●
3,40	MJ4x0,7		78	38	30	36	0,8	6	.0340	●
3,50	M4x0,5		78	38	30	36	0,8	6	.0350	●
3,55			78	38	30	36	0,8	6	.0355	●
3,60	MJ4x0,5		78	38	30	36	0,8	6	.0360	●
3,65	M4x0,35		78	38	30	36	0,8	6	.0365	●
3,70	M4,5	M4	78	38	30	36	0,8	6	.0370	●
3,80		M4x0,5	88	48	38	36	0,8	6	.0380	●
3,88		M4x0,35	88	48	38	36	0,9	6	.0388	●
3,90	MJ4,5x0,75		88	48	38	36	0,9	6	.0390	●
4,00			88	48	38	36	0,9	6	.0400	●
4,10	MJ4,5x0,5		88	48	38	36	0,9	6	.0410	●
4,15	M5x0,9		88	48	38	36	0,9	6	.0415	●
4,20	M5 / M5x0,75	M4,5	88	48	38	36	0,9	6	.0420	●
4,30	MJ5x0,8	M4,5x0,5	88	48	38	36	0,9	6	.0430	●
4,35			88	48	38	36	1,0	6	.0435	●
4,40			88	48	38	36	1,0	6	.0440	●
4,45			88	48	38	36	1,0	6	.0445	●
4,50	M5x0,5		88	48	38	36	1,0	6	.0450	●
4,60	M5,5 / MJ5x0,5		88	48	38	36	1,0	6	.0460	●
4,65		M5	88	48	38	36	1,0	6	.0465	●
4,70		M5x0,75	88	48	38	36	1,0	6	.0470	●
4,80		M5x0,5	97	60	48	36	1,0	6	.0480	●
4,90			97	60	48	36	1,1	6	.0490	●
5,00	M6		97	60	48	36	1,1	6	.0500	●
5,10	MJ6x1	M5,5	97	60	48	36	1,1	6	.0510	●
5,20	M6x0,75		97	60	48	36	1,1	6	.0520	●
5,25			97	60	48	36	1,1	6	.0525	●
5,30		M5,5x0,5	97	60	48	36	1,1	6	.0530	●
5,40			97	60	48	36	1,2	6	.0540	●
5,50	M6x0,5		97	60	48	36	1,2	6	.0550	●
5,55		M6 (GAL)	97	60	48	36	1,2	6	.0555	●
5,60	MJ6x0,5	M6	97	60	48	36	1,2	6	.0560	●

VHM TIALN T14
R30
Z2 4FF
135° IT9-IT11
DIN 6535
HA

STEEL
Steel
materials



Extra-lange Ausführung
Extra long design

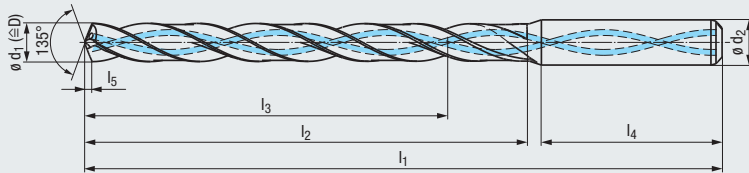

Eine Vorzentrierung durch den Einsatz eines Vorbohrers (z.B. EF-Drill nach DIN 6537 K) wird empfohlen
Preparatory centering with a centering drill (p.ex. EF-Drill acc. DIN 6537 K) is recommended

Bohrtiefe
Drill depth

8 x D

Einsatzgebiete – Material
Applications – material

P 1.1-5.1 M 1.1 K 1.1-4.2
N 1.1-5 N 2.1-8

Werkzeug-Ident · Tool ident

TA223344

$\varnothing d_1$ m7	Gewindebohrer Taps	Gewindeformer Cold-forming taps						$\varnothing d_2$ h6	Dimens.- Ident	EF-Drill-STEEL 8xD-HA IK-4FF TIALN-T14
			l_1	l_2	l_3	l_4	l_5			
5,70		M6x0,75	97	60	48	36	1,2	6	.0570	●
5,80		M6x0,5	97	60	48	36	1,3	6	.0580	●
5,90			97	60	48	36	1,3	6	.0590	●
6,00	M7		97	60	48	36	1,3	6	.0600	●
6,10	MJ7x1		107	70	56	36	1,3	8	.0610	●
6,20	M7x0,75		107	70	56	36	1,3	8	.0620	●
6,30			107	70	56	36	1,4	8	.0630	●
6,35	MJ7x0,75		107	70	56	36	1,4	8	.0635	●
6,40			107	70	56	36	1,4	8	.0640	●
6,50	M7x0,5		107	70	56	36	1,4	8	.0650	●
6,60		M7	107	70	56	36	1,4	8	.0660	●
6,70		M7x0,75	107	70	56	36	1,4	8	.0670	●
6,80	M8	M7x0,5	107	70	56	36	1,5	8	.0680	●
6,90	MJ8x1,25		107	70	56	36	1,5	8	.0690	●
7,00	M8x1		107	70	56	36	1,5	8	.0700	●
7,10	MJ8x1		117	80	64	36	1,5	8	.0710	●
7,20	M8x0,75		117	80	64	36	1,5	8	.0720	●
7,30			117	80	64	36	1,6	8	.0730	●
7,40		M8 (GAL)	117	80	64	36	1,6	8	.0740	●
7,45		M8	117	80	64	36	1,6	8	.0745	●
7,50	M8x0,5		117	80	64	36	1,6	8	.0750	●
7,60		M8x1	117	80	64	36	1,6	8	.0760	●
7,70		M8x0,75	117	80	64	36	1,6	8	.0770	●
7,80	M9	M8x0,5	117	80	64	36	1,7	8	.0780	●
7,90	MJ9x1,25		117	80	64	36	1,7	8	.0790	●
8,00	M9x1		117	80	64	36	1,7	8	.0800	●
8,10	MJ9x1		141	100	80	40	1,7	10	.0810	●
8,20	M9x0,75		141	100	80	40	1,7	10	.0820	●
8,30			141	100	80	40	1,8	10	.0830	●
8,40		M9 (GAL)	141	100	80	40	1,8	10	.0840	●
8,45		M9	141	100	80	40	1,8	10	.0845	●
8,50	M10 / M9x0,5		141	100	80	40	1,8	10	.0850	●
8,60	MJ10x1,5	M9x1	141	100	80	40	1,8	10	.0860	●
8,70		M9x0,75	141	100	80	40	1,9	10	.0870	●
8,80	M10x1,25	M9x0,5	141	100	80	40	1,9	10	.0880	●
8,90	MJ10x1,25		141	100	80	40	1,9	10	.0890	●
9,00	M10x1		141	100	80	40	1,9	10	.0900	●
9,10	MJ10x1		141	100	80	40	1,9	10	.0910	●
9,20	M10x0,75		141	100	80	40	2,0	10	.0920	●
9,30		M10 (GAL)	141	100	80	40	2,0	10	.0930	●
9,35	MJ10x0,75	M10	141	100	80	40	2,0	10	.0935	●
9,40		M10x1,25 (GAL)	141	100	80	40	2,0	10	.0940	●
9,45		M10x1,25	141	100	80	40	2,0	10	.0945	●

● = Lagerwerkzeug, siehe Preisliste · Stock tool, see price list
○ = Kurzfristig lieferbar, Preis auf Anfrage · Available on short notice, price upon inquiry

Product
Finder
v_c / f
STEEL
VA
GG
HCUT
Zubehör
Accessories
Tech. Info

3 x D
5 x D
6 x D
8 x D
2-3,5 x D



- Product Finder
- v_c / f
- STEEL
- VA
- GG
- HCUT
- Zubehör Accessories
- Tech. Info

VHM TIALN T14

R30

Z2 4FF

135° IT9-IT11

DIN 6535 HA

STEEL
Steel materials



Extra-lange Ausführung
Extra long design

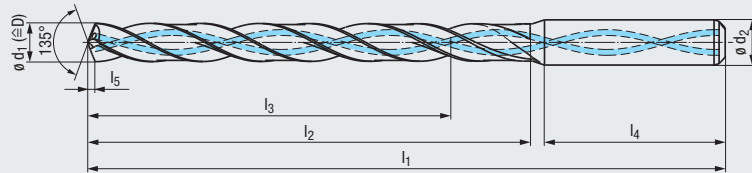

Eine Vorzentrierung durch den Einsatz eines Vorbohrers (z.B. EF-Drill nach DIN 6537 K) wird empfohlen
Preparatory centering with a centering drill (p.ex. EF-Drill acc. DIN 6537 K) is recommended

Bohrtiefe
Drill depth

8 x D

Einsatzgebiete – Material
Applications – material

P 1.1-5.1 M 1.1 K 1.1-4.2
N 1.1-5 N 2.1-8

Werkzeug-Ident · Tool ident

TA223344

$\emptyset d_1$ m7	Gewindebohrer Taps	Gewindeformer Cold-forming taps	Dimensions					$\emptyset d_2$ h6	Dimens.- Ident	EF-Drill-STEEL 8xD-HA IK-4FF TIALN-T14
			l_1	l_2	l_3	l_4	l_5			
9,50	M11 / M10x0,5		141	100	80	40	2,0	10	.0950	●
9,60	MJ10x0,5 / MJ11x1,5	M10x1	141	100	80	40	2,0	10	.0960	●
9,70		M10x0,75	141	100	80	40	2,1	10	.0970	●
9,80		M10x0,5	141	100	80	40	2,1	10	.0980	●
9,90	MJ11x1,25		141	100	80	40	2,1	10	.0990	●
10,00	M11x1		141	100	80	40	2,1	10	.1000	●
10,10	MJ11x1		166	120	96	45	2,1	12	.1010	●
10,20	M12 / M11x0,75		166	120	96	45	2,2	12	.1020	●
10,30		M11 (GAL)	166	120	96	45	2,2	12	.1030	●
10,35	MJ11x0,75	M11	166	120	96	45	2,2	12	.1035	●
10,40			166	120	96	45	2,2	12	.1040	●
10,50	M12x1,5		166	120	96	45	2,2	12	.1050	●
10,60	MJ12x1,5	M11x1	166	120	96	45	2,2	12	.1060	●
10,70		M11x0,75	166	120	96	45	2,3	12	.1070	●
10,80	M12x1,25		166	120	96	45	2,3	12	.1080	●
10,90	MJ12x1,25		166	120	96	45	2,3	12	.1090	●
11,00	M12x1		166	120	96	45	2,3	12	.1100	●
11,10	MJ12x1		166	120	96	45	2,3	12	.1110	●
11,20	M12x0,75	M12 (GAL)	166	120	96	45	2,4	12	.1120	●
11,25		M12	166	120	96	45	2,4	12	.1125	●
11,30		M12x1,5 (GAL)	166	120	96	45	2,4	12	.1130	●
11,35		M12x1,5	166	120	96	45	2,4	12	.1135	●
11,40		M12x1,25 (GAL)	166	120	96	45	2,4	12	.1140	●
11,45		M12x1,25	166	120	96	45	2,4	12	.1145	●
11,50			166	120	96	45	2,4	12	.1150	●
11,60		M12x1	166	120	96	45	2,5	12	.1160	●
11,70		M12x0,75	166	120	96	45	2,5	12	.1170	●
11,80			166	120	96	45	2,5	12	.1180	●
11,90			166	120	96	45	2,5	12	.1190	●
12,00	M14		166	120	96	45	2,5	12	.1200	●
12,20			186	140	112	45	2,6	14	.1220	●
12,30			186	140	112	45	2,6	14	.1230	●
12,50	M14x1,5		186	140	112	45	2,6	14	.1250	●
12,60	MJ14x1,5	M13x1	186	140	112	45	2,7	14	.1260	●
12,70		M13x0,75	186	140	112	45	2,7	14	.1270	●
12,80	M14x1,25		186	140	112	45	2,7	14	.1280	●
12,90	MJ14x1,25		186	140	112	45	2,7	14	.1290	●
13,00	M14x1		186	140	112	45	2,7	14	.1300	●
13,10	MJ14x1	M14	186	140	112	45	2,8	14	.1310	●
13,20	M14x0,75		186	140	112	45	2,8	14	.1320	●
13,30			186	140	112	45	2,8	14	.1330	●
13,35		M14x1,5	186	140	112	45	2,8	14	.1335	●
13,45		M14x1,25	186	140	112	45	2,8	14	.1345	●

VHM TIALN T14

R30

Z2 4FF

135° IT9-IT11

DIN 6535 HA

STEEL
Steel materials



Extra-lange Ausführung
Extra long design

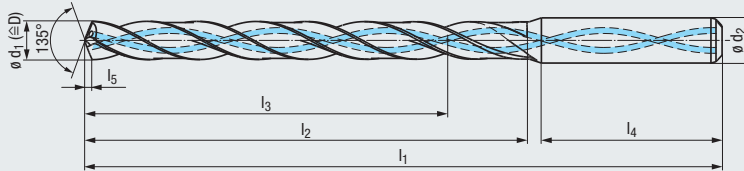

Eine Vorzentrierung durch den Einsatz eines Vorbohrers (z.B. EF-Drill nach DIN 6537 K) wird empfohlen
Preparatory centering with a centering drill (p.ex. EF-Drill acc. DIN 6537 K) is recommended

Bohrtiefe
Drill depth

8 x D

Einsatzgebiete – Material
Applications – material

P 1.1-5.1 M 1.1 K 1.1-4.2
N 1.1-5 N 2.1-8

Werkzeug-Ident · Tool ident

TA223344

ø d ₁ m7	Gewindebohrer Taps	Gewindeformer Cold-forming taps						ø d ₂ h6	Dimens.- Ident	EF-Drill-STEEL 8xD-HA IK-4FF TIALN-T14
			l ₁	l ₂	l ₃	l ₄	l ₅			
13,50			186	140	112	45	2,8	14	.1350	●
13,60	MJ15x1,5	M14x1	186	140	112	45	2,9	14	.1360	●
13,70		M14x0,75	186	140	112	45	2,9	14	.1370	●
13,80			186	140	112	45	2,9	14	.1380	●
14,00	M16 / M15x1		186	140	112	45	2,9	14	.1400	●
14,10	MJ15x1		209	160	128	48	3,0	16	.1410	●
14,30			209	160	128	48	3,0	16	.1430	●
14,40			209	160	128	48	3,0	16	.1440	●
14,50	M16x1,5		209	160	128	48	3,1	16	.1450	●
14,60	MJ16x1,5	M15x1	209	160	128	48	3,1	16	.1460	●
14,70		M15x0,75	209	160	128	48	3,1	16	.1470	●
14,80			209	160	128	48	3,1	16	.1480	●
15,00	M16x1		209	160	128	48	3,2	16	.1500	●
15,10	MJ16x1	M16	209	160	128	48	3,2	16	.1510	●
15,35		M16x1,5	209	160	128	48	3,2	16	.1535	●
15,50	M18		209	160	128	48	3,3	16	.1550	●
15,60		M16x1	209	160	128	48	3,3	16	.1560	●
16,00	M18x2		209	160	128	48	3,4	16	.1600	●
16,50	M18x1,5		229	180	144	48	3,5	18	.1650	●
17,00	M18x1		229	180	144	48	3,6	18	.1700	●
17,50	M20		229	180	144	48	3,7	18	.1750	●
17,60		M18x1	229	180	144	48	3,7	18	.1760	●
18,00	M20x2		229	180	144	48	3,8	18	.1800	●
18,50	M20x1,5		251	200	160	50	3,9	20	.1850	●
18,85		M20	251	200	160	50	4,0	20	.1885	●
19,00	M20x1		251	200	160	50	4,0	20	.1900	●
19,35		M20x1,5	251	200	160	50	4,1	20	.1935	●
19,50	M22		251	200	160	50	4,1	20	.1950	●
19,60		M20x1	251	200	160	50	4,1	20	.1960	●
20,00	M22x2		251	200	160	50	4,2	20	.2000	●



Kühlschmierstoffe siehe Seite 238 - 239

Coolant-lubricants, see page 238 - 239

- Product Finder
- v_c / f
- STEEL
- VA
- GG
- HCUT
- Zubehör Accessories
- Tech. Info

VHM

TIALN T21

new

R30



Vollhartmetall-Schneidkopf
Solid carbide cutting head

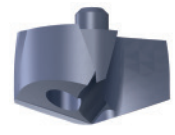
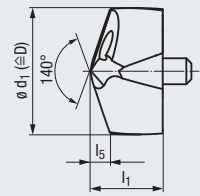

STEEL
Steel materials

Einsatzgebiete – Material
Applications – material

» 510

P 1.1-5.1 M 1.1
K 1.1-4.2 N 1.4-5

Werkzeug-Ident · Tool ident

TM003324

- 3 x D
- 5 x D
- 6 x D
- 8 x D
- 2-3,5 x D

$\varnothing d_1$ k8	Gewindebohrer Taps	Gewindeformer Cold-forming taps	Plattensitzgröße Size of insert seat	l_1	l_5	Dimens.- Ident	EF-Drill Modular STEEL AK-2FF TIALN-T21
14,00	M16 / M15x1		2	8	2,6	.1400	●
14,10	MJ15x1		2	8	2,6	.1410	●
14,20	M15x0,75		2	8	2,6	.1420	●
14,30			2	8	2,7	.1430	●
14,40			2	8	2,7	.1440	●
14,50	M16x1,5		2	8	2,7	.1450	●
14,60	MJ16x1,5	M15x1	2	8	2,7	.1460	●
14,70		M15x0,75	2	8	2,7	.1470	●
14,80			2	8	2,7	.1480	●
14,90			2	8	2,8	.1490	●
15,00	M16x1		2	8	2,8	.1500	●
15,10	MJ16x1	M16	2	8	2,8	.1510	●
15,20	M16x0,75		2	8	2,8	.1520	●
15,30			2	8	2,8	.1530	●
15,35		M16x1,5	2	8	2,8	.1535	●
15,40			2	8	2,9	.1540	●
15,50	M18		2	8	2,9	.1550	●
15,60		M16x1	2	8	2,9	.1560	●
15,70		M16x0,75	2	8	2,9	.1570	●
15,80	MJ18x2,5		2	8	2,9	.1580	●
15,90			2	8	2,9	.1590	●
16,00	M18x2		3	9	3,0	.1600	●
16,10	MJ17x1		3	9	3,0	.1610	●
16,20			3	9	3,0	.1620	●
16,30			3	9	3,0	.1630	●
16,40			3	9	3,0	.1640	●
16,50	M18x1,5		3	9	3,1	.1650	●
16,60	MJ18x1,5		3	9	3,1	.1660	●
16,70			3	9	3,1	.1670	●
16,80			3	9	3,1	.1680	●
16,85		M18	3	9	3,1	.1685	●
16,90			3	9	3,1	.1690	●
17,00	M18x1		3	9	3,1	.1700	●
17,10	MJ18x1	M18x2	3	9	3,2	.1710	●
17,20			3	9	3,2	.1720	●
17,30			3	9	3,2	.1730	●
17,35		M18x1,5	3	9	3,2	.1735	●
17,40			3	9	3,2	.1740	●
17,50	M20		3	9	3,2	.1750	●
17,60		M18x1	3	9	3,3	.1760	●
17,70			3	9	3,3	.1770	●
17,80	MJ20x2,5		3	9	3,3	.1780	●
17,90			3	9	3,3	.1790	●
18,00	M20x2		3	9	3,3	.1800	●
18,10			3	9	3,3	.1810	●
18,20			3	9	3,4	.1820	●
18,30			3	9	3,4	.1830	●
18,40			3	9	3,4	.1840	●
18,50	M20x1,5		3	9	3,4	.1850	●
18,60	MJ20x1,5		3	9	3,4	.1860	●
18,70			3	9	3,5	.1870	●

Vollhartmetall-Schneidkopf
Solid carbide cutting head

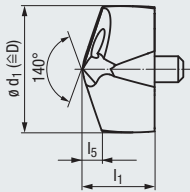

VHM **TIALN T21**

R30

Z2 **2FF**

140° **IT9-IT11**

new

STEEL
Steel materials

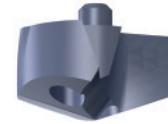

- Product Finder
- v_c / f
- STEEL
- VA
- GG
- HCUT
- Zubehör
Accessories
- Tech. Info

Einsatzgebiete – Material Applications – material » 510

P 1.1-5.1 **M** 1.1
K 1.1-4.2 **N** 1.4-5

Werkzeug-Ident · Tool ident

TM003324

$\varnothing d_1$ k8	Gewindebohrer Taps	Gewindeformer Cold-forming taps	Plattensitzgröße Size of insert seat	l_1	l_5	Dimens.- Ident	EF-Drill Modular STEEL AK-2FF TIALN-T21
18,80			3	9	3,5	.1880	●
18,85		M20	3	9	3,5	.1885	●
18,90			3	9	3,5	.1890	●
19,00	M20x1		4	11	3,5	.1900	●
19,10	MJ20x1	M20x2	4	11	3,5	.1910	●
19,20			4	11	3,5	.1920	●
19,30			4	11	3,6	.1930	●
19,35		M20x1,5	4	11	3,6	.1935	●
19,40			4	11	3,6	.1940	●
19,50	M22		4	11	3,6	.1950	●
19,60		M20x1	4	11	3,6	.1960	●
19,70			4	11	3,6	.1970	●
19,80			4	11	3,7	.1980	●
19,90			4	11	3,7	.1990	●
20,00	M22x2		4	11	3,7	.2000	●
20,10			4	11	3,7	.2010	●
20,20			4	11	3,7	.2020	●
20,30			4	11	3,7	.2030	●
20,40			4	11	3,8	.2040	●
20,50	M22x1,5		4	11	3,8	.2050	●
20,60	MJ22x1,5		4	11	3,8	.2060	●
20,70			4	11	3,8	.2070	●
20,80			4	11	3,8	.2080	●
20,85		M22	4	11	3,8	.2085	●
20,90			4	11	3,9	.2090	●
21,00	M24 / M22x1		4	11	3,9	.2100	●
21,10	MJ22x1	M22x2	4	11	3,9	.2110	●
21,20			4	11	3,9	.2120	●
21,30			4	11	3,9	.2130	●
21,35		M22x1,5	4	11	3,9	.2135	●
21,40			4	11	3,9	.2140	●
21,50			4	11	4,0	.2150	●
21,60		M22x1	4	11	4,0	.2160	●
21,70			4	11	4,0	.2170	●
21,80			4	11	4,0	.2180	●
21,90			4	11	4,0	.2190	●
22,00	M24x2		5	12,5	4,1	.2200	●
22,10			5	12,5	4,1	.2210	●
22,20			5	12,5	4,1	.2220	●
22,30			5	12,5	4,1	.2230	●
22,40			5	12,5	4,1	.2240	●
22,50	M24x1,5		5	12,5	4,1	.2250	●
22,60	MJ24x1,5	M24	5	12,5	4,2	.2260	●
22,65			5	12,5	4,2	.2265	●
22,70			5	12,5	4,2	.2270	●
22,80			5	12,5	4,2	.2280	●
22,90			5	12,5	4,2	.2290	●
23,00	M24x1		5	12,5	4,2	.2300	●
23,10		M24x2	5	12,5	4,3	.2310	●
23,20			5	12,5	4,3	.2320	●
23,30			5	12,5	4,3	.2330	●

- 3 x D
- 5 x D
- 6 x D
- 8 x D
- 2-3,5 x D



● = Lagerwerkzeug, siehe Preisliste · Stock tool, see price list
○ = Kurzfristig lieferbar, Preis auf Anfrage · Available on short notice, price upon inquiry

- Product Finder
- v_c / f
- STEEL
- VA
- GG
- HCUT
- Zubehör Accessories
- Tech. Info

Vollhartmetall-Schneidkopf
Solid carbide cutting head

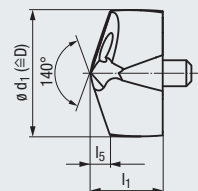

VHM TIALN T21

R30

Z2 2FF

140° IT9-IT11

new

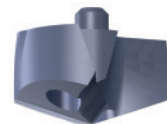

STEEL
Steel materials

Einsatzgebiete – Material
Applications – material



P 1.1-5.1 M 1.1
K 1.1-4.2 N 1.4-5

Werkzeug-Ident · Tool ident

TM003324

- 3 x D
- 5 x D
- 6 x D
- 8 x D
- 2-3,5 x D

ϕd_1 k8	Gewindebohrer Taps	Gewindeformer Cold-forming taps	Plattensitzgröße Size of insert seat	l_1	l_5	Dimens.- Ident	EF-Drill Modular STEEL AK-2FF TIALN-T21
23,35		M24x1,5	5	12,5	4,3	.2335	●
23,40			5	12,5	4,3	.2340	●
23,50	M25x1,5		5	12,5	4,3	.2350	●
23,60	MJ25x1,5	M24x1	5	12,5	4,3	.2360	●
23,70			5	12,5	4,4	.2370	●
23,80			5	12,5	4,4	.2380	●
23,90			5	12,5	4,4	.2390	●
24,00	M27		5	12,5	4,4	.2400	●
24,10	MJ25x1		5	12,5	4,4	.2410	●
24,20			5	12,5	4,5	.2420	●
24,30			5	12,5	4,5	.2430	●
24,40			5	12,5	4,5	.2440	●
24,50	M26x1,5		5	12,5	4,5	.2450	●
24,60	MJ26x1,5		5	12,5	4,5	.2460	●
24,70			5	12,5	4,5	.2470	●
24,80			5	12,5	4,6	.2480	●
24,90			5	12,5	4,6	.2490	●
25,00	M27x2		5	12,5	4,6	.2500	●
25,10			5	12,5	4,6	.2510	●
25,20			5	12,5	4,6	.2520	●
25,30			5	12,5	4,7	.2530	●
25,40			5	12,5	4,7	.2540	●
25,50	M27x1,5		5	12,5	4,7	.2550	●
25,60	MJ27x1,5	M27	5	12,5	4,7	.2560	●
25,65			5	12,5	4,7	.2565	●
25,70			5	12,5	4,7	.2570	●
25,80			5	12,5	4,7	.2580	●
25,90			5	12,5	4,8	.2590	●
26,00	M27x1 / M28x2		6	15	4,8	.2600	●
26,10		M27x2	6	15	4,8	.2610	●
26,20			6	15	4,8	.2620	●
26,30			6	15	4,8	.2630	●
26,40			6	15	4,9	.2640	●
26,50	M30 / M28x1,5		6	15	4,9	.2650	●
26,60	MJ28x1,5	M27x1	6	15	4,9	.2660	●
26,70			6	15	4,9	.2670	●
26,80			6	15	4,9	.2680	●
26,90			6	15	4,9	.2690	●
27,00	M30x3		6	15	5,0	.2700	●
27,10	MJ28x1		6	15	5,0	.2710	●
27,20			6	15	5,0	.2720	●
27,30			6	15	5,0	.2730	●
27,40			6	15	5,0	.2740	●
27,50			6	15	5,1	.2750	●
27,60			6	15	5,1	.2760	●
27,70			6	15	5,1	.2770	●
27,80			6	15	5,1	.2780	●
27,90			6	15	5,1	.2790	●
28,00	M30x2		6	15	5,1	.2800	●
28,10			6	15	5,2	.2810	●
28,20			6	15	5,2	.2820	●

Vollhartmetall-Schneidkopf
Solid carbide cutting head

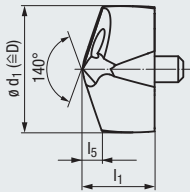

VHM **TIALN T21**

R30

Z2 **2FF**

140° **IT9-IT11**

new

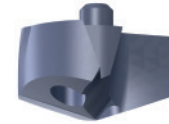

STEEL
Steel materials

Product Finder

v_c / f

STEEL

VA

GG

HCUT

Zubehör
Accessories

Tech. Info

Einsatzgebiete – Material Applications – material 510

P 1.1-5.1 **M** 1.1
K 1.1-4.2 **N** 1.4-5

Werkzeug-Ident · Tool ident

TM003324

$\varnothing d_1$ k8	Gewindebohrer Taps	Gewindeformer Cold-forming taps	Plattensitzgröße Size of insert seat	l_1	l_5	Dimens.- Ident	EF-Drill Modular STEEL AK-2FF TIALN-T21
28,30			6	15	5,2	.2830	●
28,40			6	15	5,2	.2840	●
28,50	M30x1,5		6	15	5,2	.2850	●
28,60	MJ30x1,5	M30x3	6	15	5,3	.2860	●
28,70			6	15	5,3	.2870	●
28,80			6	15	5,3	.2880	●
28,90			6	15	5,3	.2890	●
29,00	M30x1		6	15	5,3	.2900	●
29,10	MJ30x1	M30x2	6	15	5,3	.2910	●
29,20			6	15	5,4	.2920	●
29,30			6	15	5,4	.2930	●
29,35		M30x1,5	6	15	5,4	.2935	●
29,40			6	15	5,4	.2940	●
29,50	M33		6	15	5,4	.2950	●
29,60		M30x1	6	15	5,4	.2960	●
29,70			6	15	5,5	.2970	●
29,80			6	15	5,5	.2980	●
29,90			6	15	5,5	.2990	●
30,00	M32x2 / M33x3		7	17	5,5	.3000	●
30,10			7	17	5,5	.3010	●
30,20			7	17	5,5	.3020	●
30,30			7	17	5,6	.3030	●
30,40			7	17	5,6	.3040	●
30,50	M32x1,5		7	17	5,6	.3050	●
30,60	MJ32x1,5		7	17	5,6	.3060	●
30,70			7	17	5,6	.3070	●
30,80			7	17	5,7	.3080	●
30,90			7	17	5,7	.3090	●
31,00	M33x2		7	17	5,7	.3100	●
31,10	MJ32x1		7	17	5,7	.3110	●
31,20			7	17	5,7	.3120	●
31,30			7	17	5,7	.3130	●
31,40			7	17	5,8	.3140	●
31,50	M33x1,5		7	17	5,8	.3150	●
31,60		M33x3	7	17	5,8	.3160	●
31,70			7	17	5,8	.3170	●
31,80			7	17	5,8	.3180	●
31,90			7	17	5,9	.3190	●
32,00	M36		7	17	5,9	.3200	●

3 x D
5 x D
6 x D
8 x D
2-3,5 x D



● = Lagerwerkzeug, siehe Preisliste · Stock tool, see price list
○ = Kurzfristig lieferbar, Preis auf Anfrage · Available on short notice, price upon inquiry

- Product Finder
- v_c / f
- STEEL
- VA
- GG
- HCUT
- Zubehör Accessories
- Tech. Info

R30



new

new



Trägerwerkzeug, kurze Ausführung
Tool body, short design

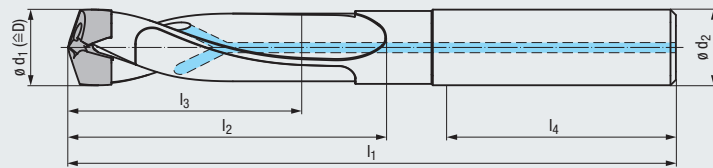

3 x D

Bohrtiefe
Drill depth

Werkzeug-Ident · Tool ident

TM200000

TM500000

$\varnothing d_1$ min.	$\varnothing d_1$ max.	Plattensitzgröße Size of insert seat	l_1	l_2	l_3	l_4	$\varnothing d_2$ h6	Dimens.- Ident	EF-Drill Modular	EF-Drill Modular
									DIN 6535 HA 3 x D	DIN 6535 HE 3 x D
14,00	14,49	2	124	65	43	48	16	.1400	●	●
14,50	14,99	2	125	67	45	48	16	.1450	●	●
15,00	15,99	2	129	72	48	48	16	.1500	●	●
16,00	16,99	3	136	76	51	48	18	.1600	●	●
17,00	17,99	3	139	81	54	48	18	.1700	●	●
18,00	18,99	3	147	85	57	50	20	.1800	●	●
19,00	19,99	4	150	90	60	50	20	.1900	●	●
20,00	20,99	4	165	94	63	56	25	.2000	●	●
21,00	21,99	4	169	99	66	56	25	.2100	●	●
22,00	22,99	5	173	103	69	56	25	.2200	●	●
23,00	23,99	5	177	108	72	56	25	.2300	●	●
24,00	24,99	5	181	112	75	56	25	.2400	●	●
25,00	25,99	5	194	117	78	60	32	.2500	●	●
26,00	26,99	6	199	121	81	60	32	.2600	●	●
27,00	27,99	6	202	126	84	60	32	.2700	●	●
28,00	28,99	6	207	130	87	60	32	.2800	●	●
29,00	29,99	6	210	135	90	60	32	.2900	●	●
30,00	30,99	7	215	139	93	60	32	.3000	●	●
31,00	31,99	7	218	144	96	60	32	.3100	●	●
32,00	32,99	7	223	148	99	60	32	.3200	●	●

Lieferumfang: ohne Vollhartmetall-Schneidkopf, mit Torx-Schrauben
Delivery: without solid carbide cutting head, with Torx screws

Vollhartmetall-Schneidköpfe siehe Seite 540 - 543
Solid carbide cutting heads, see page 540 - 543

Schraubendreher · Screwdriver



Spannschraube · Clamping Screw



Plattensitzgröße Size of insert seat	Größe Size	Klingendurchmesser Blade diameter	Artikel-Nr. Article no.	
2	Torx T7	2,5	TM919099	●
3	Torx T8	3,5	TM919199	●
4	Torx T8	3,5	TM919199	●
5	Torx T9	4	TM919299	●
6	Torx T15	4	TM919399	●
7	Torx T15	4	TM919399	●

Plattensitzgröße Size of insert seat	Größe Size	M_d max.	Artikel-Nr. Article no.	
2	M2,2 x 6 x Torx T7	0,60 Nm	TM909090.0600	●
3	M2,5 x 6,5 x Torx T8	0,88 Nm	TM909191.0650	●
4	M3 x 7,5 x Torx T8	1,53 Nm	TM909192.0750	●
5	M3,5 x 8,5 x Torx T9	2,44 Nm	TM909293.0850	●
6	M4 x 10 x Torx T15	3,66 Nm	TM909394.1000	●
7	M4,5 x 11 x Torx T15	5,22 Nm	TM909395.1100	●

Trägerwerkzeug, lange Ausführung
Tool body, long design

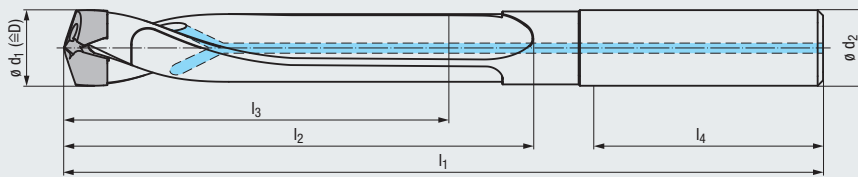

R30

Z2 **2FF**

DIN 6535 **IT10-IT11**

HA HE

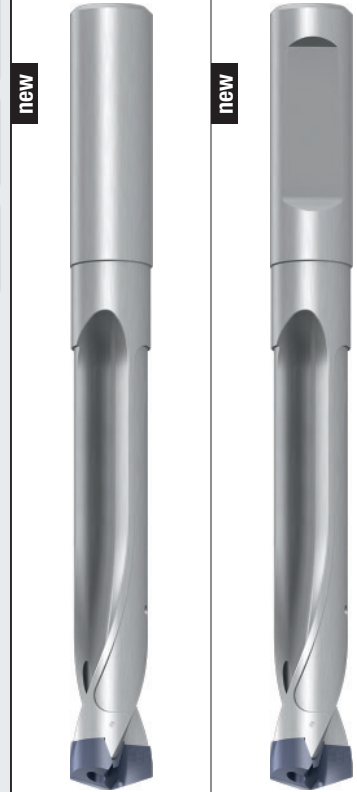

Bohrtiefe
Drill depth

5 x D

Werkzeug-Ident · Tool ident

ø d ₁ min.	ø d ₁ max.	Plattensitzgröße Size of insert seat	l ₁	l ₂	l ₃	l ₄	ø d ₂ h6	Dimens.- Ident	TM210000	TM510000
									EF-Drill Modular DIN 6535 HA 5 x D	EF-Drill Modular DIN 6535 HE 5 x D
14,00	14,49	2	153	94	72	48	16	.1400	●	●
14,50	14,99	2	155	97	75	48	16	.1450	●	●
15,00	15,99	2	161	104	80	48	16	.1500	●	●
16,00	16,99	3	170	110	85	48	18	.1600	●	●
17,00	17,99	3	175	117	90	48	18	.1700	●	●
18,00	18,99	3	185	123	95	50	20	.1800	●	●
19,00	19,99	4	190	130	100	50	20	.1900	●	●
20,00	20,99	4	207	136	105	56	25	.2000	●	●
21,00	21,99	4	213	143	110	56	25	.2100	●	●
22,00	22,99	5	219	149	115	56	25	.2200	●	●
23,00	23,99	5	225	156	120	56	25	.2300	●	●
24,00	24,99	5	231	162	125	56	25	.2400	●	●
25,00	25,99	5	246	169	130	60	32	.2500	●	●
26,00	26,99	6	253	175	135	60	32	.2600	●	●
27,00	27,99	6	258	182	140	60	32	.2700	●	●
28,00	28,99	6	265	188	145	60	32	.2800	●	●
29,00	29,99	6	270	195	150	60	32	.2900	●	●
30,00	30,99	7	277	201	155	60	32	.3000	●	●
31,00	31,99	7	282	208	160	60	32	.3100	●	●
32,00	32,99	7	289	214	165	60	32	.3200	●	●

Lieferumfang: ohne Vollhartmetall-Schneidkopf, mit Torx-Schrauben
Delivery: without solid carbide cutting head, with Torx screws

Vollhartmetall-Schneidköpfe siehe Seite 540 - 543
Solid carbide cutting heads, see page 540 - 543

Schraubendreher · Screwdriver



Plattensitzgröße Size of insert seat	Größe Size	Klingendurchmesser Blade diameter	Artikel-Nr. Article no.	
2	Torx T7	2,5	TM919099	●
3	Torx T8	3,5	TM919199	●
4	Torx T8	3,5	TM919199	●
5	Torx T9	4	TM919299	●
6	Torx T15	4	TM919399	●
7	Torx T15	4	TM919399	●

Spannschraube · Clamping Screw



Plattensitzgröße Size of insert seat	Größe Size	M _d max.	Artikel-Nr. Article no.	
2	M2,2 x 6 x Torx T7	0,60 Nm	TM909090.0600	●
3	M2,5 x 6,5 x Torx T8	0,88 Nm	TM909191.0650	●
4	M3 x 7,5 x Torx T8	1,53 Nm	TM909192.0750	●
5	M3,5 x 8,5 x Torx T9	2,44 Nm	TM909293.0850	●
6	M4 x 10 x Torx T15	3,66 Nm	TM909394.1000	●
7	M4,5 x 11 x Torx T15	5,22 Nm	TM909395.1100	●

● = Lagerwerkzeug, siehe Preisliste · Stock tool, see price list
○ = Kurzfristig lieferbar, Preis auf Anfrage · Available on short notice, price upon inquiry

- Product Finder
- v_c / f
- STEEL
- VA
- GG
- HCUT
- Zubehör Accessories
- Tech. Info

Für die Bearbeitung von nichtrostenden Stahlwerkstoffen
 For the machining of stainless steel materials

VHM

ALCR T37

DIN 6537 K

R30

Z2

2FF

140°

IT9-IT10

DIN 6535

HA

HE

VA
Stainless steel materials

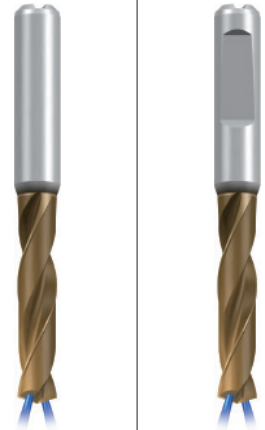

Kurze Ausführung
Short design

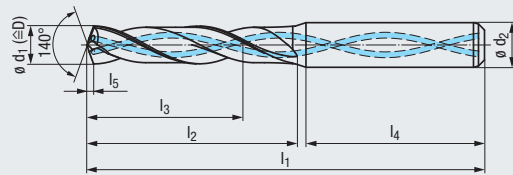

Bohrtiefe
Drill depth

3 x D

Einsatzgebiete – Material
Applications – material » 510

M 1.1-4.1

S 1.1-3

S 2.2, 2.4, 2.6

N 1.1-3

Werkzeug-Ident · Tool ident

TA204524 TA504524

ø d ₁ m7	Gewindebohrer Taps	Gewindeformer Cold-forming taps						ø d ₂ h6	Dimens.- Ident	TA204524	TA504524
			l ₁	l ₂	l ₃	l ₄	l ₅			EF-Drill-VA DIN6537K-HA IK-2FF ALCR-T37	EF-Drill-VA DIN6537K-HE IK-2FF ALCR-T37
2,80		M3	57	16	11	36	0,6	6	.0280	●	●
2,85			57	16	11	36	0,6	6	.0285	●	●
2,90	M3,5	M3x0,25	57	16	11	36	0,6	6	.0290	●	●
3,00	M3,5x0,5 / MJ3,5x0,6		62	20	14	36	0,6	6	.0300	●	●
3,10			62	20	14	36	0,6	6	.0310	●	●
3,15	M3,5x0,35		62	20	14	36	0,6	6	.0315	●	●
3,20	MJ3,5x0,35		62	20	14	36	0,6	6	.0320	●	●
3,25		M3,5	62	20	14	36	0,6	6	.0325	●	●
3,30	M4	M3,5x0,5	62	20	14	36	0,7	6	.0330	●	●
3,35			62	20	14	36	0,7	6	.0335	●	●
3,38		M3,5x0,35	62	20	14	36	0,7	6	.0338	●	●
3,40	MJ4x0,7		62	20	14	36	0,7	6	.0340	●	●
3,50	M4x0,5		62	20	14	36	0,7	6	.0350	●	●
3,55			62	20	14	36	0,7	6	.0355	●	●
3,60	MJ4x0,5		62	20	14	36	0,7	6	.0360	●	●
3,65	M4x0,35		62	20	14	36	0,7	6	.0365	●	●
3,70	M4,5	M4	62	20	14	36	0,7	6	.0370	●	●
3,80		M4x0,5	66	24	17	36	0,7	6	.0380	●	●
3,88		M4x0,35	66	24	17	36	0,8	6	.0388	●	●
3,90	MJ4,5x0,75		66	24	17	36	0,8	6	.0390	●	●
4,00			66	24	17	36	0,8	6	.0400	●	●
4,10	MJ4,5x0,5		66	24	17	36	0,8	6	.0410	●	●
4,15	M5x0,9		66	24	17	36	0,8	6	.0415	●	●
4,20	M5 / M5x0,75	M4,5	66	24	17	36	0,8	6	.0420	●	●
4,30	MJ5x0,8	M4,5x0,5	66	24	17	36	0,8	6	.0430	●	●
4,35			66	24	17	36	0,8	6	.0435	●	●
4,40			66	24	17	36	0,9	6	.0440	●	●
4,45			66	24	17	36	0,9	6	.0445	●	●
4,50	M5x0,5		66	24	17	36	0,9	6	.0450	●	●
4,60	M5,5 / MJ5x0,5		66	24	17	36	0,9	6	.0460	●	●
4,65		M5	66	24	17	36	0,9	6	.0465	●	●
4,70		M5x0,75	66	24	17	36	0,9	6	.0470	●	●
4,80		M5x0,5	66	28	20	36	0,9	6	.0480	●	●
4,90			66	28	20	36	0,9	6	.0490	●	●
5,00	M6		66	28	20	36	1,0	6	.0500	●	●
5,10	MJ6x1	M5,5	66	28	20	36	1,0	6	.0510	●	●
5,20	M6x0,75		66	28	20	36	1,0	6	.0520	●	●
5,25			66	28	20	36	1,0	6	.0525	●	●
5,30		M5,5x0,5	66	28	20	36	1,0	6	.0530	●	●
5,40			66	28	20	36	1,0	6	.0540	●	●
5,50	M6x0,5		66	28	20	36	1,1	6	.0550	●	●
5,55			66	28	20	36	1,1	6	.0555	●	●
5,60	MJ6x0,5	M6	66	28	20	36	1,1	6	.0560	●	●

Für die Bearbeitung von nichtrostenden Stahlwerkstoffen
For the machining of stainless steel materials

VHM **ALCR T37**

DIN 6537 K **R30**

Z2 **2FF**

140° **IT9-IT10**

DIN 6535
HA HE

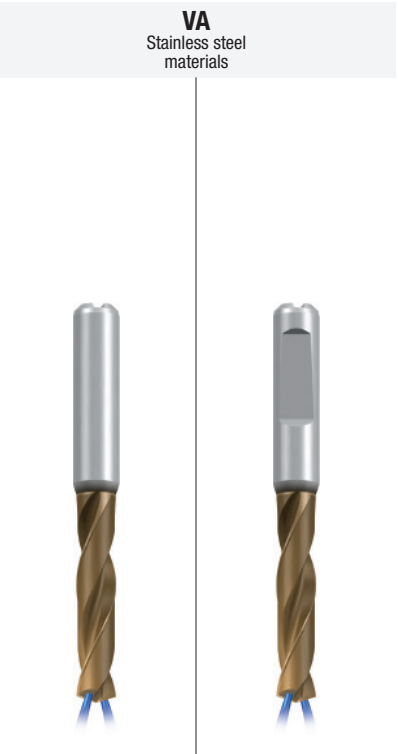

- Product Finder
- vc / f
- STEEL
- VA
- GG
- HCUT
- Zubehör
Accessories
- Tech. Info

Kurze Ausführung
Short design

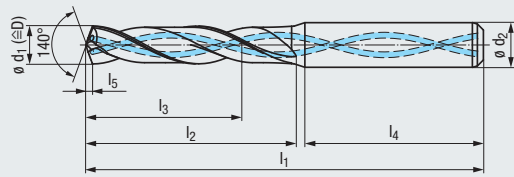

Bohrtiefe
Drill depth

3 x D

Einsatzgebiete – Material
Applications – material 510

M 1.1-4.1 **S** 1.1-3 **S** 2.2,2.4,2.6
N 1.1-3

- 3 x D
- 5 x D
- 6 x D
- 8 x D
- 2-3,5 x D

Werkzeug-Ident · Tool ident

Ø d ₁ m7	Gewindebohrer Taps	Gewindeformer Cold-forming taps						Ø d ₂ h6	Dimens.- Ident	TA204524	TA504524
			l ₁	l ₂	l ₃	l ₄	l ₅			EF-Drill-VA DIN6537K-HA IK-2FF ALCR-T37	EF-Drill-VA DIN6537K-HE IK-2FF ALCR-T37
5,70		M6x0,75	66	28	20	36	1,1	6	.0570	●	●
5,80		M6x0,5	66	28	20	36	1,1	6	.0580	●	●
5,90			66	28	20	36	1,1	6	.0590	●	●
6,00	M7		66	28	20	36	1,1	6	.0600	●	●
6,10	MJ7x1		79	34	24	36	1,2	8	.0610	●	●
6,20	M7x0,75		79	34	24	36	1,2	8	.0620	●	●
6,30			79	34	24	36	1,2	8	.0630	●	●
6,35	MJ7x0,75		79	34	24	36	1,2	8	.0635	●	●
6,40			79	34	24	36	1,2	8	.0640	●	●
6,50	M7x0,5		79	34	24	36	1,2	8	.0650	●	●
6,60		M7	79	34	24	36	1,3	8	.0660	●	●
6,70		M7x0,75	79	34	24	36	1,3	8	.0670	●	●
6,80	M8	M7x0,5	79	34	24	36	1,3	8	.0680	●	●
6,90	MJ8x1,25		79	34	24	36	1,3	8	.0690	●	●
7,00	M8x1		79	34	24	36	1,3	8	.0700	●	●
7,10	MJ8x1		79	41	29	36	1,3	8	.0710	●	●
7,20	M8x0,75		79	41	29	36	1,4	8	.0720	●	●
7,30			79	41	29	36	1,4	8	.0730	●	●
7,40			79	41	29	36	1,4	8	.0740	●	●
7,45		M8	79	41	29	36	1,4	8	.0745	●	●
7,50	M8x0,5		79	41	29	36	1,4	8	.0750	●	●
7,60		M8x1	79	41	29	36	1,4	8	.0760	●	●
7,70		M8x0,75	79	41	29	36	1,5	8	.0770	●	●
7,80	M9	M8x0,5	79	41	29	36	1,5	8	.0780	●	●
7,90	MJ9x1,25		79	41	29	36	1,5	8	.0790	●	●
8,00	M9x1		79	41	29	36	1,5	8	.0800	●	●
8,10	MJ9x1		89	47	35	40	1,5	10	.0810	●	●
8,20	M9x0,75		89	47	35	40	1,5	10	.0820	●	●
8,30			89	47	35	40	1,6	10	.0830	●	●
8,40			89	47	35	40	1,6	10	.0840	●	●
8,45		M9	89	47	35	40	1,6	10	.0845	●	●
8,50	M10 / M9x0,5		89	47	35	40	1,6	10	.0850	●	●
8,60	MJ10x1,5	M9x1	89	47	35	40	1,6	10	.0860	●	●
8,70		M9x0,75	89	47	35	40	1,6	10	.0870	●	●
8,80	M10x1,25	M9x0,5	89	47	35	40	1,7	10	.0880	●	●
8,90	MJ10x1,25		89	47	35	40	1,7	10	.0890	●	●
9,00	M10x1		89	47	35	40	1,7	10	.0900	●	●
9,10	MJ10x1		89	47	35	40	1,7	10	.0910	●	●
9,20	M10x0,75		89	47	35	40	1,7	10	.0920	●	●
9,30			89	47	35	40	1,7	10	.0930	●	●
9,35	MJ10x0,75	M10	89	47	35	40	1,8	10	.0935	●	●
9,40			89	47	35	40	1,8	10	.0940	●	●
9,45		M10x1,25	89	47	35	40	1,8	10	.0945	●	●

● = Lagerwerkzeug, siehe Preisliste · Stock tool, see price list
○ = Kurzfristig lieferbar, Preis auf Anfrage · Available on short notice, price upon inquiry

Ø 9,50 mm - Ø 20,00 mm



- Product Finder
- v_c / f
- STEEL
- VA
- GG
- HCUT
- Zubehör Accessories
- Tech. Info

Für die Bearbeitung von nichtrostenden Stahlwerkstoffen
 For the machining of stainless steel materials

VHM

ALCR T37

DIN 6537 K

R30

Z2

2FF

140°

IT9-IT10

DIN 6535

HA

HE

VA
Stainless steel materials

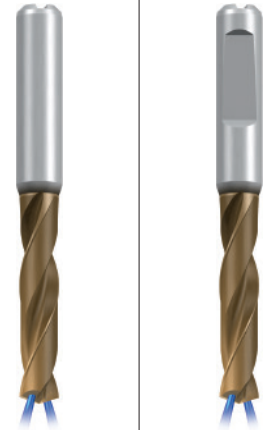

Kurze Ausführung
Short design

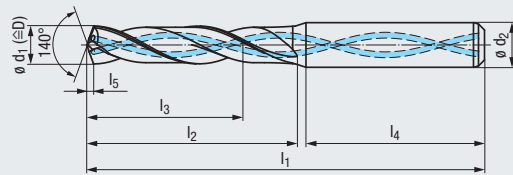

Bohrtiefe
Drill depth

3 x D

Einsatzgebiete – Material
Applications – material » 510

M 1.1-4.1

S 1.1-3

S 2.2, 2.4, 2.6

N 1.1-3

Werkzeug-Ident · Tool ident

TA204524 TA504524

$\varnothing d_1$ m7	Gewindebohrer Taps	Gewindeformer Cold-forming taps						$\varnothing d_2$ h6	Dimens.- Ident	EF-Drill-VA DIN6537K-HA IK-2FF ALCR-T37	EF-Drill-VA DIN6537K-HE IK-2FF ALCR-T37
			l_1	l_2	l_3	l_4	l_5			TA204524	TA504524
9,50	M11 / M10x0,5		89	47	35	40	1,8	10	.0950	●	●
9,60	MJ10x0,5 / MJ11x1,5	M10x1	89	47	35	40	1,8	10	.0960	●	●
9,70		M10x0,75	89	47	35	40	1,8	10	.0970	●	●
9,80		M10x0,5	89	47	35	40	1,8	10	.0980	●	●
9,90	MJ11x1,25		89	47	35	40	1,9	10	.0990	●	●
10,00	M11x1		89	47	35	40	1,9	10	.1000	●	●
10,10	MJ11x1		102	55	40	45	1,9	12	.1010	●	●
10,20	M12 / M11x0,75		102	55	40	45	1,9	12	.1020	●	●
10,30			102	55	40	45	1,9	12	.1030	●	●
10,35	MJ11x0,75	M11	102	55	40	45	1,9	12	.1035	●	●
10,40			102	55	40	45	1,9	12	.1040	●	●
10,50	M12x1,5		102	55	40	45	2,0	12	.1050	●	●
10,60	MJ12x1,5	M11x1	102	55	40	45	2,0	12	.1060	●	●
10,70		M11x0,75	102	55	40	45	2,0	12	.1070	●	●
10,80	M12x1,25		102	55	40	45	2,0	12	.1080	●	●
10,90	MJ12x1,25		102	55	40	45	2,0	12	.1090	●	●
11,00	M12x1		102	55	40	45	2,1	12	.1100	●	●
11,10	MJ12x1		102	55	40	45	2,1	12	.1110	●	●
11,20	M12x0,75		102	55	40	45	2,1	12	.1120	●	●
11,25		M12	102	55	40	45	2,1	12	.1125	●	●
11,30			102	55	40	45	2,1	12	.1130	●	●
11,35		M12x1,5	102	55	40	45	2,1	12	.1135	●	●
11,40			102	55	40	45	2,1	12	.1140	●	●
11,45		M12x1,25	102	55	40	45	2,1	12	.1145	●	●
11,50			102	55	40	45	2,1	12	.1150	●	●
11,60		M12x1	102	55	40	45	2,2	12	.1160	●	●
11,70		M12x0,75	102	55	40	45	2,2	12	.1170	●	●
11,80			102	55	40	45	2,2	12	.1180	●	●
11,90			102	55	40	45	2,2	12	.1190	●	●
12,00	M14		102	55	40	45	2,2	12	.1200	●	●
12,20			107	60	43	45	2,3	14	.1220	●	●
12,30			107	60	43	45	2,3	14	.1230	●	●
12,50	M14x1,5		107	60	43	45	2,3	14	.1250	●	●
12,60	MJ14x1,5	M13x1	107	60	43	45	2,3	14	.1260	●	●
12,70		M13x0,75	107	60	43	45	2,4	14	.1270	●	●
12,80	M14x1,25		107	60	43	45	2,4	14	.1280	●	●
12,90	MJ14x1,25		107	60	43	45	2,4	14	.1290	●	●
13,00	M14x1		107	60	43	45	2,4	14	.1300	●	●
13,10	MJ14x1	M14	107	60	43	45	2,4	14	.1310	●	●
13,20	M14x0,75		107	60	43	45	2,5	14	.1320	●	●
13,30			107	60	43	45	2,5	14	.1330	●	●
13,35		M14x1,5	107	60	43	45	2,5	14	.1335	●	●
13,45		M14x1,25	107	60	43	45	2,5	14	.1345	●	●

Für die Bearbeitung von nichtrostenden Stahlwerkstoffen
For the machining of stainless steel materials

VHM **ALCR T37**

DIN 6537 K **R30**

Z2 **2FF**

140° **IT9-IT10**

DIN 6535
HA HE

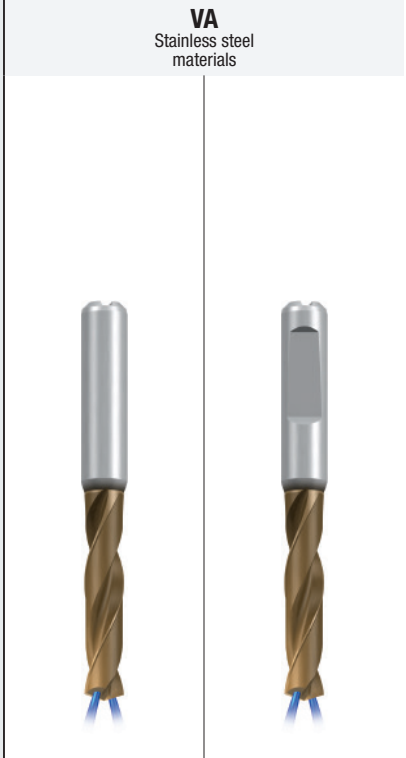

- Product Finder
- v_c / f
- STEEL
- VA
- GG
- HCUT
- Zubehör Accessories
- Tech. Info

Kurze Ausführung
Short design

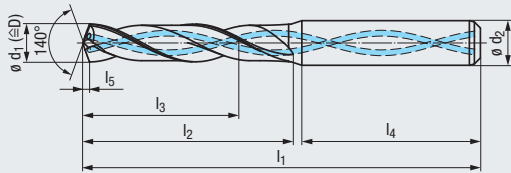

Bohrtiefe
Drill depth

3 x D

Einsatzgebiete – Material
Applications – material 510

M 1.1-4.1 **S** 1.1-3 **S** 2.2,2.4,2.6
N 1.1-3

- 3 x D
- 5 x D
- 6 x D
- 8 x D
- 2-3,5 x D

Werkzeug-Ident · Tool ident

$\varnothing d_1$ m7	Gewindebohrer Taps	Gewindeformer Cold-forming taps						$\varnothing d_2$ h6	Dimens.- Ident	TA204524	TA504524
			l_1	l_2	l_3	l_4	l_5			EF-Drill-VA DIN6537K-HA IK-2FF ALCR-T37	EF-Drill-VA DIN6537K-HE IK-2FF ALCR-T37
13,50			107	60	43	45	2,5	14	.1350	●	●
13,60	MJ15x1,5	M14x1	107	60	43	45	2,5	14	.1360	●	●
13,70		M14x0,75	107	60	43	45	2,5	14	.1370	●	●
13,80			107	60	43	45	2,6	14	.1380	●	●
14,00	M16 / M15x1		107	60	43	45	2,6	14	.1400	●	●
14,10	MJ15x1		115	65	45	48	2,6	16	.1410	●	●
14,30			115	65	45	48	2,7	16	.1430	●	●
14,40			115	65	45	48	2,7	16	.1440	●	●
14,50	M16x1,5		115	65	45	48	2,7	16	.1450	●	●
14,60	MJ16x1,5	M15x1	115	65	45	48	2,7	16	.1460	●	●
14,70		M15x0,75	115	65	45	48	2,7	16	.1470	●	●
14,80			115	65	45	48	2,7	16	.1480	●	●
15,00	M16x1		115	65	45	48	2,8	16	.1500	●	●
15,10	MJ16x1	M16	115	65	45	48	2,8	16	.1510	●	●
15,35		M16x1,5	115	65	45	48	2,8	16	.1535	●	●
15,50	M18		115	65	45	48	2,9	16	.1550	●	●
15,60		M16x1	115	65	45	48	2,9	16	.1560	●	●
16,00	M18x2		115	65	45	48	3,0	16	.1600	●	●
16,50	M18x1,5		123	73	51	48	3,1	18	.1650	●	●
17,00	M18x1		123	73	51	48	3,1	18	.1700	●	●
17,50	M20		123	73	51	48	3,2	18	.1750	●	●
17,60		M18x1	123	73	51	48	3,3	18	.1760	●	●
18,00	M20x2		123	73	51	48	3,3	18	.1800	●	●
18,50	M20x1,5		131	79	55	50	3,4	20	.1850	●	●
18,85		M20	131	79	55	50	3,5	20	.1885	●	●
19,00	M20x1		131	79	55	50	3,5	20	.1900	●	●
19,35		M20x1,5	131	79	55	50	3,6	20	.1935	●	●
19,50	M22		131	79	55	50	3,6	20	.1950	●	●
19,60		M20x1	131	79	55	50	3,6	20	.1960	●	●
20,00	M22x2		131	79	55	50	3,7	20	.2000	●	●

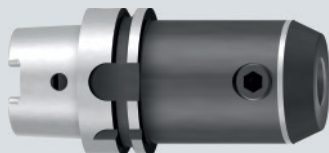

Werkzeug-Aufnahmen für Zylinderschäfte
mit geneigter Spannfläche
siehe Seite 562 - 563

Tool holders for straight shanks
with inclined clamping flat,
see page 562 - 563

- Product Finder
- v_c / f
- STEEL
- VA
- GG
- HCUT
- Zubehör
Accessories
- Tech. Info

Für die Bearbeitung von nichtrostenden Stahlwerkstoffen
For the machining of stainless steel materials

VHM

ALCR
T37

DIN
6537 L

R30

Z2

2FF

140°

IT9-IT10

DIN 6535

HA

HE

VA
Stainless steel
materials

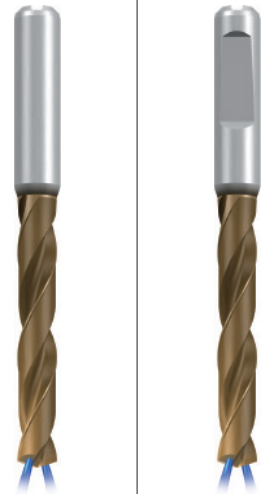

Lange Ausführung
Long design

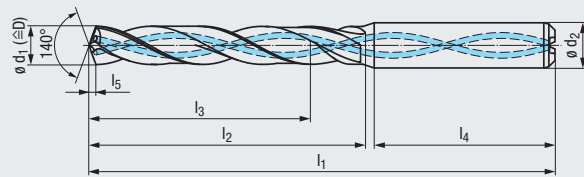

Bohrtiefe
Drill depth

5 x D

Einsatzgebiete – Material
Applications – material » 510

M 1.1-4.1 **S 1.1-3** **S 2.2, 2.4, 2.6**

Werkzeug-Ident · Tool ident

TA214524

TA514524

$\emptyset d_1$ m7	Gewindebohrer Taps 	Gewindeformer Cold-forming taps 						$\emptyset d_2$ h6	Dimens.- Ident	EF-Drill-VA DIN6537L-HA IK-2FF ALCR-T37	EF-Drill-VA DIN6537L-HE IK-2FF ALCR-T37
			l_1	l_2	l_3	l_4	l_5			TA214524	TA514524
2,80		M3	61	22	17	36	0,6	6	.0280	●	●
2,85			61	22	17	36	0,6	6	.0285	●	●
2,90	M3,5	M3x0,25	61	22	17	36	0,6	6	.0290	●	●
3,00	M3,5x0,5 / MJ3,5x0,6		66	28	23	36	0,6	6	.0300	●	●
3,10			66	28	23	36	0,6	6	.0310	●	●
3,15	M3,5x0,35		66	28	23	36	0,6	6	.0315	●	●
3,20	MJ3,5x0,35		66	28	23	36	0,6	6	.0320	●	●
3,25		M3,5	66	28	23	36	0,6	6	.0325	●	●
3,30	M4	M3,5x0,5	66	28	23	36	0,7	6	.0330	●	●
3,35			66	28	23	36	0,7	6	.0335	●	●
3,38		M3,5x0,35	66	28	23	36	0,7	6	.0338	●	●
3,40	MJ4x0,7		66	28	23	36	0,7	6	.0340	●	●
3,50	M4x0,5		66	28	23	36	0,7	6	.0350	●	●
3,55			66	28	23	36	0,7	6	.0355	●	●
3,60	MJ4x0,5		66	28	23	36	0,7	6	.0360	●	●
3,65	M4x0,35		66	28	23	36	0,7	6	.0365	●	●
3,70	M4,5	M4	66	28	23	36	0,7	6	.0370	●	●
3,80		M4x0,5	74	36	29	36	0,7	6	.0380	●	●
3,88		M4x0,35	74	36	29	36	0,8	6	.0388	●	●
3,90	MJ4,5x0,75		74	36	29	36	0,8	6	.0390	●	●
4,00			74	36	29	36	0,8	6	.0400	●	●
4,10	MJ4,5x0,5		74	36	29	36	0,8	6	.0410	●	●
4,15	M5x0,9		74	36	29	36	0,8	6	.0415	●	●
4,20	M5 / M5x0,75	M4,5	74	36	29	36	0,8	6	.0420	●	●
4,30	MJ5x0,8	M4,5x0,5	74	36	29	36	0,8	6	.0430	●	●
4,35			74	36	29	36	0,8	6	.0435	●	●
4,40			74	36	29	36	0,9	6	.0440	●	●
4,45			74	36	29	36	0,9	6	.0445	●	●
4,50	M5x0,5		74	36	29	36	0,9	6	.0450	●	●
4,60	M5,5 / MJ5x0,5		74	36	29	36	0,9	6	.0460	●	●
4,65		M5	74	36	29	36	0,9	6	.0465	●	●
4,70		M5x0,75	74	36	29	36	0,9	6	.0470	●	●
4,80		M5x0,5	82	44	35	36	0,9	6	.0480	●	●
4,90			82	44	35	36	0,9	6	.0490	●	●
5,00	M6		82	44	35	36	1,0	6	.0500	●	●
5,10	MJ6x1	M5,5	82	44	35	36	1,0	6	.0510	●	●
5,20	M6x0,75		82	44	35	36	1,0	6	.0520	●	●
5,25			82	44	35	36	1,0	6	.0525	●	●
5,30		M5,5x0,5	82	44	35	36	1,0	6	.0530	●	●
5,40			82	44	35	36	1,0	6	.0540	●	●
5,50	M6x0,5		82	44	35	36	1,1	6	.0550	●	●
5,55			82	44	35	36	1,1	6	.0555	●	●
5,60	MJ6x0,5	M6	82	44	35	36	1,1	6	.0560	●	●

Für die Bearbeitung von nichtrostenden Stahlwerkstoffen
For the machining of stainless steel materials

VHM **ALCR T37**

DIN 6537 L **R30**

Z2 **2FF**

140° **IT9-IT10**

DIN 6535
HA HE

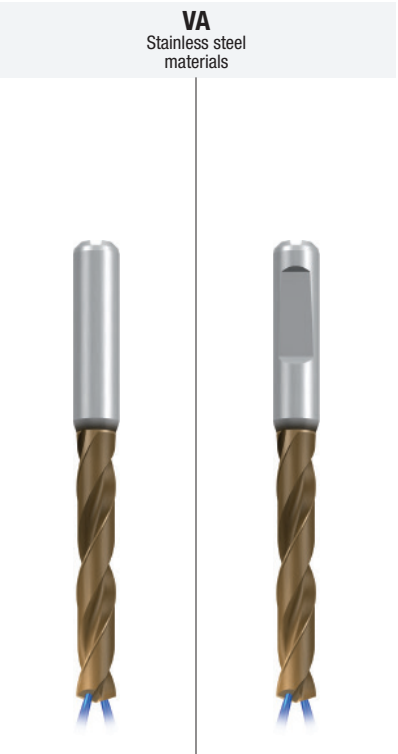

- Product Finder
- v_c / f
- STEEL
- VA
- GG
- HCUT
- Zubehör Accessories
- Tech. Info

Lange Ausführung
Long design

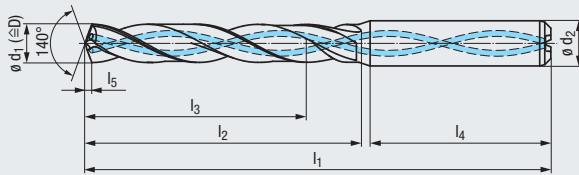

Bohrtiefe
Drill depth

5 x D

Einsatzgebiete – Material
Applications – material 510

M 1.1-4.1 **S 1.1-3** **S 2.2,2.4,2.6**

Werkzeug-Ident · Tool ident

ø d ₁ m7	Gewindebohrer Taps	Gewindeformer Cold-forming taps						ø d ₂ h6	Dimens.- Ident	TA214524	TA514524
			l ₁	l ₂	l ₃	l ₄	l ₅			EF-Drill-VA DIN6537L-HA IK-2FF ALCR-T37	EF-Drill-VA DIN6537L-HE IK-2FF ALCR-T37
5,70		M6x0,75	82	44	35	36	1,1	6	.0570	●	●
5,80		M6x0,5	82	44	35	36	1,1	6	.0580	●	●
5,90			82	44	35	36	1,1	6	.0590	●	●
6,00	M7		82	44	35	36	1,1	6	.0600	●	●
6,10	MJ7x1		91	53	43	36	1,2	8	.0610	●	●
6,20	M7x0,75		91	53	43	36	1,2	8	.0620	●	●
6,30			91	53	43	36	1,2	8	.0630	●	●
6,35	MJ7x0,75		91	53	43	36	1,2	8	.0635	●	●
6,40			91	53	43	36	1,2	8	.0640	●	●
6,50	M7x0,5		91	53	43	36	1,2	8	.0650	●	●
6,60		M7	91	53	43	36	1,3	8	.0660	●	●
6,70		M7x0,75	91	53	43	36	1,3	8	.0670	●	●
6,80	M8	M7x0,5	91	53	43	36	1,3	8	.0680	●	●
6,90	MJ8x1,25		91	53	43	36	1,3	8	.0690	●	●
7,00	M8x1		91	53	43	36	1,3	8	.0700	●	●
7,10	MJ8x1		91	53	43	36	1,3	8	.0710	●	●
7,20	M8x0,75		91	53	43	36	1,4	8	.0720	●	●
7,30			91	53	43	36	1,4	8	.0730	●	●
7,40			91	53	43	36	1,4	8	.0740	●	●
7,45		M8	91	53	43	36	1,4	8	.0745	●	●
7,50	M8x0,5		91	53	43	36	1,4	8	.0750	●	●
7,60		M8x1	91	53	43	36	1,4	8	.0760	●	●
7,70		M8x0,75	91	53	43	36	1,5	8	.0770	●	●
7,80	M9	M8x0,5	91	53	43	36	1,5	8	.0780	●	●
7,90	MJ9x1,25		91	53	43	36	1,5	8	.0790	●	●
8,00	M9x1		91	53	43	36	1,5	8	.0800	●	●
8,10	MJ9x1		103	61	49	40	1,5	10	.0810	●	●
8,20	M9x0,75		103	61	49	40	1,5	10	.0820	●	●
8,30			103	61	49	40	1,6	10	.0830	●	●
8,40			103	61	49	40	1,6	10	.0840	●	●
8,45		M9	103	61	49	40	1,6	10	.0845	●	●
8,50	M10 / M9x0,5		103	61	49	40	1,6	10	.0850	●	●
8,60	MJ10x1,5	M9x1	103	61	49	40	1,6	10	.0860	●	●
8,70		M9x0,75	103	61	49	40	1,6	10	.0870	●	●
8,80	M10x1,25	M9x0,5	103	61	49	40	1,7	10	.0880	●	●
8,90	MJ10x1,25		103	61	49	40	1,7	10	.0890	●	●
9,00	M10x1		103	61	49	40	1,7	10	.0900	●	●
9,10	MJ10x1		103	61	49	40	1,7	10	.0910	●	●
9,20	M10x0,75		103	61	49	40	1,7	10	.0920	●	●
9,30			103	61	49	40	1,7	10	.0930	●	●
9,35	MJ10x0,75	M10	103	61	49	40	1,8	10	.0935	●	●
9,40			103	61	49	40	1,8	10	.0940	●	●
9,45		M10x1,25	103	61	49	40	1,8	10	.0945	●	●

● = Lagerwerkzeug, siehe Preisliste · Stock tool, see price list
○ = Kurzfristig lieferbar, Preis auf Anfrage · Available on short notice, price upon inquiry

ø 9,50 mm - ø 20,00 mm

- Product Finder
- v_c / f
- STEEL
- VA
- GG
- HCUT
- Zubehör
Accessories
- Tech. Info

Für die Bearbeitung von nichtrostenden Stahlwerkstoffen
For the machining of stainless steel materials

VHM

ALCR
T37

DIN
6537 L

R30

Z2

2FF

140°

IT9-IT10

DIN 6535

HA

HE

VA
Stainless steel
materials

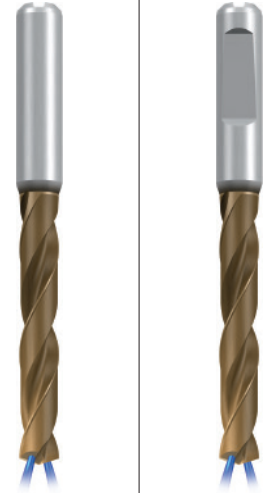

Lange Ausführung
Long design

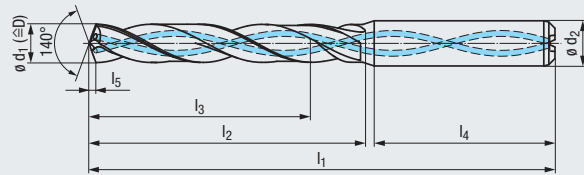

Bohrtiefe
Drill depth

5 x D

Einsatzgebiete – Material
Applications – material

M 1.1-4.1 **S 1.1-3** **S 2.2, 2.4, 2.6**

Werkzeug-Ident · Tool ident

TA214524

TA514524

$\varnothing d_1$ m7	Gewindebohrer Taps	Gewindeformer Cold-forming taps						$\varnothing d_2$ h6	Dimens.- Ident	EF-Drill-VA DIN6537L-HA IK-2FF ALCR-T37	EF-Drill-VA DIN6537L-HE IK-2FF ALCR-T37
			l_1	l_2	l_3	l_4	l_5				
9,50	M11 / M10x0,5		103	61	49	40	1,8	10	.0950	●	●
9,60	MJ10x0,5 / MJ11x1,5	M10x1	103	61	49	40	1,8	10	.0960	●	●
9,70		M10x0,75	103	61	49	40	1,8	10	.0970	●	●
9,80		M10x0,5	103	61	49	40	1,8	10	.0980	●	●
9,90	MJ11x1,25		103	61	49	40	1,9	10	.0990	●	●
10,00	M11x1		103	61	49	40	1,9	10	.1000	●	●
10,10	MJ11x1		118	71	56	45	1,9	12	.1010	●	●
10,20	M12 / M11x0,75		118	71	56	45	1,9	12	.1020	●	●
10,30			118	71	56	45	1,9	12	.1030	●	●
10,35	MJ11x0,75	M11	118	71	56	45	1,9	12	.1035	●	●
10,40			118	71	56	45	1,9	12	.1040	●	●
10,50	M12x1,5		118	71	56	45	2,0	12	.1050	●	●
10,60	MJ12x1,5	M11x1	118	71	56	45	2,0	12	.1060	●	●
10,70		M11x0,75	118	71	56	45	2,0	12	.1070	●	●
10,80	M12x1,25		118	71	56	45	2,0	12	.1080	●	●
10,90	MJ12x1,25		118	71	56	45	2,0	12	.1090	●	●
11,00	M12x1		118	71	56	45	2,1	12	.1100	●	●
11,10	MJ12x1		118	71	56	45	2,1	12	.1110	●	●
11,20	M12x0,75		118	71	56	45	2,1	12	.1120	●	●
11,25		M12	118	71	56	45	2,1	12	.1125	●	●
11,30			118	71	56	45	2,1	12	.1130	●	●
11,35		M12x1,5	118	71	56	45	2,1	12	.1135	●	●
11,40			118	71	56	45	2,1	12	.1140	●	●
11,45		M12x1,25	118	71	56	45	2,1	12	.1145	●	●
11,50			118	71	56	45	2,1	12	.1150	●	●
11,60		M12x1	118	71	56	45	2,2	12	.1160	●	●
11,70		M12x0,75	118	71	56	45	2,2	12	.1170	●	●
11,80			118	71	56	45	2,2	12	.1180	●	●
11,90			118	71	56	45	2,2	12	.1190	●	●
12,00	M14		118	71	56	45	2,2	12	.1200	●	●
12,20			124	77	60	45	2,3	14	.1220	●	●
12,30			124	77	60	45	2,3	14	.1230	●	●
12,50	M14x1,5		124	77	60	45	2,3	14	.1250	●	●
12,60	MJ14x1,5	M13x1	124	77	60	45	2,3	14	.1260	●	●
12,70		M13x0,75	124	77	60	45	2,4	14	.1270	●	●
12,80	M14x1,25		124	77	60	45	2,4	14	.1280	●	●
12,90	MJ14x1,25		124	77	60	45	2,4	14	.1290	●	●
13,00	M14x1		124	77	60	45	2,4	14	.1300	●	●
13,10	MJ14x1	M14	124	77	60	45	2,4	14	.1310	●	●
13,20	M14x0,75		124	77	60	45	2,5	14	.1320	●	●
13,30			124	77	60	45	2,5	14	.1330	●	●
13,35		M14x1,5	124	77	60	45	2,5	14	.1335	●	●
13,45		M14x1,25	124	77	60	45	2,5	14	.1345	●	●

Für die Bearbeitung von nichtrostenden Stahlwerkstoffen
For the machining of stainless steel materials

VHM **ALCR T37**

DIN 6537 L **R30**

Z2 **2FF**

140° **IT9-IT10**

DIN 6535
HA HE

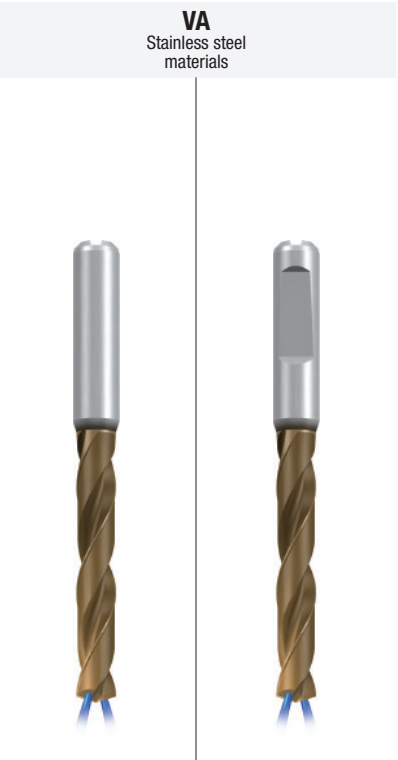

- Product Finder
- v_c / f
- STEEL
- VA
- GG
- HCUT
- Zubehör Accessories
- Tech. Info

Lange Ausführung
Long design

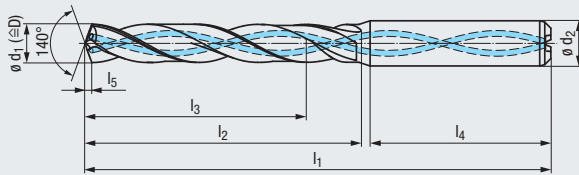

Bohrtiefe
Drill depth

5 x D

Einsatzgebiete – Material
Applications – material 510

M 1.1-4.1 **S 1.1-3** **S 2.2,2.4,2.6**

Werkzeug-Ident · Tool ident

ø d ₁ m7	Gewindebohrer Taps	Gewindeformer Cold-forming taps	l ₁	l ₂	l ₃	l ₄	l ₅	ø d ₂ h6	Dimens.- Ident	TA214524	TA514524
										EF-Drill-VA DIN6537L-HA IK-2FF ALCR-T37	EF-Drill-VA DIN6537L-HE IK-2FF ALCR-T37
13,50			124	77	60	45	2,5	14	.1350	●	●
13,60	MJ15x1,5	M14x1	124	77	60	45	2,5	14	.1360	●	●
13,70		M14x0,75	124	77	60	45	2,5	14	.1370	●	●
13,80			124	77	60	45	2,6	14	.1380	●	●
14,00	M16 / M15x1		124	77	60	45	2,6	14	.1400	●	●
14,10	MJ15x1		133	83	63	48	2,6	16	.1410	●	●
14,30			133	83	63	48	2,7	16	.1430	●	●
14,40			133	83	63	48	2,7	16	.1440	●	●
14,50	M16x1,5		133	83	63	48	2,7	16	.1450	●	●
14,60	MJ16x1,5	M15x1	133	83	63	48	2,7	16	.1460	●	●
14,70		M15x0,75	133	83	63	48	2,7	16	.1470	●	●
14,80			133	83	63	48	2,7	16	.1480	●	●
15,00	M16x1		133	83	63	48	2,8	16	.1500	●	●
15,10	MJ16x1	M16	133	83	63	48	2,8	16	.1510	●	●
15,35		M16x1,5	133	83	63	48	2,8	16	.1535	●	●
15,50	M18		133	83	63	48	2,9	16	.1550	●	●
15,60		M16x1	133	83	63	48	2,9	16	.1560	●	●
16,00	M18x2		133	83	63	48	3,0	16	.1600	●	●
16,50	M18x1,5		143	93	71	48	3,1	18	.1650	●	●
17,00	M18x1		143	93	71	48	3,1	18	.1700	●	●
17,50	M20		143	93	71	48	3,2	18	.1750	●	●
17,60		M18x1	143	93	71	48	3,3	18	.1760	●	●
18,00	M20x2		143	93	71	48	3,3	18	.1800	●	●
18,50	M20x1,5		153	101	77	50	3,4	20	.1850	●	●
18,85		M20	153	101	77	50	3,5	20	.1885	●	●
19,00	M20x1		153	101	77	50	3,5	20	.1900	●	●
19,35		M20x1,5	153	101	77	50	3,6	20	.1935	●	●
19,50	M22		153	101	77	50	3,6	20	.1950	●	●
19,60		M20x1	153	101	77	50	3,6	20	.1960	●	●
20,00	M22x2		153	101	77	50	3,7	20	.2000	●	●

- 3 x D
- 5 x D
- 6 x D
- 8 x D
- 2-3,5 x D



- Product Finder
- v_c / f
- STEEL
- VA
- GG
- HCUT
- Zubehör
Accessories
- Tech. Info

Für die Bearbeitung von Gusswerkstoffen
For the machining of cast materials

VHM

ALCR
T2

DIN
6537 L

R30

Z2

4FF

140°

IT9-IT10

DIN 6535

HA

HE

GG
Cast iron

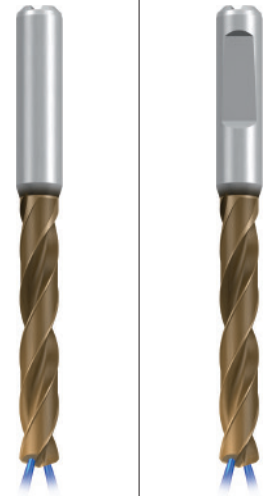

Lange Ausführung
Long design

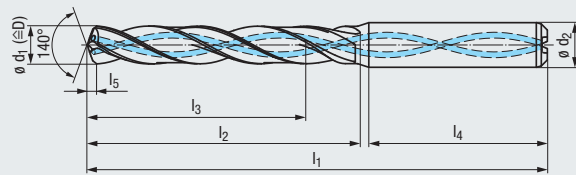

Bohrtiefe
Drill depth

5 x D

Einsatzgebiete – Material
Applications – material » 510

K 1.1-4.2

Werkzeug-Ident · Tool ident

TA212444

TA512444

$\emptyset d_1$ m7	Gewindebohrer Taps	Gewindeformer Cold-forming taps						$\emptyset d_2$ h6	Dimens.- Ident	EF-Drill-GG DIN6537L-HA IK-4FF ALCR-T2	EF-Drill-GG DIN6537L-HE IK-4FF ALCR-T2
			l_1	l_2	l_3	l_4	l_5				
2,80		M3	61	22	17	36	0,7	6	.0280	●	●
2,85			61	22	17	36	0,7	6	.0285	●	●
2,90	M3,5	M3x0,25	61	22	17	36	0,8	6	.0290	●	●
3,00	M3,5x0,5 / MJ3,5x0,6		66	28	23	36	0,8	6	.0300	●	●
3,10			66	28	23	36	0,8	6	.0310	●	●
3,15	M3,5x0,35		66	28	23	36	0,8	6	.0315	●	●
3,20	MJ3,5x0,35		66	28	23	36	0,8	6	.0320	●	●
3,25		M3,5	66	28	23	36	0,8	6	.0325	●	●
3,30	M4	M3,5x0,5	66	28	23	36	0,9	6	.0330	●	●
3,35			66	28	23	36	0,9	6	.0335	●	●
3,38		M3,5x0,35	66	28	23	36	0,9	6	.0338	●	●
3,40	MJ4x0,7		66	28	23	36	0,9	6	.0340	●	●
3,50	M4x0,5		66	28	23	36	0,9	6	.0350	●	●
3,55			66	28	23	36	0,9	6	.0355	●	●
3,60	MJ4x0,5		66	28	23	36	0,9	6	.0360	●	●
3,65	M4x0,35		66	28	23	36	0,9	6	.0365	●	●
3,70	M4,5	M4	66	28	23	36	1,0	6	.0370	●	●
3,80		M4x0,5	74	36	29	36	1,0	6	.0380	●	●
3,88		M4x0,35	74	36	29	36	1,0	6	.0388	●	●
3,90	MJ4,5x0,75		74	36	29	36	1,0	6	.0390	●	●
4,00			74	36	29	36	1,0	6	.0400	●	●
4,10	MJ4,5x0,5		74	36	29	36	1,1	6	.0410	●	●
4,15	M5x0,9		74	36	29	36	1,1	6	.0415	●	●
4,20	M5 / M5x0,75	M4,5	74	36	29	36	1,1	6	.0420	●	●
4,30	MJ5x0,8	M4,5x0,5	74	36	29	36	1,1	6	.0430	●	●
4,35			74	36	29	36	1,1	6	.0435	●	●
4,40			74	36	29	36	1,1	6	.0440	●	●
4,45			74	36	29	36	1,1	6	.0445	●	●
4,50	M5x0,5		74	36	29	36	1,2	6	.0450	●	●
4,60	M5,5 / MJ5x0,5		74	36	29	36	1,2	6	.0460	●	●
4,65		M5	74	36	29	36	1,2	6	.0465	●	●
4,70		M5x0,75	74	36	29	36	1,2	6	.0470	●	●
4,80		M5x0,5	82	44	35	36	1,2	6	.0480	●	●
4,90			82	44	35	36	1,3	6	.0490	●	●
5,00	M6		82	44	35	36	1,3	6	.0500	●	●
5,10	MJ6x1	M5,5	82	44	35	36	1,3	6	.0510	●	●
5,20	M6x0,75		82	44	35	36	1,3	6	.0520	●	●
5,25			82	44	35	36	1,3	6	.0525	●	●
5,30		M5,5x0,5	82	44	35	36	1,4	6	.0530	●	●
5,40			82	44	35	36	1,4	6	.0540	●	●
5,50	M6x0,5		82	44	35	36	1,4	6	.0550	●	●
5,55			82	44	35	36	1,4	6	.0555	●	●
5,60	MJ6x0,5	M6	82	44	35	36	1,4	6	.0560	●	●

Für die Bearbeitung von Gusswerkstoffen
For the machining of cast materials

VHM ALCR T2
DIN 6537 L R30
Z2 4FF
140° IT9-IT10
DIN 6535
HA HE

GG
Cast iron

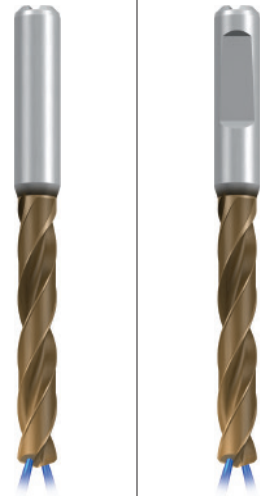

Lange Ausführung
Long design

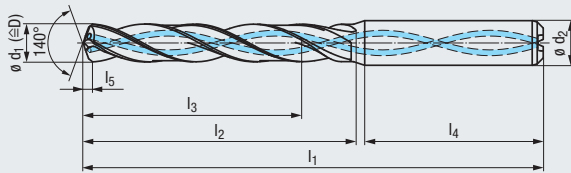

Bohrtiefe
Drill depth

5 x D

Einsatzgebiete – Material
Applications – material 510

K 1.1-4.2

Werkzeug-Ident · Tool ident

Ø d ₁ m7	Gewindebohrer Taps	Gewindeformer Cold-forming taps						Ø d ₂ h6	Dimens.- Ident	TA212444	TA512444
			l ₁	l ₂	l ₃	l ₄	l ₅			EF-Drill-GG DIN6537L-HA IK-4FF ALCR-T2	EF-Drill-GG DIN6537L-HE IK-4FF ALCR-T2
5,70		M6x0,75	82	44	35	36	1,4	6	.0570	●	●
5,80		M6x0,5	82	44	35	36	1,5	6	.0580	●	●
5,90			82	44	35	36	1,5	6	.0590	●	●
6,00	M7		82	44	35	36	1,5	6	.0600	●	●
6,10	MJ7x1		91	53	43	36	1,5	8	.0610	●	●
6,20	M7x0,75		91	53	43	36	1,6	8	.0620	●	●
6,30			91	53	43	36	1,6	8	.0630	●	●
6,35	MJ7x0,75		91	53	43	36	1,6	8	.0635	●	●
6,40			91	53	43	36	1,6	8	.0640	●	●
6,50	M7x0,5		91	53	43	36	1,6	8	.0650	●	●
6,60		M7	91	53	43	36	1,7	8	.0660	●	●
6,70		M7x0,75	91	53	43	36	1,7	8	.0670	●	●
6,80	M8	M7x0,5	91	53	43	36	1,7	8	.0680	●	●
6,90	MJ8x1,25		91	53	43	36	1,7	8	.0690	●	●
7,00	M8x1		91	53	43	36	1,8	8	.0700	●	●
7,10	MJ8x1		91	53	43	36	1,8	8	.0710	●	●
7,20	M8x0,75		91	53	43	36	1,8	8	.0720	●	●
7,30			91	53	43	36	1,8	8	.0730	●	●
7,40			91	53	43	36	1,9	8	.0740	●	●
7,45		M8	91	53	43	36	1,9	8	.0745	●	●
7,50	M8x0,5		91	53	43	36	1,9	8	.0750	●	●
7,60		M8x1	91	53	43	36	1,9	8	.0760	●	●
7,70		M8x0,75	91	53	43	36	1,9	8	.0770	●	●
7,80	M9	M8x0,5	91	53	43	36	2,0	8	.0780	●	●
7,90	MJ9x1,25		91	53	43	36	2,0	8	.0790	●	●
8,00	M9x1		91	53	43	36	2,0	8	.0800	●	●
8,10	MJ9x1		103	61	49	40	2,0	10	.0810	●	●
8,20	M9x0,75		103	61	49	40	2,1	10	.0820	●	●
8,30			103	61	49	40	2,1	10	.0830	●	●
8,40			103	61	49	40	2,1	10	.0840	●	●
8,45		M9	103	61	49	40	2,1	10	.0845	●	●
8,50	M10 / M9x0,5		103	61	49	40	2,1	10	.0850	●	●
8,60	MJ10x1,5	M9x1	103	61	49	40	2,2	10	.0860	●	●
8,70		M9x0,75	103	61	49	40	2,2	10	.0870	●	●
8,80	M10x1,25	M9x0,5	103	61	49	40	2,2	10	.0880	●	●
8,90	MJ10x1,25		103	61	49	40	2,2	10	.0890	●	●
9,00	M10x1		103	61	49	40	2,3	10	.0900	●	●
9,10	MJ10x1		103	61	49	40	2,3	10	.0910	●	●
9,20	M10x0,75		103	61	49	40	2,3	10	.0920	●	●
9,30			103	61	49	40	2,3	10	.0930	●	●
9,35	MJ10x0,75	M10	103	61	49	40	2,3	10	.0935	●	●
9,40			103	61	49	40	2,4	10	.0940	●	●
9,45		M10x1,25	103	61	49	40	2,4	10	.0945	●	●

● = Lagerwerkzeug, siehe Preisliste · Stock tool, see price list
○ = Kurzfristig lieferbar, Preis auf Anfrage · Available on short notice, price upon inquiry

Ø 9,50 mm - Ø 20,00 mm

- Product Finder
- v_c / f
- STEEL
- VA
- GG
- HCUT
- Zubehör
Accessories
- Tech. Info

- 3 x D
- 5 x D
- 6 x D
- 8 x D
- 2-3,5 x D



- Product Finder
- v_c / f
- STEEL
- VA
- GG
- HCUT
- Zubehör
Accessories
- Tech. Info

Für die Bearbeitung von Gusswerkstoffen
For the machining of cast materials

VHM

ALCR
T2

DIN
6537 L

R30

Z2

4FF

140°

IT9-IT10

DIN 6535

HA

HE

GG
Cast iron

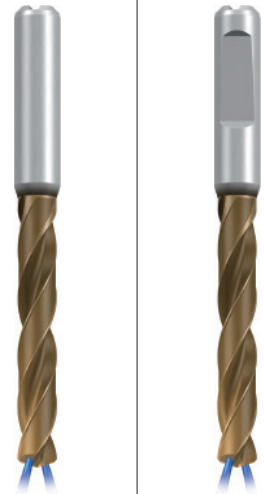

Lange Ausführung
Long design

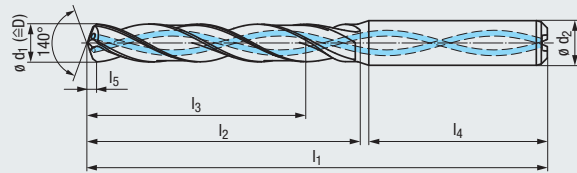

Bohrtiefe
Drill depth

5 x D

Einsatzgebiete – Material
Applications – material » 510

K 1.1-4.2

Werkzeug-Ident · Tool ident

TA212444

TA512444

$\emptyset d_1$ m7	Gewindebohrer Taps	Gewindeformer Cold-forming taps						$\emptyset d_2$ h6	Dimens.- Ident	EF-Drill-GG DIN6537L-HA IK-4FF ALCR-T2	EF-Drill-GG DIN6537L-HE IK-4FF ALCR-T2
			l_1	l_2	l_3	l_4	l_5			TA212444	TA512444
9,50	M11 / M10x0,5		103	61	49	40	2,4	10	.0950	●	●
9,60	MJ10x0,5 / MJ11x1,5	M10x1	103	61	49	40	2,4	10	.0960	●	●
9,70		M10x0,75	103	61	49	40	2,4	10	.0970	●	●
9,80		M10x0,5	103	61	49	40	2,5	10	.0980	●	●
9,90	MJ11x1,25		103	61	49	40	2,5	10	.0990	●	●
10,00	M11x1		103	61	49	40	2,5	10	.1000	●	●
10,10	MJ11x1		118	71	56	45	2,5	12	.1010	●	●
10,20	M12 / M11x0,75		118	71	56	45	2,6	12	.1020	●	●
10,30			118	71	56	45	2,6	12	.1030	●	●
10,35	MJ11x0,75	M11	118	71	56	45	2,6	12	.1035	●	●
10,40			118	71	56	45	2,6	12	.1040	●	●
10,50	M12x1,5		118	71	56	45	2,6	12	.1050	●	●
10,60	MJ12x1,5	M11x1	118	71	56	45	2,7	12	.1060	●	●
10,70		M11x0,75	118	71	56	45	2,7	12	.1070	●	●
10,80	M12x1,25		118	71	56	45	2,7	12	.1080	●	●
10,90	MJ12x1,25		118	71	56	45	2,7	12	.1090	●	●
11,00	M12x1		118	71	56	45	2,8	12	.1100	●	●
11,10	MJ12x1		118	71	56	45	2,8	12	.1110	●	●
11,20	M12x0,75		118	71	56	45	2,8	12	.1120	●	●
11,25		M12	118	71	56	45	2,8	12	.1125	●	●
11,30			118	71	56	45	2,8	12	.1130	●	●
11,35		M12x1,5	118	71	56	45	2,8	12	.1135	●	●
11,40			118	71	56	45	2,8	12	.1140	●	●
11,45		M12x1,25	118	71	56	45	2,9	12	.1145	●	●
11,50			118	71	56	45	2,9	12	.1150	●	●
11,60		M12x1	118	71	56	45	2,9	12	.1160	●	●
11,70		M12x0,75	118	71	56	45	2,9	12	.1170	●	●
11,80			118	71	56	45	2,9	12	.1180	●	●
11,90			118	71	56	45	3,0	12	.1190	●	●
12,00	M14		118	71	56	45	3,0	12	.1200	●	●
12,20			124	77	60	45	3,0	14	.1220	●	●
12,30			124	77	60	45	3,1	14	.1230	●	●
12,50	M14x1,5		124	77	60	45	3,1	14	.1250	●	●
12,60	MJ14x1,5	M13x1	124	77	60	45	3,1	14	.1260	●	●
12,70		M13x0,75	124	77	60	45	3,2	14	.1270	●	●
12,80	M14x1,25		124	77	60	45	3,2	14	.1280	●	●
12,90	MJ14x1,25		124	77	60	45	3,2	14	.1290	●	●
13,00	M14x1		124	77	60	45	3,2	14	.1300	●	●
13,10	MJ14x1	M14	124	77	60	45	3,3	14	.1310	●	●
13,20	M14x0,75		124	77	60	45	3,3	14	.1320	●	●
13,30			124	77	60	45	3,3	14	.1330	●	●
13,35		M14x1,5	124	77	60	45	3,3	14	.1335	●	●
13,45		M14x1,25	124	77	60	45	3,4	14	.1345	●	●

Für die Bearbeitung von Gusswerkstoffen
For the machining of cast materials

VHM ALCR T2
 DIN 6537 L R30
 Z2 4FF
 140° IT9-IT10
 DIN 6535
 HA HE

GG
Cast iron

Lange Ausführung
Long design

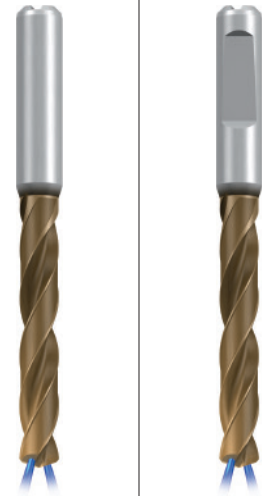
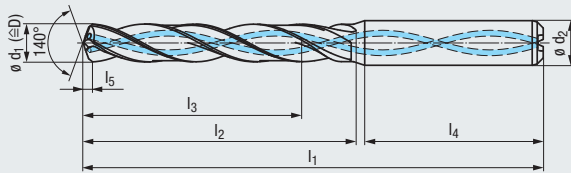

- Product Finder
- v_c / f
- STEEL
- VA
- GG**
- HCUT
- Zubehör
Accessories
- Tech. Info

Bohrtiefe
Drill depth

5 x D

Einsatzgebiete – Material
Applications – material » 510

K 1.1-4.2

Werkzeug-Ident · Tool ident

ø d ₁ m7	Gewindebohrer Taps	Gewindeformer Cold-forming taps						ø d ₂ h6	Dimens.- Ident	TA212444	TA512444
			l ₁	l ₂	l ₃	l ₄	l ₅			EF-Drill-GG DIN6537L-HA IK-4FF ALCR-T2	EF-Drill-GG DIN6537L-HE IK-4FF ALCR-T2
13,50			124	77	60	45	3,4	14	.1350	●	●
13,60	MJ15x1,5	M14x1	124	77	60	45	3,4	14	.1360	●	●
13,70		M14x0,75	124	77	60	45	3,4	14	.1370	●	●
13,80			124	77	60	45	3,4	14	.1380	●	●
14,00	M16 / M15x1		124	77	60	45	3,5	14	.1400	●	●
14,10	MJ15x1		133	83	63	48	3,5	16	.1410	●	●
14,30			133	83	63	48	3,6	16	.1430	●	●
14,40			133	83	63	48	3,6	16	.1440	●	●
14,50	M16x1,5		133	83	63	48	3,6	16	.1450	●	●
14,60	MJ16x1,5	M15x1	133	83	63	48	3,6	16	.1460	●	●
14,70		M15x0,75	133	83	63	48	3,7	16	.1470	●	●
14,80			133	83	63	48	3,7	16	.1480	●	●
15,00	M16x1		133	83	63	48	3,7	16	.1500	●	●
15,10	MJ16x1	M16	133	83	63	48	3,8	16	.1510	●	●
15,35		M16x1,5	133	83	63	48	3,8	16	.1535	●	●
15,50	M18		133	83	63	48	3,9	16	.1550	●	●
15,60		M16x1	133	83	63	48	3,9	16	.1560	●	●
16,00	M18x2		133	83	63	48	4,0	16	.1600	●	●
16,50	M18x1,5		143	93	71	48	4,1	18	.1650	●	●
17,00	M18x1		143	93	71	48	4,2	18	.1700	●	●
17,50	M20		143	93	71	48	4,3	18	.1750	●	●
17,60		M18x1	143	93	71	48	4,4	18	.1760	●	●
18,00	M20x2		143	93	71	48	4,5	18	.1800	●	●
18,50	M20x1,5		153	101	77	50	4,6	20	.1850	●	●
18,85		M20	153	101	77	50	4,7	20	.1885	●	●
19,00	M20x1		153	101	77	50	4,7	20	.1900	●	●
19,35		M20x1,5	153	101	77	50	4,8	20	.1935	●	●
19,50	M22		153	101	77	50	4,8	20	.1950	●	●
19,60		M20x1	153	101	77	50	4,9	20	.1960	●	●
20,00	M22x2		153	101	77	50	5,0	20	.2000	●	●

- 3 x D
- 5 x D**
- 6 x D
- 8 x D
- 2-3,5 x D



- Product Finder
- v_c / f
- STEEL
- VA
- GG
- HCUT
- Zubehör
Accessories
- Tech. Info

**Für die Bearbeitung von gehärteten Stählen
mit einer Härte von 50-67 HRC**
For the machining of hardened steels
with a hardness of 50-67 HRC

VHM

TIALN
T10

DIN
6537 K

R30

Z2

2FF

140°

IT9-IT10

DIN 6535

HA

new

HCUT
Hardened
steels

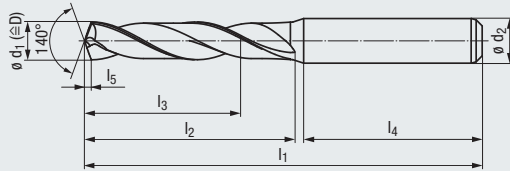

Bohrtiefe
Drill depth

3 x D

Einsatzgebiete – Material
Applications – material » 510

H 1.1-5

Werkzeug-Ident · Tool ident

TA107725

- 3 x D
- 5 x D
- 6 x D
- 8 x D
- 2-3,5 x D

Ø d ₁ m7	Gewindebohrer Taps HCUT	l ₁	l ₂	l ₃	l ₄	l ₅	Ø d ₂ h6	Dimens.- Ident	EF-Drill-HCUT DIN6537K-HA AK-2FF TIALN-T10
2,55	M3	57	16	11	36	0,5	6	.0255	●
3,00		62	20	14	36	0,6	6	.0300	●
3,40	M4	62	20	14	36	0,7	6	.0340	●
3,50		62	20	14	36	0,7	6	.0350	●
4,00		66	24	17	36	0,8	6	.0400	●
4,30	M5	66	24	17	36	0,8	6	.0430	●
4,50		66	24	17	36	0,9	6	.0450	●
5,00		66	28	20	36	1,0	6	.0500	●
5,10	M6	66	28	20	36	1,0	6	.0510	●
5,50		66	28	20	36	1,1	6	.0550	●
6,00		66	28	20	36	1,1	6	.0600	●
6,50		79	34	24	36	1,2	8	.0650	●
6,90	M8	79	34	24	36	1,3	8	.0690	●
7,00		79	34	24	36	1,3	8	.0700	●
7,10	M8 x 1	79	41	29	36	1,3	8	.0710	●
7,50		79	41	29	36	1,4	8	.0750	●
8,00		79	41	29	36	1,5	8	.0800	●
8,50		89	47	35	40	1,6	10	.0850	●
8,60	M10	89	47	35	40	1,6	10	.0860	●
8,80	G 1/8	89	47	35	40	1,7	10	.0880	●
9,00		89	47	35	40	1,7	10	.0900	●
9,10	M10 x 1	89	47	35	40	1,7	10	.0910	●
9,50		89	47	35	40	1,8	10	.0950	●
10,00		89	47	35	40	1,9	10	.1000	●
10,40	M12	102	55	40	45	1,9	12	.1040	●
10,50		102	55	40	45	2,0	12	.1050	●
10,60	M12 x 1,5	102	55	40	45	2,0	12	.1060	●
11,00		102	55	40	45	2,1	12	.1100	●
11,50		102	55	40	45	2,1	12	.1150	●
11,90	G 1/4	102	55	40	45	2,2	12	.1190	●
12,00		102	55	40	45	2,2	12	.1200	●
12,60	M14 x 1,5	107	60	43	45	2,3	14	.1260	●
14,20	M16	115	65	45	48	2,6	16	.1420	●
14,60	M16 x 1,5	115	65	45	48	2,7	16	.1460	●



Spannzangen-Aufnahmen
Typ KSN/Synchro
siehe Seite 711 - 713

Collet holders
type KSN/Synchro,
see page 711 - 713

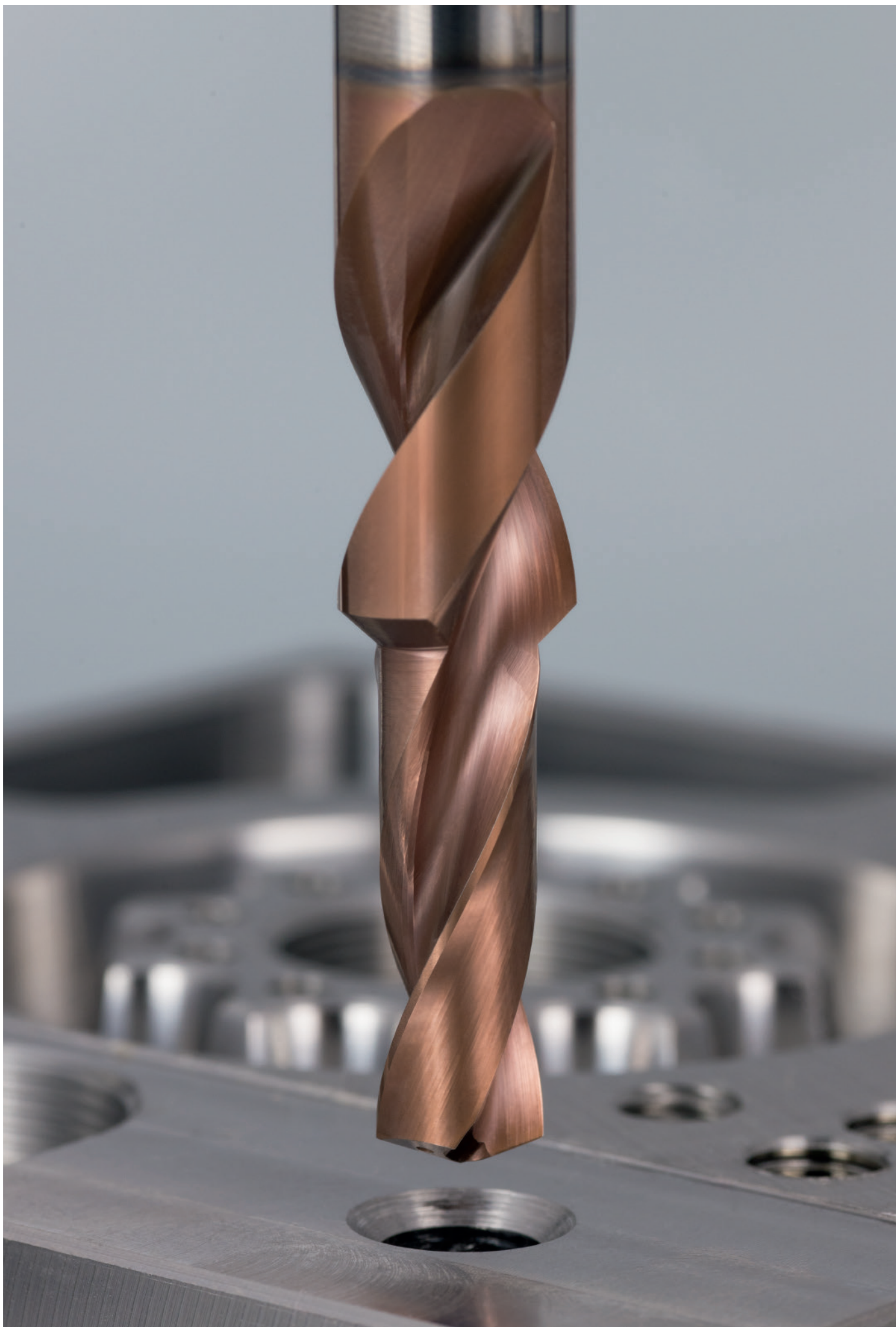
Product
Finder v_c / f

STEEL

VA

GG

HCUT

Zubehör
Accessories

Tech. Info

3 x D

5 x D

6 x D

8 x D

2-3,5 x D



- Product Finder
- v_c / f
- STEEL
- VA
- GG
- HCUT
- Zubehör Accessories
- Tech. Info

Variable Stufenlängen in mm-Schritten
Variable step length in millimeter steps

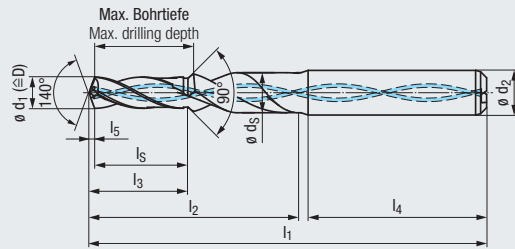

VHM

TIALN T14

≈ DIN 6537 K

Z2

4FF

140°

IT8-IT10

DIN 6535

HA

STEEL
Steel materials



Bohrtiefe
Drill depth

2 - 3,5 x D

Einsatzgebiete – Material
Applications – material » 510

P 1.1-5.1	M 1.1
K 1.1-4.2	N 1.1-5
N 2.1-8	H 1.1-2

Werkzeug-Ident · Tool ident

TG203344

ϕd_1 m7	Gewindebohrer Taps	Gewindeformer Cold-forming taps				l_3		l_5		ϕd_2 h6	Dimens.- Ident	EF-Drill C-STEEL HA IK-4FF TIALN-T14				
			ϕd_s	l_1	l_2	2 x D min.	3,5 x D max.	l_4	l_5				2 x D min.	3,5 x D max.		
2,80		M3	4	57	17	6,6	-	10,6	36	0,6	6	-	10	6	.028006 - .028010	●
2,90	M3,5		4	57	18	6,6	-	10,6	36	0,6	6	-	10	6	.029006 - .029010	●
3,25		M3,5	5	62	24	7,7	-	11,7	36	0,6	7	-	11	6	.032507 - .032511	●
3,30	M4	M3,5 x 0,5	5	62	24	7,7	-	12,7	36	0,7	7	-	12	6	.033007 - .033012	●
3,70	M4,5		5	62	24	7,8	-	13,8	36	0,7	7	-	13	6	.037007 - .037013	●
4,20	M5, M5 x 0,75	M4,5	6	66	29	8,9	-	15,9	36	0,8	8	-	15	6	.042008 - .042015	●
4,65		M5	6	66	29	9,9	-	16,9	36	0,9	9	-	16	6	.046509 - .046516	●
5,00	M6		7	79	40	11,0	-	19,0	36	1,0	10	-	18	8	.050010 - .050018	●
5,60	MJ6 x 0,5	M6	7	79	40	12,1	-	21,1	36	1,1	11	-	20	8	.056011 - .056020	●
6,00	M7		8	79	42	13,2	-	22,2	36	1,1	12	-	21	8	.060012 - .060021	●
6,60		M7	8	89	45	14,3	-	24,3	40	1,3	13	-	23	10	.066013 - .066023	●
6,80	M8	M7 x 0,5	9	89	46	15,4	-	25,4	40	1,3	14	-	24	10	.068014 - .068024	●
7,00	M8 x 1		9	89	46	15,4	-	26,4	40	1,3	14	-	25	10	.070014 - .070025	●
7,45		M8	9	89	46	16,5	-	27,5	40	1,4	15	-	26	10	.074515 - .074526	●
7,60		M8 x 1	9	89	46	16,5	-	28,5	40	1,4	15	-	27	10	.076015 - .076027	●
7,80	M9	M8 x 0,5	10	89	48	17,5	-	28,5	40	1,5	16	-	27	10	.078016 - .078027	●
8,45		M9	12	102	56	18,7	-	31,7	45	1,6	17	-	30	12	.084517 - .084530	●
8,50	M10, M9 x 0,5		12	102	56	18,7	-	31,7	45	1,6	17	-	30	12	.085017 - .085030	●
9,00	M10 x 1		12	102	56	19,8	-	33,8	45	1,7	18	-	32	12	.090018 - .090032	●
9,35	MJ10 x 0,75	M10	12	102	56	20,8	-	34,8	45	1,8	19	-	33	12	.093519 - .093533	●
9,50	M11, M10 x 0,5		12	102	56	20,9	-	34,9	45	1,8	19	-	33	12	.095019 - .095033	●
9,60	MJ,10 x 0,5	M10x1	12	102	56	20,9	-	35,9	45	1,8	19	-	34	12	.096019 - .096034	●
10,20	M12, M11 x 0,75		14	107	61	22,0	-	38,0	45	1,9	20	-	36	14	.102020 - .102036	●
10,35	MJ11 x 0,75	M11	14	107	61	23,0	-	38,0	45	1,9	21	-	36	14	.103521 - .103536	●
10,50	M12 x 1,5		14	107	61	23,1	-	39,1	45	2,0	21	-	37	14	.105021 - .105037	●
11,25		M12	14	107	61	25,2	-	41,2	45	2,1	23	-	39	14	.112523 - .112539	●
11,35		M12 x 1,5	14	107	61	25,2	-	42,2	45	2,1	23	-	40	14	.113523 - .113540	●
12,00	M14		16	115	66	26,4	-	44,4	48	2,2	24	-	42	16	.120024 - .120042	●
12,50	M14 x 1,5		16	115	66	27,4	-	46,4	48	2,3	25	-	44	16	.125025 - .125044	●
13,10	MJ14 x 1	M14	16	115	66	28,6	-	48,6	48	2,4	26	-	46	16	.131026 - .131046	●
13,35		M14 x 1,5	16	115	66	29,6	-	49,6	48	2,5	27	-	47	16	.133527 - .133547	●
14,00	M16, M15 x 1		18	123	74	30,7	-	51,7	48	2,6	28	-	49	18	.140028 - .140049	●
14,50	M16 x 1,5		18	123	74	31,8	-	53,8	48	2,7	29	-	51	18	.145029 - .145051	●
15,10	MJ16 x 1	M16	18	123	74	32,9	-	55,9	48	2,8	30	-	53	18	.151030 - .151053	●
15,35		M16 x 1,5	18	123	74	34,0	-	57,0	48	2,8	31	-	54	18	.153531 - .153554	●
15,50	M18		20	131	80	34,0	-	57,0	50	2,9	31	-	54	20	.155031 - .155054	●

Bestell-Beispiel · Ordering example: **TG203344.0280 07**

Bohrdurchmesser $d_1 = 2,80$ mm · Drill diameter $d_1 = 2,80$ mm

Stufenlänge $l_5 = 7$ mm · Step length $l_5 = 7$ mm

Variable Stufenlängen in mm-Schritten
Variable step length in millimeter steps

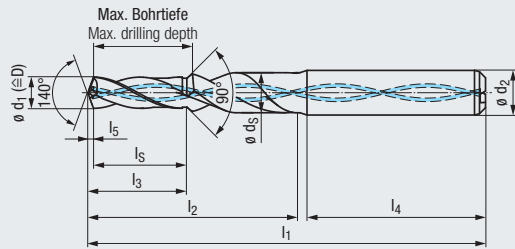

VHM ALCR T37

new

≈ DIN 6537 K

Z2 2FF

140° IT8-IT10

DIN 6535

HA

VA
Stainless steel materials



- Product Finder
- v_c / f
- STEEL
- VA
- GG
- HCUT
- Zubehör Accessories
- Tech. Info

Bohrtiefe
Drill depth

2 - 3,5 x D

Einsatzgebiete – Material
Applications – material

M 1.1-4.1 S 1.1-3

S 2.2, 2.4, 2.6 N 1.1-3

Werkzeug-Ident · Tool ident

TG204524

ø d ₁ m7	Gewindebohrer Taps	Gewindeformer Cold-forming taps	ø d _s		l ₃		l ₄		l _s		ø d ₂ h6	Dimens.- Ident	EF-Drill C-VA HA IK-2FF ALCR-T37
			l ₁	l ₂	2 x D min.	3,5 x D max.	l ₄	l ₅	2 x D min.	3,5 x D max.			
2,80		M3	4	57	17	6,6 - 10,6	36	0,6	6 - 10	6	.028006 - .028010	●	
2,90	M3,5	M3	4	57	18	6,6 - 10,6	36	0,6	6 - 10	6	.029006 - .029010	●	
3,25		M3,5	5	62	24	7,7 - 11,7	36	0,6	7 - 11	6	.032507 - .032511	●	
3,30	M4	M3,5 x 0,5	5	62	24	7,7 - 12,7	36	0,7	7 - 12	6	.033007 - .033012	●	
3,70	M4,5	M4	5	62	24	7,8 - 13,8	36	0,7	7 - 13	6	.037007 - .037013	●	
4,20	M5, M5 x 0,75	M4,5	6	66	29	8,9 - 15,9	36	0,8	8 - 15	6	.042008 - .042015	●	
4,65		M5	6	66	29	9,9 - 16,9	36	0,9	9 - 16	6	.046509 - .046516	●	
5,00	M6		7	79	40	11,0 - 19,0	36	1,0	10 - 18	8	.050010 - .050018	●	
5,60	MJ6 x 0,5	M6	7	79	40	12,1 - 21,1	36	1,1	11 - 20	8	.056011 - .056020	●	
6,00	M7		8	79	42	13,2 - 22,2	36	1,1	12 - 21	8	.060012 - .060021	●	
6,60		M7	8	89	45	14,3 - 24,3	40	1,3	13 - 23	10	.066013 - .066023	●	
6,80	M8	M7 x 0,5	9	89	46	15,4 - 25,4	40	1,3	14 - 24	10	.068014 - .068024	●	
7,00	M8 x 1		9	89	46	15,4 - 26,4	40	1,3	14 - 25	10	.070014 - .070025	●	
7,45		M8	9	89	46	16,5 - 27,5	40	1,4	15 - 26	10	.074515 - .074526	●	
7,60		M8 x 1	9	89	46	16,5 - 28,5	40	1,4	15 - 27	10	.076015 - .076027	●	
7,80	M9	M8 x 0,5	10	89	48	17,5 - 28,5	40	1,5	16 - 27	10	.078016 - .078027	●	
8,45		M9	12	102	56	18,7 - 31,7	45	1,6	17 - 30	12	.084517 - .084530	●	
8,50	M10, M9 x 0,5		12	102	56	18,7 - 31,7	45	1,6	17 - 30	12	.085017 - .085030	●	
9,00	M10 x 1		12	102	56	19,8 - 33,8	45	1,7	18 - 32	12	.090018 - .090032	●	
9,35	MJ10 x 0,75	M10	12	102	56	20,8 - 34,8	45	1,8	19 - 33	12	.093519 - .093533	●	
9,50	M11, M10 x 0,5		12	102	56	20,9 - 34,9	45	1,8	19 - 33	12	.095019 - .095033	●	
9,60	MJ,10 x 0,5	M10x1	12	102	56	20,9 - 35,9	45	1,8	19 - 34	12	.096019 - .096034	●	
10,20	M12, M11 x 0,75		14	107	61	22,0 - 38,0	45	1,9	20 - 36	14	.102020 - .102036	●	
10,35	MJ11 x 0,75	M11	14	107	61	23,0 - 38,0	45	1,9	21 - 36	14	.103521 - .103536	●	
10,50	M12 x 1,5		14	107	61	23,1 - 39,1	45	2,0	21 - 37	14	.105021 - .105037	●	
11,25		M12	14	107	61	25,2 - 41,2	45	2,1	23 - 39	14	.112523 - .112539	●	
11,35		M12 x 1,5	14	107	61	25,2 - 42,2	45	2,1	23 - 40	14	.113523 - .113540	●	
12,00	M14		16	115	66	26,4 - 44,4	48	2,2	24 - 42	16	.120024 - .120042	●	
12,50	M14 x 1,5		16	115	66	27,4 - 46,4	48	2,3	25 - 44	16	.125025 - .125044	●	
13,10	MJ14 x 1	M14	16	115	66	28,6 - 48,6	48	2,4	26 - 46	16	.131026 - .131046	●	
13,35		M14 x 1,5	16	115	66	29,6 - 49,6	48	2,5	27 - 47	16	.133527 - .133547	●	
14,00	M16, M15 x 1		18	123	74	30,7 - 51,7	48	2,6	28 - 49	18	.140028 - .140049	●	
14,50	M16 x 1,5		18	123	74	31,8 - 53,8	48	2,7	29 - 51	18	.145029 - .145051	●	
15,10	MJ16 x 1	M16	18	123	74	32,9 - 55,9	48	2,8	30 - 53	18	.151030 - .151053	●	
15,35		M16 x 1,5	18	123	74	34,0 - 57,0	48	2,8	31 - 54	18	.153531 - .153554	●	
15,50	M18		20	131	80	34,0 - 57,0	50	2,9	31 - 54	20	.155031 - .155054	●	

Bestell-Beispiel · Ordering example: **TG204524.0280 07**

Bohrdurchmesser d₁ = 2,80 mm · Drill diameter d₁ = 2,80 mm

Stufenlänge l_s = 7 mm · Step length l_s = 7 mm

- Product Finder
- v_c / f
- STEEL
- VA
- GG
- HCUT
- Zubehör
Accessories
- Tech. Info

Für Zylinderschäfte nach DIN 6535 HE
For straight shanks acc. DIN 6535 HE

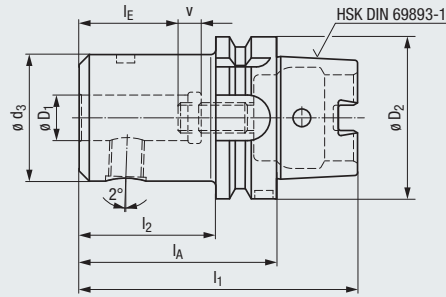

Werkzeug-Ident · Tool ident									TCWNHS63	
$\varnothing D_1$	$\varnothing d_3$	l_1	l_2	l_A	l_E	v	$\varnothing D_2$	Dimens.-Ident		
6	25	112	54	80	30	10	HSK-A63	.060800		●
8	28	112	54	80	30	10	HSK-A63	.080800		●
10	35	112	54	80	35	7	HSK-A63	.100800		●
12	42	122	64	90	40	7	HSK-A63	.120900		●
14	44	122	64	90	40	8	HSK-A63	.140900		●
16	48	132	74	100	43	10	HSK-A63	.161000		●
18	50	132	74	100	43	10	HSK-A63	.181000		●
20	52	132	74	100	45	8	HSK-A63	.201000		●
25	65	142	84	110	50	9	HSK-A63	.251100		●
32	72	142	84	110	54	9	HSK-A63	.321100		●

- 3 x D
- 5 x D
- 6 x D
- 8 x D
- 2-3,5 x D



Kühlschmierstoffrohr und Schlüssel
Coolant tube and assembly wrench

» 782 - 783

Spannschrauben mit Innensechskant
Allen clamping screws



Werkzeug-Ident · Tool ident			TWA01001	
Für For $\varnothing D_1$	Größe Dimension	Dimens.-Ident		
6	M 6 x 10 x SW 3	.22010		●
8	M 8 x 10 x SW 4	.25010		●
10	M10 x 12 x SW 5	.27012		●
12 - 14	M12 x 16 x SW 6	.30016		●
16 - 18	M14 x 16 x SW 6	.33016		●
20	M16 x 16 x SW 8	.35016		●
25	M18 x 20 x SW 10	.39020		●
32	M20 x 20 x SW 10	.42020		●

T-Griff-Schraubendreher für Spannschrauben
T-handle wrench for clamping screws



Werkzeug-Ident · Tool ident			TWP03002	
Für For $\varnothing D_1$	Größe Dimension	Dimens.-Ident		
6	SW 3 x 100	.03010		●
8	SW 4 x 100	.04010		●
10	SW 5 x 150	.05015		●
12 - 16	SW 6 x 150	.06015		●
18 - 20	SW 8 x 150	.08015		●
25 - 32	SW10 x 200	.10020		●

Verstellschrauben mit Innensechskant
Allen adjusting screws



Werkzeug-Ident · Tool ident			TWA02001	
Für For $\varnothing D_1$	Größe Dimension	Dimens.-Ident		
6	M 5 x 16 x SW 2,5	.20016		●
8	M 6 x 16 x SW 3	.22016		●
10	M 8 x 16 x SW 4	.25016		●
12 - 14	M10 x 16 x SW 5	.27016		●
16 - 18	M12 x 16 x SW 6	.30016		●
20 - 32	M16 x 20 x SW 6	.35020		●

Winkelschraubendreher für Verstellschrauben
Allen wrench for adjusting screws



Werkzeug-Ident · Tool ident			TWP03001	
Für For $\varnothing D_1$	Größe Dimension	Dimens.-Ident		
6	SW 2,5	.02500		●
8	SW 3	.03000		●
10	SW 4	.04000		●
12 - 14	SW 5	.05000		●
16 - 32	SW 6	.06000		●

Für Zylinderschäfte nach DIN 6535 HE
For straight shanks acc. DIN 6535 HE

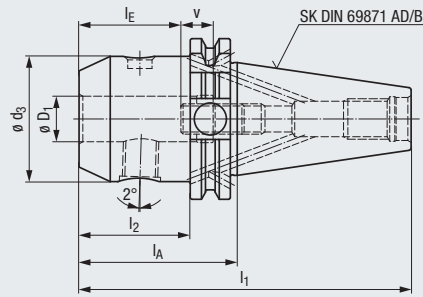

- Product Finder
- v_c / f
- STEEL
- VA
- GG
- HCUT
- Zubehör
Accessories
- Tech. Info

Werkzeug-Ident · Tool ident

TCWNSK40

ø D ₁	d ₃	l ₁	l ₂	l _A	l _E	v	SK	Dimens.-Ident
6	25	118	31	50	30	10	SK 40	.060500
8	28	118	31	50	30	10	SK 40	.080500
10	35	118	31	50	35	10	SK 40	.100500
12	42	118	31	50	40	10	SK 40	.120500
14	44	118	31	50	40	10	SK 40	.140500
16	48	131	44	63	43	10	SK 40	.160630
18	50	131	44	63	43	10	SK 40	.180630
20	52	131	44	63	45	10	SK 40	.200630
25	65	168	81	100	50	10	SK 40	.251000
32	72	168	81	100	54	10	SK 40	.321000

- 3 x D
- 5 x D
- 6 x D
- 8 x D
- 2-3,5 x D

Werkzeug-Ident · Tool ident

TCWNSK50

ø D ₁	d ₃	l ₁	l ₂	l _A	l _E	v	SK	Dimens.-Ident
6	25	165	44	63	30	10	SK 50	.060630
8	28	165	44	63	30	10	SK 50	.080630
10	35	165	44	63	35	10	SK 50	.100630
12	42	165	44	63	40	10	SK 50	.120630
14	44	165	44	63	40	10	SK 50	.140630
16	48	165	44	63	43	10	SK 50	.160630
18	50	165	44	63	43	10	SK 50	.180630
20	52	165	44	63	45	10	SK 50	.200630
25	65	182	61	80	50	10	SK 50	.250800
32	72	202	81	100	54	10	SK 50	.321000

Umstellschraube Innenkühlung
Internal coolant screw plug



Werkzeug-Ident · Tool ident

TWA04001

Für For	Größe Dimension	Dimens.-Ident
SK 40	M5 x 5 x SW 2,5	.20005
SK 50	M8 x 6 x SW 4	.25006



Anzugsbolzen für Steilkegel
Pull studs for ISO tapers

» 566



- Product Finder
- v_c / f
- STEEL
- VA
- GG
- HCUT
- Zubehör Accessories
- Tech. Info

Für Zylinderschäfte nach DIN 6535 HA
For straight shanks acc. DIN 6535 HA

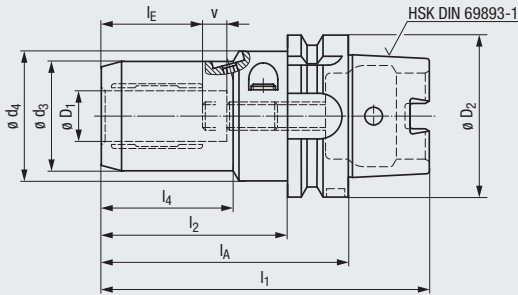

Mit Werkzeuglängeneinstellung (Betätigung radial)
With tool length adjustment (radial operation)



Werkzeug-Ident · Tool ident

TCHDHS63

$\varnothing D_1$	d_3	d_4	l_1	l_2	l_4	l_A	l_E	v	$\varnothing D_2$	Dimens.-Ident	
6	25,7	50	112	54	33	80	27	10	HSK-A63	.060800	●
8	27,7	50	112	54	34	80	27	10	HSK-A63	.080800	●
10	29,7	50	112	59	39	85	31	10	HSK-A63	.100850	●
12	31,6	50	122	64	45	90	36	10	HSK-A63	.120900	●
14	33,6	50	122	64	46	90	36	10	HSK-A63	.140900	●
16	37,6	50	132	69	52	95	39	10	HSK-A63	.160950	●
18	39,6	50	132	69	52	95	39	10	HSK-A63	.180950	●
20	41,6	50	132	74	58	100	41	10	HSK-A63	.201000	●
25	49,6	63	142	94	51	120	46	10	HSK-A63	.251200	●
32	59,8	63	142	99	59	125	50	10	HSK-A63	.321250	●

- 3 x D
- 5 x D
- 6 x D
- 8 x D
- 2-3,5 x D



Kühlschmierstoffrohr und Schlüssel
Coolant tube and assembly wrench

782 - 783

Spannschrauben mit Innensechskant Allen clamping screws



Werkzeug-Ident · Tool ident

TWA01002

Für For $\varnothing D_1$	Größe Dimension	Dimens.-Ident	
6 - 20	M10 x 12 x SW 5	.27012	●
25 - 32	M14 x 16 x SW 6	.33016	●

T-Griff-Schraubendreher für Spannschrauben T-handle wrench for clamping screws



Werkzeug-Ident · Tool ident

TWB03002

Für For $\varnothing D_1$	Größe Dimension	Dimens.-Ident	
6 - 20	SW 5 x 150	.05015	●
25 - 32	SW 6 x 150	.06015	●

Serviceleistungen

- Einbauteile des Spannsystems erneuern
- Radial-/Axialverstellung erneuern
- Dehnrate einstellen
- Drehmoment prüfen
- Rundlauf prüfen

Service options

- Replace spare parts of the clamping system
- Replace radial / axial adjustment
- Adjust expansion rate
- Check torque
- Check concentricity

Winkelschraubendreher für Verstellerschrauben Allen wrench for adjusting screws



Werkzeug-Ident · Tool ident

TWB03001

Für For $\varnothing D_1$	Größe Dimension	Dimens.-Ident	
6 - 12	SW 2,5	.02500	●
14 - 20	SW 3	.03000	●
25 - 32	SW 4	.04000	●

Für Zylinderschäfte nach DIN 6535 HA
For straight shanks acc. DIN 6535 HA

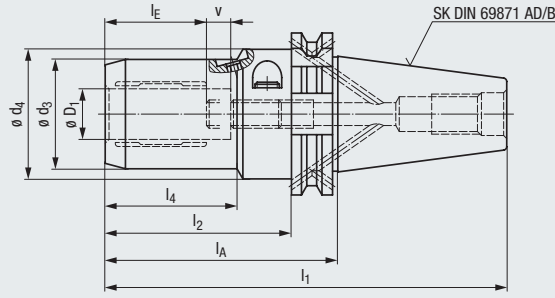

Mit Werkzeuglängeneinstellung
(Betätigung radial)
With tool length adjustment
(radial operation)



- Product Finder
- v_c / f
- STEEL
- VA
- GG
- HCUT
- Zubehör
Accessories
- Tech. Info

Werkzeug-Ident · Tool ident

TCHDSK40

ø D ₁	d ₃	d ₄	l ₁	l ₂	l ₄	l _A	l _E	v	SK	Dimens.-Ident
6	25,7	50	140	53	33	72	30	10	SK 40	.060720
8	27,7	50	140	53	34	72	30	10	SK 40	.080720
10	29,7	50	145	58	39	77	35	10	SK 40	.100770
12	31,6	50	145	58	40	77	35	10	SK 40	.120770
14	33,6	50	150	63	46	82	40	10	SK 40	.140820
16	37,6	50	150	63	47	82	40	10	SK 40	.160820
18	39,6	50	150	63	47	82	40	10	SK 40	.180820
20	41,6	50	150	63	48	82	40	10	SK 40	.200820
25	49,6	63	185	98	51	117	51	10	SK 40	.251170
32	59,9	63	185	98	59	117	51	10	SK 40	.321170

- 3 x D
- 5 x D
- 6 x D
- 8 x D
- 2-3,5 x D

Werkzeug-Ident · Tool ident

TCHDSK50

ø D ₁	d ₃	d ₄	l ₁	l ₂	l ₄	l _A	l _E	v	SK	Dimens.-Ident
20	41,6	50	184	63	48	82	40	10	SK 50	.200820
25	49,6	63	219	98	51	117	51	10	SK 50	.251170
32	59,9	63	219	98	59	117	51	10	SK 50	.321170

Umstellschraube Innenkühlung
Internal coolant screw plug



Anzugsbolzen für Steilkegel
Pull studs for ISO tapers

» 566

Werkzeug-Ident · Tool ident

TWA04001

Für For	Größe Dimension	Dimens.-Ident
SK 40	M5 x 5 x SW 2,5	.20005
SK 50	M8 x 6 x SW 4	.25006

Reduzierhülsen ø 20 mm
Reduction sleeves dia. 20 mm

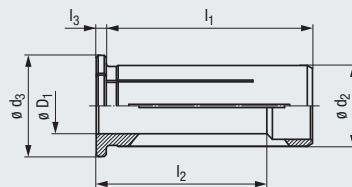

Werkzeug-Ident · Tool ident

TCHDRD20

ø D ₁	l ₁	l ₂	l ₃	d ₂	d ₃	Dimens.-Ident
3	50	28	4	20	25	.030500
6	50	36	4	20	25	.060500
8	50	37	4	20	25	.080500
10	50	40	4	20	25	.100500
12	50	45	4	20	25	.120500
14	50	45	4	20	25	.140500
16	50	48	4	20	25	.160500
18	50	48	4	20	25	.180500

● = Lagerwerkzeug, siehe Preisliste · Stock tool, see price list
○ = Kurzfristig lieferbar, Preis auf Anfrage · Available on short notice, price upon inquiry

- Product Finder
- v_c / f
- STEEL
- VA
- GG
- HCUT
- Zubehör Accessories
- Tech. Info

Für Steilkegel nach DIN 69871
For ISO tapers acc. DIN 69871

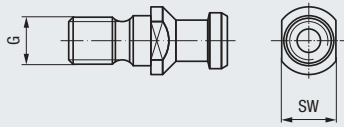

Werkzeug-Ident · Tool ident				TWA03001	TWA03002	TWA03003
Für Steilkegelgröße For ISO taper size	G	SW	Dimens.- Ident	DIN 69872 A	DIN 69872 B	ISO 7388 B
SK 40	M16	19	.04000	•	•	•
SK 50	M24	30	.05000	•	•	•

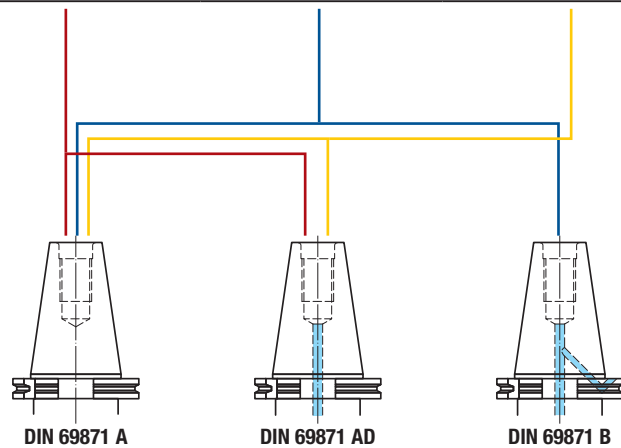

- 3 x D
- 5 x D
- 6 x D
- 8 x D
- 2-3,5 x D



Technische Informationen

Technical Information

Seite · Page

5.1	Nachschleif- und Wiederbeschichtungs-Service Regrinding and recoating service	568
5.2	Typische Spanformen Typical chip forms	569
5.3	Werkzeugspannung Tool clamping	570
5.4	Unterschied der Werkzeugspannung bei seitlicher Mitnahmeffläche und geneigter Spannfläche Differences in tool clamping with lateral driving flat and inclined clamping flat	570
5.5	Werkstückspannung Workpiece clamping	571
5.6	Kühlschmierstoff-Zufuhr Coolant supply	572
5.7	Spitzenwinkel Point angle	573
5.8	Einfluss des Spitzenwinkels Influence of the point angle	573
5.9	Technische Hinweise EF-Drill Micro Technical information EF-Drill Micro	574
5.10	Technische Hinweise EF-Drill Modular Technical information EF-Drill Modular	575 - 576
5.11	Probleme, mögliche Ursachen und Abhilfen beim Bohren Problems, possible causes and solutions in drilling	577 - 578
5.12	Technischer Fragebogen: Vollhartmetall-Spiralbohrer EF-Drill Technical questionnaire: Solid carbide twist drills EF-Drill	579 - 580

Product
Finderv_c / f

STEEL

VA

GG

HCUT

Zubehör
Accessories

Tech. Info

3 x D

5 x D

6 x D

8 x D

2-3,5 x D



Die Technischen Informationen der jeweiligen Kapitel dieses Kataloges sind in vielen Landessprachen auch als separate Druckerzeugnisse verfügbar. Bitte wenden Sie sich an den für Sie zuständigen Vertriebspartner.

The technical information complementing the various chapters of this catalogue is available also as a separate printed booklet in many different languages. Please speak to your usual sales contact.

- Product Finder
- v_c / f
- STEEL
- VA
- GG
- HCUT
- Zubehör
Accessories
- Tech. Info

5.1 Nachschleif- und Wiederbeschichtungs-Service

Das Nachschleifen und Wiederbeschichten ist ein wichtiger Bestandteil für den wirtschaftlichen Einsatz von Bohrwerkzeugen.

Der Nachschleif- und Wiederbeschichtungs-Service von EMUGE stellt die Wiederherstellung der Originalgeometrie und Originalbeschichtung eines Werkzeuges sicher.

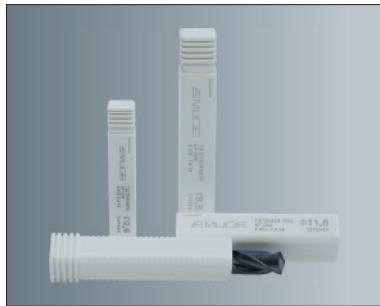
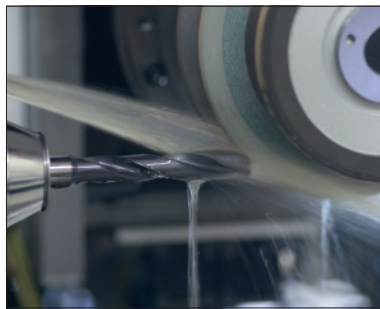

- 3 x D
- 5 x D
- 6 x D
- 8 x D
- 2-3,5 x D



5.1 Regrinding and recoating service

Regrinding and recoating form an essential contribution to the economically efficient use of drilling tools.

The EMUGE regrinding and recoating service guarantees the restoration of the original geometry and the original coating of the tool.

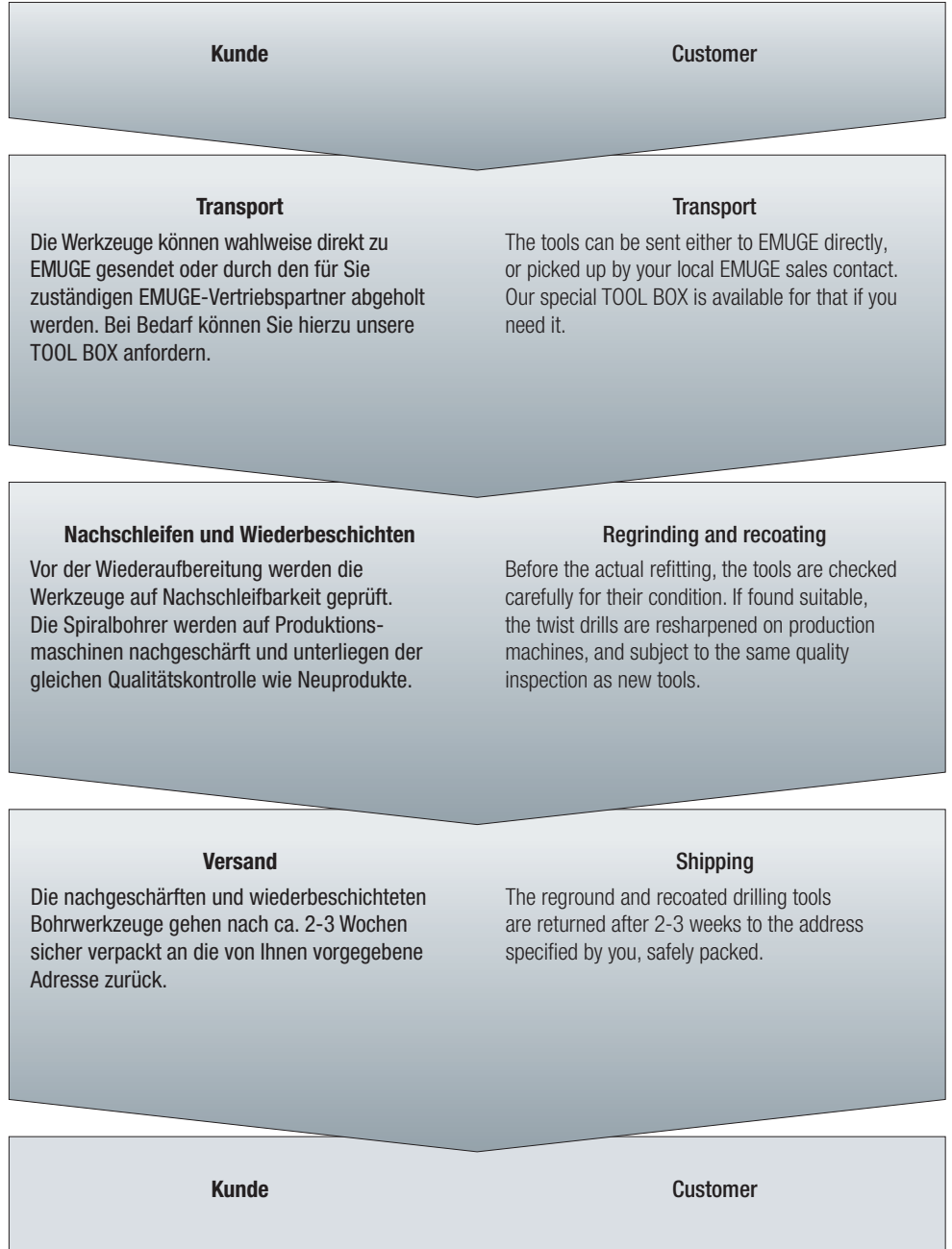

5.2 Typische Spanformen

5.2 Typical chip forms

	<p>Anbohrspan</p> <p>Dieser Span wird beim Anbohren erzeugt, bis die Schneidecken im Eingriff sind.</p>	<p>Start-of-drilling chip</p> <p>This chip type is produced in the start of the drilling process, before the cutting corners are engaged.</p>
	<p>Optimaler Bohrspan</p> <p>Dieser Span entsteht, wenn die Schnittdaten optimal gewählt sind.</p>	<p>Optimal drilling chip</p> <p>This chip type is created when the cutting data are chosen to perfection.</p>
	<p>Durchbohrspan</p> <p>Achtung: Erhöhter Platzbedarf zwischen Werkstück und Werkzeugaufnahme wird benötigt.</p>	<p>Drill-through chip</p> <p>Note: There is need for increased space between workpiece and tool holder.</p>
	<p>Durchbohrdeckel</p> <p>Achtung: Erhöhter Platzbedarf für Späne und Deckel beim Durchbohren!</p>	<p>Drill-through slug</p> <p>Note: There is need for increased space for chips and lid in drilling through!</p>
	<p>Fassspan</p> <p>Der Fassspan entsteht bei der Erzeugung der Fase.</p>	<p>Chamfer chip</p> <p>This chip type is created in the production of the chamfer.</p>
	<p>Stufenbohrspan</p> <p>Die Spanlänge dieses Spans kann bei langspanenden Werkstoffen über Verweilzeiten beeinflusst werden.</p>	<p>Step-drill chip</p> <p>The length of this chip type can be controlled by means of dwell times in long-chipping material.</p>
	<p>Verkettete Späne</p> <p>Diese entstehen besonders bei langspanenden Werkstoffen, bzw. nicht optimalen Schnittwerten. Einzelne Verkettungsspäne sind weniger problematisch. Bei Dauerverkettungsspänen führt dies mittelfristig zu Spanstau und somit zu Bohrerbruch.</p>	<p>Hooked up chips</p> <p>These chips are produced especially in long-chipping materials, or when cutting data are not optimally chosen. Single entangled chips are not such a big issue, but when the entanglement of the chips becomes permanent it will soon lead to chip clogging, and with it to drill breakage.</p>
	<p>Bandspan/Fließspan</p> <p>Achtung: Bei Entstehung dieser Späne zeigt der Bohrer bereits starke Beschädigungen an Haupt- und Querschneide! Dies bedeutet Standzeitende.</p>	<p>Ribbon chip / flow chip</p> <p>Note: When you observe this chip type, the drill already has serious damage on primary cutting edge and chisel edge! This means an end to tool life.</p>

Product
Finderv_c / f

STEEL

VA

GG

HCUT

Zubehör
Accessories

Tech. Info

3 x D

5 x D

6 x D

8 x D

2-3,5 x D



- Product Finder
- v_c / f
- STEEL
- VA
- GG
- HCUT
- Zubehör
Accessories
- Tech. Info

5.3 Werkzeugspannung

5.3 Tool clamping

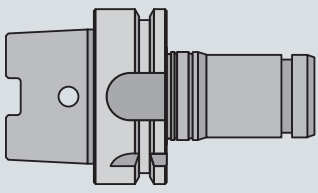
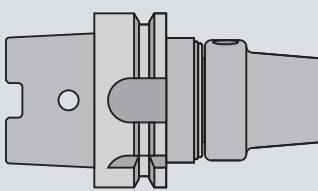
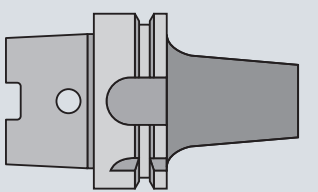
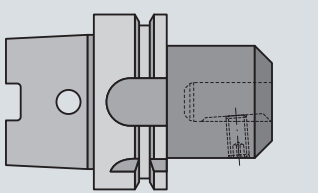
	<p>Spannzangen-Aufnahme Typ PGR Rundlaufgenauigkeit < 3 µm</p> <ul style="list-style-type: none"> • Schmale Bauweise • Reduziert Vibrationen 	<p>Collet holders type PGR Concentricity < 3 µm</p> <ul style="list-style-type: none"> • Slender construction • Reduced vibrations
	<p>Hydrodehnspannfutter Rundlaufgenauigkeit < 3 µm</p> <ul style="list-style-type: none"> • Reduziert Vibrationen 	<p>Hydraulic expansion chucks Concentricity < 3 µm</p> <ul style="list-style-type: none"> • Reduced vibrations
	<p>Schrumpf-Aufnahme Rundlaufgenauigkeit < 3 µm</p> <ul style="list-style-type: none"> • Schmale Bauweise 	<p>Shrink-fit chucks Concentricity < 3 µm</p> <ul style="list-style-type: none"> • Slender construction
	<p>Werkzeug-Aufnahme für Zylinderschäfte mit geneigter Spannfläche Rundlaufgenauigkeit < 15 µm</p> <ul style="list-style-type: none"> • Kostengünstig 	<p>Tool holders for straight shanks with inclined clamping flat Concentricity < 15 µm</p> <ul style="list-style-type: none"> • Economically efficient

- 3 x D
- 5 x D
- 6 x D
- 8 x D
- 2-3,5 x D

5.4 Unterschied der Werkzeugspannung bei seitlicher Mitnahmefläche und geneigter Spannfläche

5.4 Differences in tool clamping with lateral driving flat and inclined clamping flat

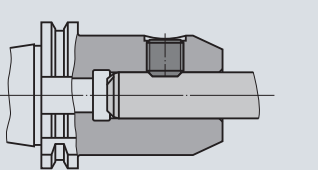
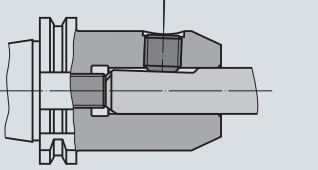
	<p>Seitliche Mitnahmefläche Aufnahme von Werkzeugen mit seitlicher Mitnahmefläche nach DIN 6535 HB bzw. DIN 1835 B. Diese Aufnahme hat keine axiale Abstützung und ist daher für Bohroperationen nicht geeignet.</p>	<p>Lateral driving flat Clamping of tools with lateral driving flat acc. DIN 6535 HB resp. DIN 1835 B. This type of clamping has no axial support and is therefore not suitable for drilling operations.</p>
	<p>Geneigte Spannfläche Aufnahme von Werkzeugen mit geneigter Spannfläche nach DIN 6535 HE bzw. DIN 1835 E.</p>	<p>Inclined clamping flat Clamping of tools with inclined clamping flat acc. DIN 6535 HE resp. DIN 1835 E.</p>

5.5 Werkstückspannung

Voraussetzungen für den Einsatz von Spiralbohrern:

- Das Werkstück muss fest aufliegen, darf nicht federn oder durchbiegen
- Abhilfe schaffen zusätzliche Auflagepunkte
- Bei dünnen Wandstärken muss der Vorschub reduziert werden

Vollhartmetall-Spiralbohrer reagieren empfindlich auf Biegebeanspruchung!

5.5 Workpiece clamping

Basic conditions for the use of twist drills:

- The workpiece must be firmly supported, without a chance to bounce or bend
- Additional support points will help
- With thin-walled workpieces, feed must be reduced

Solid carbide twist drills are extremely sensitive to bending stress!

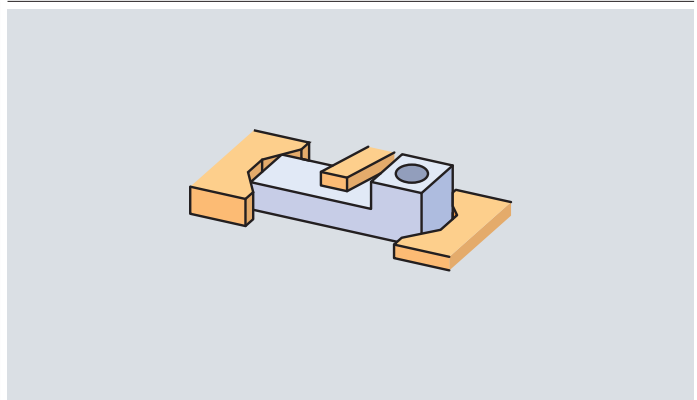
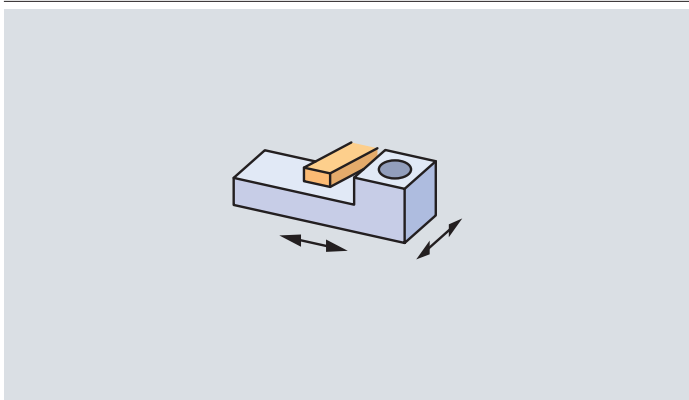
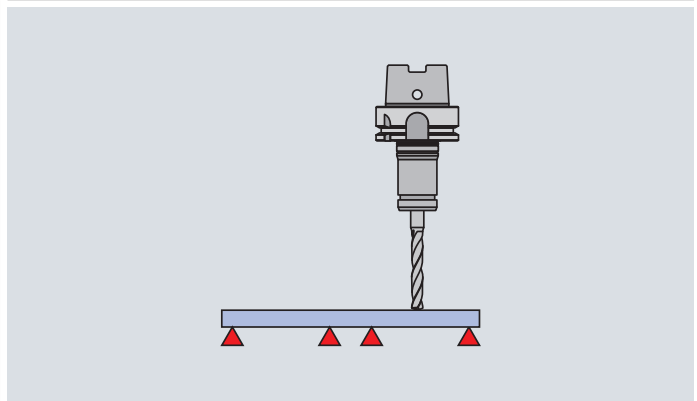
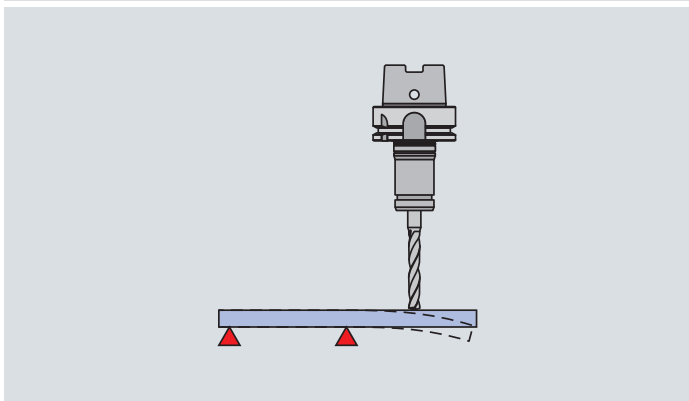
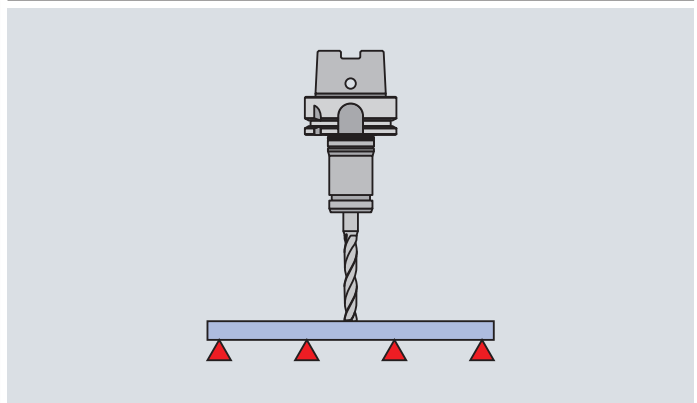
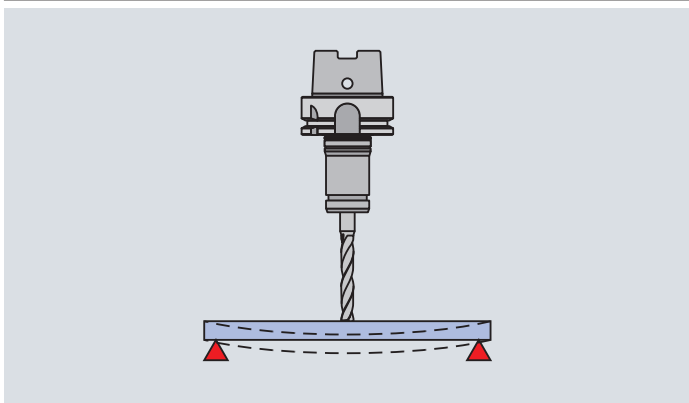
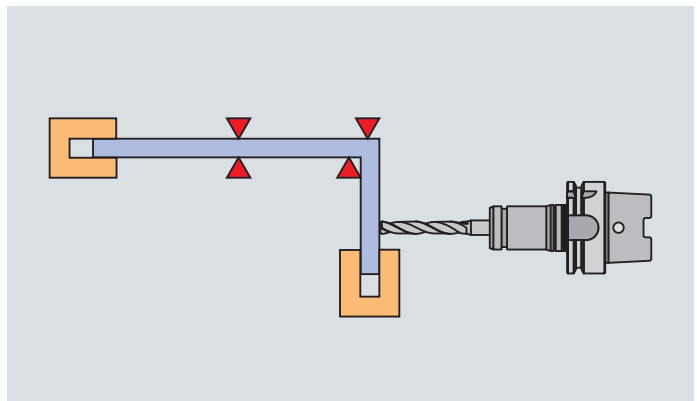
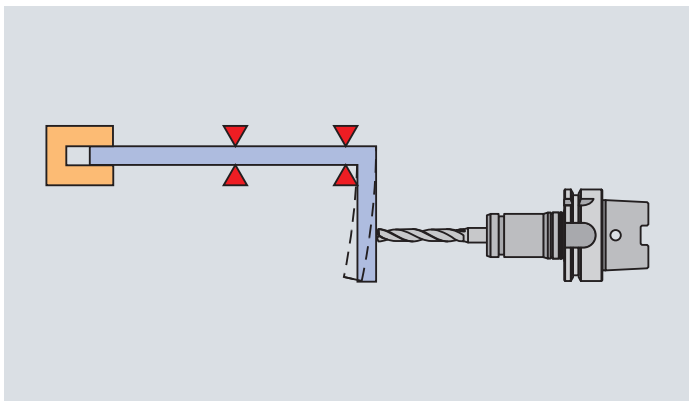
Falsche Werkstückspannung
Wrong workpiece clampingRichtige Werkstückspannung
Correct workpiece clampingProduct
Finderv_c / f

STEEL

VA

GG

HCU

Zubehör
Accessories

Tech. Info

3 x D

5 x D

6 x D

8 x D

2-3,5 x D



- Product Finder
- v_c / f
- STEEL
- VA
- GG
- HCUT
- Zubehör
Accessories
- Tech. Info

5.6 Kühlschmierstoff-Zufuhr

Innenkühlung ist bei Bohrtiefen über $2 \times D$ immer zu bevorzugen. Ab einer Bohrtiefe von $5 \times D$ ist sie unbedingt erforderlich. Bei der Außenkühlung ist neben dem ausreichenden Kühlschmierstoff-Druck auch auf die richtige Zuführung zu achten.

Wann immer möglich, sollten drei Kühlschmierstoff-Strahlen auf den Spiralbohrer treffen.

5.6 Coolant supply

Internal cooling is always to be recommended when drill depth exceeds $2 \times D$. From a drill depth of $5 \times D$, it is absolutely necessary. With external cooling, make sure to provide not only sufficient coolant pressure but also the right type of supply.

Wherever possible, three coolant-lubricant jets should hit the twist drill directly.

		Schlechte Kühlschmierstoff-Zufuhr Bad coolant supply	Gute Kühlschmierstoff-Zufuhr Good coolant supply
Vertikale Bearbeitung Vertical machining	$3 \times D$ $5 \times D$		<div style="display: flex; justify-content: space-around;"> <div> <p>Gut Good</p> </div> <div> <p>Besser Better</p> </div> </div>
	$6 \times D$ $8 \times D$ $2-3,5 \times D$		
Horizontale Bearbeitung Horizontal machining			



5.7 Spitzenwinkel

Anzentrierung und Pilotbohrung

Bei langen, spannmittelbedingten Auskragungen muss anzentriert oder besser eine Pilotbohrung gesetzt werden.

Bei Werkzeuglängen über $8 \times D$ ist mit reduziertem Vorschub anzubohren oder eine Anzentrierung bzw. Pilotbohrung zu empfehlen.

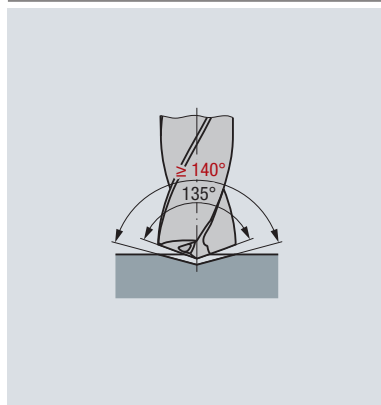

Anzentrierung

Zu beachten gilt, dass der Spitzenwinkel des Vorbohrers größer als der des Folgebohrers ist. Zu empfehlen sind hier EF-Drill nach DIN 6537 K. Die Anzentrierung sollte nicht tiefer sein als die Spitzenlänge l_5 .

Centering

Please note that the point angle of the first, or preparatory drill must be larger than that of the subsequent drill. We recommend our twist drills EF-Drill acc. DIN 6537 K. The centering should not be deeper than the point length l_5 .

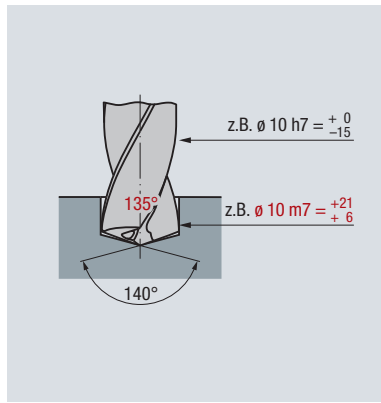

Pilotbohrung

Eine Pilotbohrung kommt beim Tieflochbohren zur Anwendung. Zu beachten ist, dass Spitzenwinkel und Durchmesser des Pilotbohrers größer als beim Folgebohrer sind. Eine Tiefe der Pilotbohrung von $1 \times D$ ist ausreichend.

Pilot hole

A pilot hole is used for deep-hole drilling. Please note that the point angle and the diameter of the pilot drill must be larger than those of the subsequent drill. For the pilot hole, a depth of $1 \times D$ is sufficient.

5.8 Einfluss des Spitzenwinkels

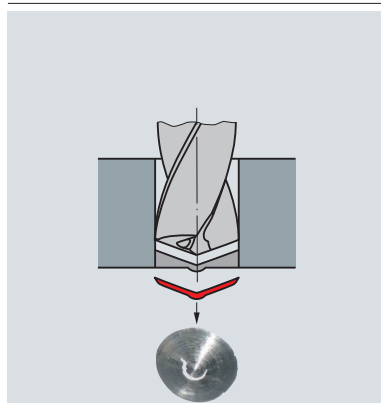

Standard-Spitzenwinkel 140° (EF-Drill)

- Stabile Spitze
- Kurzer Span
- Gute Zentrierung
- Geringerer Leistungsbedarf
- Geringeres Drehmoment
- Deckelbildung
- Gratbildung gering
- Hoher Standweg

Standard point angle 140° (EF-Drill)

- Stable point
- Short chips
- Good centering
- Reduced power consumption
- Reduced torque
- Formation of slug
- Minimal burr formation
- Long tool life

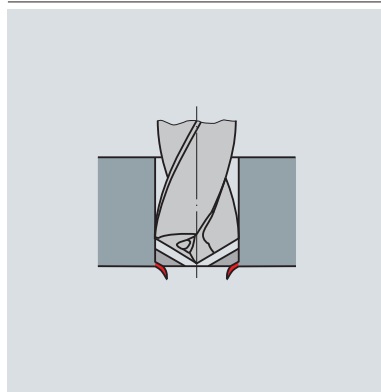

Spitzenwinkel 118°

- Labile Spitze
- Hohes Drehmoment
- Hohe Leistungsaufnahme
- Instabile Hauptschneiden
- Geringe Deckelbildung
- Gratbildung beim Austritt

Point angle 118°

- Unstable point
- High torque
- High power consumption
- Unstable primary cutting edges
- Slug formation very much reduced
- Formation of burr during the exit of the drill

Product Finder

 v_c / f

STEEL

VA

GG

HCUT

Zubehör
Accessories

Tech. Info

3 x D

5 x D

6 x D

8 x D

2-3,5 x D

- Product Finder
- v_c / f
- STEEL
- VA
- GG
- HCUT
- Zubehör
Accessories
- Tech. Info**

5.9 Technische Hinweise EF-Drill Micro

5.9 Technical information EF-Drill Micro

- 3 x D
- 5 x D
- 6 x D
- 8 x D
- 2-3,5 x D

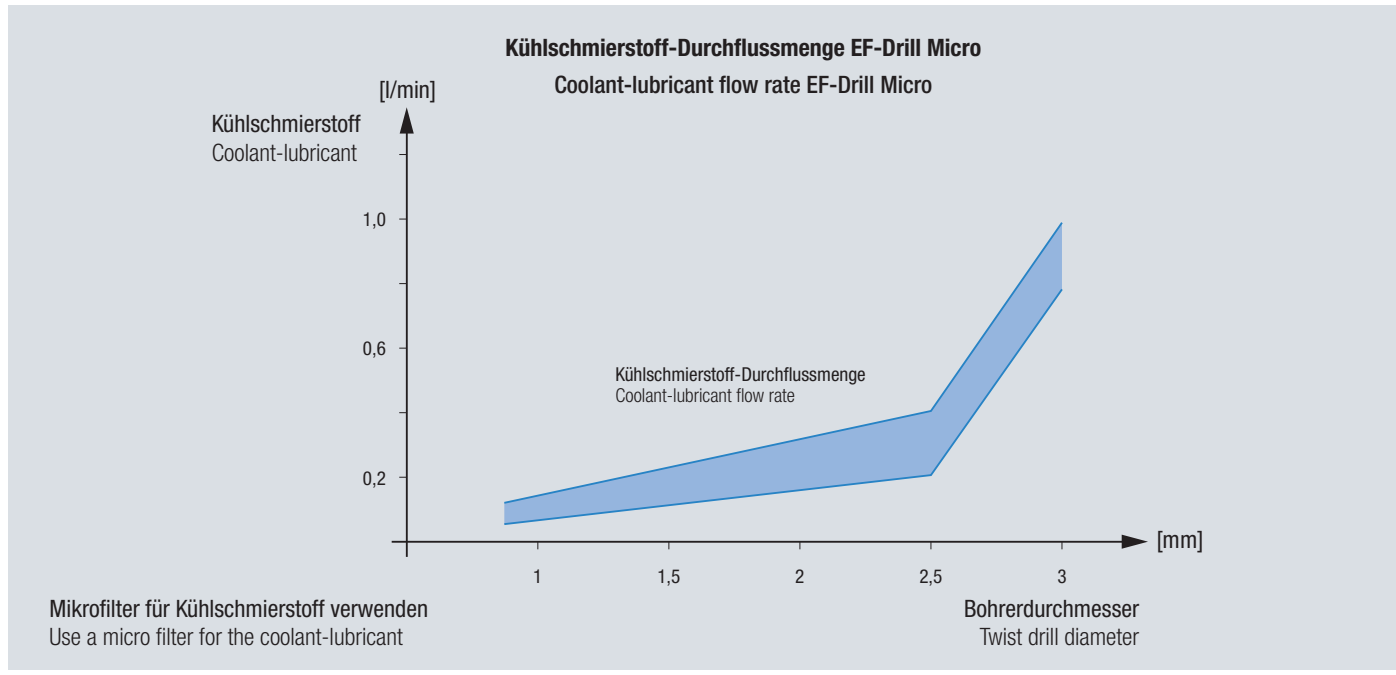
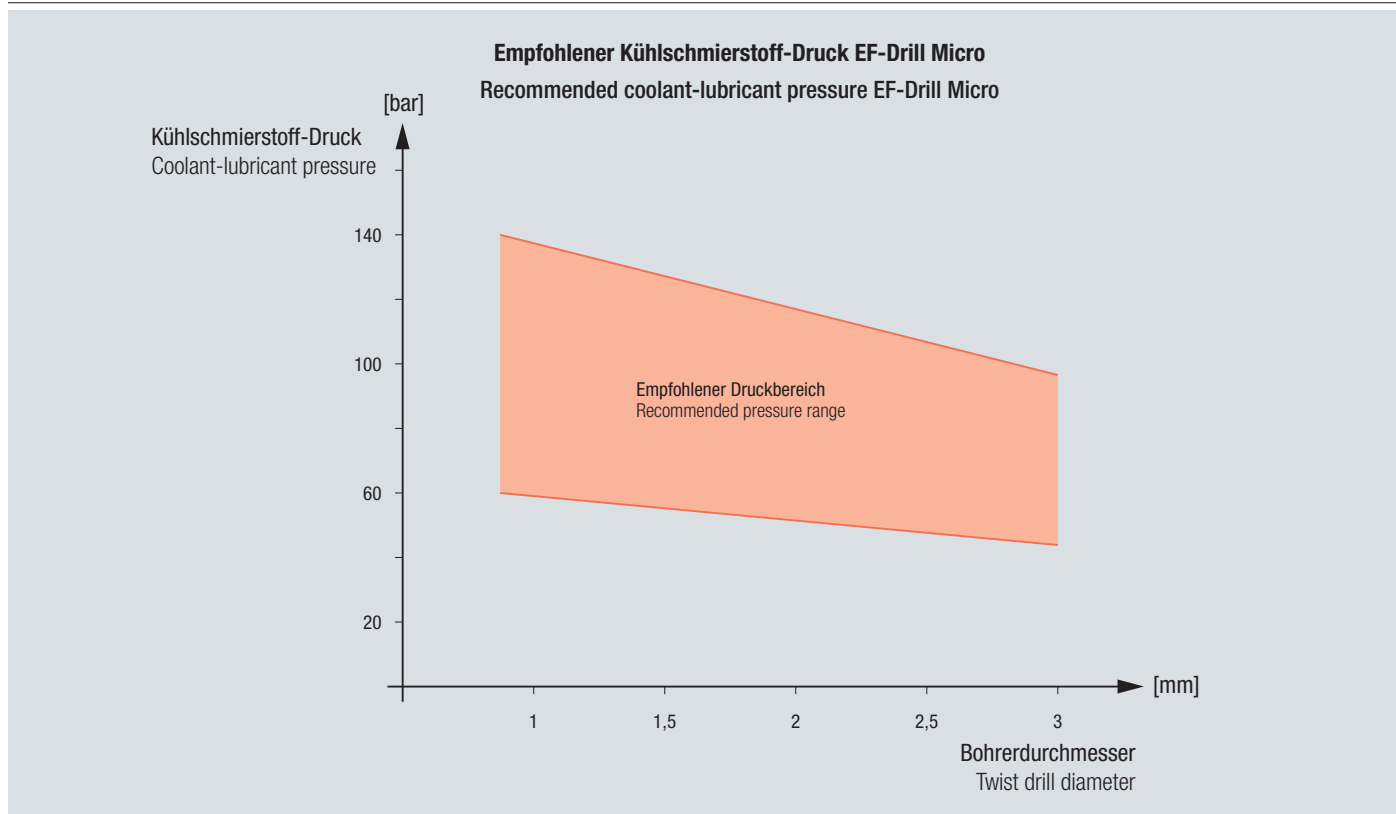

Mikrofilter für Kühlschmierstoff verwenden
Use a micro filter for the coolant-lubricant



5.10 Technische Hinweise EF-Drill Modular

5.10 Technical information EF-Drill Modular

Montage des Bohrkopfes in den Halter

Assembly of drill head into holder

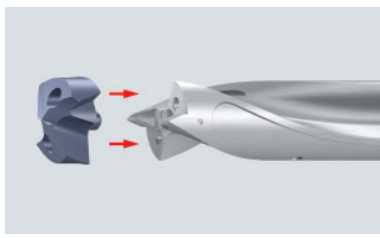

Schneidkopf in den gereinigten Halter einsetzen.

Insert the cutting head into the cleaned holder.

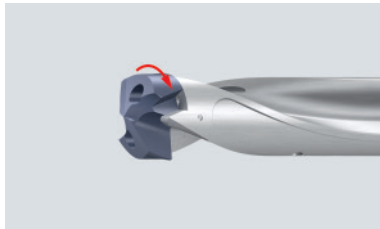

Schneidkopf im Uhrzeigersinn bis zum Anschlag drehen.

Turn the cutting head clockwise up to the stop.

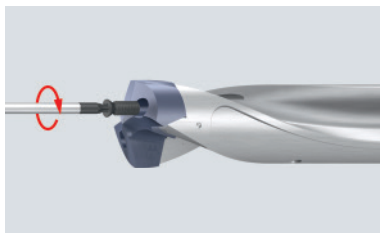

Eine Schraube in die Befestigungsbohrung einsetzen und leicht anziehen.

Insert a screw into the mounting bore and tighten it gently.

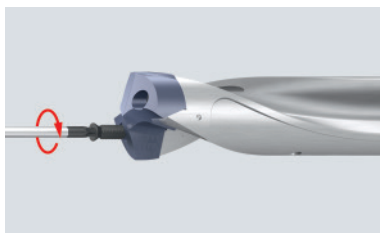

Zweite Schraube in die Befestigungsbohrung einsetzen und fest anziehen.

Insert the second screw into the mounting bore and tighten it firmly.

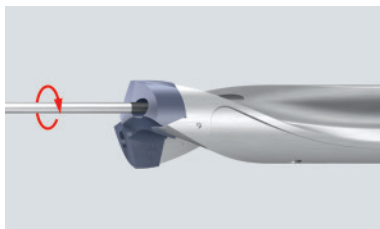

Erste Schraube mit empfohlenem Drehmoment anziehen. Zweite Schraube noch einmal mit empfohlenem Drehmoment nachziehen.

Tighten the first screw with the recommended torque. Retighten the second screw with the recommended torque.

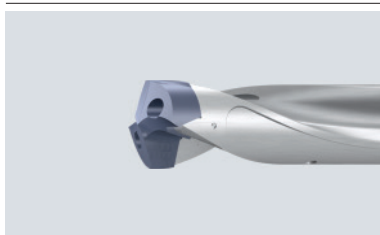

Fertig montiertes Werkzeug.

Tool completely assembled.

Anzugsdrehmomente für Spannschrauben

Tightening torques for clamping screws

Plattensitzgröße Size of insert seat	Größe Size	Empf. Anzugsdrehmoment Rec. tightening torque (Nm)
2	Torx T7	0,60
3	Torx T8	0,88
4	Torx T8	1,53
5	Torx T9	2,44
6	Torx T15	3,66
7	Torx T15	5,22

Product
Finderv_c / f

STEEL

VA

GG

HCUT

Zubehör
Accessories

Tech. Info

3 x D

5 x D

6 x D

8 x D

2-3,5 x D



- Product Finder
- v_c / f
- STEEL
- VA
- GG
- HCUT
- Zubehör Accessories
- Tech. Info**

5.10 Technische Hinweise EF-Drill Modular

5.10 Technical information EF-Drill Modular

Bearbeitungssituation

Machining condition

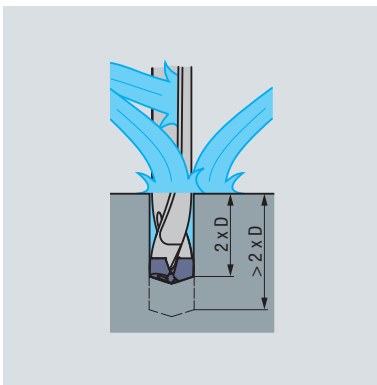

Außenkühlung bis 2 x D möglich,
ab 2 x D in Steps bohren.

Innenkühlung ist immer zu bevorzugen.
Empfohlener Kühlschmierstoff-Druck: > 20 bar.

External cooling possible up to 2 x D.
From 2 x D drill in steps.

Internal cooling should always be preferred.
Recommended coolant-lubricant pressure: > 20 bar.

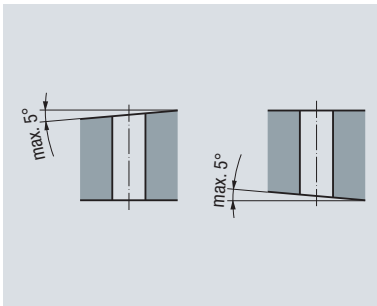

Schräger Ein- und Austritt $\leq 5^\circ$.

Slanting entering and exit $\leq 5^\circ$.

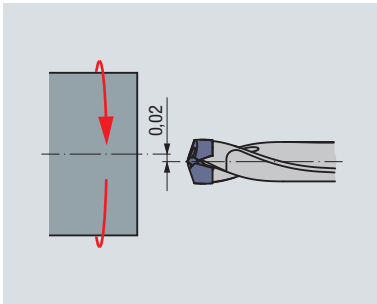

Maximaler Achsversatz 0,02 mm.

Maximum axle offset 0.02 mm.

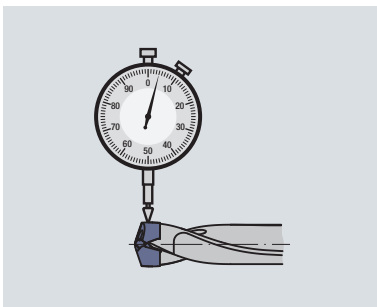

Maximaler Rundlauffehler < 0,04 mm.

Maximum run-out < 0.04 mm.



5.11 Probleme, mögliche Ursachen und Abhilfen
beim Bohren5.11 Problems, possible causes and solutions
in drillingProduct
Finderv_c / f

STEEL

VA

GG

HCUT

Zubehör
Accessories

Tech. Info

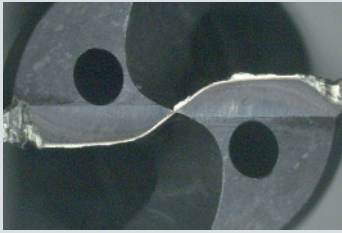
**Probleme:**

- Übermäßiger Eckenverschleiß
- Aufbauschnide
- Führungsfasenverschleiß

Mögliche Ursachen:

- Zu lange Bearbeitungszeiten
- Hohe Temperatur und/oder Reibung
- Rundlauffehler > 0,02 mm
- Instabile Spannung des Werkstückes oder Werkzeuges
- Fettgehalt des Kühlschmierstoffes zu niedrig

Abhilfen:

- Spiralbohrer rechtzeitig wechseln und nachschleifen
- Kühlschmierstoff-Volumen erhöhen
- Kühlschmierstoff mit höherem Ölgehalt bzw. Additive verwenden
- Schnittgeschwindigkeit reduzieren
- Reduzierung des Vorschubes beim Durchbrechen

Problems:

- Excessive wear on the corners
- Built-up edge
- Wear on the margins

Possible causes:

- Excessive machining times
- High temperature and/or friction
- Concentricity run-out > 0.02 mm
- Unstable clamping of workpiece or tool
- Coolant-lubricant too dry

Solutions:

- Exchange twist drill in time and regrind
- Increase coolant-lubricant volume
- Use coolant-lubricant with higher oil content, or additives
- Reduce cutting speed
- Reduce feed for drilling through

**Problem:**

- Abplatzungen an den Schneidecken

Mögliche Ursachen:

- Zu hoher Vorschub
- Werkstück bewegt sich beim Durchbrechen
- Maschine ist instabil
- Spiralbohrer rutscht auf Grund unzureichender Werkzeugspannung
- Rundlauffehler > 0,02 mm

Abhilfen:

- Verbesserung der Werkstückspannung
- Anderes Spannmittel verwenden, z.B. Spannsystem Typ PGR oder Hydrodehnspannfutter
- Vorschub reduzieren

Problem:

- Chipping on the cutting corners

Possible causes:

- Excessive feed
- Workpiece moves when the drill breaks through
- Machine is unstable
- Twist drill slips due to unsatisfactory tool clamping
- Concentricity run-out > 0.02 mm

Solutions:

- Improve workpiece clamping
- Use a different clamping tool, e.g. clamping system PGR or hydraulic expansion chuck
- Reduce feed

3 x D

5 x D

6 x D

8 x D

2-3,5 x D

**Problem:**

- Ablösen der Schicht an der Führungsfase

Mögliche Ursachen:

- Zu hohe Reibung
- Schräger Austritt
- Adhäsiver Werkstoff
- Zu viele Nachschliffe (Schichtdicke zu hoch)

Abhilfen:

- Kühlschmierstoff mit höherem Ölgehalt bzw. Additive verwenden
- Vorschub beim Austritt reduzieren
- Anzahl der Nachschliffe reduzieren

Problem:

- Coating coming off on the margins

Possible causes:

- Excessive friction
- Slanted exit
- Adhesive workpiece material
- Reground too many times (excessive coating thickness)

Solutions:

- Use coolant-lubricant with higher oil content, or additives
- Reduce feed for exiting
- Reduce the number of times you regrind your drills



- Product Finder
- v_c / f
- STEEL
- VA
- GG
- HCUT
- Zubehör
Accessories
- Tech. Info

5.11 Probleme, mögliche Ursachen und Abhilfen beim Bohren

5.11 Problems, possible causes and solutions in drilling

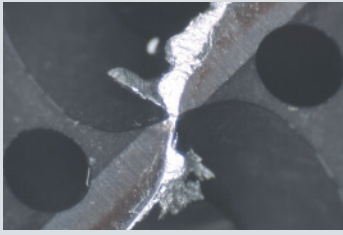

Problem:

- Aufbauschneide an der Hauptschneide

Mögliche Ursachen:

- Falsche Schnittwerte
- Zu hoher Freiflächenverschleiß
- Schädigung an den Schneiden
- Schlechte Kühlschmierung

Abhilfen:

- Kühlschmierstoff mit höherem Ölgehalt bzw. Additive verwenden
- Schnittgeschwindigkeit erhöhen
- Vorschub reduzieren
- Werkzeugwechsel

Problem:

- Built-up edge on the primary cutting edge

Possible causes:

- Wrong cutting data
- Excessive wear on relief surfaces
- Damage on the cutting edges
- Bad coolant supply

Solutions:

- Use coolant-lubricant with higher oil content, or additives
- Increase cutting speed
- Reduce feed
- Exchange tools

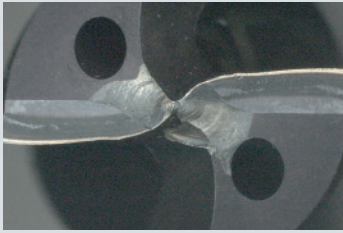

Problem:

- Abplatzungen an der Querschneide

Mögliche Ursachen:

- Vibrationen
- Rundlauffehler > 0,02 mm
- Raue oder geneigte Werkstückoberfläche

Abhilfen:

- Vorschub reduzieren
- Anderes Spannmittel verwenden
- Werkstückoberfläche verbessern (z.B. Anspiegeln)

Problem:

- Splintering on the chisel edge

Possible causes:

- Vibrations
- Concentricity run-out > 0.02 mm
- Rough or slanted workpiece surface

Solutions:

- Reduce feed
- Use a different clamping tool
- Improve workpiece surface (e.g. by spot-facing)



5.12 Technischer Fragebogen: Vollhartmetall-Spiralbohrer EF-Drill

Firma:
 Ansprechpartner:
 Telefon:
 Fax:
 E-Mail:

Bohrungsdurchmesser:
 Bohrungstoleranz:
 Bohrer Ausführung:
 Artikel-Nr.:
 Projekt:

Werkstückbezeichnung:

Lochform (bitte Maße eintragen):

⇒ = Bearbeitungsrichtung

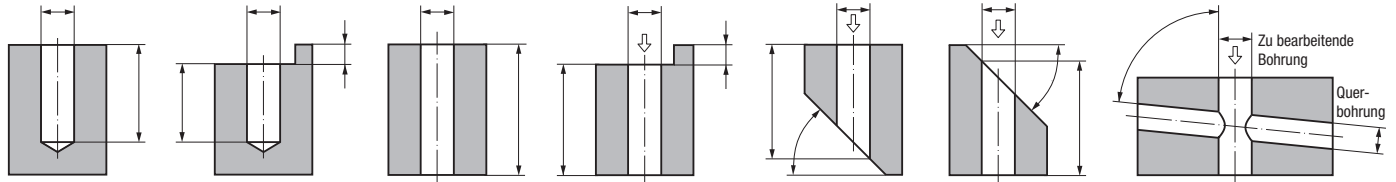

Vorbearbeitung:

Oberfläche: gedreht/gefräst roh gegossen Sonstiges:

Vorbohrung:

ohne
 gebohrt
 gegossen
 Sonstiges:

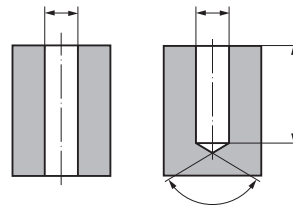

Maschine:

Hersteller:
 Typ:
 Antriebsleistung: kW
 horizontal Werkzeug rotierend
 vertikal Werkzeug stehend

Werkstückwerkstoff:

Bezeichnung:
 Behandlungszustand:
 Festigkeit: N/mm²
 Härte: Dehnung: %
 kurzspanend langspanend

Schnittdaten:

Drehzahl n: min⁻¹
 Schnittgeschwindigkeit v_c: m/min
 Vorschub f: mm/U
 Vorschubgeschwindigkeit v_f: mm/min

Werkzeug-Empfehlung:

Ausführung:
 Artikel-Nr.:
 Schaftdurchmesser: mm
 Schaftausführung: DIN 6535 HA HE
 Besonderheit:

Schaftform:

Schaftdurchmesser: mm
 Schaftausführung: DIN 6535 HA HE

Kühlung:

Innere Kühlschmierstoff-Zufuhr: nein ja Druck: bar
 Medium: Öl Emulsion: %
 MMS Trocken / Druckluft

Bisher verwendete Werkzeuge (Hersteller):

Stückzahl:

Standwert: (Anzahl Bohrungen)

Standweg: m

Aufgenommen von:

Datum / Unterschrift:



- Product Finder
- v_c / f
- STEEL
- VA
- GG
- HCUT
- Zubehör Accessories
- Tech. Info

5.12 Technical questionnaire: Solid carbide twist drills EF-Drill

Company: Drilled hole diameter:

Contact: Drilled hole tolerance:

Phone: Drill design:

Fax: Article no.:

E-Mail: Project:

Workpiece description:

Hole type (please enter dimensional specifications):

⇒ = Machining direction

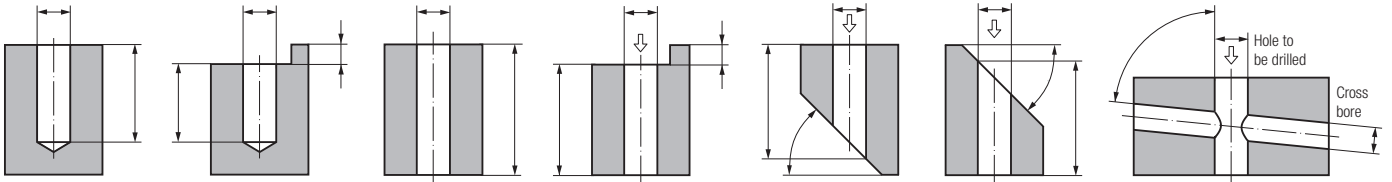

Preparatory work:

Surface: turned/milled rough cast others:

Pilot hole:

without

drilled

cast

others:

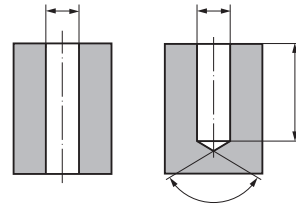

Maschine:

Manufacturer:

Type:

Power: kW

horizontal rotating tool

vertical standing tool

Workpiece material:

Description:

Condition during work:

Tensile strength: N/mm²

Hardness: Elongation: %

short-chipping long-chipping

Cutting data:

Speed n: rpm

Cutting speed v_c : m/min

Feed f: mm/rev.

Feed speed v_f : mm/min

Tool recommendation:

Design:

Article no.:

Shank diameter: mm

Shank design: DIN 6535 HA HE

Special features:

Shank type:

Shank diameter: mm

Shank design: DIN 6535 HA HE

Cooling:

Internal coolant supply: no yes Pressure: bar

Medium: Oil Emulsion: %

MQL Dry/pressurised air

Tools used until now (manufacturer):

Tool life: (no. of drilled holes)

Tool path: m

Quantity:

Filled in by:

Date / Signature:



Gewindelehren Thread Gauges

Seite · Page

Übersicht

Contents

582 - 583

Produktseiten

Product pages

584 - 634

Technische Informationen

Technical Information

635 - 654



Product Finder

- M
- MF
- UNC
- UNF
- G
- Rp, R, Rc
- NPT, NPTF
- BSW
- Pg
- MJ
- UNJC, UNJF

- EG (STI) SELF-LOCK
- Tr, Tr-F Rd
- Glatt Smooth
- GT, TD
- Zubehör Accessories
- Kalibrieren Calibration
- Tech. Info



Seite · Page

M	584 -585	585	585
MF	588 - 589	590 - 597	591 - 597
UNC	606	606	606
UNF	608	608	608
G (BSP)	610	610	610
Rp, R, Rc			
NPT			
NPTF			
BSW	614	614	614
Pg	615	615	615
MJ	616		
UNJC	616		
UNJF	616		
EG M (STI)	617		
LK-M	618		
Tr	619	619	619
Tr-F	620	620	620
Rd	621	621	621

Seite · Page

Glatte Grenz-, Gut- und Ausschuss-Lehrdorne
Smooth plug gauges go/no-go, go, and no-go

622

Glatte Kernloch-Grenzlehndorne für Metrische Gewinde
Smooth plug gauges go/no-go for thread holes, for Metric threads

623



DECOM-Prüflabor im Hause EMUGE
DECOM Calibration Laboratory at EMUGE

631 - 634

Gewinde-
Gutlehringe
Thread ring
gauges go

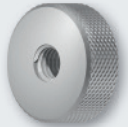

G-GUT-LR

Gewinde-
Ausschusslehringe
Thread ring
gauges no-go



G-AUS-LR

Gewindelehren
für kegelige Gewinde
Thread gauges
for tapered threads



G-GR-LD, G-GR-LR

Product
Finder

- M
- MF
- UNC
- UNF
- G
- Rp, R, Rc
- NPT, NPTF
- BSW
- Pg
- MJ
- UNJC, UNJF
- EG (STI) SELF-LOCK
- Tr, Tr-F Rd
- Glatt Smooth
- GT, TD
- Zubehör Accessories
- Kalibrieren Calibration
- Tech. Info

Seite · Page

586	587		M
598 - 604	599 - 605		MF
607	607		UNC
609	609		UNF
610	610		G (BSP)
		611	Rp, R, Rc
		612	NPT
		613	NPTF
614	614		BSW
615	615		Pg
			MJ
			UNJC
			UNJF
			EG M (STI)
			LK-M
619	619		Tr
620	620		Tr-F
621	621		Rd

Seite · Page



Gewinde-Tiefenlehrdorne
Thread depth plug gauges

624 - 627

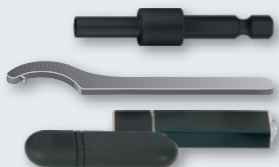

Sechskant-Bit-Adapter und Zubehör
Hexagon bit adapters and accessories

628 - 629



- Product Finder
- M
- MF
- UNC
- UNF
- G
- Rp
R, Rc
- NPT, NPTF
- BSW
- Pg
- MJ
UNJC, UNJF
- EG (STI)
SELF-LOCK
- Tr, Tr-F
Rd
- Glatt
Smooth
- GT, TD
- Zubehör
Accessories
- Kalibrieren
Calibration
- Tech. Info

M



DIN 13

Lehrenmaße nach DIN ISO 1502
Gauge dimensions acc. DIN ISO 1502

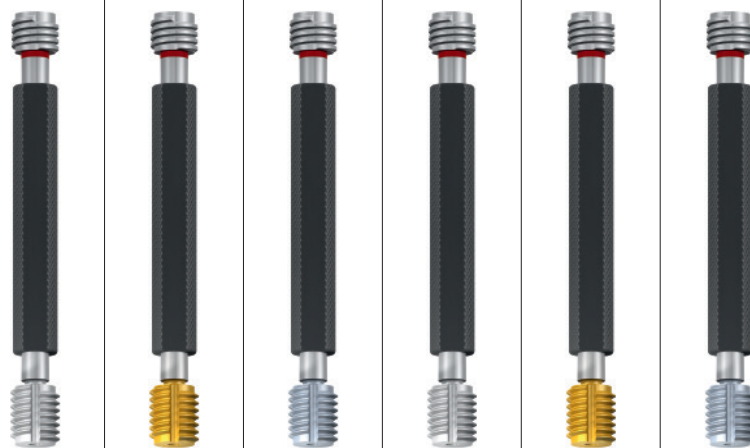

Toleranz · Tolerance
Beschichtung · Coating

6H	6H TIN	6H CR	4H	4H TIN	4H CR
----	-----------	----------	----	-----------	----------

Werkzeug-Ident · Tool ident

L0100100	L0105100	L0101100	L0100110	L0105110	L0101110
----------	----------	----------	----------	----------	----------

ø d ₁ mm	P mm	Dimens.- Ident	G-GR-LD						
			G-GR-LD	G-GR-LD TIN	G-GR-LD CR	G-GR-LD „4H“	G-GR-LD TIN „4H“	G-GR-LD CR „4H“	
M 1	0,25	.0010	●*)						
1,1	0,25	.0011	●*)						
1,2	0,25	.0012	●*)						
1,4	0,3	.0014	●*)						
1,6	0,35	.0016	●						
1,7	0,35	.0017	●						
1,8	0,35	.0018	●						
2	0,4	.0020	●				●		
2,2	0,45	.0022	●				●		
2,3	0,4	.0023	●						
2,5	0,45	.0025	●				●		
2,6	0,45	.0026	●						
3	0,5	.0030	●	●	●	●	●	○	○
3,5	0,6	.0035	●	●	●	●	●	○	○
4	0,7	.0040	●	●	●	●	●	○	○
4,5	0,75	.0045	●	●	●	●	●	○	○
5	0,8	.0050	●	●	●	●	●	○	○
6	1	.0060	●	●	●	●	●	○	○
7	1	.0070	●	●	●	●	●	○	○
8	1,25	.0080	●	●	●	●	●	○	○
9	1,25	.0090	●	●	●	●	●	○	○
10	1,5	.0100	●	●	●	●	●	○	○
11	1,5	.0111	●	●	●	●	●	○	○
12	1,75	.0112	●	●	●	●	●	○	○
14	2	.0114	●	●	●	●	●	○	○
16	2	.0116	●	●	●	●	●	○	○
18	2,5	.0118	●	●	●	●	●	○	○
20	2,5	.0120	●	●	●	●	●	○	○
22	2,5	.0122	●	●	●	●	●	○	○
24	3	.0124	●	●	●	●	●	○	○
27	3	.0127	●						
30	3,5	.0130	●						
33	3,5	.0133	●						
36	4	.0136	●						
39	4	.0139	●						
42	4,5	.0142							
45	4,5	.0145							
48	5	.0148							
52	5	.0152							
56	5,5	.0156							
60	5,5	.0160							
64	6	.0164							
68	6	.0168							

*) ≤ M1,4 Tol. 5H



Product Finder

M

MF

UNC

UNF

G

Rp

R, Rc

NPT, NPTF

BSW

Pg

MJ

UNJC, UNJF

EG (STI)

SELF-LOCK

Tr, Tr-F

Rd

Glatt

Smooth

GT, TD

Zubehör

Accessories

Kalibrierung

Calibration

Tech. Info

6G	6G TIN	6G CR	6E	6H LH	6H	6H TIN	6H CR	6H	
L0100120	L0105120	L0101120	L0100130	L0100150	L0120100	L0125100	L0121100	L0140100	
G-GR-LD	G-GR-LD	G-GR-LD	G-GR-LD	G-GR-LD	G-GUT-LD	G-GUT-LD	G-GUT-LD	G-AUS-LD	
„6G“	TIN „6G“	CR „6G“	„6E“	LH		TIN	CR		
					●*)			●*)	M 1
					●*)			●*)	1,1
					●*)			●*)	1,2
					●*)			●*)	1,4
					●			●	1,6
					●			●	1,7
					●			●	1,8
●				●	●			●	2
●				●	●			●	2,2
					●			●	2,3
●				●	●			●	2,5
●	○	○	●	●	●	●	●	●	2,6
●				●	●			●	3
●	○	○	●	●	●	●	●	●	3,5
●				●	●			●	4
●	○	○	●	●	●	●	●	●	4,5
●				●	●			●	5
●	○	○	●	●	●	●	●	●	6
●				●	●			●	7
●	○	○	●	●	●	●	●	●	8
●				●	●			●	9
●	○	○	●	●	●	●	●	●	10
●				●	●			●	11
●	○	○	●	●	●	●	●	●	12
●				●	●			●	14
●	○	○	●	●	●	●	●	●	16
●				●	●			●	18
●	○	○	●	●	●	●	●	●	20
●				●	●			●	22
●	○	○	●	●	●	●	●	●	24
					●			●	27
					●			●	30
					●			●	33
					●			●	36
					●			●	39
					●			●	42
					●			●	45
					●			●	48
					●			●	52
					●			●	56
					●			●	60
					●			●	64
					●			●	68

> ø 40 nur als Einzellehrdorne erhältlich (G-GUT-LD, G-AUS-LD)
available only as separate plug gauges (G-GUT-LD, G-AUS-LD)



- Product Finder
- M
- MF
- UNC
- UNF
- G
- Rp
R, Rc
- NPT, NPTF
- BSW
- Pg
- MJ
UNJC, UNJF
- EG (STI)
SELF-LOCK
- Tr, Tr-F
Rd
- Glatt
Smooth
- GT, TD
- Zubehör
Accessories
- Kalibrieren
Calibration
- Tech. Info

M



DIN 13

Lehrenmaße nach DIN ISO 1502
Gauge dimensions acc. DIN ISO 1502

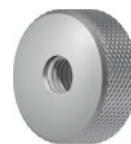
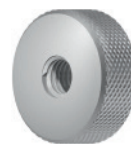
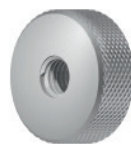
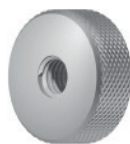

		Toleranz · Tolerance		6g	4h	6e	6g
		Beschichtung · Coating					LH
Werkzeug-Ident · Tool ident				L0200500	L0200510	L0200530	L0200550
		Dimens.-Ident		G-GUT-LR	G-GUT-LR	G-GUT-LR	G-GUT-LR LH
ø d ₁ mm	P mm				„4h“	„6e“	
M 1	0,25	.0010		●*)			
1,1	0,25	.0011		●*)			
1,2	0,25	.0012		●*)			
1,4	0,3	.0014		●*)			
1,6	0,35	.0016		●			
1,7	0,35	.0017		●			
1,8	0,35	.0018		●			
2	0,4	.0020		●	●	●	●
2,2	0,45	.0022		●	●	●	●
2,3	0,4	.0023		●			●
2,5	0,45	.0025		●	●	●	●
2,6	0,45	.0026		●			●
3	0,5	.0030		●	●	●	●
3,5	0,6	.0035		●	●	●	●
4	0,7	.0040		●	●	●	●
4,5	0,75	.0045		●	●	●	●
5	0,8	.0050		●	●	●	●
6	1	.0060		●	●	●	●
7	1	.0070		●			●
8	1,25	.0080		●	●	●	●
9	1,25	.0090		●			
10	1,5	.0100		●	●	●	●
11	1,5	.0111		●			
12	1,75	.0112		●	●	●	●
14	2	.0114		●	●	●	●
16	2	.0116		●	●	●	●
18	2,5	.0118		●	●	●	●
20	2,5	.0120		●	●	●	●
22	2,5	.0122		●	●	●	●
24	3	.0124		●	●	●	●
27	3	.0127		●			
30	3,5	.0130		●			
33	3,5	.0133		●			
36	4	.0136		●			
39	4	.0139		●			
42	4,5	.0142		●			
45	4,5	.0145		●			
48	5	.0148		●			
52	5	.0152		●			
56	5,5	.0156		●			
60	5,5	.0160		●			
64	6	.0164		●			
68	6	.0168		●			

*) ≤ M1,4 Tol. 6h



M



DIN 13

Lehrenmaße nach DIN ISO 1502
Gauge dimensions acc. DIN ISO 1502

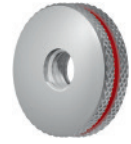
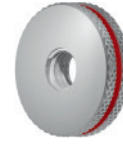

Toleranz · Tolerance
Beschichtung · Coating

6g

4h

6e

6g

LH

Werkzeug-Ident · Tool ident

L0300500

L0300510

L0300530

L0300550

G-AUS-LR

G-AUS-LR

G-AUS-LR

G-AUS-LR
LH

ø d₁
mm

P
mm

Dimens.-
Ident

	ø d ₁ mm	P mm	Dimens.- Ident	L0300500 G-AUS-LR	L0300510 G-AUS-LR „4h“	L0300530 G-AUS-LR „6e“	L0300550 G-AUS-LR LH
M	1	0,25	.0010	●*)			
	1,1	0,25	.0011	●*)			
	1,2	0,25	.0012	●*)			
	1,4	0,3	.0014	●*)			
	1,6	0,35	.0016	●			
	1,7	0,35	.0017	●			
	1,8	0,35	.0018	●			
	2	0,4	.0020	●	●	●	●
	2,2	0,45	.0022	●	●	●	●
	2,3	0,4	.0023	●			●
	2,5	0,45	.0025	●	●	●	●
	2,6	0,45	.0026	●			●
	3	0,5	.0030	●	●	●	●
	3,5	0,6	.0035	●	●	●	●
	4	0,7	.0040	●	●	●	●
	4,5	0,75	.0045	●			●
	5	0,8	.0050	●	●	●	●
	6	1	.0060	●	●	●	●
	7	1	.0070	●			●
	8	1,25	.0080	●	●	●	●
	9	1,25	.0090	●			●
	10	1,5	.0100	●	●	●	●
	11	1,5	.0111	●			●
	12	1,75	.0112	●	●	●	●
	14	2	.0114	●	●	●	●
	16	2	.0116	●	●	●	●
	18	2,5	.0118	●	●	●	●
	20	2,5	.0120	●	●	●	●
	22	2,5	.0122	●	●	●	●
	24	3	.0124	●	●	●	●
	27	3	.0127	●			●
	30	3,5	.0130	●			●
	33	3,5	.0133	●			●
	36	4	.0136	●			●
	39	4	.0139	●			●
	42	4,5	.0142	●			●
	45	4,5	.0145	●			●
	48	5	.0148	●			●
	52	5	.0152	●			●
	56	5,5	.0156	●			●
	60	5,5	.0160	●			●
	64	6	.0164	●			●
	68	6	.0168	●			●

*) ≤ M1,4 Tol. 6h

Product
Finder

M

MF

UNC

UNF

G

Rp
R, Rc

NPT, NPTF

BSW

Pg

MJ
UNJC, UNJF

EG (STI)
SELF-LOCK

Tr, Tr-F
Rd

Glatt
Smooth

GT, TD

Zubehör
Accessories

Kalibrierung
Calibration

Tech. Info



Glatte Kernloch-Grenzlehndorne
siehe Seite 623

Smooth plug gauges go/no-go for thread
holes, see page 623

- Product Finder
- M
- MF**
- UNC
- UNF
- G
- Rp
R, Rc
- NPT, NPTF
- BSW
- Pg
- MJ
UNJC, UNJF
- EG (STI)
SELF-LOCK
- Tr, Tr-F
Rd
- Glatt
Smooth
- GT, TD
- Zubehör
Accessories
- Kalibrieren
Calibration
- Tech. Info

MF

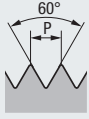

DIN 13

Lehrenmaße nach DIN ISO 1502
Gauge dimensions acc. DIN ISO 1502

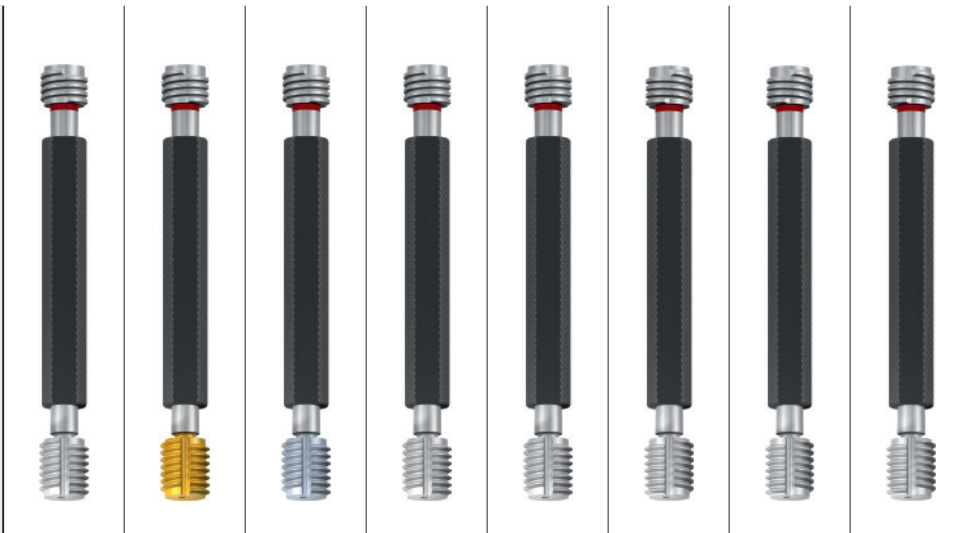

				Toleranz · Tolerance		Beschichtung · Coating						
				6H	6H	6H	4H	6G	6H	4H	6G	
					TIN	CR			LH	LH	LH	
Werkzeug-Ident · Tool ident				L0100100	L0105100	L0101100	L0100110	L0100120	L0100150	L0100160	L0100170	
		Dimens.- Ident	G-GR-LD		G-GR-LD		G-GR-LD		G-GR-LD		G-GR-LD	
ø d ₁ mm	P mm				TIN 1)	CR 1)	„4H“	„6G“	LH	LH	LH	
M	2	x 0,25	.0186				●					
	2,2	x 0,25	.0189				●					
	2,3	x 0,25	.0192				●					
	2,5	x 0,35	.0196	●								
	2,6	x 0,35	.0199	●								
	3	x 0,35	.0202	●					●			
	3,5	x 0,35	.0205	●					●			
	4	x 0,35	.0209	●					●			
	4	x 0,5	.0210	●			●		●			
	4,5	x 0,5	.0214	●			●		●			
	5	x 0,5	.0218	●			●		●			
	6	x 0,5	.0228	●			●		●			
	6	x 0,75	.0229	●			●		●			
	7	x 0,75	.0239	●								
	8	x 0,5	.0249	●								
	8	x 0,75	.0250	●			●		●			
	8	x 1	.0251	●	●	●	●		●	●	●	
	9	x 1	.0263	●			●		●		●	
	10	x 0,75	.0275	●			●		●		●	
	10	x 1	.0276	●	●	●	●		●	●	●	
	10	x 1,25	.0277	●			●		●		●	
	11	x 1	.0288	●			●		●		●	
	12	x 1	.0301	●	●	●	●		●	●	●	
	12	x 1,25	.0302	●			●		●		●	
	12	x 1,5	.0303	●	●	●	●		●	●	●	
	13	x 1	.0315	●			●		●		●	
	13	x 1,5	.0317	●			●		●		●	
	14	x 1	.0329	●			●		●		●	
	14	x 1,25	.0330	●			●		●		●	
	14	x 1,5	.0331	●	●	●	●		●	●	●	
	15	x 1	.0343	●			●		●		●	
	15	x 1,5	.0345	●			●		●		●	
	16	x 1	.0357	●			●		●		●	
	16	x 1,5	.0359	●	●	●	●		●	●	●	
	17	x 1	.0372	●			●		●		●	
	17	x 1,5	.0374	●			●		●		●	
	18	x 1	.0388	●			●		●		●	
	18	x 1,5	.0390	●	●	●	●		●	●	●	
	18	x 2	.0391	●			●		●		●	
	19	x 1	.0404	●			●		●		●	
	20	x 1	.0420	●			●		●		●	
	20	x 1,5	.0422	●	●	●	●		●	●	●	
	20	x 2	.0423	●			●		●		●	
	21	x 1	.0428	●			●		●		●	
	22	x 1	.0436	●			●		●		●	
	22	x 1,5	.0438	●			●		●		●	
	22	x 2	.0439	●			●		●		●	
	23	x 1	.0443	●			●		●		●	
	24	x 1	.0450	●			●		●		●	
	24	x 1,5	.0452	●			●		●		●	
	24	x 2	.0453	●			●		●		●	
	25	x 1	.0456	●			●		●		●	
	25	x 1,5	.0458	●			●		●		●	
	25	x 2	.0459	●			●		●		●	
	26	x 1	.0462	●			●		●		●	
	26	x 1,5	.0464	●			●		●		●	
	26	x 2	.0465	●			●		●		●	

MF

DIN 13

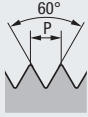

Lehrenmaße nach DIN ISO 1502
Gauge dimensions acc. DIN ISO 1502

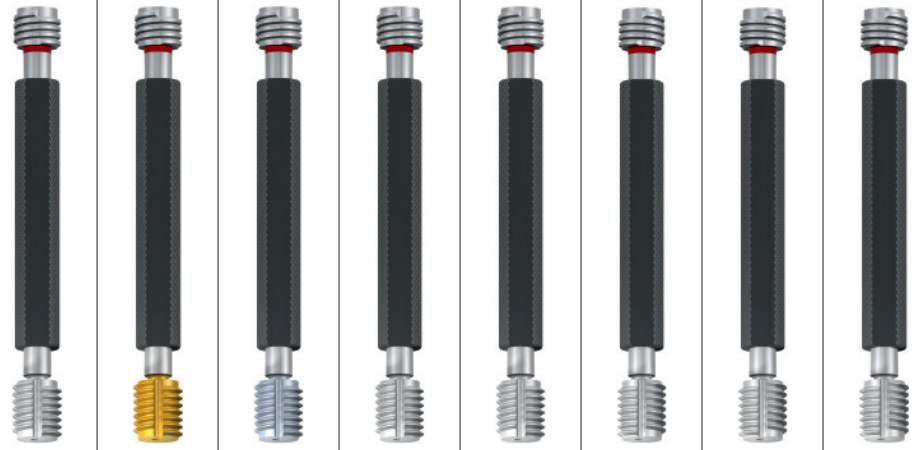

Toleranz · Tolerance
Beschichtung · Coating

6H	6H	6H	4H	6G	6H	4H	6G
	TIN	CR			LH	LH	LH

Werkzeug-Ident · Tool ident

M	ø d ₁ mm	P mm	Dimens.- Ident	L0100100	L0105100	L0101100	L0100110	L0100120	L0100150	L0100160	L0100170
				G-GR-LD	G-GR-LD TIN ¹⁾	G-GR-LD CR ¹⁾	G-GR-LD „4H“	G-GR-LD „6G“	G-GR-LD LH	G-GR-LD LH	G-GR-LD LH
	27	x 1	.0468	●			●	●	●	●	●
	27	x 1,5	.0470	●			●	●	●	●	●
	27	x 2	.0471	●			●	●	●	●	●
	28	x 1	.0474	●			●	●	●	●	●
	28	x 1,5	.0476	●			●	●	●	●	●
	28	x 2	.0477	●			●	●	●	●	●
	30	x 1	.0488	●			●	●	●	●	●
	30	x 1,5	.0490	●			●	●	●	●	●
	30	x 2	.0491	●			●	●	●	●	●
	30	x 3	.0492	●			●	●	●	●	●
	32	x 1	.0502	●			●	●	●	●	●
	32	x 1,5	.0504	●			●	●	●	●	●
	32	x 2	.0505	●			●	●	●	●	●
	33	x 1	.0509	●			●	●	●	●	●
	33	x 1,5	.0511	●			●	●	●	●	●
	33	x 2	.0512	●			●	●	●	●	●
	33	x 3	.0513	●			●	●	●	●	●
	34	x 1	.0516	●			●	●	●	●	●
	34	x 1,5	.0518	●			●	●	●	●	●
	34	x 2	.0519	●			●	●	●	●	●
	35	x 1	.0523	●			●	●	●	●	●
	35	x 1,5	.0525	●			●	●	●	●	●
	35	x 2	.0526	●			●	●	●	●	●
	36	x 1	.0530	●			●	●	●	●	●
	36	x 1,5	.0532	●			●	●	●	●	●
	36	x 2	.0533	●			●	●	●	●	●
	36	x 3	.0534	●			●	●	●	●	●
	38	x 1	.0544	●			●	●	●	●	●
	38	x 1,5	.0546	●			●	●	●	●	●
	38	x 2	.0547	●			●	●	●	●	●
	39	x 1	.0551	●			●	●	●	●	●
	39	x 1,5	.0553	●			●	●	●	●	●
	39	x 2	.0554	●			●	●	●	●	●
	39	x 3	.0555	●			●	●	●	●	●
	40	x 1	.0558	●			●	●	●	●	●
	40	x 1,5	.0560	●			●	●	●	●	●
	40	x 2	.0561	●			●	●	●	●	●
	40	x 3	.0562	●			●	●	●	●	●

> ø 40 nur als Einzellehrdorne erhältlich (G-GUT-LD, G-AUS-LD) siehe Seite 590 - 597
available only as separate plug gauges (G-GUT-LD, G-AUS-LD), see page 590 - 597

¹⁾ Toleranz „4H“ und „6G“ auf Anfrage
Tolerance “4H” and “6G” upon request

- Product Finder
- M
- MF**
- UNC
- UNF
- G
- Rp
R, Rc
- NPT, NPTF
- BSW
- Pg
- MJ
UNJC, UNJF
- EG (STI)
SELF-LOCK
- Tr, Tr-F
Rd
- Glatt
Smooth
- GT, TD
- Zubehör
Accessories
- Kalibrierung
Calibration
- Tech. Info



- Product Finder
- M
- MF**
- UNC
- UNF
- G
- Rp
R, Rc
- NPT, NPTF
- BSW
- Pg
- MJ
UNJC, UNJF
- EG (STI)
SELF-LOCK
- Tr, Tr-F
Rd
- Glatt
Smooth
- GT, TD
- Zubehör
Accessories
- Kalibrieren
Calibration
- Tech. Info

MF



DIN 13

Lehrenmaße nach DIN ISO 1502
Gauge dimensions acc. DIN ISO 1502

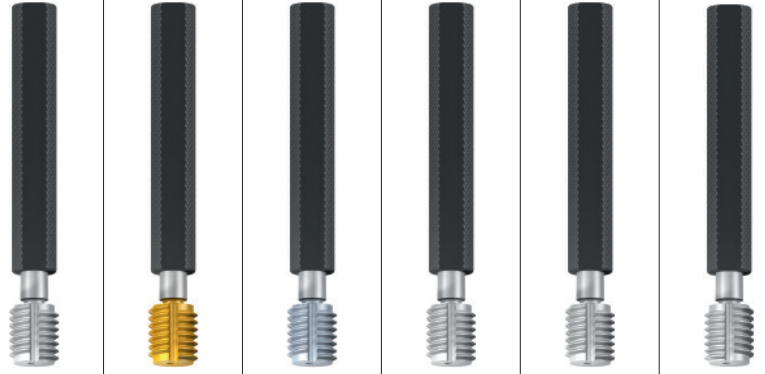

		Toleranz · Tolerance		Beschichtung · Coating											
				6H		6H TIN		6H CR		4H		6G		6H	
														LH	
Werkzeug-Ident · Tool ident			Dimens.-Ident		L0120100	L0125100	L0121100	L0120110	L0120120	L0120150					
					G-GUT-LD	G-GUT-LD TIN	G-GUT-LD CR	G-GUT-LD „4H“	G-GUT-LD „6G“	G-GUT-LD LH					
ø d ₁ mm		P mm													
M	2	x 0,25	.0186												
	2,2	x 0,25	.0189												
	2,3	x 0,25	.0192												
	2,5	x 0,35	.0196												
	2,6	x 0,35	.0199		●										
	3	x 0,35	.0202		●										
	3,5	x 0,35	.0205		●										
	4	x 0,35	.0209		●										
	4	x 0,5	.0210		●										
	4,5	x 0,5	.0214		●										
	5	x 0,5	.0218		●										
	6	x 0,5	.0228		●										
	6	x 0,75	.0229		●										
	7	x 0,75	.0239		●										
	8	x 0,5	.0249		●										
	8	x 0,75	.0250		●										
	8	x 1	.0251		●	●	●	●	●	●				●	
	9	x 1	.0263		●			●	●	●				●	
	10	x 0,75	.0275		●			●	●	●				●	
	10	x 1	.0276		●	●	●	●	●	●				●	
	10	x 1,25	.0277		●										
	11	x 1	.0288		●										
	12	x 1	.0301		●	●	●	●	●	●				●	
	12	x 1,25	.0302		●										
	12	x 1,5	.0303		●	●	●	●	●	●				●	
	13	x 1	.0315		●										
	13	x 1,5	.0317		●										
	14	x 1	.0329		●										
	14	x 1,25	.0330		●										
	14	x 1,5	.0331		●	●	●	●	●	●				●	
	15	x 1	.0343		●										
	15	x 1,5	.0345		●										
	16	x 1	.0357		●										
	16	x 1,5	.0359		●	●	●	●	●	●				●	
	17	x 1	.0372		●										
	17	x 1,5	.0374		●										
	18	x 1	.0388		●										
	18	x 1,5	.0390		●	●	●	●	●	●				●	
	18	x 2	.0391		●										
	19	x 1	.0404		●										
	20	x 1	.0420		●										
	20	x 1,5	.0422		●	●	●	●	●	●				●	
	20	x 2	.0423		●										
	21	x 1	.0428		●										
	22	x 1	.0436		●										
	22	x 1,5	.0438		●										
	22	x 2	.0439		●										
	23	x 1	.0443		●										
	24	x 1	.0450		●										
	24	x 1,5	.0452		●										
	24	x 2	.0453		●										
	25	x 1	.0456		●										
	25	x 1,5	.0458		●										
	25	x 2	.0459		●										
	26	x 1	.0462		●										
	26	x 1,5	.0464		●										
	26	x 2	.0465		●										

4H	6G	6H	4H	6G	6H	4H	6G		
LH	LH				LH	LH	LH		
L0120160	L0120170	L0140100	L0140110	L0140120	L0140150	L0140160	L0140170		
G-GUT-LD LH	G-GUT-LD LH	G-AUS-LD	G-AUS-LD	G-AUS-LD	G-AUS-LD LH	G-AUS-LD LH	G-AUS-LD LH		
„4H“	„6G“		„4H“	„6G“		„4H“	„6G“		
								M 2	x 0,25
									2,2 x 0,25
									2,3 x 0,25
		●							2,5 x 0,35
		●							2,6 x 0,35
		●							3 x 0,35
		●							3,5 x 0,35
		●							4 x 0,35
		●							4 x 0,5
		●							4,5 x 0,5
		●							5 x 0,5
		●							6 x 0,5
		●							6 x 0,75
		●							7 x 0,75
		●							8 x 0,5
		●							8 x 0,75
●	●	●	●	●	●	●	●		8 x 1
●	●	●	●	●	●	●	●		9 x 1
		●							10 x 0,75
●	●	●	●	●	●	●	●		10 x 1
		●							10 x 1,25
●	●	●	●	●	●	●	●		11 x 1
●	●	●	●	●	●	●	●		12 x 1
		●							12 x 1,25
●	●	●	●	●	●	●	●		12 x 1,5
●	●	●	●	●	●	●	●		13 x 1
●	●	●	●	●	●	●	●		13 x 1,5
●	●	●	●	●	●	●	●		14 x 1
		●							14 x 1,25
●	●	●	●	●	●	●	●		14 x 1,5
●	●	●	●	●	●	●	●		15 x 1
●	●	●	●	●	●	●	●		15 x 1,5
●	●	●	●	●	●	●	●		16 x 1
●	●	●	●	●	●	●	●		16 x 1,5
●	●	●	●	●	●	●	●		17 x 1
●	●	●	●	●	●	●	●		17 x 1,5
●	●	●	●	●	●	●	●		18 x 1
●	●	●	●	●	●	●	●		18 x 1,5
		●							18 x 2
●	●	●	●	●	●	●	●		19 x 1
●	●	●	●	●	●	●	●		20 x 1
●	●	●	●	●	●	●	●		20 x 1,5
●	●	●	●	●	●	●	●		20 x 2
●	●	●	●	●	●	●	●		21 x 1
●	●	●	●	●	●	●	●		22 x 1
●	●	●	●	●	●	●	●		22 x 1,5
●	●	●	●	●	●	●	●		22 x 2
●	●	●	●	●	●	●	●		23 x 1
●	●	●	●	●	●	●	●		24 x 1
●	●	●	●	●	●	●	●		24 x 1,5
●	●	●	●	●	●	●	●		24 x 2
●	●	●	●	●	●	●	●		25 x 1
●	●	●	●	●	●	●	●		25 x 1,5
●	●	●	●	●	●	●	●		25 x 2
●	●	●	●	●	●	●	●		26 x 1
●	●	●	●	●	●	●	●		26 x 1,5
●	●	●	●	●	●	●	●		26 x 2

Product Finder

M

MF

UNC

UNF

G

Rp
R, Rc

NPT, NPTF

BSW

Pg

MJ
UNJC, UNJF

EG (STI)
SELF-LOCK

Tr, Tr-F
Rd

Glatt
Smooth

GT, TD

Zubehör
Accessories

Kalibrierung
Calibration

Tech. Info



● = Lagerwerkzeug, siehe Preisliste · Stock tool, see price list
○ = Kurzfristig lieferbar, Preis auf Anfrage · Available on short notice, price upon inquiry

- Product Finder
- M
- MF**
- UNC
- UNF
- G
- Rp
R, Rc
- NPT, NPTF
- BSW
- Pg
- MJ
UNJC, UNJF
- EG (STI)
SELF-LOCK
- Tr, Tr-F
Rd
- Glatt
Smooth
- GT, TD
- Zubehör
Accessories
- Kalibrieren
Calibration
- Tech. Info

MF

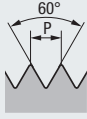

DIN 13

Lehrenmaße nach DIN ISO 1502
Gauge dimensions acc. DIN ISO 1502

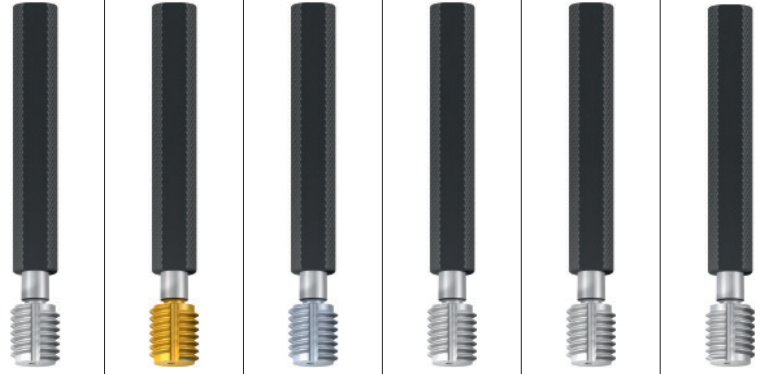

				Toleranz · Tolerance		Beschichtung · Coating									
				6H		6H TIN		6H CR		4H		6G		6H	
Werkzeug-Ident · Tool ident				L0120100		L0125100		L0121100		L0120110		L0120120		L0120150	
				G-GUT-LD		G-GUT-LD TIN		G-GUT-LD CR		G-GUT-LD „4H“		G-GUT-LD „6G“		G-GUT-LD LH	
Ø d ₁ mm	P mm	Dimens.- Ident													
M 27	x 1	.0468		●					●	●	●				
27	x 1,5	.0470		●					●	●	●				
27	x 2	.0471		●					●	●	●				
28	x 1	.0474		●					●	●	●				
28	x 1,5	.0476		●					●	●	●				
28	x 2	.0477		●					●	●	●				
30	x 1	.0488		●					●	●	●				
30	x 1,5	.0490		●					●	●	●				
30	x 2	.0491		●					●	●	●				
30	x 3	.0492		●					●	●	●				
32	x 1	.0502		●					●	●	●				
32	x 1,5	.0504		●					●	●	●				
32	x 2	.0505		●					●	●	●				
33	x 1	.0509		●					●	●	●				
33	x 1,5	.0511		●					●	●	●				
33	x 2	.0512		●					●	●	●				
33	x 3	.0513		●					●	●	●				
34	x 1	.0516		●					●	●	●				
34	x 1,5	.0518		●					●	●	●				
34	x 2	.0519		●					●	●	●				
35	x 1	.0523		●					●	●	●				
35	x 1,5	.0525		●					●	●	●				
35	x 2	.0526		●					●	●	●				
36	x 1	.0530		●					●	●	●				
36	x 1,5	.0532		●					●	●	●				
36	x 2	.0533		●					●	●	●				
36	x 3	.0534		●					●	●	●				
38	x 1	.0544		●					●	●	●				
38	x 1,5	.0546		●					●	●	●				
38	x 2	.0547		●					●	●	●				
39	x 1	.0551		●					●	●	●				
39	x 1,5	.0553		●					●	●	●				
39	x 2	.0554		●					●	●	●				
39	x 3	.0555		●					●	●	●				
40	x 1	.0558		●					●	●	●				
40	x 1,5	.0560		●					●	●	●				
40	x 2	.0561		●					●	●	●				
40	x 3	.0562		●					●	●	●				
42	x 1	.0572		●					●	●	●				
42	x 1,5	.0574		●					●	●	●				
42	x 2	.0575		●					●	●	●				
42	x 3	.0576		●					●	●	●				
45	x 1	.0593		●					●	●	●				
45	x 1,5	.0595		●					●	●	●				
45	x 2	.0596		●					●	●	●				
45	x 3	.0597		●					●	●	●				
48	x 1	.0614		●					●	●	●				
48	x 1,5	.0616		●					●	●	●				
48	x 2	.0617		●					●	●	●				
48	x 3	.0618		●					●	●	●				
50	x 1	.0628		●					●	●	●				
50	x 1,5	.0630		●					●	●	●				
50	x 2	.0631		●					●	●	●				
50	x 3	.0632		●					●	●	●				
52	x 1	.0642		●					●	●	●				
52	x 1,5	.0644		●					●	●	●				
52	x 2	.0645		●					●	●	●				

4H	6G	6H	4H	6G	6H	4H	6G	
LH	LH				LH	LH	LH	
L0120160	L0120170	L0140100	L0140110	L0140120	L0140150	L0140160	L0140170	
G-GUT-LD LH	G-GUT-LD LH	G-AUS-LD	G-AUS-LD	G-AUS-LD	G-AUS-LD LH	G-AUS-LD LH	G-AUS-LD LH	
„4H“	„6G“		„4H“	„6G“		„4H“	„6G“	
●	●	●	●	●	●	●	●	M 27 x 1
●	●	●	●	●	●	●	●	27 x 1,5
●	●	●	●	●	●	●	●	27 x 2
●	●	●	●	●	●	●	●	28 x 1
●	●	●	●	●	●	●	●	28 x 1,5
●	●	●	●	●	●	●	●	28 x 2
●	●	●	●	●	●	●	●	30 x 1
●	●	●	●	●	●	●	●	30 x 1,5
●	●	●	●	●	●	●	●	30 x 2
●	●	●	●	●	●	●	●	30 x 3
●	●	●	●	●	●	●	●	32 x 1
●	●	●	●	●	●	●	●	32 x 1,5
●	●	●	●	●	●	●	●	32 x 2
●	●	●	●	●	●	●	●	33 x 1
●	●	●	●	●	●	●	●	33 x 1,5
●	●	●	●	●	●	●	●	33 x 2
●	●	●	●	●	●	●	●	33 x 3
●	●	●	●	●	●	●	●	34 x 1
●	●	●	●	●	●	●	●	34 x 1,5
●	●	●	●	●	●	●	●	34 x 2
●	●	●	●	●	●	●	●	35 x 1
●	●	●	●	●	●	●	●	35 x 1,5
●	●	●	●	●	●	●	●	35 x 2
●	●	●	●	●	●	●	●	36 x 1
●	●	●	●	●	●	●	●	36 x 1,5
●	●	●	●	●	●	●	●	36 x 2
●	●	●	●	●	●	●	●	36 x 3
●	●	●	●	●	●	●	●	38 x 1
●	●	●	●	●	●	●	●	38 x 1,5
●	●	●	●	●	●	●	●	38 x 2
●	●	●	●	●	●	●	●	39 x 1
●	●	●	●	●	●	●	●	39 x 1,5
●	●	●	●	●	●	●	●	39 x 2
●	●	●	●	●	●	●	●	39 x 3
●	●	●	●	●	●	●	●	40 x 1
●	●	●	●	●	●	●	●	40 x 1,5
●	●	●	●	●	●	●	●	40 x 2
●	●	●	●	●	●	●	●	40 x 3
●	●	●	●	●	●	●	●	42 x 1
●	●	●	●	●	●	●	●	42 x 1,5
●	●	●	●	●	●	●	●	42 x 2
●	●	●	●	●	●	●	●	42 x 3
●	●	●	●	●	●	●	●	45 x 1
●	●	●	●	●	●	●	●	45 x 1,5
●	●	●	●	●	●	●	●	45 x 2
●	●	●	●	●	●	●	●	45 x 3
●	●	●	●	●	●	●	●	48 x 1
●	●	●	●	●	●	●	●	48 x 1,5
●	●	●	●	●	●	●	●	48 x 2
●	●	●	●	●	●	●	●	48 x 3
●	●	●	●	●	●	●	●	50 x 1
●	●	●	●	●	●	●	●	50 x 1,5
●	●	●	●	●	●	●	●	50 x 2
●	●	●	●	●	●	●	●	50 x 3
●	●	●	●	●	●	●	●	52 x 1
●	●	●	●	●	●	●	●	52 x 1,5
●	●	●	●	●	●	●	●	52 x 2

Product Finder

M

MF

UNC

UNF

G

Rp
R, Rc

NPT, NPTF

BSW

Pg

MJ
UNJC, UNJF

EG (STI)
SELF-LOCK

Tr, Tr-F
Rd

Glatt
Smooth

GT, TD

Zubehör
Accessories

Kalibrierung
Calibration

Tech. Info



● = Lagerwerkzeug, siehe Preisliste · Stock tool, see price list
○ = Kurzfristig lieferbar, Preis auf Anfrage · Available on short notice, price upon inquiry

4H	6G	6H	4H	6G	6H	4H	6G	
LH	LH				LH	LH	LH	
L0120160	L0120170	L0140100	L0140110	L0140120	L0140150	L0140160	L0140170	
G-GUT-LD LH	G-GUT-LD LH	G-AUS-LD	G-AUS-LD	G-AUS-LD	G-AUS-LD LH	G-AUS-LD LH	G-AUS-LD LH	
„4H“	„6G“		„4H“	„6G“		„4H“	„6G“	
●	●	●	●	●	●	●	●	M 52 x 3
●	●	●	●	●	●	●	●	55 x 1
●	●	●	●	●	●	●	●	55 x 1,5
●	●	●	●	●	●	●	●	55 x 2
●	●	●	●	●	●	●	●	55 x 3
●	●	●	●	●	●	●	●	56 x 1
●	●	●	●	●	●	●	●	56 x 1,5
●	●	●	●	●	●	●	●	56 x 2
●	●	●	●	●	●	●	●	56 x 3
●	●	●	●	●	●	●	●	58 x 1
●	●	●	●	●	●	●	●	58 x 1,5
●	●	●	●	●	●	●	●	58 x 2
●	●	●	●	●	●	●	●	58 x 3
●	●	●	●	●	●	●	●	60 x 1
●	●	●	●	●	●	●	●	60 x 1,5
●	●	●	●	●	●	●	●	60 x 2
●	●	●	●	●	●	●	●	60 x 3
●	●	●	●	●	●	●	●	62 x 1
●	●	●	●	●	●	●	●	62 x 1,5
●	●	●	●	●	●	●	●	62 x 2
●	●	●	●	●	●	●	●	62 x 3
●	●	●	●	●	●	●	●	64 x 1
●	●	●	●	●	●	●	●	64 x 1,5
●	●	●	●	●	●	●	●	64 x 2
●	●	●	●	●	●	●	●	64 x 3
●	●	●	●	●	●	●	●	65 x 1
●	●	●	●	●	●	●	●	65 x 1,5
●	●	●	●	●	●	●	●	65 x 2
●	●	●	●	●	●	●	●	65 x 3
●	●	●	●	●	●	●	●	68 x 1
●	●	●	●	●	●	●	●	68 x 1,5
●	●	●	●	●	●	●	●	68 x 2
●	●	●	●	●	●	●	●	68 x 3
●	●	●	●	●	●	●	●	70 x 1
●	●	●	●	●	●	●	●	70 x 1,5
●	●	●	●	●	●	●	●	70 x 2
●	●	●	●	●	●	●	●	70 x 3
●	●	●	●	●	●	●	●	72 x 1
●	●	●	●	●	●	●	●	72 x 1,5
●	●	●	●	●	●	●	●	72 x 2
●	●	●	●	●	●	●	●	72 x 3
●	●	●	●	●	●	●	●	75 x 1
●	●	●	●	●	●	●	●	75 x 1,5
●	●	●	●	●	●	●	●	75 x 2
●	●	●	●	●	●	●	●	75 x 3
●	●	●	●	●	●	●	●	76 x 1
●	●	●	●	●	●	●	●	76 x 1,5
●	●	●	●	●	●	●	●	76 x 2
●	●	●	●	●	●	●	●	76 x 3
●	●	●	●	●	●	●	●	78 x 1
●	●	●	●	●	●	●	●	78 x 1,5
●	●	●	●	●	●	●	●	78 x 2
●	●	●	●	●	●	●	●	80 x 1
●	●	●	●	●	●	●	●	80 x 1,5
●	●	●	●	●	●	●	●	80 x 2
●	●	●	●	●	●	●	●	80 x 3
●	●	●	●	●	●	●	●	82 x 1,5

Product Finder

M

MF

UNC

UNF

G

Rp
R, Rc

NPT, NPTF

BSW

Pg

MJ
UNJC, UNJF

EG (STI)
SELF-LOCK

Tr, Tr-F
Rd

Glatt
Smooth

GT, TD

Zubehör
Accessories

Kalibrierung
Calibration

Tech. Info



● = Lagerwerkzeug, siehe Preisliste · Stock tool, see price list
○ = Kurzfristig lieferbar, Preis auf Anfrage · Available on short notice, price upon inquiry

- Product Finder
- M
- MF**
- UNC
- UNF
- G
- Rp
R, Rc
- NPT, NPTF
- BSW
- Pg
- MJ
UNJC, UNJF
- EG (STI)
SELF-LOCK
- Tr, Tr-F
Rd
- Glatt
Smooth
- GT, TD
- Zubehör
Accessories
- Kalibrieren
Calibration
- Tech. Info

MF

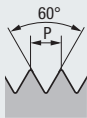

DIN 13

Lehrenmaße nach DIN ISO 1502
Gauge dimensions acc. DIN ISO 1502

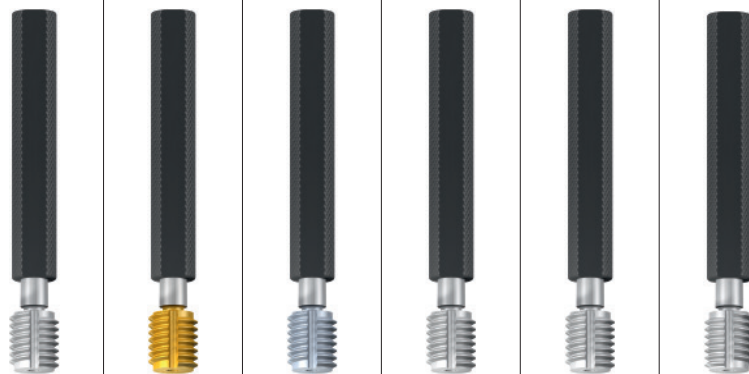

			Toleranz · Tolerance		Beschichtung · Coating					
			6H	6H	6H	4H	6G	6H	LH	
Werkzeug-Ident · Tool ident			L0120100	L0125100	L0121100	L0120110	L0120120	L0120150		
			G-GUT-LD	G-GUT-LD	G-GUT-LD	G-GUT-LD	G-GUT-LD	G-GUT-LD	G-GUT-LD LH	
	Ø d ₁ mm	P mm		TIN	CR	„4H“	„6G“			
M	82	x 2	.0730	●			●	●	●	
	85	x 1,5	.0734	●			●	●	●	
	85	x 2	.0735	●			●	●	●	
	85	x 3	.0736	●			●	●	●	
	88	x 1,5	.0739	●			●	●	●	
	88	x 2	.0740	●			●	●	●	
	90	x 1,5	.0744	●			●	●	●	
	90	x 2	.0745	●			●	●	●	
	90	x 3	.0746	●			●	●	●	
	92	x 1,5	.0749	●			●	●	●	
	92	x 2	.0750	●			●	●	●	
	95	x 1,5	.0754	●			●	●	●	
	95	x 2	.0755	●			●	●	●	
	95	x 3	.0756	●			●	●	●	
	98	x 1,5	.0759	●			●	●	●	
	98	x 2	.0760	●			●	●	●	
	100	x 1,5	.0764	●			●	●	●	
	100	x 2	.0765	●			●	●	●	
100	x 3	.0766	●			●	●	●		

← M52 x 3 - M82 x 1,5



Kalibrierdienstleistung für Lehren und
Messmittel siehe Seite 631 - 633

Calibration service for gauges and
measuring tools, see page 631 - 633

								Product Finder
4H	6G	6H	4H	6G	6H	4H	6G	M
LH	LH				LH	LH	LH	MF
L0120160	L0120170	L0140100	L0140110	L0140120	L0140150	L0140160	L0140170	UNC
G-GUT-LD LH	G-GUT-LD LH	G-AUS-LD	G-AUS-LD	G-AUS-LD	G-AUS-LD LH	G-AUS-LD LH	G-AUS-LD LH	UNF
„4H“	„6G“		„4H“	„6G“		„4H“	„6G“	G
●	●	●	●	●	●	●	●	Rp
●	●	●	●	●	●	●	●	R, Rc
●	●	●	●	●	●	●	●	NPT, NPTF
●	●	●	●	●	●	●	●	BSW
●	●	●	●	●	●	●	●	Pg
●	●	●	●	●	●	●	●	MJ
●	●	●	●	●	●	●	●	UNJC, UNJF
●	●	●	●	●	●	●	●	EG (STI) SELF-LOCK
●	●	●	●	●	●	●	●	Tr, Tr-F Rd
●	●	●	●	●	●	●	●	Glatt Smooth
●	●	●	●	●	●	●	●	GT, TD
●	●	●	●	●	●	●	●	Zubehör Accessories
●	●	●	●	●	●	●	●	Kalibrierung Calibration
●	●	●	●	●	●	●	●	Tech. Info
●	●	●	●	●	●	●	●	M 82 x 2
●	●	●	●	●	●	●	●	85 x 1,5
●	●	●	●	●	●	●	●	85 x 2
●	●	●	●	●	●	●	●	85 x 3
●	●	●	●	●	●	●	●	88 x 1,5
●	●	●	●	●	●	●	●	88 x 2
●	●	●	●	●	●	●	●	90 x 1,5
●	●	●	●	●	●	●	●	90 x 2
●	●	●	●	●	●	●	●	90 x 3
●	●	●	●	●	●	●	●	92 x 1,5
●	●	●	●	●	●	●	●	92 x 2
●	●	●	●	●	●	●	●	95 x 1,5
●	●	●	●	●	●	●	●	95 x 2
●	●	●	●	●	●	●	●	95 x 3
●	●	●	●	●	●	●	●	98 x 1,5
●	●	●	●	●	●	●	●	98 x 2
●	●	●	●	●	●	●	●	100 x 1,5
●	●	●	●	●	●	●	●	100 x 2
●	●	●	●	●	●	●	●	100 x 3

- Product Finder
- M
- MF
- UNC
- UNF
- G
- Rp
- R, Rc
- NPT, NPTF
- BSW
- Pg
- MJ
- UNJC, UNJF
- EG (STI) SELF-LOCK
- Tr, Tr-F Rd
- Glatt Smooth
- GT, TD
- Zubehör Accessories
- Kalibrierung Calibration
- Tech. Info



- Product Finder
- M
- MF**
- UNC
- UNF
- G
- Rp
R, Rc
- NPT, NPTF
- BSW
- Pg
- MJ
UNJC, UNJF
- EG (STI)
SELF-LOCK
- Tr, Tr-F
Rd
- Glatt
Smooth
- GT, TD
- Zubehör
Accessories
- Kalibrieren
Calibration
- Tech. Info

MF



DIN 13

Lehrenmaße nach DIN ISO 1502
Gauge dimensions acc. DIN ISO 1502

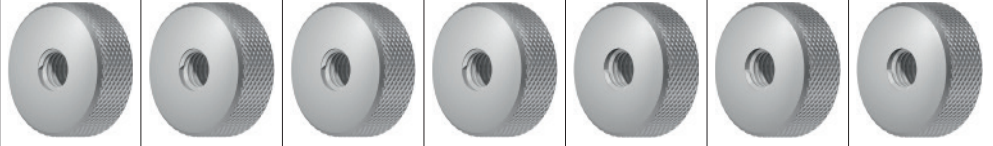

				Toleranz · Tolerance		Beschichtung · Coating							
				6g	4h	6h	6e	6g	4h	6e	LH	LH	LH
Werkzeug-Ident · Tool ident				L0200500	L0200510	L0200501	L0200530	L0200550	L0200560	L0200580			
ø d ₁ mm		P mm	Dimens.- Ident	G-GUT-LR	G-GUT-LR „4h“	G-GUT-LR „6h“	G-GUT-LR „6e“	G-GUT-LR LH 1)	G-GUT-LR LH	G-GUT-LR LH			
M	2	x 0,25	.0186		•								
	2,2	x 0,25	.0189		•								
	2,3	x 0,25	.0192		•								
	2,5	x 0,35	.0196	•									
	2,6	x 0,35	.0199	•									
	3	x 0,35	.0202	•				•					
	3,5	x 0,35	.0205	•				•					
	4	x 0,35	.0209	•				•					
	4	x 0,5	.0210	•	•			•					
	4,5	x 0,5	.0214	•			•	•					
	5	x 0,5	.0218	•	•		•	•					
	6	x 0,5	.0228	•	•		•	•					
	6	x 0,75	.0229	•	•		•	•					
	7	x 0,75	.0239	•									
	8	x 0,5	.0249	•									
	8	x 0,75	.0250	•	•		•	•					
	8	x 1	.0251	•	•	•	•	•	•			•	•
	9	x 1	.0263	•	•	•	•	•	•	•		•	•
	10	x 0,75	.0275	•									
	10	x 1	.0276	•	•	•	•	•	•	•		•	•
	10	x 1,25	.0277	•									
	11	x 1	.0288	•	•	•	•	•	•	•		•	•
	12	x 1	.0301	•	•	•	•	•	•	•		•	•
	12	x 1,25	.0302	•									
	12	x 1,5	.0303	•	•	•	•	•	•	•		•	•
	13	x 1	.0315	•	•	•	•	•	•	•		•	•
	13	x 1,5	.0317	•	•	•	•	•	•	•		•	•
	14	x 1	.0329	•	•	•	•	•	•	•		•	•
	14	x 1,25	.0330	•									
	14	x 1,5	.0331	•	•	•	•	•	•	•		•	•
	15	x 1	.0343	•	•	•	•	•	•	•		•	•
	15	x 1,5	.0345	•	•	•	•	•	•	•		•	•
	16	x 1	.0357	•	•	•	•	•	•	•		•	•
	16	x 1,5	.0359	•	•	•	•	•	•	•		•	•
	17	x 1	.0372	•	•	•	•	•	•	•		•	•
	17	x 1,5	.0374	•	•	•	•	•	•	•		•	•
	18	x 1	.0388	•	•	•	•	•	•	•		•	•
	18	x 1,5	.0390	•	•	•	•	•	•	•		•	•
	18	x 2	.0391	•	•	•	•	•	•	•		•	•
	19	x 1	.0404	•	•	•	•	•	•	•		•	•
	20	x 1	.0420	•	•	•	•	•	•	•		•	•
	20	x 1,5	.0422	•	•	•	•	•	•	•		•	•
	20	x 2	.0423	•	•	•	•	•	•	•		•	•
	21	x 1	.0428	•	•	•	•	•	•	•		•	•
	22	x 1	.0436	•	•	•	•	•	•	•		•	•
	22	x 1,5	.0438	•	•	•	•	•	•	•		•	•
	22	x 2	.0439	•	•	•	•	•	•	•		•	•
	23	x 1	.0443	•	•	•	•	•	•	•		•	•
	24	x 1	.0450	•	•	•	•	•	•	•		•	•
	24	x 1,5	.0452	•	•	•	•	•	•	•		•	•
	24	x 2	.0453	•	•	•	•	•	•	•		•	•
	25	x 1	.0456	•	•	•	•	•	•	•		•	•
	25	x 1,5	.0458	•	•	•	•	•	•	•		•	•
	25	x 2	.0459	•	•	•	•	•	•	•		•	•
	26	x 1	.0462	•	•	•	•	•	•	•		•	•
	26	x 1,5	.0464	•	•	•	•	•	•	•		•	•
	26	x 2	.0465	•	•	•	•	•	•	•		•	•

Product Finder

M

MF

UNC

UNF

G

Rp
R, Rc

NPT, NPTF

BSW

Pg

MJ
UNJC, UNJF

EG (STI)
SELF-LOCK

Tr, Tr-F
Rd



Glatt
Smooth

GT, TD

Zubehör
Accessories

Kalibrierung
Calibration

Tech. Info

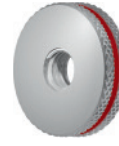
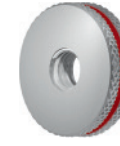
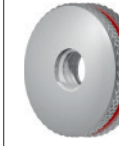
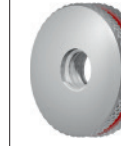
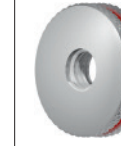
								
	6g	4h	6h	6e	6g LH	4h LH	6e LH	
	L0300500	L0300510	L0300501	L0300530	L0300550	L0300560	L0300580	
	G-AUS-LR	G-AUS-LR „4h“	G-AUS-LR „6h“	G-AUS-LR „6e“	G-AUS-LR LH 1)	G-AUS-LR LH „4h“	G-AUS-LR LH „6e“	
		●						M 2 x 0,25
		●						2,2 x 0,25
		●						2,3 x 0,25
●								2,5 x 0,35
●					●			2,6 x 0,35
●					●			3 x 0,35
●					●			3,5 x 0,35
●					●			4 x 0,35
●		●		●	●			4 x 0,5
●		●		●	●			4,5 x 0,5
●		●		●	●			5 x 0,5
●		●		●	●			6 x 0,5
●		●		●	●			6 x 0,75
●		●		●	●			7 x 0,75
●		●		●	●			8 x 0,5
●		●		●	●			8 x 0,75
●		●	●	●	●	●	●	8 x 1
●		●	●	●	●	●	●	9 x 1
●		●	●	●	●	●	●	10 x 0,75
●		●	●	●	●	●	●	10 x 1
●		●	●	●	●	●	●	10 x 1,25
●		●	●	●	●	●	●	11 x 1
●		●	●	●	●	●	●	12 x 1
●		●	●	●	●	●	●	12 x 1,25
●		●	●	●	●	●	●	12 x 1,5
●		●	●	●	●	●	●	13 x 1
●		●	●	●	●	●	●	13 x 1,5
●		●	●	●	●	●	●	14 x 1
●		●	●	●	●	●	●	14 x 1,25
●		●	●	●	●	●	●	14 x 1,5
●		●	●	●	●	●	●	15 x 1
●		●	●	●	●	●	●	15 x 1,5
●		●	●	●	●	●	●	16 x 1
●		●	●	●	●	●	●	16 x 1,5
●		●	●	●	●	●	●	17 x 1
●		●	●	●	●	●	●	17 x 1,5
●		●	●	●	●	●	●	18 x 1
●		●	●	●	●	●	●	18 x 1,5
●		●	●	●	●	●	●	18 x 2
●		●	●	●	●	●	●	19 x 1
●		●	●	●	●	●	●	20 x 1
●		●	●	●	●	●	●	20 x 1,5
●		●	●	●	●	●	●	20 x 2
●		●	●	●	●	●	●	21 x 1
●		●	●	●	●	●	●	22 x 1
●		●	●	●	●	●	●	22 x 1,5
●		●	●	●	●	●	●	22 x 2
●		●	●	●	●	●	●	23 x 1
●		●	●	●	●	●	●	24 x 1
●		●	●	●	●	●	●	24 x 1,5
●		●	●	●	●	●	●	24 x 2
●		●	●	●	●	●	●	25 x 1
●		●	●	●	●	●	●	25 x 1,5
●		●	●	●	●	●	●	25 x 2
●		●	●	●	●	●	●	26 x 1
●		●	●	●	●	●	●	26 x 1,5
●		●	●	●	●	●	●	26 x 2

● = Lagerwerkzeug, siehe Preisliste · Stock tool, see price list
○ = Kurzfristig lieferbar, Preis auf Anfrage · Available on short notice, price upon inquiry



- Product Finder
- M
- MF**
- UNC
- UNF
- G
- Rp
R, Rc
- NPT, NPTF
- BSW
- Pg
- MJ
UNJC, UNJF
- EG (STI)
SELF-LOCK
- Tr, Tr-F
Rd
- Glatt
Smooth
- GT, TD
- Zubehör
Accessories
- Kalibrieren
Calibration
- Tech. Info

MF

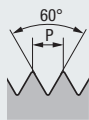

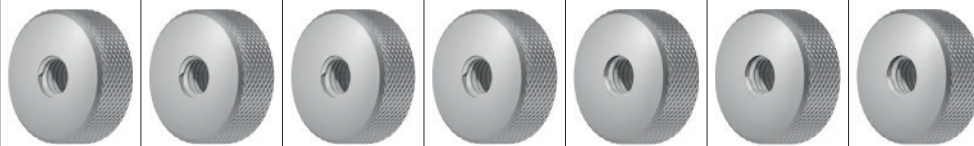

DIN 13

Lehrenmaße nach DIN ISO 1502
Gauge dimensions acc. DIN ISO 1502

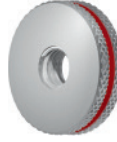
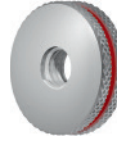
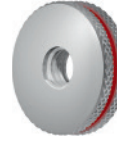
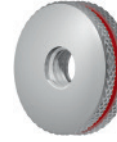

				Toleranz · Tolerance		Beschichtung · Coating							
				6g	4h	6h	6e	6g	4h	6e	LH	LH	LH
Werkzeug-Ident · Tool ident				L0200500	L0200510	L0200501	L0200530	L0200550	L0200560	L0200580			
ø d ₁ mm		P mm	Dimens.- Ident	G-GUT-LR	G-GUT-LR „4h“	G-GUT-LR „6h“	G-GUT-LR „6e“	G-GUT-LR LH 1)	G-GUT-LR LH	G-GUT-LR LH			
M	27	x 1	.0468	●	●	●	●	●	●	●			
	27	x 1,5	.0470	●	●	●	●	●	●	●			
	27	x 2	.0471	●	●	●	●	●	●	●			
	28	x 1	.0474	●	●	●	●	●	●	●			
	28	x 1,5	.0476	●	●	●	●	●	●	●			
	28	x 2	.0477	●	●	●	●	●	●	●			
	30	x 1	.0488	●	●	●	●	●	●	●			
	30	x 1,5	.0490	●	●	●	●	●	●	●			
	30	x 2	.0491	●	●	●	●	●	●	●			
	30	x 3	.0492	●	●	●	●	●	●	●			
	32	x 1	.0502	●	●	●	●	●	●	●			
	32	x 1,5	.0504	●	●	●	●	●	●	●			
	32	x 2	.0505	●	●	●	●	●	●	●			
	33	x 1	.0509	●	●	●	●	●	●	●			
	33	x 1,5	.0511	●	●	●	●	●	●	●			
	33	x 2	.0512	●	●	●	●	●	●	●			
	33	x 3	.0513	●	●	●	●	●	●	●			
	34	x 1	.0516	●	●	●	●	●	●	●			
	34	x 1,5	.0518	●	●	●	●	●	●	●			
	34	x 2	.0519	●	●	●	●	●	●	●			
	35	x 1	.0523	●	●	●	●	●	●	●			
	35	x 1,5	.0525	●	●	●	●	●	●	●			
	35	x 2	.0526	●	●	●	●	●	●	●			
	36	x 1	.0530	●	●	●	●	●	●	●			
	36	x 1,5	.0532	●	●	●	●	●	●	●			
	36	x 2	.0533	●	●	●	●	●	●	●			
	36	x 3	.0534	●	●	●	●	●	●	●			
	38	x 1	.0544	●	●	●	●	●	●	●			
	38	x 1,5	.0546	●	●	●	●	●	●	●			
	38	x 2	.0547	●	●	●	●	●	●	●			
	39	x 1	.0551	●	●	●	●	●	●	●			
	39	x 1,5	.0553	●	●	●	●	●	●	●			
	39	x 2	.0554	●	●	●	●	●	●	●			
	39	x 3	.0555	●	●	●	●	●	●	●			
	40	x 1	.0558	●	●	●	●	●	●	●			
	40	x 1,5	.0560	●	●	●	●	●	●	●			
	40	x 2	.0561	●	●	●	●	●	●	●			
	40	x 3	.0562	●	●	●	●	●	●	●			
	42	x 1	.0572	●	●	●	●	●	●	●			
	42	x 1,5	.0574	●	●	●	●	●	●	●			
	42	x 2	.0575	●	●	●	●	●	●	●			
	42	x 3	.0576	●	●	●	●	●	●	●			
	45	x 1	.0593	●	●	●	●	●	●	●			
	45	x 1,5	.0595	●	●	●	●	●	●	●			
	45	x 2	.0596	●	●	●	●	●	●	●			
	45	x 3	.0597	●	●	●	●	●	●	●			
	48	x 1	.0614	●	●	●	●	●	●	●			
	48	x 1,5	.0616	●	●	●	●	●	●	●			
	48	x 2	.0617	●	●	●	●	●	●	●			
	48	x 3	.0618	●	●	●	●	●	●	●			
	50	x 1	.0628	●	●	●	●	●	●	●			
	50	x 1,5	.0630	●	●	●	●	●	●	●			
	50	x 2	.0631	●	●	●	●	●	●	●			
	50	x 3	.0632	●	●	●	●	●	●	●			
	52	x 1	.0642	●	●	●	●	●	●	●			
	52	x 1,5	.0644	●	●	●	●	●	●	●			
	52	x 2	.0645	●	●	●	●	●	●	●			

							
6g	4h	6h	6e	6g LH	4h LH	6e LH	
L0300500	L0300510	L0300501	L0300530	L0300550	L0300560	L0300580	
G-AUS-LR	G-AUS-LR „4h“	G-AUS-LR „6h“	G-AUS-LR „6e“	G-AUS-LR LH 1)	G-AUS-LR LH „4h“	G-AUS-LR LH „6e“	
•	•	•	•	•	•	•	M 27 x 1
•	•	•	•	•	•	•	27 x 1,5
•	•	•	•	•	•	•	27 x 2
•	•	•	•	•	•	•	28 x 1
•	•	•	•	•	•	•	28 x 1,5
•	•	•	•	•	•	•	28 x 2
•	•	•	•	•	•	•	30 x 1
•	•	•	•	•	•	•	30 x 1,5
•	•	•	•	•	•	•	30 x 2
•	•	•	•	•	•	•	30 x 3
•	•	•	•	•	•	•	32 x 1
•	•	•	•	•	•	•	32 x 1,5
•	•	•	•	•	•	•	32 x 2
•	•	•	•	•	•	•	33 x 1
•	•	•	•	•	•	•	33 x 1,5
•	•	•	•	•	•	•	33 x 2
•	•	•	•	•	•	•	33 x 3
•	•	•	•	•	•	•	34 x 1
•	•	•	•	•	•	•	34 x 1,5
•	•	•	•	•	•	•	34 x 2
•	•	•	•	•	•	•	35 x 1
•	•	•	•	•	•	•	35 x 1,5
•	•	•	•	•	•	•	35 x 2
•	•	•	•	•	•	•	36 x 1
•	•	•	•	•	•	•	36 x 1,5
•	•	•	•	•	•	•	36 x 2
•	•	•	•	•	•	•	36 x 3
•	•	•	•	•	•	•	38 x 1
•	•	•	•	•	•	•	38 x 1,5
•	•	•	•	•	•	•	38 x 2
•	•	•	•	•	•	•	39 x 1
•	•	•	•	•	•	•	39 x 1,5
•	•	•	•	•	•	•	39 x 2
•	•	•	•	•	•	•	39 x 3
•	•	•	•	•	•	•	40 x 1
•	•	•	•	•	•	•	40 x 1,5
•	•	•	•	•	•	•	40 x 2
•	•	•	•	•	•	•	40 x 3
•	•	•	•	•	•	•	42 x 1
•	•	•	•	•	•	•	42 x 1,5
•	•	•	•	•	•	•	42 x 2
•	•	•	•	•	•	•	42 x 3
•	•	•	•	•	•	•	45 x 1
•	•	•	•	•	•	•	45 x 1,5
•	•	•	•	•	•	•	45 x 2
•	•	•	•	•	•	•	45 x 3
•	•	•	•	•	•	•	48 x 1
•	•	•	•	•	•	•	48 x 1,5
•	•	•	•	•	•	•	48 x 2
•	•	•	•	•	•	•	48 x 3
•	•	•	•	•	•	•	50 x 1
•	•	•	•	•	•	•	50 x 1,5
•	•	•	•	•	•	•	50 x 2
•	•	•	•	•	•	•	50 x 3
•	•	•	•	•	•	•	52 x 1
•	•	•	•	•	•	•	52 x 1,5
•	•	•	•	•	•	•	52 x 2

- Product Finder
- M
- MF**
- UNC
- UNF
- G
- Rp
R, Rc
- NPT, NPTF
- BSW
- Pg
- MJ
UNJC, UNJF
- EG (STI)
SELF-LOCK
- Tr, Tr-F
Rd
- Glatt
Smooth
- GT, TD
- Zubehör
Accessories
- Kalibrierung
Calibration
- Tech. Info



• = Lagerwerkzeug, siehe Preisliste · Stock tool, see price list
 ○ = Kurzfristig lieferbar, Preis auf Anfrage · Available on short notice, price upon inquiry

- Product Finder
- M
- MF**
- UNC
- UNF
- G
- Rp
R, Rc
- NPT, NPTF
- BSW
- Pg
- MJ
UNJC, UNJF
- EG (STI)
SELF-LOCK
- Tr, Tr-F
Rd
- Glatt
Smooth
- GT, TD
- Zubehör
Accessories
- Kalibrieren
Calibration
- Tech. Info

MF



DIN 13

Lehrenmaße nach DIN ISO 1502
Gauge dimensions acc. DIN ISO 1502

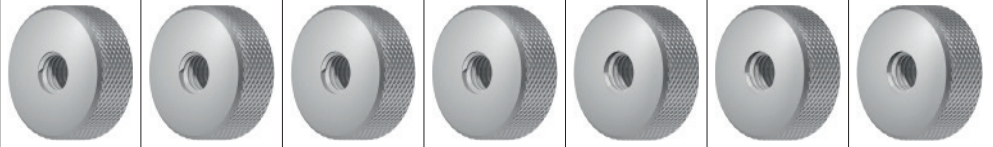

				Toleranz · Tolerance		Beschichtung · Coating							
				6g	4h	6h	6e	6g	4h	6e	LH	LH	LH
Werkzeug-Ident · Tool ident				L0200500	L0200510	L0200501	L0200530	L0200550	L0200560	L0200580			
ø d ₁ mm		P mm	Dimens.- Ident	G-GUT-LR	G-GUT-LR „4h“	G-GUT-LR „6h“	G-GUT-LR „6e“	G-GUT-LR LH 1)	G-GUT-LR LH	G-GUT-LR LH			
M	52	x	3	.0646	•	•	•	•	•	•			
	55	x	1	.0653	•	•	•	•	•	•			
	55	x	1,5	.0654	•	•	•	•	•	•			
	55	x	2	.0655	•	•	•	•	•	•			
	55	x	3	.0656	•	•	•	•	•	•			
	56	x	1	.0658	•	•	•	•	•	•			
	56	x	1,5	.0659	•	•	•	•	•	•			
	56	x	2	.0660	•	•	•	•	•	•			
	56	x	3	.0661	•	•	•	•	•	•			
	58	x	1	.0663	•	•	•	•	•	•			
	58	x	1,5	.0664	•	•	•	•	•	•			
	58	x	2	.0665	•	•	•	•	•	•			
	58	x	3	.0666	•	•	•	•	•	•			
	60	x	1	.0668	•	•	•	•	•	•			
	60	x	1,5	.0669	•	•	•	•	•	•			
	60	x	2	.0670	•	•	•	•	•	•			
	60	x	3	.0671	•	•	•	•	•	•			
	62	x	1	.0673	•	•	•	•	•	•			
	62	x	1,5	.0674	•	•	•	•	•	•			
	62	x	2	.0675	•	•	•	•	•	•			
	62	x	3	.0676	•	•	•	•	•	•			
	64	x	1	.0678	•	•	•	•	•	•			
	64	x	1,5	.0679	•	•	•	•	•	•			
	64	x	2	.0680	•	•	•	•	•	•			
	64	x	3	.0681	•	•	•	•	•	•			
	65	x	1	.0683	•	•	•	•	•	•			
	65	x	1,5	.0684	•	•	•	•	•	•			
	65	x	2	.0685	•	•	•	•	•	•			
	65	x	3	.0686	•	•	•	•	•	•			
	68	x	1	.0688	•	•	•	•	•	•			
	68	x	1,5	.0689	•	•	•	•	•	•			
	68	x	2	.0690	•	•	•	•	•	•			
	68	x	3	.0691	•	•	•	•	•	•			
	70	x	1	.0693	•	•	•	•	•	•			
	70	x	1,5	.0694	•	•	•	•	•	•			
	70	x	2	.0695	•	•	•	•	•	•			
	70	x	3	.0696	•	•	•	•	•	•			
	72	x	1	.0699	•	•	•	•	•	•			
	72	x	1,5	.0700	•	•	•	•	•	•			
	72	x	2	.0701	•	•	•	•	•	•			
	72	x	3	.0702	•	•	•	•	•	•			
	75	x	1	.0705	•	•	•	•	•	•			
	75	x	1,5	.0706	•	•	•	•	•	•			
	75	x	2	.0707	•	•	•	•	•	•			
	75	x	3	.0708	•	•	•	•	•	•			
	76	x	1	.0711	•	•	•	•	•	•			
	76	x	1,5	.0712	•	•	•	•	•	•			
	76	x	2	.0713	•	•	•	•	•	•			
	76	x	3	.0714	•	•	•	•	•	•			
	78	x	1	.0717	•	•	•	•	•	•			
	78	x	1,5	.0718	•	•	•	•	•	•			
	78	x	2	.0719	•	•	•	•	•	•			
	80	x	1	.0723	•	•	•	•	•	•			
	80	x	1,5	.0724	•	•	•	•	•	•			
	80	x	2	.0725	•	•	•	•	•	•			
	80	x	3	.0726	•	•	•	•	•	•			
	82	x	1,5	.0729	•	•	•	•	•	•			

Product Finder

M

MF

UNC

UNF

G

Rp
R, Rc

NPT, NPTF

BSW

Pg

MJ
UNJC, UNJF

EG (STI)
SELF-LOCK

Tr, Tr-F
Rd



Glatt
Smooth

GT, TD

Zubehör
Accessories

Kalibrierung
Calibration

Tech. Info

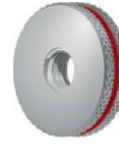
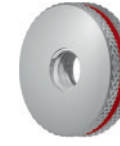
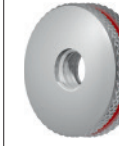
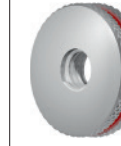
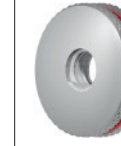
								
	6g	4h	6h	6e	6g LH	4h LH	6e LH	
	L0300500	L0300510	L0300501	L0300530	L0300550	L0300560	L0300580	
	G-AUS-LR	G-AUS-LR „4h“	G-AUS-LR „6h“	G-AUS-LR „6e“	G-AUS-LR LH 1)	G-AUS-LR LH „4h“	G-AUS-LR LH „6e“	
●	●	●	●	●	●	●	●	M 52 x 3
●	●	●	●	●	●	●	●	55 x 1
●	●	●	●	●	●	●	●	55 x 1,5
●	●	●	●	●	●	●	●	55 x 2
●	●	●	●	●	●	●	●	55 x 3
●	●	●	●	●	●	●	●	56 x 1
●	●	●	●	●	●	●	●	56 x 1,5
●	●	●	●	●	●	●	●	56 x 2
●	●	●	●	●	●	●	●	56 x 3
●	●	●	●	●	●	●	●	58 x 1
●	●	●	●	●	●	●	●	58 x 1,5
●	●	●	●	●	●	●	●	58 x 2
●	●	●	●	●	●	●	●	58 x 3
●	●	●	●	●	●	●	●	60 x 1
●	●	●	●	●	●	●	●	60 x 1,5
●	●	●	●	●	●	●	●	60 x 2
●	●	●	●	●	●	●	●	60 x 3
●	●	●	●	●	●	●	●	62 x 1
●	●	●	●	●	●	●	●	62 x 1,5
●	●	●	●	●	●	●	●	62 x 2
●	●	●	●	●	●	●	●	62 x 3
●	●	●	●	●	●	●	●	64 x 1
●	●	●	●	●	●	●	●	64 x 1,5
●	●	●	●	●	●	●	●	64 x 2
●	●	●	●	●	●	●	●	64 x 3
●	●	●	●	●	●	●	●	65 x 1
●	●	●	●	●	●	●	●	65 x 1,5
●	●	●	●	●	●	●	●	65 x 2
●	●	●	●	●	●	●	●	65 x 3
●	●	●	●	●	●	●	●	68 x 1
●	●	●	●	●	●	●	●	68 x 1,5
●	●	●	●	●	●	●	●	68 x 2
●	●	●	●	●	●	●	●	68 x 3
●	●	●	●	●	●	●	●	70 x 1
●	●	●	●	●	●	●	●	70 x 1,5
●	●	●	●	●	●	●	●	70 x 2
●	●	●	●	●	●	●	●	70 x 3
●	●	●	●	●	●	●	●	72 x 1
●	●	●	●	●	●	●	●	72 x 1,5
●	●	●	●	●	●	●	●	72 x 2
●	●	●	●	●	●	●	●	72 x 3
●	●	●	●	●	●	●	●	75 x 1
●	●	●	●	●	●	●	●	75 x 1,5
●	●	●	●	●	●	●	●	75 x 2
●	●	●	●	●	●	●	●	75 x 3
●	●	●	●	●	●	●	●	76 x 1
●	●	●	●	●	●	●	●	76 x 1,5
●	●	●	●	●	●	●	●	76 x 2
●	●	●	●	●	●	●	●	76 x 3
●	●	●	●	●	●	●	●	78 x 1
●	●	●	●	●	●	●	●	78 x 1,5
●	●	●	●	●	●	●	●	78 x 2
●	●	●	●	●	●	●	●	80 x 1
●	●	●	●	●	●	●	●	80 x 1,5
●	●	●	●	●	●	●	●	80 x 2
●	●	●	●	●	●	●	●	80 x 3
●	●	●	●	●	●	●	●	82 x 1,5

● = Lagerwerkzeug, siehe Preisliste · Stock tool, see price list
○ = Kurzfristig lieferbar, Preis auf Anfrage · Available on short notice, price upon inquiry



- Product Finder
- M
- MF**
- UNC
- UNF
- G
- Rp
R, Rc
- NPT, NPTF
- BSW
- Pg
- MJ
UNJC, UNJF
- EG (STI)
SELF-LOCK
- Tr, Tr-F
Rd
- Glatt
Smooth
- GT, TD
- Zubehör
Accessories
- Kalibrieren
Calibration
- Tech. Info

MF



DIN 13

Lehrenmaße nach DIN ISO 1502
Gauge dimensions acc. DIN ISO 1502

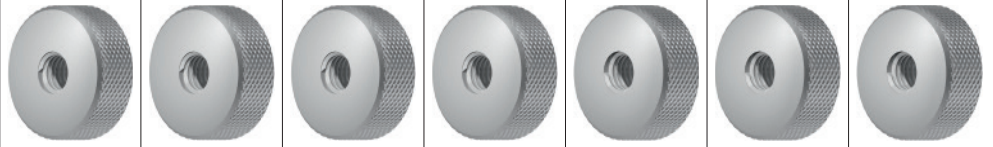



				Toleranz · Tolerance		Beschichtung · Coating					
				6g	4h	6h	6e	6g	4h	6e	
								LH	LH	LH	
Werkzeug-Ident · Tool ident				L0200500	L0200510	L0200501	L0200530	L0200550	L0200560	L0200580	
		Ø d ₁ mm	P mm	Dimens.- Ident	G-GUT-LR	G-GUT-LR	G-GUT-LR	G-GUT-LR	G-GUT-LR LH 1)	G-GUT-LR LH	G-GUT-LR LH
M	82	x	2	.0730	●	●	●	●	●	●	●
	85	x	1,5	.0734	●	●	●	●	●	●	●
	85	x	2	.0735	●	●	●	●	●	●	●
	85	x	3	.0736	●	●	●	●	●	●	●
	88	x	1,5	.0739	●	●	●	●	●	●	●
	88	x	2	.0740	●	●	●	●	●	●	●
	90	x	1,5	.0744	●	●	●	●	●	●	●
	90	x	2	.0745	●	●	●	●	●	●	●
	90	x	3	.0746	●	●	●	●	●	●	●
	92	x	1,5	.0749	●	●	●	●	●	●	●
	92	x	2	.0750	●	●	●	●	●	●	●
	95	x	1,5	.0754	●	●	●	●	●	●	●
	95	x	2	.0755	●	●	●	●	●	●	●
	95	x	3	.0756	●	●	●	●	●	●	●
	98	x	1,5	.0759	●	●	●	●	●	●	●
	98	x	2	.0760	●	●	●	●	●	●	●
	100	x	1,5	.0764	●	●	●	●	●	●	●
	100	x	2	.0765	●	●	●	●	●	●	●
	100	x	3	.0766	●	●	●	●	●	●	●

← M52 x 3 - M82 x 1,5

1) Toleranz „6h“ auf Anfrage
Tolerance „6h“ upon request

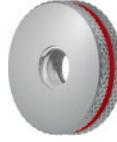
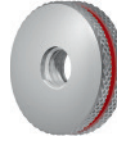
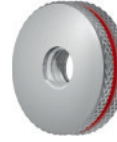
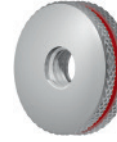

							
6g	4h	6h	6e	6g	4h	6e	
				LH	LH	LH	
L0300500	L0300510	L0300501	L0300530	L0300550	L0300560	L0300580	
G-AUS-LR	G-AUS-LR	G-AUS-LR	G-AUS-LR	G-AUS-LR LH 1)	G-AUS-LR LH	G-AUS-LR LH	
	„4h“	„6h“	„6e“		„4h“	„6e“	
●	●	●	●	●	●	●	M 82 x 2
●	●	●	●	●	●	●	85 x 1,5
●	●	●	●	●	●	●	85 x 2
●	●	●	●	●	●	●	85 x 3
●	●	●	●	●	●	●	88 x 1,5
●	●	●	●	●	●	●	88 x 2
●	●	●	●	●	●	●	90 x 1,5
●	●	●	●	●	●	●	90 x 2
●	●	●	●	●	●	●	90 x 3
●	●	●	●	●	●	●	92 x 1,5
●	●	●	●	●	●	●	92 x 2
●	●	●	●	●	●	●	95 x 1,5
●	●	●	●	●	●	●	95 x 2
●	●	●	●	●	●	●	95 x 3
●	●	●	●	●	●	●	98 x 1,5
●	●	●	●	●	●	●	98 x 2
●	●	●	●	●	●	●	100 x 1,5
●	●	●	●	●	●	●	100 x 2
●	●	●	●	●	●	●	100 x 3



- Product Finder
- M
- MF
- UNC**
- UNF
- G
- Rp
R, Rc
- NPT, NPTF
- BSW
- Pg
- MJ
UNJC, UNJF
- EG (STI)
SELF-LOCK
- Tr, Tr-F
Rd
- Glatt
Smooth
- GT, TD
- Zubehör
Accessories
- Kalibrieren
Calibration
- Tech. Info

UNC

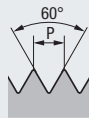

ASME B1.1

Lehrenmaße nach ANSI/ASME B1.2
Gauge dimensions acc. ANSI/ASME B1.2



Toleranz · Tolerance
Beschichtung · Coating

2B 3B 2B 2B

Werkzeug-Ident · Tool ident				L0100100	L0100110	L0120100	L0140100
				G-GR-LD	G-GR-LD	G-GUT-LD	G-AUS-LD
Nr.	Ø d ₁		P Gg/1" (tpi)	Dimens.- Ident			
	inch	inch			„3B“		
Nr. 1	0.0730		64	.5000	●		●
Nr. 2	0.0860		56	.5001	●		●
Nr. 3	0.0990		48	.5002	●		●
Nr. 4	0.1120		40	.5003	●		●
Nr. 5	0.1250		40	.5004	●		●
Nr. 6	0.1380		32	.5005	●		●
Nr. 8	0.1640		32	.5006	●		●
Nr. 10	0.1900		24	.5007	●		●
Nr. 12	0.2160		24	.5008	●		●
1/4	0.2500		20	.5009	●		●
5/16	0.3125		18	.5010	●		●
3/8	0.3750		16	.5011	●	●	●
7/16	0.4375		14	.5012	●	●	●
1/2	0.5000		13	.5013	●	●	●
9/16	0.5625		12	.5014	●	●	●
5/8	0.6250		11	.5015	●	●	●
3/4	0.7500		10	.5016	●	●	●
7/8	0.8750		9	.5017	●	●	●
1"	1.0000		8	.5018	●	●	●
1 1/8	1.1250		7	.5019	●	●	●
1 1/4	1.2500		7	.5020	●	●	●
1 3/8	1.3750		6	.5021	●	●	●
1 1/2	1.5000		6	.5022	●	●	●
1 3/4	1.7500		5	.5023	●	●	●
2"	2.0000		4 1/2	.5024	●	●	●

> Ø 1 1/2 nur als Einzellehdorne erhältlich (G-GUT-LD, G-AUS-LD)
available only as separate plug gauges (G-GUT-LD, G-AUS-LD)

Gewindelehren für UNEF, UN und UNS auf Anfrage
Thread gauges for UNEF, UN and UNS upon request



UNC

ASME B1.1

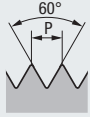

Lehrenmaße nach ANSI/ASME B1.2
Gauge dimensions acc. ANSI/ASME B1.2

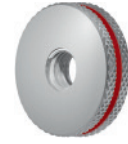
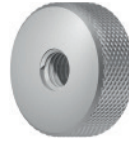
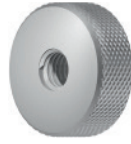

Toleranz · Tolerance
Beschichtung · Coating

2A

3A

2A

3A

Werkzeug-Ident · Tool ident

L0200500

L0200510

L0300500

L0300510

G-GUT-LR

G-GUT-LR

G-AUS-LR

G-AUS-LR

Nr.	ø d ₁		P Gg/1" (tpi)	Dimens.- Ident	L0200500 G-GUT-LR	L0200510 G-GUT-LR „3A“	L0300500 G-AUS-LR	L0300510 G-AUS-LR „3A“
	inch	inch						
Nr. 1	0.0730		64	.5000	●		●	
Nr. 2	0.0860		56	.5001	●		●	
Nr. 3	0.0990		48	.5002	●		●	
Nr. 4	0.1120		40	.5003	●		●	
Nr. 5	0.1250		40	.5004	●		●	
Nr. 6	0.1380		32	.5005	●		●	
Nr. 8	0.1640		32	.5006	●		●	
Nr. 10	0.1900		24	.5007	●		●	
Nr. 12	0.2160		24	.5008	●		●	
1/4	0.2500		20	.5009	●		●	
5/16	0.3125		18	.5010	●		●	
3/8	0.3750		16	.5011	●	●	●	●
7/16	0.4375		14	.5012	●	●	●	●
1/2	0.5000		13	.5013	●	●	●	●
9/16	0.5625		12	.5014	●	●	●	●
5/8	0.6250		11	.5015	●	●	●	●
3/4	0.7500		10	.5016	●	●	●	●
7/8	0.8750		9	.5017	●		●	
1"	1.0000		8	.5018	●		●	
1 1/8	1.1250		7	.5019	●		●	
1 1/4	1.2500		7	.5020	●		●	
1 3/8	1.3750		6	.5021	●		●	
1 1/2	1.5000		6	.5022	●		●	
1 3/4	1.7500		5	.5023	●		●	
2"	2.0000		4 1/2	.5024	●		●	

- Product Finder
- M
- MF
- UNC**
- UNF
- G
- Rp
R, Rc
- NPT, NPTF
- BSW
- Pg
- MJ
UNJC, UNJF
- EG (STI)
SELF-LOCK
- Tr, Tr-F
Rd
- Glatt
Smooth
- GT, TD
- Zubehör
Accessories
- Kalibrierung
Calibration
- Tech. Info



● = Lagerwerkzeug, siehe Preisliste · Stock tool, see price list
○ = Kurzfristig lieferbar, Preis auf Anfrage · Available on short notice, price upon inquiry

- Product Finder
- M
- MF
- UNC
- UNF**
- G
- Rp
R, Rc
- NPT, NPTF
- BSW
- Pg
- MJ
UNJC, UNJF
- EG (STI)
SELF-LOCK
- Tr, Tr-F
Rd
- Glatt
Smooth
- GT, TD
- Zubehör
Accessories
- Kalibrieren
Calibration
- Tech. Info

UNF

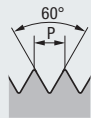

ASME B1.1

Lehrenmaße nach ANSI/ASME B1.2
Gauge dimensions acc. ANSI/ASME B1.2



2B



3B



2B



2B

Toleranz · Tolerance
Beschichtung · Coating

Werkzeug-Ident · Tool ident

L0100100

L0100110

L0120100

L0140100

G-GR-LD

G-GR-LD

G-GUT-LD

G-AUS-LD

Nr.	Ø d ₁		P Gg/1" (tpi)	Dimens.- Ident	L0100100 G-GR-LD	L0100110 G-GR-LD „3B“	L0120100 G-GUT-LD	L0140100 G-AUS-LD
	inch	inch						
Nr. 0	0.0600		80	.5033	●		●	●
Nr. 1	0.0730		72	.5034	●		●	●
Nr. 2	0.0860		64	.5035	●		●	●
Nr. 3	0.0990		56	.5036	●		●	●
Nr. 4	0.1120		48	.5037	●		●	●
Nr. 5	0.1250		44	.5038	●		●	●
Nr. 6	0.1380		40	.5039	●		●	●
Nr. 8	0.1640		36	.5040	●		●	●
Nr. 10	0.1900		32	.5041	●		●	●
Nr. 12	0.2160		28	.5042	●		●	●
1/4	0.2500		28	.5043	●		●	●
5/16	0.3125		24	.5044	●		●	●
3/8	0.3750		24	.5045	●	●	●	●
7/16	0.4375		20	.5046	●	●	●	●
1/2	0.5000		20	.5047	●	●	●	●
9/16	0.5625		18	.5048	●	●	●	●
5/8	0.6250		18	.5049	●	●	●	●
3/4	0.7500		16	.5050	●	●	●	●
7/8	0.8750		14	.5051	●	●	●	●
1"	1.0000		12	.5052	●	●	●	●
1 1/8	1.1250		12	.5053	●	●	●	●
1 1/4	1.2500		12	.5054	●	●	●	●
1 3/8	1.3750		12	.5055	●	●	●	●
1 1/2	1.5000		12	.5056	●	●	●	●

Gewindelehren für UNEF, UN und UNS auf Anfrage
Thread gauges for UNEF, UN and UNS upon request



UNF

ASME B1.1



Lehrenmaße nach ANSI/ASME B1.2
Gauge dimensions acc. ANSI/ASME B1.2

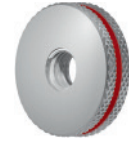
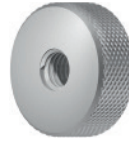
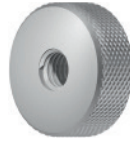

Toleranz · Tolerance
Beschichtung · Coating

2A

3A

2A

3A

Werkzeug-Ident · Tool ident

L0200500

L0200510

L0300500

L0300510

G-GUT-LR

G-GUT-LR

G-AUS-LR

G-AUS-LR

Nr.	Ø d ₁		P Gg/1" (tpi)	Dimens.- Ident				
	inch	inch						
Nr. 0	0.0600		80	.5033	●		●	
Nr. 1	0.0730		72	.5034	●		●	
Nr. 2	0.0860		64	.5035	●		●	
Nr. 3	0.0990		56	.5036	●		●	
Nr. 4	0.1120		48	.5037	●		●	
Nr. 5	0.1250		44	.5038	●		●	
Nr. 6	0.1380		40	.5039	●		●	
Nr. 8	0.1640		36	.5040	●		●	
Nr. 10	0.1900		32	.5041	●		●	
Nr. 12	0.2160		28	.5042	●		●	
1/4	0.2500		28	.5043	●		●	
5/16	0.3125		24	.5044	●		●	
3/8	0.3750		24	.5045	●	●	●	●
7/16	0.4375		20	.5046	●	●	●	●
1/2	0.5000		20	.5047	●	●	●	●
9/16	0.5625		18	.5048	●	●	●	●
5/8	0.6250		18	.5049	●	●	●	●
3/4	0.7500		16	.5050	●	●	●	●
7/8	0.8750		14	.5051	●	●	●	●
1"	1.0000		12	.5052	●	●	●	●
1 1/8	1.1250		12	.5053	●	●	●	●
1 1/4	1.2500		12	.5054	●	●	●	●
1 3/8	1.3750		12	.5055	●	●	●	●
1 1/2	1.5000		12	.5056	●	●	●	●

Product
Finder

M

MF

UNC

UNF

G

Rp
R, Rc

NPT, NPTF

BSW

Pg

MJ
UNJC, UNJF

EG (STI)
SELF-LOCK

Tr, Tr-F
Rd

Glatt
Smooth

GT, TD

Zubehör
Accessories

Kalibrierung
Calibration

Tech. Info



- Product Finder
- M
- MF
- UNC
- UNF
- G**
- Rp
R, Rc
- NPT, NPTF
- BSW
- Pg
- MJ
UNJC, UNJF
- EG (STI)
SELF-LOCK
- Tr, Tr-F
Rd
- Glatt
Smooth
- GT, TD
- Zubehör
Accessories
- Kalibrieren
Calibration
- Tech. Info

G (BSP)

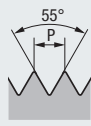

DIN EN ISO 228

Lehrenmaße nach DIN EN ISO 228-2
Gauge dimensions acc. DIN EN ISO 228-2

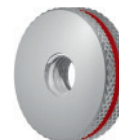
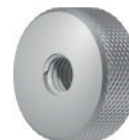

Toleranz · Tolerance
Beschichtung · Coating

A

A

Werkzeug-Ident · Tool ident

L0100100

L0120100

L0140100

L0200500

L0300500

Nenngröße
Nom. size

Dimens.-
Ident

G-GR-LD

G-GUT-LD

G-AUS-LD

G-GUT-LR

G-AUS-LR

Ø d₁

Ø d₁
mm

P

Gg/1" (tpi)

G	Ø d ₁	Ø d ₁ mm	P Gg/1" (tpi)	Dimens.- Ident	G-GR-LD	G-GUT-LD	G-AUS-LD	G-GUT-LR	G-AUS-LR
	1/16	7,72	7,72	28	.4034	●	●	●	●
1/8	9,73	9,73	28	.4035	●	●	●	●	●
1/4	13,16	13,16	19	.4036	●	●	●	●	●
3/8	16,66	16,66	19	.4037	●	●	●	●	●
1/2	20,96	20,96	14	.4038	●	●	●	●	●
5/8	22,91	22,91	14	.4039	●	●	●	●	●
3/4	26,44	26,44	14	.4040	●	●	●	●	●
7/8	30,20	30,20	14	.4041	●	●	●	●	●
1"	33,25	33,25	11	.4042	●	●	●	●	●
1 1/8	37,90	37,90	11	.4043	●	●	●	●	●
1 1/4	41,91	41,91	11	.4044		●	●	●	●
1 3/8	44,32	44,32	11	.4045		●	●	●	●
1 1/2	47,80	47,80	11	.4046		●	●	●	●
1 5/8	52,00	52,00	11	.4047			●	●	●
1 3/4	53,75	53,75	11	.4048		●	●	●	●
2"	59,61	59,61	11	.4050		●	●	●	●

> G 1 1/8 nur als Einzellehrdorne erhältlich (G-GUT-LD, G-AUS-LD)
available only as separate plug gauges (G-GUT-LD, G-AUS-LD)

Gewinde-Lehrringe für Toleranz B auf Anfrage
Thread ring gauges for Tolerance B upon request

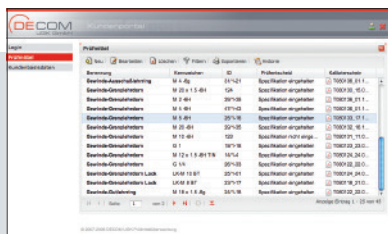

Prüfmittelverwaltungs-Software
KalimeroNet siehe Seite 634

Inspection tool administration software
KalimeroNet, see page 634

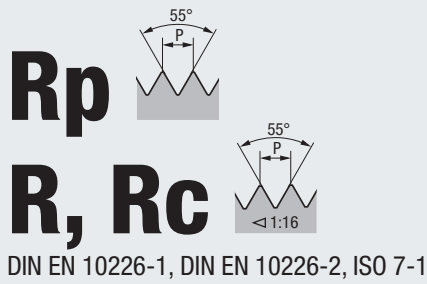

Lehrensysteem nach DIN EN 10226-3, ISO 7-2
Gauge system acc. DIN EN 10226-3, ISO 7-2

Arbeitslehren
Work gauges

Gewinde-Prüflehren
Inspection thread gauges

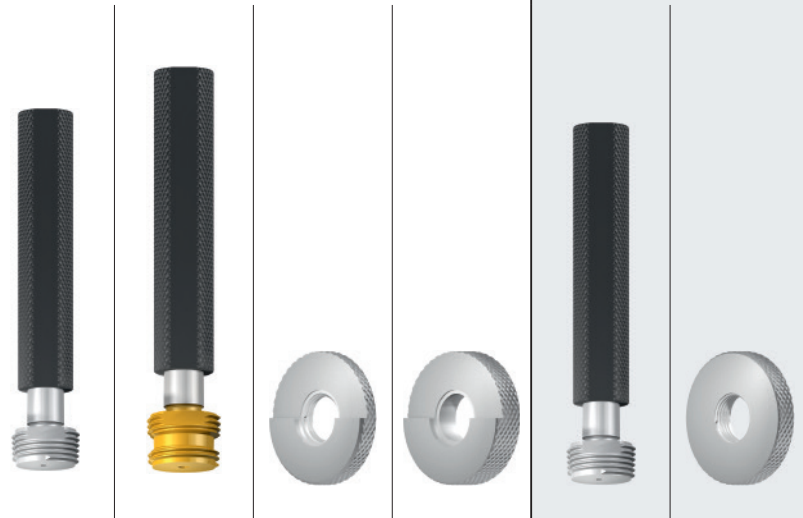

Lehre Nr. · Gauge no.

1	2 ¹⁾	3	4	5	6
---	-----------------	---	---	---	---

Werkzeug-Ident · Tool ident				L1800101	L1815101	L1850501	L1860501	L1830501	L1870101
Nenngröße Nom. size				Keg. G-GR-LD	Keg. G-GR-LD Aussp. TIN	Zyl. G-GR-LR	Keg. G-GR-LR (glatt)	Keg. G-Prüfdorn	Zyl. G-Prüfring
$\varnothing d_1$	$\varnothing d_1$ mm	P Gg/1" (tpi)	Dimens.- Ident						
R	1/16	7,72	28	●	●	●	●	●	●
	1/8	9,73	28	●	●	●	●	●	●
	1/4	13,16	19	●	●	●	●	●	●
	3/8	16,66	19	●	●	●	●	●	●
	1/2	20,96	14	●	●	●	●	●	●
	3/4	26,44	14	●	●	●	●	●	●
	1"	32,25	11	●	●	●	●	●	●
	1 1/4	41,91	11	●	●	●	●	●	●
	1 1/2	47,80	11	●	●	●	●	●	●
	2"	59,61	11	●	●	●	●	●	●
	2 1/2	75,18	11	●	●	●	●	●	●
	3"	87,88	11	●	●	●	●	●	●
	4"	113,03	11	●	●	●	●	●	●

¹⁾ Der Lehrdorn Nr. 2 ist auf Grund der Aussparung starker Beanspruchung ausgesetzt und deshalb TIN-beschichtet
The thread plug gauge no. 2 is exposed to strong wear due to its recess, and is therefore TIN-coated

Das neue Lehrensysteem nach DIN EN 10226-3, ISO 7-2

Ziel der Normung war, ein weltweit akzeptiertes Lehrensysteem für das **kegelige Außengewinde R**, das **zylindrisches Innengewinde Rp** und das **kegelige Innengewinde Rc** nach ISO 7 zu schaffen.

Bisherige Normen, z.B. die deutschen Normen DIN 2999-2 bis -6, die britische Norm BS 21, die französische Norm NF-E 03-165 und die italienische Norm UNI ISO 7-2:1984 sind ungültig.

The new gauge system acc. DIN EN 10226-3, ISO 7-2

The standardization has been undertaken with the aim of providing a worldwide accepted gauge system for the **tapered external thread R**, the **cylindrical internal thread Rp** and the **tapered internal thread Rc** acc. ISO 7.

Previous standards, e.g. the German standards DIN 2999-2 to -6, the British standard BS 21, the French standard NF-E 03-165 and the Italian standard UNI ISO 7-2:1984 do not apply anymore.

- Product Finder
- M
- MF
- UNC
- UNF
- G
- Rp
R, Rc
- NPT, NPTF
- BSW
- Pg
- MJ
UNJC, UNJF
- EG (STI)
SELF-LOCK
- Tr, Tr-F
Rd
- Glatt
Smooth
- GT, TD
- Zubehör
Accessories
- Kalibrierung
Calibration
- Tech. Info



- Product Finder
- M
- MF
- UNC
- UNF
- G
- Rp
R, Rc
- NPT, NPTF**
- BSW
- Pg
- MJ
UNJC, UNJF
- EG (STI)
SELF-LOCK
- Tr, Tr-F
Rd
- Glatt
Smooth
- GT, TD
- Zubehör
Accessories
- Kalibrieren
Calibration
- Tech. Info

NPT

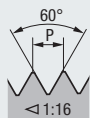

ANSI/ASME B1.20.1

Lehrensystem ähnlich ANSI/ASME B1.20.1
Gauge system sim. ANSI/ASME B1.20.1

Ausführung „3-Step“
“3-Step” Design



Werkzeug-Ident · Tool ident			L0500100	L0600500		
Nenngröße Nom. size		Dimens.- Ident	G-GR-LD (L ₁) NPT	G-GR-LR (L ₁) NPT		
∅ d ₁	P Gg/1" (tpi)					
1/16	27	.5763	●	●		
1/8	27	.5764	●	●		
1/4	18	.5765	●	●		
3/8	18	.5766	●	●		
1/2	14	.5767	●	●		
3/4	14	.5768	●	●		
1"	11 1/2	.5769	●	●		
1 1/4	11 1/2	.5770	●	●		
1 1/2	11 1/2	.5771	●	●		
2"	11 1/2	.5772	●	●		



NPTF

ANSI B1.20.3



Ausführung „3-Step“ “3-Step” Design



Lehrsystem NPTF-1 nach ASME B1.20.5
Gauge system NPTF-1 acc. ASME B1.20.5

Werkzeug-Ident · Tool ident			L0520100	L0500100	L0510100	L0600500
Nenngröße Nom. size	P	Dimens.- Ident	G-GR-LD (L ₁ + L ₃) NPTF	G-GR-LD (L ₁) NPTF	G-GR-LD (L ₃) NPTF	G-GR-LR (L ₁) NPTF
$\varnothing d_1$	Gg/1" (tpi)					
1/16	27	.5782	●			●
1/8	27	.5783	●			●
1/4	18	.5784	●			●
3/8	18	.5785	●			●
1/2	14	.5786	●			●
3/4	14	.5787	●			●
1"	11 1/2	.5788	●			●
1 1/4	11 1/2	.5789		●	●	●
1 1/2	11 1/2	.5790		●	●	●
2"	11 1/2	.5791		●	●	●

> $\varnothing 1"$ nur als Einzellehrdorne erhältlich (G-GR-LD (L₁), G-GR-LD (L₃))
available only as separate plug gauges (G-GR-LD (L₁), G-GR-LD (L₃))

Gewinde-Grenzlehrringe G-GR-LR (L₂) NPTF auf Anfrage
Thread ring gauges go/no-go G-GR-LR (L₂) NPTF upon request

Lehrsystem NPTF-2 nach ASME B1.20.5

für NPTF-Innengewinde

- L₁-Gewinde-Lehrdorn (Ausführung „4-Step“)
- L₃-Gewinde-Lehrdorn (Ausführung „4-Step“)
- Lehrdorn „Crest Check“ („6-Step“),
zur Prüfung der Gewindespitzen am Kerndurchmesser
- Lehrdorn „Root Check“ („6-Step“),
zur Prüfung des Gewindegundes am Außendurchmesser

für NPTF-Außengewinde

- L₁-Gewinde-Lehrring (Ausführung „4-Step“)
- L₂-Gewinde-Lehrring (Ausführung „4-Step“)
- Lehrring „Crest Check“ („6-Step“),
zur Prüfung der Gewindespitzen am Außendurchmesser
- Lehrring „Root Check“ („6-Step“),
zur Prüfung des Gewindegundes am Kerndurchmesser

Gewindegrenzlehren für Lehrsystem NPTF-2 auf Anfrage

Gauge system NPTF-2 acc. ASME B1.20.5

for NPTF internal thread

- L₁ thread plug gauge (“4-step” design)
- L₃ thread plug gauge (“4-step” design)
- Plug gauge “Crest Check” (“6-step”),
for checking the thread crest on the minor diameter
- Plug gauge “Root Check” (“6-step”),
for checking the thread root on the major diameter

for NPTF external thread

- L₁ thread ring gauge (“4-step” design)
- L₂ thread ring gauge (“4-step” design)
- Ring gauge “Crest Check” (“6-step”),
for checking the thread crest on the major diameter
- Ring gauge “Root Check” (“6-step”),
for checking the thread root on the minor diameter

Thread gauges go/no-go for gauge system NPTF-2 upon request

Product
Finder

M

MF

UNC

UNF

G

Rp
R, Rc

NPT, NPTF

BSW

Pg

MJ
UNJC, UNJF

EG (STI)
SELF-LOCK

Tr, Tr-F
Rd

Glatt
Smooth

GT, TD

Zubehör
Accessories

Kalibrierung
Calibration

Tech. Info



- Product Finder
- M
- MF
- UNC
- UNF
- G
- Rp
R, Rc
- NPT, NPTF
- BSW**
- Pg
- MJ
UNJC, UNJF
- EG (STI)
SELF-LOCK
- Tr, Tr-F
Rd
- Glatt
Smooth
- GT, TD
- Zubehör
Accessories
- Kalibrieren
Calibration
- Tech. Info

BSW



BS 84

Lehrenmaße nach BS 919-2
Gauge dimensions acc. BS 919-2

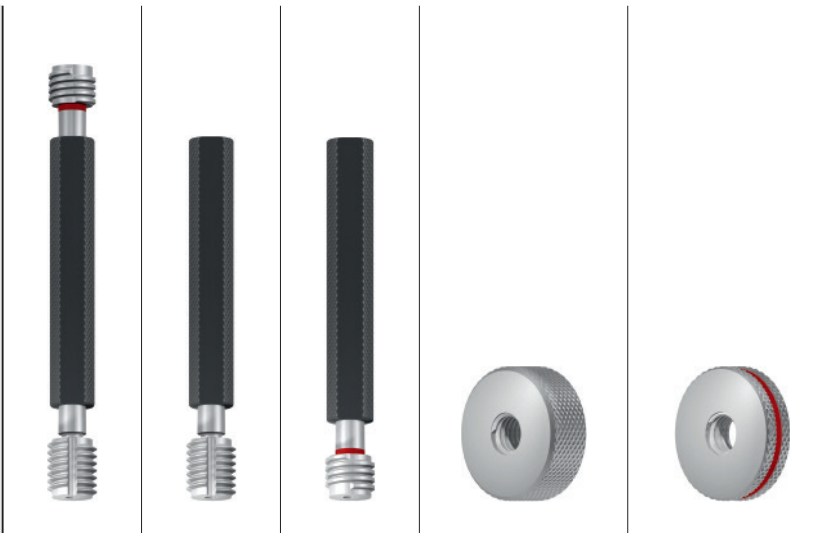

				Toleranz · Tolerance		Beschichtung · Coating			
				med.		med.		med.	
				med.		med. *)		med.	
Werkzeug-Ident · Tool ident				L0100100	L0120100	L0140100	L0200500	L0300500	
				G-GR-LD	G-GUT-LD	G-AUS-LD	G-GUT-LR	G-AUS-LR	
	ø d ₁ inch	ø d ₁ mm	P Gg/1" (tpi)	Dimens.- Ident					
BSW	1/8	3,175	40	.3046	•	•	•	•	•
	3/16	4,763	24	.3048	•	•	•	•	•
	1/4	6,350	20	.3050	•	•	•	•	•
	5/16	7,938	18	.3051	•	•	•	•	•
	3/8	9,525	16	.3052	•	•	•	•	•
	7/16	11,113	14	.3053	•	•	•	•	•
	1/2	12,700	12	.3054	•	•	•	•	•
	9/16	14,288	12	.3055	•	•	•	•	•
	5/8	15,875	11	.3056	•	•	•	•	•
	3/4	19,050	10	.3058	•	•	•	•	•
	7/8	22,225	9	.3060	•	•	•	•	•
	1"	25,400	8	.3062	•	•	•	•	•
	1 1/8	28,575	7	.3063	•	•	•	•	•
	1 1/4	31,750	7	.3064	•	•	•	•	•
	1 3/8	34,925	6	.3065					
	1 1/2	38,100	6	.3066	•	•	•	•	•
	1 3/4	44,450	5	.3068	•	•	•	•	•
	2"	50,800	4 1/2	.3070		•	•	•	•

*) ≤ 3/4 Tol. „medium class, before plating“

Gewindelehren für BSF und andere Whitworth-Gewinde auf Anfrage
Thread gauges for BSF and other Whitworth threads upon request

> ø 1 1/2 nur als Einzellehrdorne erhältlich (G-GUT-LD, G-AUS-LD)
available only as separate plug gauges (G-GUT-LD, G-AUS-LD)



Pg
DIN 40430

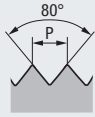

Lehrenmaße nach DIN 40431
Gauge dimensions acc. DIN 40431



Toleranz · Tolerance
Beschichtung · Coating

Werkzeug-Ident · Tool ident				L0180100	L0120100	L0190100	L0200500	L0320500
Nenngröße Nom. size				G-GR-LD	G-GUT-LD	G-AUS-LD ¹⁾	G-GUT-LR	G-AUS-LR ²⁾
Ø d ₁	Ø d ₁ mm	P Gg/1" (tpi)	Dimens.- Ident					
Pg 7	12,5	20	.4153	●			●	●
9	15,2	18	.4154	●			●	●
11	18,6	18	.4155	●			●	●
13,5	20,4	18	.4156	●			●	●
16	22,5	18	.4157	●			●	●
21	28,3	16	.4158	●			●	●
29	37	16	.4159	●			●	●
36	47	16	.4160		●	●	●	●
42	54	16	.4161		●	●	●	●
48	59,3	16	.4162		●	●	●	●

≥ Pg 36 nur als Einzellehrdorne erhältlich (G-GUT-LD, G-AUS-LD)
available only as separate plug gauges (G-GUT-LD, G-AUS-LD)

¹⁾ Der Ausschusslehndorn prüft nur den Innengewinde-Kerndurchmesser und ist deshalb ein glatter Lehndorn
The no-go plug gauge checks only the minor diameter of the internal thread, and is therefore a smooth plug gauge

²⁾ Der Ausschusslehring prüft nur den Außengewinde-Außendurchmesser und ist deshalb ein glatter Lehring
The no-go ring gauge checks only the major diameter of the external thread, and is therefore a smooth ring gauge

- Product Finder
- M
- MF
- UNC
- UNF
- G
- Rp
R, Rc
- NPT, NPTF
- BSW
- Pg**
- MJ
UNJC, UNJF
- EG (STI)
SELF-LOCK
- Tr, Tr-F
Rd
- Glatt
Smooth
- GT, TD
- Zubehör
Accessories
- Kalibrierung
Calibration
- Tech. Info



- Product Finder
- M
- MF
- UNC
- UNF
- G
- Rp
R, Rc
- NPT, NPTF
- BSW
- Pg
- MJ
UNJC, UNJF
- EG (STI)
SELF-LOCK
- Tr, Tr-F
Rd
- Glatt
Smooth
- GT, TD
- Zubehör
Accessories
- Kalibrieren
Calibration
- Tech. Info

MJ



DIN ISO 5855



Lehrenmaße nach DIN ISO 1502
Gauge dimensions acc. DIN ISO 1502

Toleranz · Tolerance
Beschichtung · Coating

4H

Werkzeug-Ident · Tool ident

L0100110

G-GR-LD

	ø d ₁ mm		P mm	Dimens.- Ident	
M	3	x	0,5	.1229	●
	4	x	0,7	.1231	●
	5	x	0,8	.1232	●
	6	x	1	.1233	●
	8	x	1	.1235	●
	8	x	1,25	.2026	●
	10	x	1,25	.1236	●
	10	x	1,5	.2308	●

Gewindelehringe MJ auf Anfrage
Thread ring gauges MJ upon request

UNJC



ASME B1.15



Lehrenmaße nach ANSI/ASME B1.2
Gauge dimensions acc. ANSI/ASME B1.2

Toleranz · Tolerance
Beschichtung · Coating

3B

Werkzeug-Ident · Tool ident

L0100110

G-GR-LD

	ø d ₁ inch		P Gg/1" (tpi)	Dimens.- Ident	
Nr. 4	0.1120		40	.5479	●
Nr. 6	0.1380		32	.5481	●
Nr. 8	0.1640		32	.5482	●
Nr. 10	0.1900		24	.5483	●
1/4	0.2500		20	.5485	●
5/16	0.3125		18	.5486	●
3/8	0.3750		16	.5487	●

Gewinde-Lehringe für UNJC auf Anfrage
Thread ring gauges for UNJC upon request

UNJF



ASME B1.15



Lehrenmaße nach ANSI/ASME B1.2
Gauge dimensions acc. ANSI/ASME B1.2

Toleranz · Tolerance
Beschichtung · Coating

3B

Werkzeug-Ident · Tool ident

L0100110

G-GR-LD

	ø d ₁ inch		P Gg/1" (tpi)	Dimens.- Ident	
Nr. 4	0.1120		48	.5505	●
Nr. 6	0.1380		40	.5507	●
Nr. 8	0.1640		36	.5508	●
Nr. 10	0.1900		32	.5509	●
1/4	0.2500		28	.5511	●
5/16	0.3125		24	.5512	●
3/8	0.3750		24	.5513	●

Gewinde-Lehringe für UNJF auf Anfrage
Thread ring gauges for UNJF upon request

EG M (STI)

DIN 8140-2



Lehrenmaße nach DIN ISO 1502
Gauge dimensions acc. DIN ISO 1502

Toleranz · Tolerance
Beschichtung · Coating

6H mod.

Werkzeug-Ident · Tool ident

L0100100

G-GR-LD

Nenngröße Nom. size	Dimens.- Ident		●
	Ø d ₁	P mm	
EG M	2,5	0,45	●
	3	0,5	●
	3,5	0,6	●
	4	0,7	●
	5	0,8	●
	6	1	●
	8	1,25	●
	10	1,5	●
	12	1,75	●
	14	2	●
	16	2	●
	18	2,5	●
	20	2,5	●

EG-Gewindelehren für Metrisches ISO-Feingewinde, UNC und UNF auf Anfrage
STI (EG) thread gauges for ISO Metric fine thread, UNC and UNF thread upon request

- Product Finder
- M
- MF
- UNC
- UNF
- G
- Rp
R, Rc
- NPT, NPTF
- BSW
- Pg
- MJ
UNJC, UNJF
- EG (STI)**
SELF-LOCK
- Tr, Tr-F
Rd
- Glatt
Smooth
- GT, TD
- Zubehör
Accessories
- Kalibrierung
Calibration
- Tech. Info

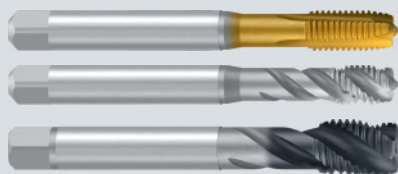

Gewindebohrer für Metrisches
EG-Gewinde siehe Seite 216 - 219

Taps for Metric STI thread,
see page 216 - 219



- Product Finder
- M
- MF
- UNC
- UNF
- G
- Rp
R, Rc
- NPT, NPTF
- BSW
- Pg
- MJ
UNJC, UNJF
- EG (STI)
SELF-LOCK
- Tr, Tr-F
Rd
- Glatt
Smooth
- GT, TD
- Zubehör
Accessories
- Kalibrieren
Calibration
- Tech. Info

LK-M

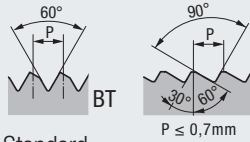

EMUGE-Norm · EMUGE Standard



Lehrenmaße nach EMUGE-Norm
Gauge dimensions acc. EMUGE standard

Werkzeug-Ident · Tool ident			L0100100			
			G-GR-LD			
	Ø d ₁ mm	P mm	Dimens.- Ident			
LK-M	3	0,5	.1046	●		
	4	0,7	.1048	●		
	5	0,8	.1050	●		
	6	1	.1052	●		
	8	1,25	.1054	●		
	10	1,5	.1056	●		
	12	1,75	.1058	●		
	14	2	.1059	●		
	16	2	.1060	●		
	20	2,5	.1062	●		
	24	3	.1064	●		

Die Lehrung des EMUGE SELF-LOCK-Gewindes

Wir empfehlen unser zweiteiliges Lehrensystem, das der gängigen Praxis der Gut- und Ausschuss-Lehre entspricht und vollkommen für die Gewindeprüfung ausreicht, wenn sichergestellt ist, dass das LK-Gewinde mit unseren profilgetreuen Gewindebohrern hergestellt wird. Es gibt keine allgemein gültige Norm (z.B. DIN-Norm) über das EMUGE SELF-LOCK-Gewinde. Andere Werkzeughersteller könnten daher mit anderen Gewinde-Grenzmaßen arbeiten. Daher empfehlen wir, EMUGE SELF-LOCK-Gewinde ausschließlich mit EMUGE SELF-LOCK-Gewindelehren zu prüfen.

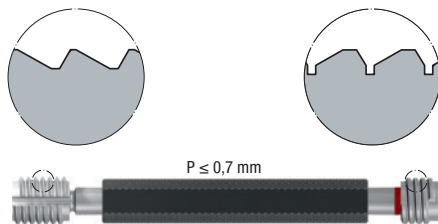

Die Lehrung des Sägezahn-Profiles beruht auf dem gleichen Prinzip, jedoch ist bei Gut- und Ausschusslehren auf die richtige Einschraubseite zu achten.

The gauging of the EMUGE SELF-LOCK thread

We recommend using our two-piece gauge system which corresponds to the usual combination of go and no-go gauge and is perfectly sufficient for the gauging of the thread, provided that the LK threads were produced with our true-to-profile EMUGE taps. There is no generally applicable standard (e.g. DIN standard) for the EMUGE SELF-LOCK thread, so other manufacturers may use different limit sizes for their threads. For this reason, we recommend gauging EMUGE SELF-LOCK threads exclusively with EMUGE SELF-LOCK gauges.

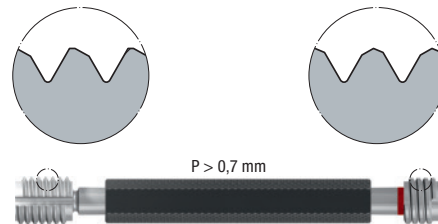

The gauging of the saw-tooth profile works on the same principle, with the only difference that both the go and the no-go plug gauge have to be used in the correct direction.

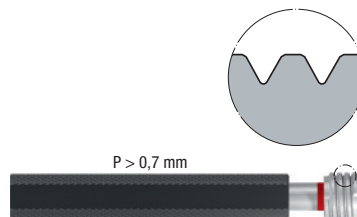

Werden Strehler oder Gewindefräser eingesetzt, empfehlen wir die zusätzliche Verwendung der EMUGE HRPG-Lehre. Diese prüft den unteren Rampenpunkt bzw. eventuelle Rampenwinkelfehler.

If chasers or thread milling cutters are used, we recommend using an additional EMUGE HRPG gauge. This gauge serves to check the lower ramp point or possible ramp angle errors.



DIN 103

Lehrenmaße nach DIN 103-9
Gauge dimensions acc. DIN 103-9

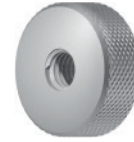

Toleranz · Tolerance
Beschichtung · Coating

7H

7H

7H

7e

7e

Werkzeug-Ident · Tool ident

L0100100

L0120100

L0140100

L0200500

L0300500

G-GR-LD

G-GUT-LD

G-AUS-LD

G-GUT-LR

G-AUS-LR

Tr	ø d ₁ mm	x	P mm	Dimens.- Ident	Werkzeug-Ident · Tool ident				
					G-GR-LD	G-GUT-LD	G-AUS-LD	G-GUT-LR	G-AUS-LR
8	x	1,5	.7040	○	○	○	○	○	
9	x	2	.7042	○	○	○	○	○	
10	x	2	.7043	○	○	○	○	○	
10	x	3	.7044	○	○	○	○	○	
11	x	3	.7045	○	○	○	○	○	
12	x	3	.7046	○	○	○	○	○	
14	x	3	.7047	○	○	○	○	○	
14	x	4	.7048	○	○	○	○	○	
16	x	4	.7051	○	○	○	○	○	
18	x	4	.7052	○	○	○	○	○	
20	x	4	.7053	○	○	○	○	○	
22	x	5	.7054	○	○	○	○	○	
24	x	5	.7055	○	○	○	○	○	
26	x	5	.7057	○	○	○	○	○	
28	x	5	.7058	○	○	○	○	○	
30	x	6	.7059	○	○	○	○	○	
32	x	6	.7060	○	○	○	○	○	
34	x	6	.7061	○	○	○	○	○	
36	x	6	.7062	○	○	○	○	○	
38	x	7	.7063	○	○	○	○	○	
40	x	7	.7064	○	○	○	○	○	
42	x	7	.7065	○	○	○	○	○	
44	x	7	.7066	○	○	○	○	○	
46	x	8	.7067	○	○	○	○	○	
48	x	8	.7068	○	○	○	○	○	
50	x	8	.7069	○	○	○	○	○	
52	x	8	.7070	○	○	○	○	○	

> ø 40 nur als Einzellehrdorne erhältlich (G-GUT-LD, G-AUS-LD)
available only as separate plug gauges (G-GUT-LD, G-AUS-LD)

- Product Finder
- M
- MF
- UNC
- UNF
- G
- Rp
R, Rc
- NPT, NPTF
- BSW
- Pg
- MJ
UNJC, UNJF
- EG (STI)
SELF-LOCK
- Tr, Tr-F
Rd
- Glatt
Smooth
- GT, TD
- Zubehör
Accessories
- Kalibrierung
Calibration
- Tech. Info



- Product Finder
- M
- MF
- UNC
- UNF
- G
- Rp
R, Rc
- NPT, NPTF
- BSW
- Pg
- MJ
UNJC, UNJF
- EG (STI)
SELF-LOCK
- Tr, Tr-F
Rd
- Glatt
Smooth
- GT, TD
- Zubehör
Accessories
- Kalibrieren
Calibration
- Tech. Info

Tr-F

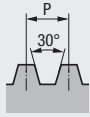

DIN 103

Lehrenmaße nach DIN 103-9
Gauge dimensions acc. DIN 103-9

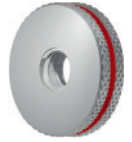
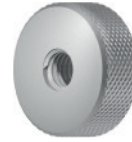

Toleranz · Tolerance
Beschichtung · Coating

7H

7H

7H

7e

7e

Werkzeug-Ident · Tool ident

L0100100

L0120100

L0140100

L0200500

L0300500

G-GR-LD

G-GUT-LD

G-AUS-LD

G-GUT-LR

G-AUS-LR

Tr	Ø d ₁ mm	x	P mm	Dimens.- Ident					
					G-GR-LD	G-GUT-LD	G-AUS-LD	G-GUT-LR	G-AUS-LR
Tr	9	x	1,5	.7111	○	○	○	○	○
	10	x	1,5	.7112	○	○	○	○	○
	11	x	2	.7128	○	○	○	○	○
	12	x	2	.7129	○	○	○	○	○
	14	x	2	.7130	○	○	○	○	○
	16	x	2	.7132	○	○	○	○	○
	18	x	2	.7133	○	○	○	○	○
	20	x	2	.7134	○	○	○	○	○
	22	x	3	.7156	○	○	○	○	○
	24	x	3	.7157	○	○	○	○	○
	26	x	3	.7159	○	○	○	○	○
	28	x	3	.7160	○	○	○	○	○
	30	x	3	.7161	○	○	○	○	○

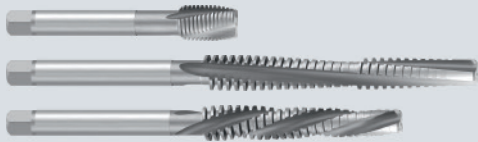

Gewindebohrer für Trapez-Gewinde
siehe Seite 232 - 236

Taps for trapezoidal threads,
see page 232 - 236

Rd

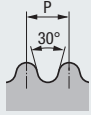

DIN 405

Lehrenmaße nach DIN 405-3
Gauge dimensions acc. DIN 405-3

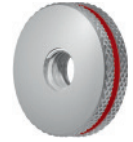
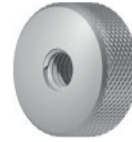

Toleranz · Tolerance
Beschichtung · Coating

7H

7H

7H

7h

7h

Werkzeug-Ident · Tool ident

L0100200

L0120200

L0140200

L0200600

L0300600

G-GR-LD

G-GUT-LD

G-AUS-LD

G-GUT-LR

G-AUS-LR

¹⁾

¹⁾

Rd	ø d ₁ mm	x	P Gg/1" (tpi)	Dimens.- Ident					
					G-GR-LD	G-GUT-LD	G-AUS-LD	G-GUT-LR	G-AUS-LR
	8	x	10	.7287	●	●	●	●	●
	9	x	10	.7288	●	●	●	●	●
	10	x	10	.7289	●	●	●	●	●
	11	x	10	.7290	●	●	●	●	●
	12	x	10	.7291	●	●	●	●	●
	14	x	8	.7293	●	●	●	●	●
	16	x	8	.7294	●	●	●	●	●
	18	x	8	.7295	●	●	●	●	●
	20	x	8	.7296	●	●	●	●	●

¹⁾ Toleranz 7e auf Anfrage
Tolerance 7e upon request

Product
Finder

M

MF

UNC

UNF

G

Rp

R, Rc

NPT, NPTF

BSW

Pg

MJ

UNJC, UNJF

EG (STI)

SELF-LOCK

Tr, Tr-F

Rd

Glatt

Smooth

GT, TD

Zubehör

Accessories

Kalibrierung

Calibration

Tech. Info



- Product Finder
- M
- MF
- UNC
- UNF
- G
- Rp
R, Rc
- NPT, NPTF
- BSW
- Pg
- MJ
UNJC, UNJF
- EG (STI)
SELF-LOCK
- Tr, Tr-F
Rd
- Glatt
Smooth
- GT, TD
- Zubehör
Accessories
- Kalibrieren
Calibration
- Tech. Info

Lehrenmaße nach DIN EN ISO 1938-1
Gauge dimensions acc. DIN EN ISO 1938-1



		Toleranz · Tolerance		
		H7	H7	H7
Werkzeug-Ident · Tool ident		L14000H7	L14200H7	L14400H7
Neendurchmesser Nominal diameter	Dimens.- Ident	GR-LD DIN 2245 Form Z	GUT-LD DIN 2246 Form ZG	AUS-LD DIN 2247 Form ZA
3	.0030	•		
3,5	.0035	•		
4	.0040	•		
4,5	.0045	•		
5	.0050	•		
5,5	.0055	•		
6	.0060	•		
7	.0070	•		
8	.0080	•		
9	.0090	•		
10	.0100	•		
11	.0110	•		
12	.0120	•		
13	.0130	•		
14	.0140	•		
15	.0150	•		
16	.0160	•		
17	.0170	•		
18	.0180	•		
19	.0190	•		
20	.0200	•		
21	.0210	•		
22	.0220	•		
23	.0230	•		
24	.0240	•		
25	.0250	•		
26	.0260	•		
27	.0270	•		
28	.0280	•		
30	.0300	•		
32	.0320	•		
33	.0330	•		
34	.0340	•		
35	.0350	•		
36	.0360	•		
37	.0370	•		
40	.0400	•		
44	.0440	•		
45	.0450	•		
46	.0460	•		
47	.0470	•		
48	.0480	•		
50	.0500	•		
52	.0520	•		
55	.0550	•		
58	.0580	•		
60	.0600	•		
62	.0620	•		
65	.0650	•		
68	.0680	•		
70	.0700		•	•
72	.0720		•	•
75	.0750		•	•
78	.0780		•	•
80	.0800		•	•

> ø 65 nur als Einzellehndorne erhältlich (GUT-LD, AUS-LD)
available only as separate plug gauges (GUT-LD, AUS-LD)

Weitere Toleranzen nach DIN EN ISO 286-2 auf Anfrage herstellbar. Further tolerances according to DIN ISO 286-2 can be produced upon request.

M



Für geschnittene Gewinde
For cut threads

DIN 13

Lehrenmaße nach DIN ISO 1502
Gauge dimensions acc. DIN ISO 1502



Toleranz · Tolerance

6H

Werkzeug-Ident · Tool ident

L0160100

Metrische Gewinde Metric threads	Innengewinde-Kerndurchmesser Minor dia. of the internal thread		Dimens.- Ident	Glatt-GR-LD
	min.	max.		
M 3	2,459	2,599	.0030	●
3,5	2,850	3,010	.0035	
4	3,242	3,422	.0040	●
4,5	3,688	3,878	.0045	
5	4,134	4,334	.0050	●
6	4,917	5,153	.0060	●
7	5,917	6,153	.0070	●
8	6,647	6,912	.0080	●
9	7,647	7,912	.0090	
10	8,376	8,676	.0100	●
11	9,376	9,676	.0111	
12	10,106	10,441	.0112	●
14	11,835	12,210	.0114	
16	13,835	14,210	.0116	●
18	15,294	15,744	.0118	
20	17,294	17,744	.0120	

M



Für geformte Gewinde
For cold-formed threads

DIN 13

Lehrenmaße nach DIN ISO 1502
Gauge dimensions acc. DIN ISO 1502

Gemäß DIN 13-50 beträgt beim geformten Innengewinde die **Toleranz** für den Flankendurchmesser 6H, für den **Innengewinde-Kerndurchmesser 7H**.

According to DIN 13-50, in a cold-formed thread the **tolerance** for the pitch diameter is 6H, for the **minor diameter of the internal thread** it is 7H.

Toleranz · Tolerance

7H

Werkzeug-Ident · Tool ident

L0160105

Metrische Gewinde Metric threads	Innengewinde-Kerndurchmesser Minor dia. of the internal thread		Dimens.- Ident	Glatt-GR-LD
	min.	max.		
M 3	2,459	2,639	.0030	●
3,5	2,850	3,050	.0035	
4	3,242	3,466	.0040	●
5	4,134	4,384	.0050	●
6	4,917	5,217	.0060	●
7	5,917	6,217	.0070	●
8	6,647	6,982	.0080	●
10	8,376	8,751	.0100	●
12	10,106	10,531	.0112	●
14	11,835	12,310	.0114	
16	13,835	14,310	.0116	●

Weitere Ausführungen auf Anfrage
Further designs upon request

Product
Finder

M

MF

UNC

UNF

G

Rp
R, Rc

NPT, NPTF

BSW

Pg

MJ
UNJC, UNJF

EG (STI)
SELF-LOCK

Tr, Tr-F
Rd

Glatt
Smooth

GT, TD

Zubehör
Accessories

Kalibrierung
Calibration

Tech. Info



- Product Finder
- M
- MF
- UNC
- UNF
- G
- Rp
R, Rc
- NPT, NPTF
- BSW
- Pg
- MJ
UNJC, UNJF
- EG (STI)
SELF-LOCK
- Tr, Tr-F
Rd
- Glatt
Smooth
- GT, TD
- Zubehör
Accessories
- Kalibrieren
Calibration
- Tech. Info

M



DIN 13

Lehrenmaße nach DIN ISO 1502
Gauge dimensions acc. DIN ISO 1502

Analog Analogue

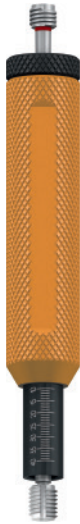

Digital Digital



Toleranz · Tolerance

6H

6H

6H

6H

Max. Gewindetiefe
Max. thread depth

4 x D

2,5 x D

2,5 x D

2,5 x D

Werkzeug-Ident · Tool ident

L1010100

L1040100

L1020200

L1050200

	Ø d ₁ mm	P mm	Dimens.- Ident	Werkzeug-Ident · Tool ident			
				GT-GR-LD „analog“	TD-Bit-GUT „analog“	GT-GR-LD „digital IW“	TD-Bit-GUT „digital IW“
M	2	0,4	.0020	●			
	3	0,5	.0030	●			
	4	0,7	.0040	●			
	5	0,8	.0050	●	●	●	●
	6	1	.0060	●	●	●	●
	8	1,25	.0080	●	●	●	●
	10	1,5	.0100	●	●	●	●
	12	1,75	.0112	●	●	●	●
	14	2	.0114	●	●	●	●
	16	2	.0116	●		●	
	18	2,5	.0118	●		●	
	20	2,5	.0120	●			
22	2,5	.0122	●				
24	3	.0124	●				

1) EG-Konformitätserklärung siehe Seite 646
EC Declaration of Conformity, see page 646

MF



Metrisches ISO-Feingewinde DIN 13
im gleichen Gewindeabmessungs-Bereich auf Anfrage erhältlich

ISO Metric fine threads DIN 13
with identical thread dimensions are available on request



Gefühlsratsche für Gewindetiefen-Lehndorne GT-GR-LD „analog“ und „digital IW“ auf Anfrage verfügbar
Torque limiter for thread depth plug gauges GT-GR-LD „analogue“ and „digital IW“ available on request

Zubehör Accessories



Abziehhülsen zum Austausch des Gut-Lehrenkörpers für alle Ausführungen
Pulling sleeves for exchange of the go gauge body for all versions

» 628



USB-Funkempfänger i-Stick und Software für Ausführungen „digital IW“
USB Wireless receiver i-Stick and software for versions „digital IW“

» 629



Hakenschlüssel zum Anziehen der Kontermutter bei GT-GR-LD
Hook spanner for tightening the counter nut of GT-GR-LD

» 629

UNC

ASME B1.1

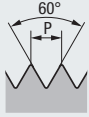

Analog
Analogue

Digital
Digital

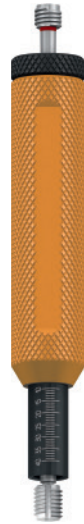

Lehrenmaße nach ANSI/ASME B1.2
Gauge dimensions acc. ANSI/ASME B1.2

Toleranz · Tolerance

2B

2B

2B

2B

Max. Gewindetiefe
Max. thread depth

4 x D

2,5 x D

2,5 x D

2,5 x D

Werkzeug-Ident · Tool ident

L1010100

L1040100

L1020200

L1050200

ø d ₁ inch	inch	P Gg/1" (tpi)	Dimens.- Ident	GT-GR-LD „analog“	TD-Bit-GUT „analog“	GT-GR-LD „digital IW“	TD-Bit-GUT „digital IW“
Nr. 1	0.0730	64	.5000	●			
Nr. 2	0.0860	56	.5001	●			
Nr. 3	0.0990	48	.5002	●			
Nr. 4	0.1120	40	.5003	●			
Nr. 5	0.1250	40	.5004	●	●	●	
Nr. 6	0.1380	32	.5005	●	●	●	●
Nr. 8	0.1640	32	.5006	●	●	●	●
Nr. 10	0.1900	24	.5007	●	●	●	●
Nr. 12	0.2160	24	.5008	●	●	●	●
1/4	0.2500	20	.5009	●	●	●	●
5/16	0.3125	18	.5010	●	●	●	●
3/8	0.3750	16	.5011	●	●	●	●
7/16	0.4375	14	.5012	●	●	●	●
1/2	0.5000	13	.5013	●	●	●	●
9/16	0.5625	12	.5014	●	●	●	●
5/8	0.6250	11	.5015	●	●	●	●
3/4	0.7500	10	.5016	●	●	●	●
7/8	0.8750	9	.5017	●	●	●	●

1) EG-Konformitätserklärung siehe Seite 646
EC Declaration of Conformity, see page 646



Gefühlsratsche für Gewindetiefen-Lehrdorne GT-GR-LD „analog“ und „digital IW“ auf Anfrage verfügbar
Torque limiter for thread depth plug gauges GT-GR-LD „analogue“ and „digital IW“ available on request

Zubehör
Accessories

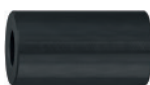

Abziehhülsen zum Austausch des Gut-Lehrenkörpers für alle Ausführungen
Pulling sleeves for exchange of the go gauge body for all versions

» 628



USB-Funkempfänger i-Stick und Software für Ausführungen „digital IW“
USB Wireless receiver i-Stick and software for versions „digital IW“

» 629



Hakenschlüssel zum Anziehen der Kontermutter bei GT-GR-LD
Hook spanner for tightening the counter nut of GT-GR-LD

» 629

- Product Finder
- M
- MF
- UNC**
- UNF
- G
- Rp
R, Rc
- NPT, NPTF
- BSW
- Pg
- MJ
UNJC, UNJF
- EG (STI)
SELF-LOCK
- Tr, Tr-F
Rd
- Glatt
Smooth
- GT, TD**
- Zubehör
Accessories
- Kalibrierung
Calibration
- Tech. Info



- Product Finder
- M
- MF
- UNC
- UNF**
- G
- Rp
R, Rc
- NPT, NPTF
- BSW
- Pg
- MJ
UNJC, UNJF
- EG (STI)
SELF-LOCK
- Tr, Tr-F
Rd
- Glatt
Smooth
- GT, TD
- Zubehör
Accessories
- Kalibrieren
Calibration
- Tech. Info

UNF

ASME B1.1

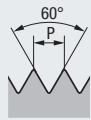

Lehrenmaße nach ANSI/ASME B1.2
Gauge dimensions acc. ANSI/ASME B1.2

Analog
Analogue

Digital
Digital

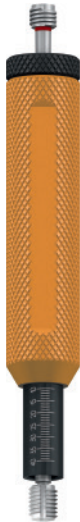

				Toleranz · Tolerance			
				2B	2B	2B	2B
Max. Gewindetiefe Max. thread depth				4 x D	2,5 x D	2,5 x D	2,5 x D
Werkzeug-Ident · Tool ident				L1010100	L1040100	L1020200	L1050200
				GT-GR-LD „analog“	TD-Bit-GUT „analog“	GT-GR-LD „digital IW“	TD-Bit-GUT „digital IW“
Nr.	Ø d ₁		P	Dimens.- Ident			
	inch	Gg/1" (tpi)					
Nr. 0	0.0600	80	.5033	●			
Nr. 1	0.0730	72	.5034	●			
Nr. 2	0.0860	64	.5035	●			
Nr. 3	0.0990	56	.5036	●			
Nr. 4	0.1120	48	.5037	●			
Nr. 5	0.1250	44	.5038	●	●		
Nr. 6	0.1380	40	.5039	●	●	●	●
Nr. 8	0.1640	36	.5040	●	●	●	●
Nr. 10	0.1900	32	.5041	●	●	●	●
Nr. 12	0.2160	28	.5042	●	●	●	●
1/4	0.2500	28	.5043	●	●	●	●
5/16	0.3125	24	.5044	●	●	●	●
3/8	0.3750	24	.5045	●	●	●	●
7/16	0.4375	20	.5046	●	●	●	●
1/2	0.5000	20	.5047	●	●	●	●
9/16	0.5625	18	.5048	●		●	
5/8	0.6250	18	.5049	●		●	
3/4	0.7500	16	.5050	●			
7/8	0.8750	14	.5051	●			

1) EG-Konformitätserklärung siehe Seite 646
EC Declaration of Conformity, see page 646



Gefühlsratsche für Gewindetiefen-Lehrrdorne GT-GR-LD „analog“ und „digital IW“ auf Anfrage verfügbar
Torque limiter for thread depth plug gauges GT-GR-LD „analogue“ and „digital IW“ available on request

Zubehör Accessories

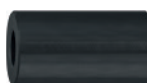

Abziehhülsen zum Austausch des Gut-Lehrenkörpers für alle Ausführungen
Pulling sleeves for exchange of the go gauge body for all versions

» 628



USB-Funkempfänger i-Stick und Software für Ausführungen „digital IW“
USB Wireless receiver i-Stick and software for versions „digital IW“

» 629



Hakenschlüssel zum Anziehen der Kontermutter bei GT-GR-LD
Hook spanner for tightening the counter nut of GT-GR-LD

» 629

G (BSP)

DIN EN ISO 228

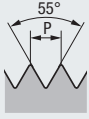

Analog
Analogue

Digital
Digital

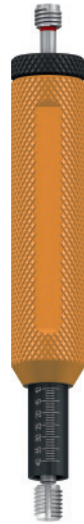

Lehrenmaße nach DIN EN ISO 228-2
Gauge dimensions acc. DIN EN ISO 228-1

Toleranz · Tolerance

Max. Gewindetiefe
Max. thread depth

4 x D

2,5 x D

2,5 x D

2,5 x D

Werkzeug-Ident · Tool ident

L1010100

L1040100

L1020200

L1050200

GT-GR-LD
„analog“

TD-Bit-GUT
„analog“

GT-GR-LD
„digital IW“

TD-Bit-GUT
„digital IW“

Nenngröße Nom. size	Ø d ₁ mm	P Gg/1" (tpi)	Dimens.- Ident				
				GT-GR-LD „analog“	TD-Bit-GUT „analog“	GT-GR-LD „digital IW“	TD-Bit-GUT „digital IW“
G 1/16	7,72	28	.4034	●	●	●	●
1/8	9,73	28	.4035	●	●	●	●
1/4	13,16	19	.4036	●	●	●	●
3/8	16,66	19	.4037	●	●	●	●
1/2	20,96	14	.4038	●	●	●	●
5/8	22,91	14	.4039	●	●	●	●

1) EG-Konformitätserklärung siehe Seite 646
EG Declaration of Conformity, see page 646



Gefühlsratsche für Gewindetiefen-Lehrdorne GT-GR-LD „analog“ und „digital IW“ auf Anfrage verfügbar
Torque limiter for thread depth plug gauges GT-GR-LD „analogue“ and „digital IW“ available on request

Zubehör
Accessories

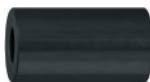

Abziehhülsen zum Austausch des Gut-Lehrenkörpers für alle Ausführungen
Pulling sleeves for exchange of the go gauge body for all versions

» 628



USB-Funkempfänger i-Stick und Software für Ausführungen „digital IW“
USB Wireless receiver i-Stick and software for versions „digital IW“

» 629



Hakenschlüssel zum Anziehen der Kontermutter bei GT-GR-LD
Hook spanner for tightening the counter nut of GT-GR-LD

» 629

● = Lagerwerkzeug, siehe Preisliste · Stock tool, see price list
○ = Kurzfristig lieferbar, Preis auf Anfrage · Available on short notice, price upon inquiry

Product Finder

- M
- MF
- UNC
- UNF
- G**
- Rp
R, Rc
- NPT, NPTF
- BSW
- Pg
- MJ
UNJC, UNJF
- EG (STI)
SELF-LOCK
- Tr, Tr-F
Rd
- Glatt
Smooth
- GT, TD**
- Zubehör
Accessories
- Kalibrierung
Calibration
- Tech. Info

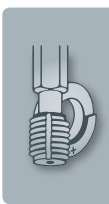

- Product Finder
- M
- MF
- UNC
- UNF
- G
- Rp
R, Rc
- NPT, NPTF
- BSW
- Pg
- MJ
UNJC, UNJF
- EG (STI)
SELF-LOCK
- Tr, Tr-F
Rd
- Glatt
Smooth
- GT, TD
- Zubehör
Accessories
- Kalibrieren
Calibration
- Tech. Info

Sechskant-Bit-Adapter 1/4" für GUT-Lehrenkörper

Der Sechskant-Bit-Adapter dient als Aufnahme eines Gut-Lehrenkörpers in eine antreibende Einheit. Sein Einsatzgebiet findet er beim immer wiederkehrenden Lehren von Gewindelöchern mit einer Tiefe von bis zu 4 x D.

Durch die Ausführung der Drehbewegung mittels einer Antriebseinheit (z.B. Akkuschauber, Druckluftschrauber oder Bohrmaschine) wird ein ermüdungsfreies Arbeiten im Dauerbetrieb ermöglicht.

Hexagon bit adapters 1/4" for gauging bodies "GO"

The hexagon bit adapter serves as holder for the gauge body "GO" in a power driven unit. It is used for repeatably gauging thread holes with a maximum depth of 4 x D.

As a power driven unit such as cordless or pressurised air screwdrivers or drill machines provide the rotation, an effortless and long-term working is possible.



Max. Gewindetiefe
Max. thread depth

4 x D

Werkzeug-Ident · Tool ident

L0091070

Metrische Gewinde Metric threads	Unified-Gewinde Unified threads	Whitworth-Rohrgewinde Whitworth pipe threads	Empf. Drehmoment Recommended torque	Dimens.-Ident
M 2 - M 3	Nr. 1 - Nr. 4	—	6 Ncm	.02.5
M 4 - M 6	Nr. 5 - Nr. 12	—	8 Ncm	.04
M 8 - M10	1/4 - 3/8	G 1/16 - G 1/8	14 Ncm	.05.5
M12 - M14	7/16 - 1/2	G 1/4	20 Ncm	.07
M16 - M18	9/16 - 5/8	G 3/8	30 Ncm	.09
M20 - M24	3/4 - 15/16	G 1/2 - G 5/8	40 Ncm	.12

GUT-Lehrenkörper auf Anfrage (nicht im Lieferumfang enthalten)
Gauging bodies "GO" upon request (not included)

Abziehhülsen

Zum Austausch der Lehrenkörper bei Gewindetiefen-Lehrdornen

Pulling sleeves

For the exchange of gauging bodies in thread depth plug gauges



Werkzeug-Ident · Tool ident

L0091040

Aufnahme-Durchmesser Seat diameter	Dimens.-Ident
2,5	.02.5
4	.04
5,5	.05.5
7	.07
9	.09
12	.12



Funkempfänger i-Stick für Ausführungen „digital IW“

Inklusive USB-Stick mit MarCom Software Standard zur Verwendung mit einem Gewindetiefen-Lehrdorn

- Frequenzband 2.400 MHz
- Max. Funkdistanz 6 m
- Datenschnittstelle USB
- Systemanforderung:
PC mit Microsoft® Excel® (ab 97), Microsoft® Windows® (ab XP) und USB-Schnittstelle (ab 1.1), sowie min. 10 MB freier Festplattenspeicher

Wireless receiver i-Stick for versions “digital IW”

Includes USB stick with MarCom Software Standard for use with a thread depth plug gauge

- Frequency band 2.400 Mhz
- Max. communication range 6 m
- Data interface USB
- System requirement:
PC with Microsoft® Excel® (97 or later version), Microsoft® Windows® (XP or later version) and USB port (from 1.1), and min. 10 MB available hard disk space



Werkzeug-Ident · Tool ident		L0091500
	Dimens.-Ident	
i-Stick + Software MarCom Standard	.01	●

MarCom Software Professional für Ausführungen „digital IW“

Als Erweiterung zum Funkempfänger i-Stick zur Verwendung mit bis zu 8 Gewindetiefen-Lehrdornen

MarCom Software Professional for versions “digital IW”

As accessory for wireless receiver i-Stick for use with up to 8 thread depth plug gauges

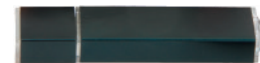

Werkzeug-Ident · Tool ident		L0091510
	Dimens.-Ident	
Software MarCom Professional	.08	●

Hakenschlüssel

Zum Festziehen der Kontermutter

Hook spanner

For tightening the counter nut



Werkzeug-Ident · Tool ident					L0091410
Nenn Durchmesser Nominal dia.	Metrische Gewinde Metric threads	Unified-Gewinde Unified threads	Whitworth-Rohrgewinde Whitworth pipe threads	Dimens.-Ident	
≤ 3 mm	M 2 - M 3	Nr. 1 - Nr. 4	–	.02.5	●
> 3 - 6 mm	M 4 - M 6	Nr. 5 - Nr. 12	–	.04	●
> 6 - 10 mm	M 8 - M10	1/4 - 3/8	G 1/16 - G 1/8	.05.5	●
> 10 - 14 mm	M12 - M14	7/16 - 1/2	G 1/4	.07	●
> 14 - 18 mm	M16 - M18	9/16 - 5/8	G 3/8	.09	●
> 18 - 24 mm	M20 - M24	3/4 - 15/16	G 1/2 - G 5/8	.12	●

- Product Finder
- M
- MF
- UNC
- UNF
- G
- Rp
R, Rc
- NPT, NPTF
- BSW
- Pg
- MJ
UNJC, UNJF
- EG (STI)
SELF-LOCK
- Tr, Tr-F
Rd
- Glatt
Smooth
- GT, TD
- Zubehör
Accessories
- Kalibrierung
Calibration
- Tech. Info



- Product Finder
- M
- MF
- UNC
- UNF
- G
- Rp
R, Rc
- NPT, NPTF
- BSW
- Pg
- MJ
UNJC, UNJF
- EG (STI)
SELF-LOCK
- Tr, Tr-F
Rd
- Glatt
Smooth
- GT, TD
- Zubehör
Accessories
- Kalibrieren
Calibration
- Tech. Info





EMUGE bietet Ihnen umfangreiche Leistungen zur Kalibrierung Ihrer Lehren und Messmittel durch unseren Kooperationspartner DECOM UGK GmbH, ein unabhängiges Kalibrierlabor, ansässig im Hause EMUGE. Die DECOM UGK GmbH ist ein seit 1998 DAKKS-akkreditiertes Prüflabor für Länge und weitere geometrische Größen (z.B. Gewindelehren, Messuhren, Feinzeiger, Fühlhebelmessgeräte, Bügelmessschrauben, Messschieber, usw.) gemäß EN/ISO/IEC 17025. Die messtechnische Ausstattung, das Personal und die Umgebungsbedingungen unterliegen der Überwachung durch die DAKKS (Deutsche Akkreditierungsstelle GmbH).

EMUGE offers you comprehensive services for the calibration of your gauges and measuring tools by our cooperation partner DECOM UGK GmbH, an independent calibration laboratory on the premises of EMUGE-Werk at Lauf. DECOM UGK GmbH has been a DAKKS-accredited calibration laboratory for length and other geometric quantities (e.g. thread gauges, dial gauges, dial gauge instruments, dial test indicators, micrometer gauges, caliper gauges etc.) acc. EN/ISO/IEC 17025 since 1998. The technical measuring equipment, the personnel and the environmental conditions are subject to surveillance by the DAKKS (German Accreditation Body).



www.decom-ugk.de

Gerätetechnische Ausstattung

Bezugsnormale und Normalmesseinrichtungen:

Für sämtliche im Kundenauftrag durchgeführten Messungen wird der Anschluss an nationale und internationale Normale sichergestellt. Dazu werden Normale und Normalmesseinrichtungen bereitgehalten, die in regelmäßigen Abständen durch innerhalb der WECC anerkannte Kalibrierstellen rekaliert werden.

Rückführbarkeit der Messgeräte auf nationale Normale

Für die Durchführung der Prüfmittelüberwachung von Betriebsmitteln steht ein umfangreicher Gerätepark zu Verfügung. Die Messgeräte und Messeinrichtungen werden durch regelmäßige betriebsinterne Kalibrierung unter Verwendung der Bezugsnormale und Normalmesseinrichtungen an nationale Normale angeschlossen.

Als Ansprechpartner dient Ihnen die gesamte Vertriebsorganisation des Firmenverbundes EMUGE-FRANKEN (www.emuge-franken.com/vertrieb).

Technical Equipment

Reference Standards and Standard Measuring Devices:

The compliance with national and international standards of all measurements commissioned by customers is guaranteed. All necessary standards and standard measuring devices are at our disposal and are regularly recalibrated by calibration laboratories authorised by the WECC.

Traceability of measuring devices to national standards.

An extensive range of equipment is available to conduct inspection monitoring of operating equipment. The measuring devices and measuring equipment are certified to be in compliance with national standards by means of regular in-house calibrations using reference standards and standard measuring devices

For more information please contact the sales organisation of the company association EMUGE-FRANKEN (www.emuge-franken.com/sales).

- Product Finder
- M
- MF
- UNC
- UNF
- G
- Rp, R, Rc
- NPT, NPTF
- BSW
- Pg
- MJ, UNJC, UNJF
- EG (STI) SELF-LOCK
- Tr, Tr-F, Rd
- Glatt, Smooth
- GT, TD
- Zubehör, Accessories
- Kalibrieren, Calibration
- Tech. Info





Deutsche Akkreditierungsstelle GmbH

Beliehene gemäß § 8 Absatz 1 AkkStelleG i.V.m. § 1 Absatz 1 AkkStelleGBV
Unterzeichnerin der Multilateralen Abkommen
von EA, ILAC und IAF zur gegenseitigen Anerkennung

Akkreditierung



Die Deutsche Akkreditierungsstelle GmbH bestätigt hiermit, dass die

DECOM UGK Werkzeugtechnik GmbH
Gartenstraße 7, 91207 Lauf a. d. Pegnitz

für ihr Kalibrierlaboratorium:

DECOM UGK GmbH
Nürnberger Straße 96 – 100, 91207 Lauf a. d. Pegnitz

die Kompetenz nach DIN EN ISO/IEC 17025:2005 besitzt, Kalibrierungen in folgenden Bereichen durchzuführen:

Dimensionelle Messgrößen

Länge

- Gewinde
- Längenmessmittel
- Durchmesser
- Formabweichung

Die Akkreditierungsurkunde gilt nur in Verbindung mit dem Bescheid vom 16.08.2012 mit der Akkreditierungsnummer D-K-17567-01 und ist gültig bis 15.08.2017. Sie besteht aus diesem Deckblatt, der Rückseite des Deckblatts und der folgenden Anlage mit insgesamt 3 Seiten.

Registrierungsnummer der Urkunde: **D-K-17567-01-00**

Braunschweig, 16.08.2012

Im Auftrag
Dr. Michael Wolf
Leiter Abteilung 5

Siehe Hinweise auf der Rückseite

Überwachungsprüfung nach VDI/VDE/DGQ-Richtlinie 2618, Blatt 4.8 „Ü“

- Reinigen
- Entmagnetisieren
- Sichtprüfung auf Beschädigung
- Nacharbeit leichter Beschädigungen mit Ölstein oder Läppleinen
- Kennzeichnung feststellen, evtl. Ident-Nummer festlegen und aufbringen
- Temperieren (min. 5 Stunden)
- Sichtprüfung der korrekten Kennzeichnung, ggf. Farbkennzeichnung
- Kennwertermittlung: Flankendurchmesser am Gewindeanfang an 2 Messstellen um 90° versetzt
- Auswertung der Messergebnisse und Erstellung des Kalibrierscheines
- Konservierung und Stückverpackung

Alle erforderlichen Daten und Messergebnisse werden in einem Kalibrierschein (siehe Muster) dokumentiert.

Inspection monitoring according to VDI/VDE/DGQ-directive 2618, sheet 4.8 "Ü"

- Cleaning
- Demagnetizing
- Visual inspection for damage
- Rework of minor damages with oil stone and lapping cloth
- Determine marking, if applicable, establish ID number and apply marking
- Tempering (min. 5 hours)
- Visual inspection for correct marking, if applicable colour marking.
- Determination of specific values: pitch diameter at the start of the thread on 2 measuring locations off-set by 90°.
- Evaluation of measuring results and creation of calibration certificate
- Preservation and single packaging

All necessary data and measuring results will be documented in a calibration certificate (see sample).

DECOM
UGK GmbH

Prüflabor zur Prüfmittelüberwachung gemäß DIN ISO 9001 und VDI/VDE-Richtlinien 2618ff. Akkreditiert nach DIN EN ISO/IEC 17025.

Decom UGK GmbH
Nürnberger Str. 96-100
D-91207 Lauf a.d. Pegnitz

Werks-Kalibrierschein
Proprietary Calibration-Certificate

Gegenstand / Object: Gewinde-Grenzlehndrom

Die Kalibrierung erfolgt durch Vergleich mit Bezugsnormen bzw. Bezugsnormaleinrichtungen, die in einer innerhalb der Western European Cooperation (WECC) akkreditierten Kalibrierstelle kalibriert wurden und damit rückgeführt sind auf die nationalen Normale, mit denen die Physikalisch-Technische Bundesanstalt (PTB) die physikalischen Einheiten in Übereinstimmung mit dem Internationalen Einheitensystem (SI) darstellt.

Für die Einhaltung einer angemessenen Frist zur Wiederholung der Kalibrierung ist der Benutzer verantwortlich.

The calibration is performed by comparison with reference standards or standard measuring equipment which are calibrated by a calibration laboratory accredited within the Western European Calibration Cooperation (WECC) and thus traceable to the national measurement standards maintained by the Physikalisch-Technische Bundesanstalt (PTB) for the realisation of the physical units according to the international system of units (SI).

All users are responsible for the observation of an appropriate period for recalibration.

Dieser Kalibrierschein darf nur vollständig und unverändert weiterverbreitet werden. Auszüge oder Änderungen bedürfen der Genehmigung der ausstellenden Firma. Dieser Kalibrierschein wurde per EDV erstellt und ist ohne Unterschrift gültig. This calibration certificate may not be reproduced other than in full except with the permission of the issuing company. This calibration certificate was made by electronic data processing and is legal without signature.

Decom UGK GmbH
Nürnberger Str. 96 - 100
91207 Lauf a.d. Pegnitz

Fon: +49(0)9123 186 200
Fax: +49(0)9123 186 401
info@decom-ugk.de
www.decom-ugk.de

Geschäftsführer:
Ulrike Gimpel-Krienereder
Peter Ludwig
AG Nürnberg HRB 9730

HypoVereinsbank Lauf
BLZ 780 200 70
Konto-Nr. 1000 237 007

UGK-Ident Nr.:
DE 133 541 469

Prüfmitteltyp : Gewinde-Grenzlehndrom

Sollmaße und Toleranzen

Flankendurchmesser, Gutseite, neu	: 16,3920 mm ± 0,0070 mm
Flankendurchmesser, Gutseite, abgn.	: 16,3710 mm
Flankendurchmesser, Ausschuss, neu	: 16,6070 mm ± 0,0070 mm
Flankendurchmesser, Ausschuss, abgn.	: 16,5920 mm

Ergebnisse

Pos.	Messwerte	Abweichung	außerhalb der Toleranz
A1	Gutseite 16,3901 mm	- 0,0019 mm	
B1	16,3912 mm	- 0,0008 mm	
A1	Ausschussseite 16,6078 mm	+ 0,0008 mm	
B1	16,6072 mm	+ 0,0002 mm	

7 Bemerkung

8 Prüfentscheid
Prüfmittel hält die Spezifikationen ein

9 Prüfgert
ULM 450 N: 5382; Dreirahtmethode

10 Anschluß ans nationales Normal
Lehndrom.metas:111-04876

11 Messunsicherheit (P=95%)
U = (2,50 + L x 1,25) µm, L in m

12 Prüfanweisung
VDI/VDE/DGQ-Richtlinie 2618, Blatt 4.8

Für die Einhaltung einer angemessenen Frist zur Rekalibrierung ist der Benutzer verantwortlich. Messergebnisse außerhalb der zulässigen, jedoch innerhalb der um die Messunsicherheit erweiterten Grenzwerte werden nicht zurückgewiesen und als in Ordnung beurteilt (DIN EN ISO 14253-1).

- 1 Kalibrierschein-Nr. zur eindeutigen Zuordnung der Kalibrierung
Number of calibration certificate to clearly assign the calibration
- 2 Messmittelhersteller
Manufacturer of measuring device
- 3 Eindeutige Ident-Nr. des Messmittels zur Zuordnung des Kalibrierscheines
Unique ID number of measuring device for clear assignment to calibration certificate
- 4 Name und Anschrift des Kunden
Name and address of customer
- 5 Auftragsnummer
Order number
- 6 Verantwortlicher Prüfer für den Prüfentscheid
Inspecting person responsible for the inspection decision

- 7 Besondere Hinweise und Bemerkungen zum Messmittel
Specific notes and remarks concerning the measuring device
- 8 Besondere Hinweise und Bemerkungen zum Prüfentscheid
Specific notes and remarks concerning the inspection decision
- 9 Für die Kalibrierung verwendetes Prüfgerät
Measuring device used for the calibration
- 10 Angabe des Bezugsnormales zur Rückführung des Messwertes
Information on reference standard for traceability of measuring values
- 11 Messunsicherheitsangabe
Information on measurement uncertainty
- 12 Angabe der Prüfanweisung
Information on inspection directives

- Product Finder
- M
- MF
- UNC
- UNF
- G
- Rp
R, Rc
- NPT, NPTF
- BSW
- Pg
- MJ
UNJC, UNJF
- EG (STI)
SELF-LOCK
- Tr, Tr-F
Rd
- Glatt
Smooth
- GT, TD
- Zubehör
Accessories
- Kalibrieren
Calibration
- Tech. Info



- Product Finder
- M
- MF
- UNC
- UNF
- G
- Rp
R, Rc
- NPT, NPTF
- BSW
- Pg
- MJ
UNJC, UNJF
- EG (STI)
SELF-LOCK
- Tr, Tr-F
Rd
- Glatt
Smooth
- GT, TD
- Zubehör
Accessories
- Kalibrieren
Calibration
- Tech. Info

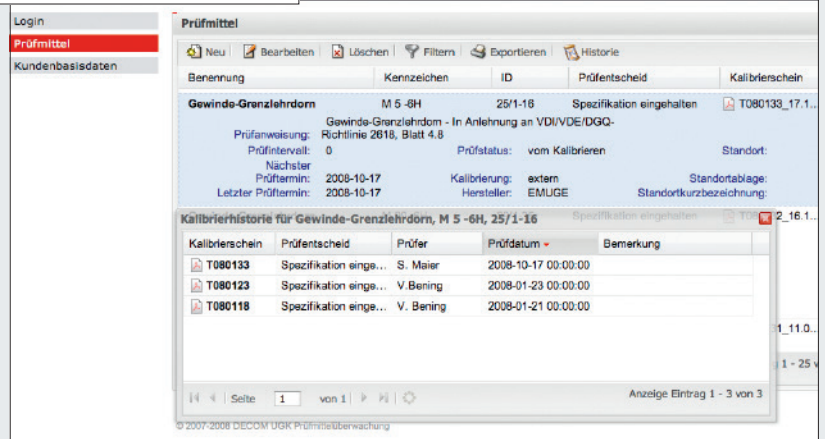
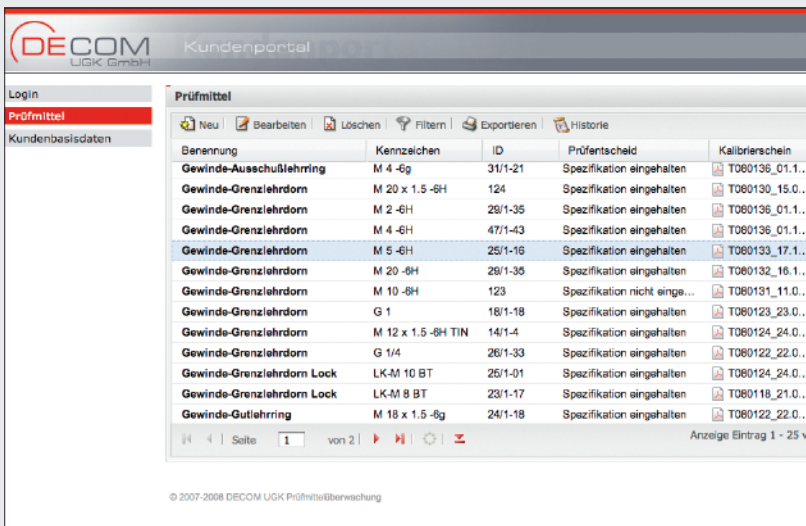

KalimeroNet – einfachste Bedienung – Kalibrierscheine weltweit online verfügbar – keine Software-Installation

Welche Funktionen beinhaltet KalimeroNet?

- Kalibrierscheine sind direkt abrufbar und als PDF hinterlegt
- Erfassung eigener Kundenbasisdaten wie Standorte und Lagerorte
- Prüf- und Kalibrieranweisungen können als Dateianhang verwaltet werden und lassen sich dem Prüfmittel zuordnen
- Zugriff auf alle bisherigen Kalibrierungen in der Historienübersicht
- Datenexport in Microsoft® Excel® für eigene Ausdrücke
- Umfangreiche Sortier- und Filterfunktionen verschaffen den gewünschten Überblick wie z.B. Prüffälligkeiten
- Verwaltung eigenkalibrierter Messmittel mit Kalibrierschein als Dateianhang möglich
- Vergabe von Nutzerprofilen durch DECOM UGK ist möglich

Wie kann ich die Leistungen von KalimeroNet nutzen?

Sie benötigen einen Internetzugang. Die Nutzung von KalimeroNet über unser Kundenportal steht ausschließlich DECOM UGK Kunden zur Verfügung. Die Nutzung ist unentgeltlich.

Wie bekomme ich meine persönlichen Daten für die Kundenportal-Registrierung?

Sie müssen sich einmalig über das Online-Formular mit Ihren Anmeldedaten registrieren. Das Passwort kann nachträglich von Ihnen geändert werden.

Unter www.decom-ugk.de/user/login können Sie sich über unseren Gastzugang von der einfachen Bedienung überzeugen. Alternativ können Sie eine Kurzbeschreibung zu KalimeroNet von unserer Internetseite unter www.decom-ugk.de/hp/download herunterladen.

KalimeroNet – easiest handling – calibration sheets available online worldwide – no software installation necessary

Which functions does KalimeroNet offer you?

- Calibration sheets can be called off directly, and are filed in PDF format
- Registration of proper customer data, like location and storage location is possible
- Inspection and calibration instructions can be administrated as file attachments, and allocated to individual inspection tools
- Access to all past calibrations in the history file
- Data export in Microsoft® Excel® for your own printout
- Comprehensive sorting and filter functions provide full control, e.g. of due inspection dates
- Administration of self-calibrated measuring tools with calibration sheet as file attachment is possible
- User profiles can be provided by DECOM UGK

How can I use the advantages of KalimeroNet?

All you need is an Internet access. The use of KalimeroNet through our customer portal is available only to DECOM UGK customers. The use of KalimeroNet is free of charge.

How do I get my personal data for registration in the customer portal?

You have to register one time only through our online form with your customer data. You can change your password subsequently.

Under our guest log-in, www.decom-ugk.de/user/login you can convince yourself of the easy handling of KalimeroNet.

As an alternative, you can download a brief description of KalimeroNet from our Internet website under www.decom-ugk.de/hp/download.

Technische Informationen

Technical Information

Seite · Page

6.1	Allgemeines General information	636
6.2	Vorteile der EMUGE-Gewindelehren Advantages of our EMUGE thread gauges	636
6.3	EMUGE-Gewindelehren – Prüftechnik in Perfektion EMUGE thread gauges – Gauging technology to perfection	637
6.4	Gewindelehren für Innengewinde und glatte Lehren für Gewindekerndurchmesser Thread gauges for internal threads and smooth gauges for thread minor diameters	638 - 639
6.5	Gewindelehren für Außengewinde und glatte Lehren für Gewindeaußendurchmesser Thread gauges for external threads and smooth gauges for thread major diameters	640 - 641
6.6	Gewinde-Tiefenlehrdorne GT thread depth plug gauges	642 - 646
6.7	Glatte Lehrdorne für Bohrungen nach DIN EN ISO 1938-1 Smooth plug gauges for drilled holes acc. DIN EN ISO 1938-1	647
6.8	Glatte Lehrringe für Wellen nach DIN EN ISO 1938-1 Smooth ring gauges for shafts acc. DIN EN ISO 1938-1	648
6.9	Lehrung von anderen Gewinden Gauging of other threads	649 - 654

Product
Finder

M

MF

UNC

UNF

G

Rp
R, Rc

NPT, NPTF

BSW

Pg

MJ
UNJC, UNJFEG (STI)
SELF-LOCKTr, Tr-F
RdGlatt
Smooth

GT, TD

Zubehör
AccessoriesKalibrieren
Calibration

Tech. Info



Die Technischen Informationen der jeweiligen Kapitel dieses Kataloges sind in vielen Landessprachen auch als separate Druckerzeugnisse verfügbar. Bitte wenden Sie sich an den für Sie zuständigen Vertriebspartner.

The technical information complementing the various chapters of this catalogue is available also as a separate printed booklet in many different languages. Please speak to your usual sales contact.

- Product Finder
- M
- MF
- UNC
- UNF
- G
- Rp
R, Rc
- NPT, NPTF
- BSW
- Pg
- MJ
UNJC, UNJF
- EG (STI)
SELF-LOCK
- Tr, Tr-F
Rd
- Glatt
Smooth
- GT, TD
- Zubehör
Accessories
- Kalibrieren
Calibration
- Tech. Info**

6.1 Allgemeines

Für das Metrische ISO-Gewinde ist in DIN ISO 1502 ein Lehrensystem festgelegt mit dem Zweck, eine uneingeschränkte Austauschbarkeit der Werkstückgewinde zu gewährleisten.

Es gelten folgende Grundsätze:

1. Der Hersteller darf kein Werkstückgewinde liefern, dessen Gewinde-Istmaß außerhalb der festgelegten Grenzen liegt (z.B. der Flankendurchmesser und der Paarungsflankendurchmesser).
2. Der Besteller darf kein Werkstückgewinde zurückweisen, dessen Gewinde-Istmaß innerhalb der festgelegten Grenzen liegt (z.B. der Flankendurchmesser und der Paarungsflankendurchmesser).

Natürlich werden heute in der modernen Gewindefertigung auch andere Prüfmethode angewandt, z.B. Messen mit anzeigenden Messgeräten.

Bei Anwendung anderer Methoden ist darauf zu achten, dass diese zu gleichen Ergebnissen führen.

In Zweifelsfällen sind für das Metrische ISO-Gewinde die in der Norm DIN ISO 1502 empfohlenen Lehren für die Prüfung entscheidend. Für andere Gewindesysteme (z.B. Amerikanische Gewinde) gelten andere Lehrennormen.

Wird in der Fertigung hauptsächlich durch Messen geprüft, so ist es unumgänglich, dass eine stichprobenmäßige Prüfung mit den genormten Lehren durchgeführt wird. Die Bezugstemperatur für die Maße der Lehren und Werkstücke ist 20 °C. Wird bei anderen Temperaturen geprüft, sind die Ausdehnungskoeffizienten zu berücksichtigen.

6.2 Vorteile der EMUGE-Gewindelehren

- Gealterter Lehrenstahl, dadurch sehr maßstabil
- Härte deutlich über dem genormten Mindestwert
- Hartstoffschichten zur höheren Verschleißfestigkeit der Gut-Seite möglich
- Großes Lagersortiment an Standard- und Sondertoleranzen
- Kurze Lieferzeit
- Sonderkonstruktionen auf Anfrage
- Auf Wunsch mit Werkskalibrierschein (durch neutrales Prüflabor Fa. DECOM im Hause)
- Kostenfreie Beschriftung von kundenspezifischen Angaben bei Neu-Fertigung und Sonder-Anfertigung

6.1 General information

For the Metric ISO thread, a gauge system is specified in DIN ISO 1502 for the purpose of securing the unlimited exchangeability of workpiece threads.

The following basic principles apply:

1. The manufacturer must not supply a workpiece thread the actual thread size of which is outside of the specified limits (e.g. pitch diameter or mating pitch diameter).
2. The buyer must not reject a workpiece thread the actual thread size of which is inside of the specified limits (e.g. pitch diameter or mating pitch diameter).

In modern thread production, there are of course other inspection methods also, e.g. measuring with dial-type measuring instruments. Whenever other methods are applied it is important to make sure that the same results are achieved.

In any case of doubt, the gauges recommended in the standard DIN ISO 1502 will decide the result of the inspection for the Metric ISO thread.

For other thread systems (e.g. American threads), other gauge standards apply.

If the inspection work in production is done mainly by measuring, it is still absolutely necessary to perform random sample inspection with the standardised gauges. The reference temperature for the gauge and workpiece dimensions is 20 °C. If inspections are done at other temperatures, the corresponding expansion coefficients have to be taken into account.

6.2 Advantages of our EMUGE thread gauges

- Aged gauge steel, hence extremely true-to-dimension
- Hardness noticeably over the standardised minimum requirements
- Hard surface coatings for extra high wear resistance available on the go side
- Large stock of standard and special tolerances
- Short delivery
- Special designs available upon request
- Inspection certificates available upon request (issued by independent in-house inspection lab DECOM)
- Free-of-charge laser marking to customer's specifications on gauges coming from new production and specially produced gauges



6.3 EMUGE-Gewindelehren – Prüftechnik in Perfektion

6.3 EMUGE thread gauges – Gauging technology to perfection

Product
Finder

M

MF

UNC

UNF

G

Rp
R, Rc

NPT, NPTF

BSW

Pg

MJ
UNJC, UNJFEG (STI)
SELF-LOCKTr, Tr-F
RdGlatt
Smooth

GT, TD

Zubehör
AccessoriesKalibrieren
Calibration

Tech. Info

Ab \varnothing 5,5 mm erhält jeder Gutlehndorn eine **Schmutznut**, dadurch sichere Lehrung auch unter schwierigen Einsatzbedingungen

Starting from dia. 5.5 mm each go plug gauge is provided with a dirt flute, for safe gauging even under difficult conditions

Eindeutige Ident-Nr. jeder Gewindelehre stellt die notwendige EMUGE werksinterne Rückverfolgbarkeit sicher

Individual ident no. for each single gauge for safe tracing back to production at EMUGE

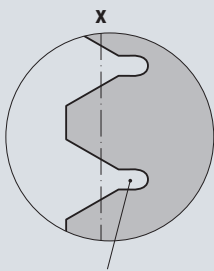

Funktionsgerechte **Kern-Freiarbeitung** der Ausschuss-Gewindelehren
Recessed minor thread diameter of the no-go gauges for safe function

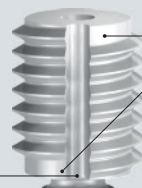

Unvollständige Gewindegänge werden bis zum Beginn des Vollprofils **entfernt**, dadurch stabiler Gewindefang
Incomplete threads are removed until the beginning of the full thread, in order to create a stable thread start



Lehrgriff mit 2 Beschriftungsflächen

Ausreichend Platz für kundenspezifische Angaben (auf Wunsch auch von EMUGE durchführbar)

Gauge handles with double surfaces for marking, leaving sufficient space for customer's specific requirements (marking to be provided by EMUGE upon request)

Gerändelter Griff

(leichte Handhabung auch mit öligen Fingern)

Knurled handles

(safe handling even with greasy fingers)

Rote Farbkennzeichnung der Ausschussseite
Red marking of the no-go side



Einführansatz

zur verbesserten Einführung des Ausschusslehrenkörpers

Reduced thread start

for easy insertion of the no-go gauge body

$\leq \varnothing$ 40 mm

Form R nach DIN 2240-1 mit Einsteckkegel.
Gut- und Ausschussseite auf einem Lehrgriff.

$> \varnothing$ 40 mm und $\leq \varnothing$ 200 mm

Ähnlich DIN 2240-2 mit Kugelbefestigung.
Gut- und Ausschussseite auf je einem Lehrgriff.
Sicherer Halt bei Lehrung und Prüfung der Lehre im 3-Draht-Messverfahren.

$\leq \varnothing$ 40 mm

Form R acc. DIN 2240-1 with fixing taper.
Go and no-go side on one gauge handle.

$> \varnothing$ 40 mm und $\leq \varnothing$ 200 mm

Made acc. DIN 2240-2 with ball fixture.
Go and no-go side are mounted each on a single handle.
Safe grip for gauging and checking of the gauge in a 3-wire measuring process.



- Product Finder
- M
- MF
- UNC
- UNF
- G
- Rp
R, Rc
- NPT, NPTF
- BSW
- Pg
- MJ
UNJC, UNJF
- EG (STI)
SELF-LOCK
- Tr, Tr-F
Rd
- Glatt
Smooth
- GT, TD
- Zubehör
Accessories
- Kalibrieren
Calibration
- Tech. Info

6.4 Gewindelehren für Innengewinde und glatte Lehren für Gewindekerndurchmesser

Für die Lehrung des Innengewindes werden der Gewinde-Gutlehrdorn und der Gewinde-Ausschusslehrdorn verwendet. Bis Gewindedurchmesser 40 mm sind Gut- und Ausschusslehrdorn auf einen gemeinsamen Griff montiert und werden als Gewinde-Grenzlehdorn bezeichnet. Für Ausnahmefälle sind Griffe für Gewinde-Grenzlehdorne bis Gewindedurchmesser 62 mm nach DIN 2240-2 genormt. Zur Lehrung des Innengewinde-Kerndurchmessers wird ein (glatter) Gut- und Ausschusslehrdorn empfohlen.

G-GUT-LD



Gewinde-Gutlehrdorn

- Der Gewinde-Gutlehrdorn prüft das sogenannte Paarungsmaß des Innengewindes und die Einschraubbarkeit. Er prüft hierbei das Kleinmaß des Innengewinde-Flankendurchmessers D_2 einschließlich gewisser Formabweichungen im Gewinde, z.B. Steigungs- und Gewindeprofilwinkel-Abweichungen. Außerdem prüft er auch das Kleinmaß des Außendurchmessers. Nicht geprüft wird der Kerndurchmesser D_1 des Innengewindes.
- Der Gewinde-Gutlehrdorn muss sich von Hand ohne Anwendung besonderer Kraft auf ganze Länge des Werkstückgewindes einschrauben lassen. Die zulässige Abnutzung des Gewinde-Gutlehdorns wird durch Messen nach der Drei-Draht-Methode festgestellt. Der Gewinde-Gutlehdorn unterliegt stärkerer Abnutzung und soll regelmäßig überprüft werden. EMUGE empfiehlt deshalb, die Gewinde-Gutlehdorne in hartverchromter oder beschichteter Ausführung zu verwenden.
- Baumaße der Gewinde-Gutlehdorne nach DIN 2281 und DIN 2282.
- Der Gewinde-Gutlehdorn hat volles Gewindeprofil auf seiner Gewindelänge. Es ist zu beachten, dass die Gewindelänge nicht kleiner als 80% der Einschraublänge des Werkstückgewindes ist. Gewinde-Gutlehdorne ab Gewindedurchmesser 5,5 mm werden von EMUGE mit einer Schmutznut versehen.
- Nach DIN ISO 1502 sind keine sogenannten Abnahme-Gutlehdorne genormt.
- Es ist empfehlenswert, die neuen Lehdorne immer in der Fertigung zu benutzen und diejenigen, welche an der Abnutzungsgrenze liegen, für die Abnahme vorzusehen.

6.4 Thread gauges for internal threads and smooth gauges for thread minor diameters

The go thread plug gauge and the no-go thread plug gauge are used for the gauging of internal threads. Go and no-go plug gauges are mounted on a common handle for thread diameters up to 40 mm and are designated as go/no-go thread plug gauges. For exceptional cases handles for go/no-go thread plug gauges up to a thread diameter of 62 mm are standardised in DIN 2240-2. A (smooth) go and no-go plug gauge is recommended for gauging the internal thread minor diameter.

Go thread plug gauge

- The go thread plug gauge checks the so-called "mating size" of the internal thread and the screwing-in capability. In doing so, it checks the smallest size of the internal thread pitch diameter D_2 including certain form deviations in the thread, e.g. pitch and thread profile angle deviations. It also checks the smallest size of the major diameter. The minor diameter D_1 of the internal thread is not checked.
- The go thread plug gauge must be able to be screwed by hand into the full length of the workpiece thread without using particular force. The permissible wear of the go thread plug gauge is determined by measurement based on the three-wire-method. The go thread plug gauge is subject to heavy wear and should be checked at regular intervals. EMUGE therefore recommends using go thread plug gauges in the hard-chrome-plated or coated version.
- Dimensions of the go thread plug gauge acc. DIN 2281 and DIN 2282.
- The go thread plug gauge has a full thread profile along its thread length. It should be noted that the thread length is not less than 80% of the screw-in length of the workpiece thread. Go thread plug gauges, starting from a thread diameter of 5.5 mm, are provided by EMUGE with a dirt flute.
- According to DIN ISO 1502, no so-called "acceptance" go plug gauges are standardised.
- It is advisable to always use the new plug gauges for production and keep those that are close to the wear limit for acceptance.

G-AUS-LD



Gewinde-Ausschusslehdorn

- Der Gewinde-Ausschusslehdorn prüft, ob der Istflankendurchmesser des Werkstück-Innengewindes das vorgeschriebene Größtmaß überschreitet. Der Innengewinde-Außendurchmesser und Innengewinde-Kerndurchmesser wird nicht geprüft.
- Der Gewinde-Ausschusslehdorn darf sich von Hand ohne Anwendung besonderer Kraft in das Werkstückgewinde (von beiden Seiten) nicht mehr als zwei Umdrehungen einschrauben lassen. Die zwei Umdrehungen werden beim Ausschrauben des Lehdorns festgestellt.
- Der Gewinde-Ausschusslehdorn hat eine Gewindelänge von mindestens drei Gängen. Das Gewindeprofil hat verkürzte Flanken.
- Die Lehren sind mit einem roten Farbring markiert.
- Baumaße nach DIN 2283 und DIN 2284.

No-go thread plug gauge

- The no-go thread plug gauge checks whether the actual pitch diameter of the workpiece internal thread exceeds the prescribed largest size. The internal thread major diameter and internal thread minor diameter are not checked.
- It must not be possible to screw the no-go thread plug gauge into the workpiece thread by hand for more than two revolutions (from both sides) without the use of particular force. The two revolutions are determined on screwing out the plug gauge.
- The no-go thread plug gauge has a thread length of at least three threads. The thread profile has a truncated crest.
- The gauges are marked with a red coloured ring.
- Dimensions acc. DIN 2283 and DIN 2284.

6.4 Gewindelehren für Innengewinde und glatte Lehren für Gewindekerndurchmesser

6.4 Thread gauges for internal threads and smooth gauges for thread minor diameters

G-GR-LD

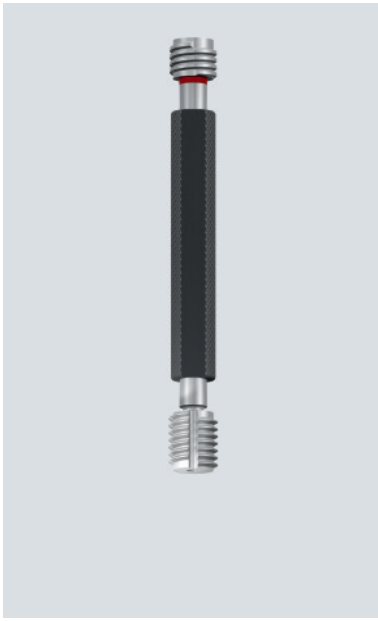

Gewinde-Grenzlehndorn

- Der Gewinde-Grenzlehndorn ist die Kombination von Gewinde-Gutlehndorn und Gewinde-Ausschusslehndorn auf einem Griff.
- Die Baumaße der Gewinde-Grenzlehndorne sind bis Nennmaßdurchmesser 40 mm nach DIN 2280 festgelegt. Die Funktionsweise entspricht den vorher beschriebenen Gewinde-Gut- und -Ausschusslehndornen.

Go/no-go thread plug gauge

- The go/no-go thread plug gauge is the combination of a go thread plug gauge and a no-go thread plug gauge on one handle.
- The dimensions of the go/no-go thread plug gauges are specified up to a nominal dimension diameter of 40 mm in DIN 2280. The functionality corresponds to the go and no-go thread plug gauges previously described.

Glatt-GR-LD



Lehren für den Innengewinde-Kerndurchmesser

- Der Innengewinde-Kerndurchmesser D_1 wird mit einem glatten, zylindrischen Gut- und Ausschusslehndorn bzw. Grenzlehndorn geprüft. Da sich der Kerndurchmesser durch das Gewindeschneiden verändern kann, ist eine Überprüfung nach der Gewindefertigstellung notwendig. Für geformte Innengewinde sind beim Metrischen Gewinde eigene Lehren für die erweiterte Kerndurchmesser-Toleranz verfügbar. Grundsätzlich soll vor Lehrung des Innengewinde-Flankendurchmessers eine Prüfung des Innengewinde-Kerndurchmessers erfolgen.
- Der glatte Gutlehndorn muss sich von Hand ohne Anwendung besonderer Kraft durch das Werkstückgewinde führen lassen.
- Der glatte Ausschusslehndorn darf sich in das Werkstückgewinde von beiden Seiten nicht tiefer als eine Steigung ($1 \times P$), vom Gewindefang aus, einführen lassen.

Gauges for the internal thread minor diameter

- The internal thread minor diameter D_1 is checked with a smooth, cylindrical go and no-go plug gauge or a go/no-go plug gauge. As the minor diameter can change through thread tapping, an inspection is required after the thread has been completed. Specific gauges are available to check the extended minor diameter tolerance of cold-formed Metric internal threads. Basically, the internal thread minor diameter should be checked before gauging the internal thread pitch diameter.
- It must be possible to guide the smooth go plug gauge by hand through the workpiece thread without the use of particular force.
- It must not be possible to insert the smooth no-go plug gauge into the workpiece thread from both sides deeper than one pitch ($1 \times P$) from the start of the thread.

Product Finder

M

MF

UNC

UNF

G

Rp
R, Rc

NPT, NPTF

BSW

Pg

MJ
UNJC, UNJFEG (STI)
SELF-LOCKTr, Tr-F
RdGlatt
Smooth

GT, TD

Zubehör
AccessoriesKalibrieren
Calibration

Tech. Info



Product Finder
M
MF
UNC
UNF
G
Rp R, Rc
NPT, NPTF
BSW
Pg
MJ UNJC, UNJF
EG (STI) SELF-LOCK
Tr, Tr-F Rd
Glatt Smooth
GT, TD
Zubehör Accessories
Kalibrieren Calibration
Tech. Info

6.5 Gewindelehren für Außengewinde und glatte Lehren für Gewindeaußendurchmesser

Für die Leh rung des Außengewin des zur Gutseite wird ein Gewin de-Gutle hrring verwendet, zur Ausschussseite ein Gewin de-Ausschussle hrring.

Die Gewin de-Le hrringe sollen mit Gewin de-Abnutzungs-Prüfdornen regelmäßig über wach t werden. Zur Prüfung, insbeson dere von neuen Le hrringen, werden Gut- und Ausschuss-Prüfdorne (Gegenle hrdorne) verwendet. Der Gewin de-Außendurchmesser d wird mit glatten Gut- und Ausschussle hrringen oder Gut- und Ausschuss-Rachenle hren ge prüft.

6.5 Thread gauges for external threads and smooth gauges for thread major diameters

A go thread ring gauge is used for gauging the external thread for the go side, a no-go thread ring gauge for the no-go side. The thread ring gauges should be monitored regularly with thread wear check plug gauges. Check go and no-go plug gauges (check plug gauges) are used for testing, especially with new ring gauges. The major diameter of thread d is tested with smooth go and no-go ring gauges or go and no-go snap gauges.

G-GUT-LR

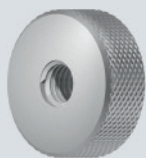

Gewinde-Gutle hrring

- Der Gewin de-Gutle hrring prüft das sogenan nte Paarungsmaß des Außengewin des und die Aufschraubbar keit. Er prüft da bei das Größtmaß des Außengewin de-Flankendurchmessers d_2 einschließ lich gewis ser Formabwei chun gen im Gewin de, z.B. Steigungs- und Gewin deprofil-winkel-Abwei chun gen. Außer dem prüft er, ob das ge ra de Flankenstück ge nügend lang ist, d.h., ob die Run dung am Außengewin de-Kern nicht zu weit in die Profilflanke hi nein reicht. Die Kern run dung selbst wird da bei nicht ge prüft. Auch der Außendurchmesser wird von dieser Leh re nicht ge prüft.
- Der Gewin de-Gutle hrring muss sich von Hand ohne Anwen dung beson derer Kraft über die ganze Län ge auf das Werkstückge win de aufschrauben lassen.
- Der Gewin de-Gutle hrring unterliegt stär ke rer Abnut zung und sollte mit dem Abnut zungs-Prüfdorn regelmäßig über prüft wer den.
- Es ist zu be achten, dass die Gewin delän ge nicht klei ner als 80% der Einschraub län ge des Werk stückge win des ist.
- Bauma ße der Gewin de-Gutle hrringe nach DIN 2285.
- Gewin de-Gutle hrringe in der Stan dardaus führung ohne Schmutz nut (Außengewin de lässt sich vor der Leh rung bes ser rei ni gen als Innengewin de).

Go thread ring gauge

- The go thread ring gauge checks the so-called "mating size" of the external thread and the screwing-on capability. In doing so, it checks the largest dimension of the external thread pitch diameter d_2 including certain form deviations in the thread, e.g. pitch and thread profile angle deviations. It also checks whether the straight flank piece is long enough, i.e. that the curve on the external thread root does not extend too far into the profile flank. The root curve itself is not checked. The major diameter is also not checked by this gauge.
- It must be possible to screw on the go thread ring gauge by hand along the full length of the workpiece thread without the use of particular force.
- The go thread ring gauge is subject to greater wear and should be checked at regular intervals with the wear check plug gauge.
- It should be noted that the thread length is not less than 80% of the thread engagement length of the workpiece thread.
- Dimensions of the go thread ring gauges acc. DIN 2285.
- Go thread ring gauges in the standard version are made without dirt flute (external threads are easier to clean than internal threads prior to gauging).

G-AUS-LR



Gewin de-Ausschussle hrring

- Der Gewin de-Ausschussle hrring soll prü fen, ob der Istflankendurchmesser des Werkstück-Außenge win des das vorgeschrie bene Klein stmaß un ter schreit. Der Außengewin de-Außendurchmesser und -Kerndurchmesser wird da bei nicht ge prüft.
- Der Gewin de-Ausschussle hrring darf sich von Hand ohne Anwen dung beson derer Kraft nicht mehr als zwei Gewin degän ge (2 x P) auf das Werkstückge win de (von bei den Sei ten) schrauben lassen. Die zwei Um drehun gen wer den beim Abschrauben des Le hrrin ges fest gestellt.
- Der Gewin de-Ausschussle hrring muss regelmä ßig mit dem Abnut zungsprüfdorn über wach t wer den.
- Der Gewin de-Ausschussle hrring hat eine Gewin delän ge von min destens drei Gän gen. Das Gewin deprofil hat verkürz te Flanken.
- Die Le hrringe ha ben eine rote Mar kie rung.
- Bauma ße nach DIN 2299.

No-go thread ring gauge

- The no-go thread ring gauge is designed to check whether the actual pitch diameter of the workpiece external thread falls below the prescribed smallest size. The external thread major and minor diameter are not tested here.
- It must not be possible to screw the no-go thread ring gauge onto the workpiece thread (from both sides) by hand for more than two threads without the use of particular force. The two revolutions are determined on screwing off the ring gauge.
- The no-go thread ring gauge must be monitored regularly with the wear check plug gauge.
- The no-go thread ring gauge has a thread length of at least three threads. The thread profile has a truncated crest.
- The ring gauges have a red marking.
- Dimensions acc. DIN 2299.



6.5 Gewindelehren für Außengewinde und glatte Lehren für Gewindeaußendurchmesser

6.5 Thread gauges for external threads and smooth gauges for thread major diameters

Glatt-GUT-LR

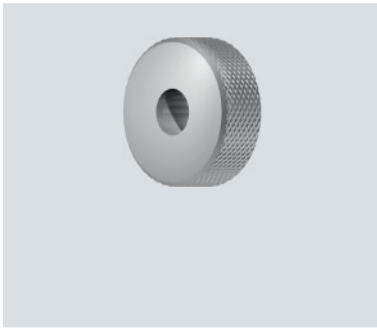

Glatt-AUS-LR

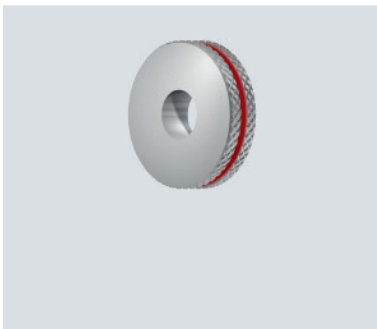

Lehren für Außengewinde-Außendurchmesser

- Der Außengewinde-Außendurchmesser wird mit glatten Gut- und Ausschusslehringen geprüft.
- Da sich der Außendurchmesser durch das Gewindegewinde verändern kann, ist eine Überprüfung nach der Gewindefertigstellung notwendig.
- Grundsätzlich soll vor Lehren des Außengewinde-Flankendurchmessers eine Lehren oder Prüfung des Außengewinde-Außendurchmessers erfolgen.
- Der glatte Gutlehring für den Außengewinde-Außendurchmesser muss sich über die ganze Gewindelänge ohne Anwendung besonderer Kraft schieben lassen.
- Der glatte Ausschusslehring für den Außengewinde-Außendurchmesser darf sich nicht mehr als zwei Gewindegänge ($2 \times P$), vom Gewindeanfang aus, über das Werkstückgewinde schieben lassen.

Gauges for external thread major diameters

- The external thread major diameter is tested with smooth go and no-go ring gauges.
- As the major diameter can change through thread cutting, an inspection is required after the thread has been completed.
- Generally speaking, a check of the external thread major diameter should be made before gauging the external thread pitch diameter.
- It must be possible to push the smooth go ring gauge for the external thread major diameter along the entire thread length without the use of particular force.
- It must not be possible to push the smooth no-go ring gauge for the external thread major diameter over the workpiece thread by more than two pitches ($2 \times P$) from the start of the thread.

Product Finder

M

MF

UNC

UNF

G

Rp
R, Rc

NPT, NPTF

BSW

Pg

MJ
UNJC, UNJFEG (STI)
SELF-LOCKTr, Tr-F
RdGlatt
Smooth

GT, TD

Zubehör
AccessoriesKalibrieren
Calibration

Tech. Info



- Product Finder
- M
- MF
- UNC
- UNF
- G
- Rp
R, Rc
- NPT, NPTF
- BSW
- Pg
- MJ
UNJC, UNJF
- EG (STI)
SELF-LOCK
- Tr, Tr-F
Rd
- Glatt
Smooth
- GT, TD
- Zubehör
Accessories
- Kalibrieren
Calibration
- Tech. Info

6.6 Gewinde-Tiefenlehndorne

Einleitung

Die EMUGE Gewindetiefen-Lehrdorne ermöglichen die Gewindelehre und das Messen der Gewindetiefe in einem Arbeitgang. Ihr Einsatzgebiet finden diese Lehrdorne bei Bauteilen mit gleicher Gewindeabmessung und unterschiedlichen Gewindetiefen, sowie der Einstellung der Gewindetiefe bei allen Arten der Innengewinde-Herstellung.

Bei dem **GT-GR-LD (Gewindetiefen-Grenz-Lehrdorn)** handelt es sich um eine Handlehre, mit der das Gewinde gelehrt und die Gewindetiefe in einem Vorgang gemessen werden kann.

Bei dem **TD-Bit-GUT (Thread Depth-Bit-GUT-Lehrdorn)** handelt es sich um eine Maschinenlehre mit Bit-Aufnahme (DIN ISO 1173), die in einem Akku-Schrauber, Druckluftschrauber oder einer Bohrmaschine verwendet wird, um das Gewinde und die Gewindetiefe in einem Vorgang zu prüfen.

Durch das Einschieben der angefederten Skalenhülle lässt sich die volle geschnittene Gewindetiefe schnell und exakt ablesen.

Die Gewindetiefen-Lehrdorne **GT-GR-LD** und **TD-Bit-GUT** sind sowohl in analoger als auch in digitaler Ausführung verfügbar und erfüllen die gleichen Festlegungen und Prüfkriterien wie in DIN ISO 1502 für Gewinde-Lehrdorne festgelegt.



6.6 GT thread depth plug gauges

Introduction

The thread depth plug gauges permit gauging and measuring of threads in one single step.

These gauges are used in components with identical thread dimensions but different thread depths as well as for setting up a thread depth for any kind of internal thread production.

The **GT-GR-LD** is a manually operated gauge for gauging threads and their depths in one single step.





The **TD-Bit-GUT** is an automatically operated gauge with bit holder (DIN ISO 1173) for use on cordless or pressurised air screwdrivers or drill machines in order to check any thread and its depth in one single step.

By pushing the spring-loaded scaled sleeve into the handle, the fully cut thread depth can be read off quickly and precisely from the display. The thread depth plug gauges **GT-GR-LD** and **TD-BIT-GUT** are available both in analogue and digital versions and comply with the DIN ISO 1502 criteria defined for thread plug gauges.



6.6 Gewinde-Tiefenlehrdorne

6.6 GT thread depth plug gauges

	„analog“	„digital IW“
	Analoge Ausführung Analogue version	Digitale Ausführung Digital version
GT-GR-LD Handlehren Manually operated gauges	 4 x D	 2,5 x D
TD-Bit-GUT Maschinenlehren Automatically operated gauges	 2,5 x D	 2,5 x D

Merkmale

- Reduziert den Prüfaufwand um ca. 50%
- In verschiedenen Größen verfügbar
- Leicht einstellbar
- Universell einsetzbar
- Lehrenkörper auf Wunsch auch beschichtet
- Messgenauigkeit analog 0,5 mm / digital 0,01 mm
- Mit Feststellschraube zur Fixierung der Skalenhülse optional lieferbar
- Einfacher und sicherer Einsatz
- Digitale Ausführung mit Funkschnittstelle für PC-Auswertung (bei Auslieferung deaktiviert)
- Handlehren optional mit „Gefühlsratsche“ erhältlich

Notable Features

- Reduction of the gauging time by approx. 50%
- Available in various sizes
- Easily adjustable
- Universally applicable
- Gauges can be coated on demand
- Dimension accuracy analogue 0.5 mm / digital 0.01 mm
- Set screw for fixing the scaled sleeve included on request
- Easy and safe performance
- Digital version with wireless interface for PC evaluation (deactivated in default factory setting)
- Manually operated gauges available on request with torque limiter

Product
Finder

M

MF

UNC

UNF

G

Rp
R, Rc

NPT, NPTF

BSW

Pg

MJ
UNJC, UNJFEG (STI)
SELF-LOCKTr, Tr-F
RdGlatt
Smooth

GT, TD

Zubehör
AccessoriesKalibrieren
Calibration

Tech. Info



- Product Finder
- M
- MF
- UNC
- UNF
- G
- Rp R, Rc
- NPT, NPTF
- BSW
- Pg
- MJ UNJC, UNJF
- EG (STI) SELF-LOCK
- Tr, Tr-F Rd
- Glatt Smooth
- GT, TD
- Zubehör Accessories
- Kalibrieren Calibration
- Tech. Info

6.6 Gewinde-Tiefenlehrdorne

Der **Gewindetiefen-Lehrdorn „analog“** wird auf das zu prüfende Innengewinde aufgesetzt und bis zum Gewindegrund eingeschraubt. Die dadurch erreichte Gewindetiefe kann am Übergang der Skalenhülse zum Griff an der Tiefenskala mit einer Genauigkeit von 0,5 mm abgelesen werden.

GT-GR-LD „analog“



4 x D

Handlehre

Der **GT-GR-LD „analog“** ermöglicht das Lehren von Gewinden und das gleichzeitige Messen der Gewindetiefe von Hand. Zur Feinjustierung der Gewinde-Messtiefe kann die Handlehre optional auch mit einer Gefühlsratsche ausgeführt werden. Diese ermöglicht ein gleichbleibendes Einschraubmoment und dient nicht zur Drehmomentübertragung.

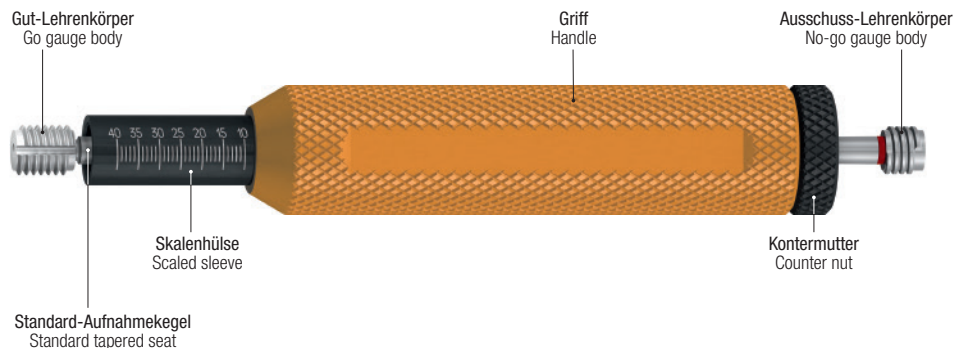

Manually operated gauges

GT-GR-LD „analog“ for manually gauging threads and their depths simultaneously. Manually operated gauges can be fitted with a torque limiter on request for fine-adjustment of measuring depth of the thread. It allows to maintain a consistent screw-in torque but does not serve to transmit torque.

TD-Bit-GUT „analog“



2,5 x D

Maschinenlehre

Der **TD-Bit-GUT „analog“** – in Kombination mit einer Antriebseinheit (z.B. Akkuschauber, Druckluftschrauber oder Bohrmaschine) – ermöglicht im Vergleich zur Handlehre eine erheblich kürzere Prüfdauer und ein ermüdungsfreies Arbeiten im Dauerbetrieb. Durch die Schnittstelle mittels eines Außensechskants 1/4" nach DIN ISO 1173 können mehrere „TD-Bit-GUT“ mit einer Antriebseinheit angetrieben bzw. schnell umadaptiert werden. Unabhängig vom Bediener verbessert die automatisierte Gewindeprüfung mit konstantem Drehmoment die Reproduzierbarkeit des Prüfergebnisses.

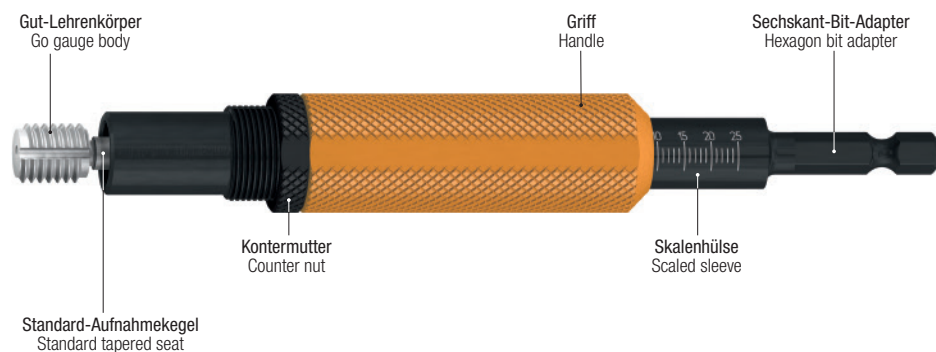

Automatically operated gauges

The **TD-Bit-GUT „analog“** used together with a drive unit (e.g. a cordless air screwdriver or drill machines) shortens gauging time and enables an effortless long-term working. Due to the DIN ISO 1173 hexagon 1/4" interface many „TD-Bit-GUT“ might be driven with one single unit and can be exchanged rapidly. Independently of the user, automatic gauging with a constant torque improves the reproducibility of the results.

6.6 Gewinde-Tiefenlehrdorne

Um die genaue Gewindetiefe zu ermitteln empfehlen wir, den **Gewindetiefen-Lehrdorn „digital IW“** bis zum Gewindegrund einzuschrauben. Die dadurch erreichte Gewindetiefe kann durch das Nullsetzen (RESET) der Anzeige und dem anschließenden Ausdrehen des **Gewindetiefen-Lehrdorns „digital IW“** aus dem Werkstück mit einer Genauigkeit von 0,01 mm abgelesen werden. Somit kann auch an verdeckten Positionen geprüft werden.

Der **Gewindetiefen-Lehrdorn „digital IW“** ermöglicht durch seine große LCD-Anzeige ein sicheres und ermüdungsfreies Ablesen der Messwerte. Optional besteht die Möglichkeit, die Messwerte per Funk auf einen PC zu übertragen. Die Datenübertragung erfolgt kabellos vom Lehrdorn zum Empfänger i-Stick, der sich im USB-Port des PC befindetet.

Die Option „Integrated Wireless“ (IW) ermöglicht eine einfache und sichere Datenübertragung per Funk und die direkte Messwertübernahme in Microsoft® Excel® oder andere Microsoft® Windows®-Anwendungen, sowie eine Rückbestätigung in der LCD-Anzeige. Die Option IW ist im Auslieferungszustand nicht aktiviert. Die Aktivierung kann mittels der im Lieferumfang enthaltenen Bedienungsanleitung vorgenommen werden.

GT-GR-LD „digital IW“



2,5 x D

Handlehre

Der **GT-GR-LD „digital IW“** ermöglicht das Lehren von Gewinden und das gleichzeitige Messen der Gewindetiefe von Hand.

Zur Feinjustierung der Gewinde-Messtiefe kann die Handlehre optional auch mit einer Gefühlsratsche ausgeführt werden.

Diese ermöglicht ein gleichbleibendes Einschraubmoment und dient nicht zur Drehmomentübertragung.

Manually operated gauges

GT-GR-LD „digital IW“ for manually gauging threads and their depths simultaneously.

Manually operated gauges can be fitted with a torque limiter on request for fine-adjustment of measuring depth of the thread.

It allows to maintain a consistent screw-in torque but does not serve to transmit torque.

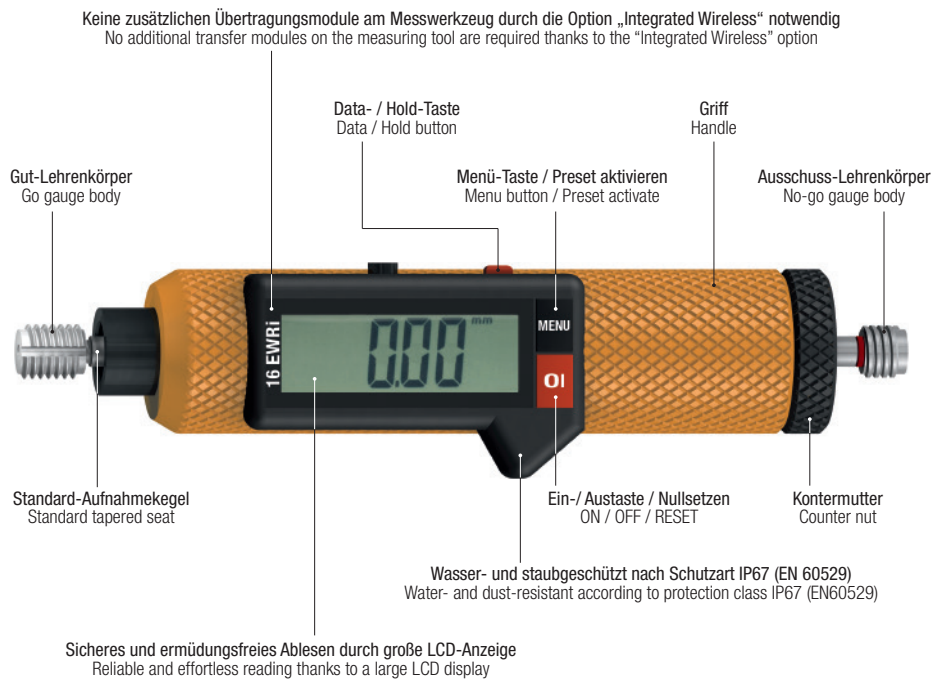

Product Finder

M

MF

UNC

UNF

G

Rp
R, Rc

NPT, NPTF

BSW

Pg

MJ
UNJC, UNJFEG (STI)
SELF-LOCKTr, Tr-F
RdGlatt
Smooth

GT, TD

Zubehör
AccessoriesKalibrieren
Calibration

Tech. Info



- Product Finder
- M
- MF
- UNC
- UNF
- G
- Rp R, Rc
- NPT, NPTF
- BSW
- Pg
- MJ UNJC, UNJF
- EG (STI) SELF-LOCK
- Tr, Tr-F Rd
- Glatt Smooth
- GT, TD
- Zubehör Accessories
- Kalibrieren Calibration
- Tech. Info

6.6 Gewinde-Tiefenlehndorne

6.6 GT thread depth plug gauges

TD-Bit-GUT „digital IW“



2,5 x D

Maschinenlehre

Der TD-Bit-GUT „digital IW“ – in Kombination mit einer Antriebseinheit (z.B. Akkuschauber, Druckluftschrauber oder Bohrmaschine) – ermöglicht im Vergleich zur Handlehre eine erheblich kürzere Prüfdauer und ein ermüdungsfreies Arbeiten im Dauerbetrieb. Durch die Schnittstelle mittels eines Außensechskants 1/4" nach DIN ISO 1173 können mehrere „TD-Bit-GUT“ mit einer Antriebseinheit angetrieben bzw. schnell umadaptiert werden. Unabhängig vom Bediener verbessert die automatisierte Gewindeprüfung mit konstantem Drehmoment die Reproduzierbarkeit des Prüfergebnisses.

Automatically operated gauges

The TD-Bit-GUT „digital IW“ used together with a drive unit (e.g. a cordless or pressurised air screwdriver or drill machines) shortens gauging time and enables an effortless long-term working. Due to the DIN ISO 1173 hexagon 1/4" interface many „TD-Bit-GUT“ might be driven with one single unit and can be exchanged rapidly. Independently of the user, automatic gauging with a constant torque improves the reproducibility of the results.

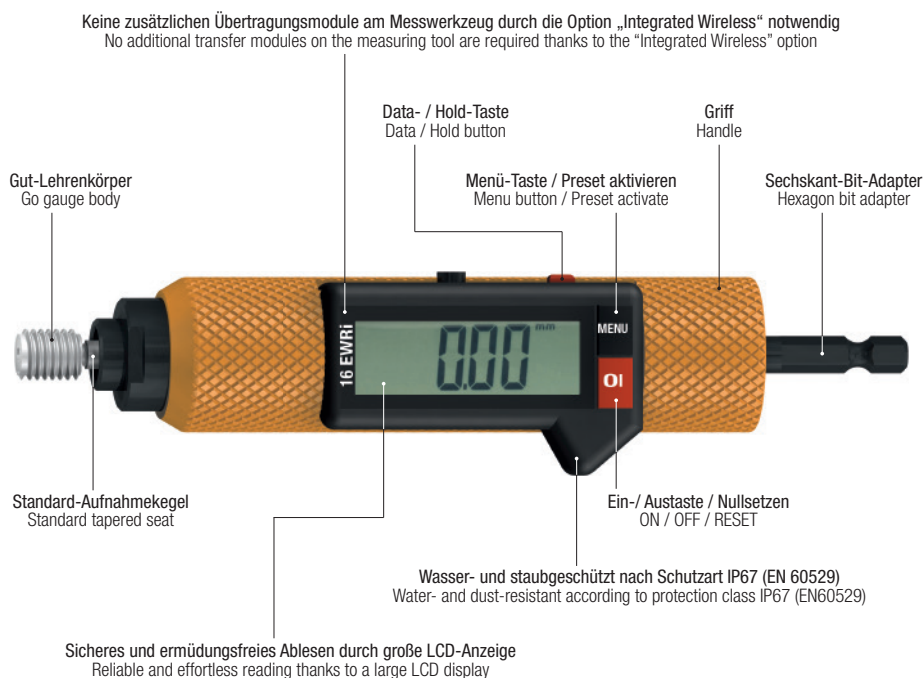

EG-Konformitätserklärung

CE-Kennzeichnung für Ausführungen „digital IW“

EMUGE erklärt, dass die bezeichneten Produkte in ihrer Konzipierung und Bauart sowie in den in Verkehr gebrachten Ausführungen den grundlegenden Sicherheits- und Gesundheitsanforderungen der EG-Richtlinie 2004/108/EG über elektromagnetische Verträglichkeit (EMV) sowie der EG-Richtlinie 2006/95/EG über Niederspannung entspricht. Bei einer mit EMUGE nicht abgestimmten Änderung der Produkte verliert diese Erklärung ihre Gültigkeit.

Hinweis:

Eine gleichlautende Erklärung für Märkte außerhalb der Europäischen Union (bzw. dem EWR) liegt EMUGE nicht vor. Der Inverkehrbringer der Produkte außerhalb der EU übernimmt die Verantwortung für den Einsatz gemäß der im Drittland geltenden Gesetzesvorgaben selbst.

EC Declaration of Conformity

CE marking for designs "digital IW"

EMUGE declares, that the described products, based on their conceptual design and version placed on the market complies with the essential Safety and Health Regulations according to Directive 2004/108/EC concerning Electromagnetic Compatibility (EMC) and with the Low Voltage Directive 2006/95/EC. If any alteration is made on this products without the prior consent of EMUGE, this declaration shall cease to apply.

Remark:

An identical declaration for markets outside the European Union (resp. the European Economic Area) is not available to EMUGE. The distributor of the product outside the EU assumes sole responsibility for the use in accordance with the specific legal regulations in the third country.

6.7 Glatte Lehrdorne für Bohrungen nach DIN EN ISO 1938-1

Für die Lehrung von Passbohrungen wird der glatte Gutlehrdorn und der glatte Ausschusslehrdorn verwendet. Bis Bohrungsdurchmesser 65 mm sind Gut- und Ausschusslehrdorn auf einem Griff montiert und werden als glatter Grenzlehrdorn bezeichnet.

Glatt-GUT-LD



Glatter Gutlehrdorn

- Der glatte Gutlehrdorn prüft das Bohrungskleinmaß einschließlich gewisser Formabweichungen, z.B. Rundheit und Zylindrizität.
- Der glatte Gutlehrdorn muss sich von Hand ohne Anwendung besonderer Kraft auf die ganze Länge der Bohrung einschieben lassen.
- Um eine höhere Verschleißfestigkeit zu erreichen, empfiehlt EMUGE, den glatten Gutlehrdorn in hartverchromter Ausführung oder Hartmetall-Ausführung zu verwenden.
- Baumaße des glatten Gutlehrdornes nach DIN 2246 und DIN 2248.

Smooth go plug gauge

- The smooth go plug gauge checks the minimum drilled hole dimension including certain form deviations, e.g. circularity and cylindricity.
- It must be possible to push the smooth go plug gauge by hand into the full length of the drilled hole without the use of particular force.
- To achieve higher wear resistance, EMUGE recommends using the smooth go plug gauge in the hard-chrome-plated or carbide version.
- Dimensions of the smooth go plug gauge acc. DIN 2246 and DIN 2248.

Glatt-AUS-LD

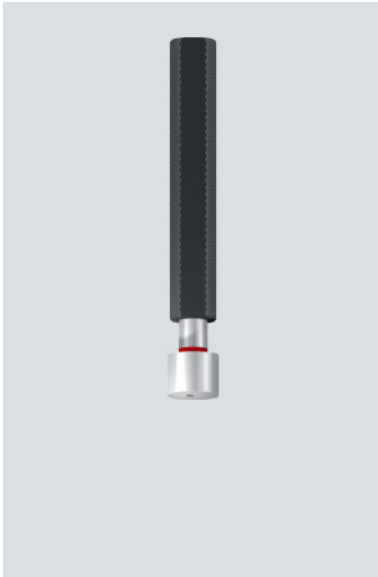

Glatter Ausschusslehrdorn

- Der glatte Ausschusslehrdorn prüft, ob der Bohrungsdurchmesser das vorgeschriebene Größtmaß überschreitet.
- Der glatte Ausschusslehrdorn darf sich von Hand ohne Anwendung besonderer Kraft nicht in die Bohrung einführen lassen.
- Der glatte Ausschusslehrdorn ist mit einem roten Farbring markiert.
- Baumaße des glatten Ausschusslehrdornes nach DIN 2247 und DIN 2249.

Smooth no-go plug gauge

- The smooth no-go plug gauge checks whether the drilled hole diameter has exceeded the prescribed maximum size.
- It must not be possible to insert the smooth no-go plug gauge into the drilled hole without the use of particular force.
- The smooth no-go plug gauge is marked with a red coloured ring.
- Dimensions of the smooth no-go plug gauge acc. DIN 2247 and DIN 2249.

Product Finder

M

MF

UNC

UNF

G

Rp
R, Rc

NPT, NPTF

BSW

Pg

MJ
UNJC, UNJFEG (STI)
SELF-LOCKTr, Tr-F
RdGlatt
Smooth

GT, TD

Zubehör
AccessoriesKalibrieren
Calibration

Tech. Info



- Product Finder
- M
- MF
- UNC
- UNF
- G
- Rp
R, Rc
- NPT, NPTF
- BSW
- Pg
- MJ
UNJC, UNJF
- EG (STI)
SELF-LOCK
- Tr, Tr-F
Rd
- Glatt
Smooth
- GT, TD
- Zubehör
Accessories
- Kalibrieren
Calibration
- Tech. Info

6.8 Glatte Lehrringe für Wellen nach DIN EN ISO 1938-1

Für die Lehrung von Wellendurchmessern, besonders für leicht verformbare Teile, wird der glatte Gutlehrring und der glatte Ausschusslehrring verwendet.

6.8 Smooth ring gauges for shafts acc. DIN EN ISO 1938-1

The smooth go ring gauge and the smooth no-go ring gauge are used for gauging shaft diameters, especially for components which are easily deformed.

Glatt-GUT-LR

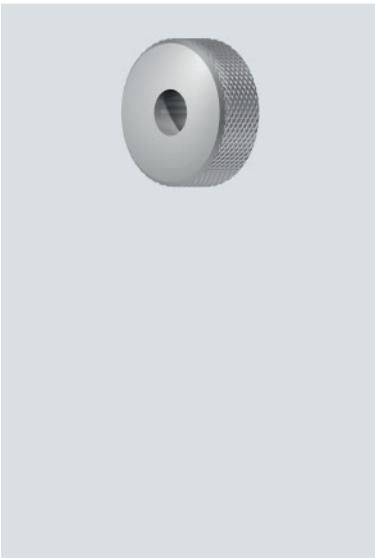

Glatter Gutlehrring

- Der glatte Gutlehrring prüft das Wellengrößtmaß einschließlich gewisser Formabweichungen, z.B. Rundlauf und Zylindrizität.
- Ein glatter, zylindrischer Gutlehrring soll über die ganze Länge mit der Welle gepaart werden können, und zwar von Hand ohne besonderen Kraftaufwand.
- Baumaße der glatten Gutlehrringe nach DIN 2250.

Smooth go ring gauge

- The smooth go ring gauge checks the maximum shaft dimension including certain form deviations, e.g. concentricity and cylindricity.
- It must be possible to pair a smooth, cylindrical go ring gauge with the shaft over the entire length by hand without particular application of force.
- Dimensions of the smooth go ring gauges acc. DIN 2250.

Glatt-AUS-LR

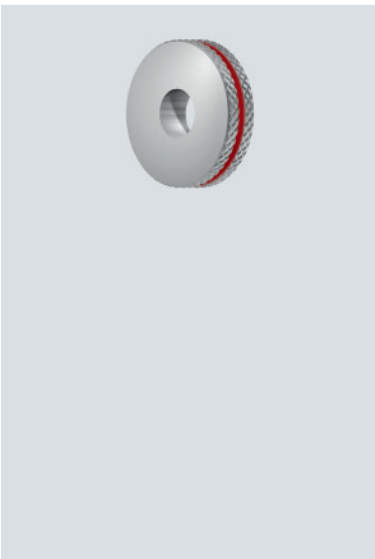

Glatter Ausschusslehrring

- Der glatte Ausschusslehrring prüft, ob die Welle das vorgeschriebene Wellenkleinstmaß unterschreitet.
- Der glatte Ausschusslehrring darf sich von Hand ohne Anwendung besonderer Kraft nicht auf die Welle aufschieben lassen.
- Baumaße der glatten Ausschusslehrringe nach DIN 2254.

Smooth no-go ring gauge

- The smooth no-go ring gauge checks whether the shaft has fallen below the prescribed minimum shaft dimension.
- It must not be possible to pair a smooth no-go ring gauge with the shaft without particular application of force.
- Dimensions of the smooth no-go ring gauges acc. DIN 2254.

Glatt-Einst-LR

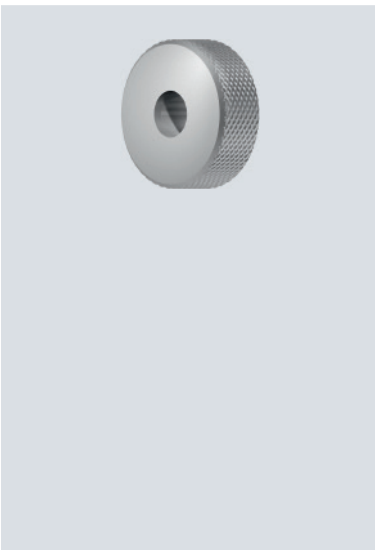

Glatte Einstellringe

Es wird unterschieden zwischen:

- Einstellringe für pneumatische Längenmessgeräte nach DIN 2250 Form B
und
- Einstellringe für Reibahlen und für allgemeine Anwendung nach DIN 2250 Form C.

Smooth adjusting rings

A differentiation is made between:

- Adjusting rings for pneumatic length measuring instruments acc. DIN 2250 Form B
and
- Adjusting rings for reamers and for general use acc. DIN 2250 Form C.

6.9 Lehrung von anderen Gewinden

Gewindelehren für andere Gewinde (Dichtgewinde, kegelige Gewinde, Festsitzgewinde, SELF-LOCK-Gewinde, u.a.) weichen oft von der allgemeinen Lehrenform erheblich ab. Sie sind meist auf die spezielle Art und Funktion dieser Gewinde abgestimmt.

Ein markantes Beispiel sind die Gewindelehren für Dichtgewinde, z.B. NPT- und NPTF-Gewinde nach US-Norm oder Rohr-Dichtgewinde nach DIN EN 10226 / ISO 7. In solchen Fällen sind die Vorschriften über die Lehrung dieser Gewinde genau zu beachten.

6.9.1 Lehrung des EMUGE-SELF-LOCK-Gewindes

Hier empfiehlt sich das zweiteilige Lehrensystem von EMUGE, das der gängigen Praxis der Gut- und Ausschusslehre entspricht und für die Gewindeprüfung ausreicht, wenn sichergestellt ist, dass das SELF-LOCK-Gewinde mit profilgetreuen EMUGE-Gewindebohrern hergestellt wurde.

Es gibt keine allgemein gültige Norm (z.B. DIN-Norm) über das EMUGE SELF-LOCK-Gewinde. Andere Werkzeughersteller könnten daher mit anderen Gewinde-Grenzmaßen arbeiten. Deshalb ist es empfehlenswert, EMUGE SELF-LOCK-Gewinde ausschließlich mit EMUGE SELF-LOCK-Gewindelehren zu prüfen.

Beim Gutlehrdorn ist auf die richtige Einschraubseite zu achten. Die Ausschussseite ist für beide Einschraubrichtungen geeignet.

Grenzlehrdorn für das EMUGE-SELF-LOCK-Gewinde

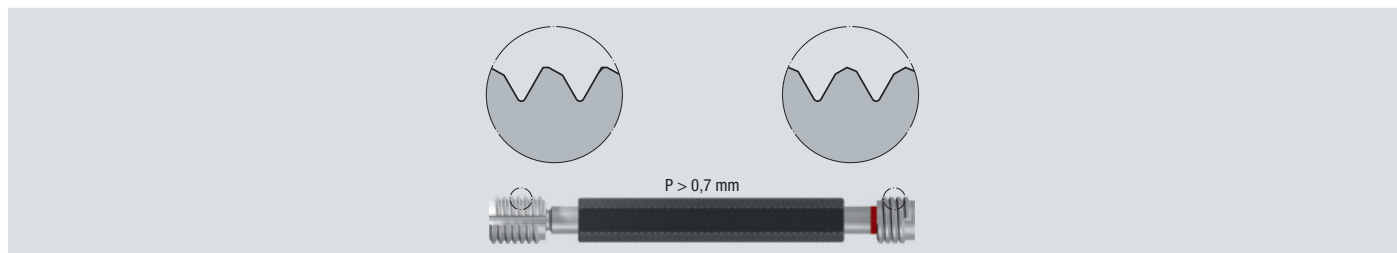

Werden Strehler oder Gewindefräser eingesetzt, ist die zusätzliche Verwendung der EMUGE-HPRG-Lehre empfehlenswert. Diese prüft den unteren Rampenpunkt, bzw. eventuelle Rampenwinkelfehler.

HPRG-Ausschusslehrdorn für das EMUGE-SELF-LOCK-Gewinde

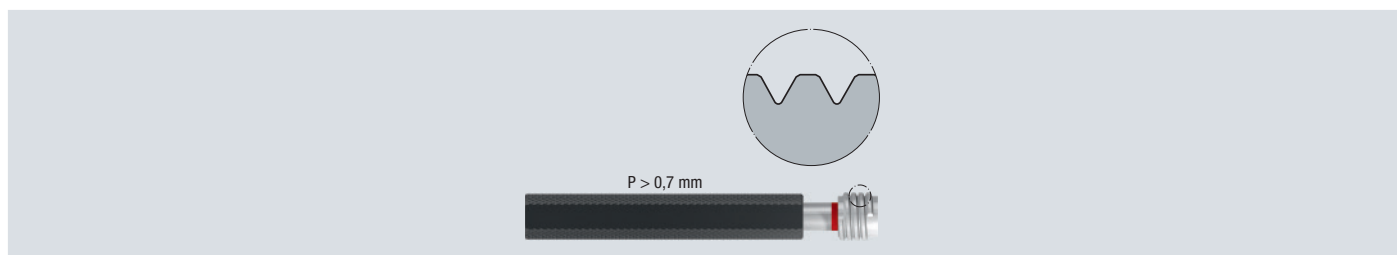

Die Lehrung des Sägezahn-Profiles beruht auf dem gleichen Prinzip, jedoch ist bei Gut- und Ausschusslehrdorn auf die richtige Einschraubseite (BT, TT) zu achten.

Grenzlehrdorn für das EMUGE-SELF-LOCK-Sägezahn-Gewinde

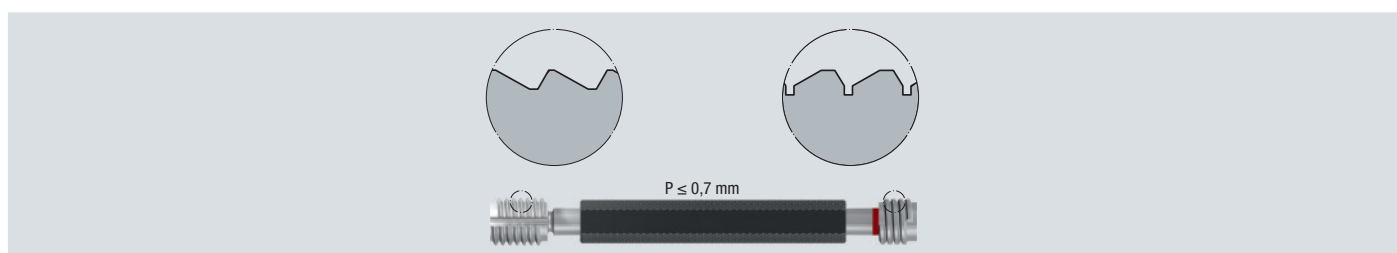

6.9 Gauging of other threads

Thread gauges for other threads (sealing threads, tapered threads, threads for tight fit, SELF-LOCK threads etc.) often deviate considerably from the normal gauge design. They are usually adjusted to the special design and function of these threads.

One good example are the thread gauges for sealing threads, e.g. NPT and NPTF threads acc. US standards, or pipe sealing threads acc. DIN EN 10226 / ISO 7. In such cases, the instructions for the gauging of these threads must be observed in every detail.

6.9.1 The gauging of the EMUGE SELF-LOCK thread

We recommend using our two-piece gauge system which corresponds to the usual combination of go and no-go gauge and is perfectly sufficient for the gauging of the thread, provided that the SELF-LOCK threads were produced with our true-to-profile EMUGE taps.

There is no generally applicable standard (e.g. DIN standard) for the EMUGE SELF-LOCK thread, so other manufacturers may use different limit sizes for their threads. For this reason, we recommend gauging EMUGE SELF-LOCK threads exclusively with EMUGE SELF-LOCK gauges.

With the go plug gauge, it is important to observe the correct screw-in direction. The no-go side can be used in either screw-in direction.

Go/no-go plug gauge for the EMUGE SELF-LOCK thread

Whenever threads are produced by chasing or thread milling, we recommend the additional use of our EMUGE HPRG gauge which checks the lower end of the ramp, and helps to identify any deviations in the angle of the ramp.

HPRG no-go plug gauge for the EMUGE SELF-LOCK thread

The gauging of the buttress profile works on the same principle, with the only difference that both the go and the no-go plug gauge have to be used in the correct direction.

Go/no-go plug gauge for the EMUGE SELF-LOCK buttress thread

Product Finder

M

MF

UNC

UNF

G

Rp
R, Rc

NPT, NPTF

BSW

Pg

MJ
UNJC, UNJFEG (STI)
SELF-LOCKTr, Tr-F
RdGlatt
Smooth

GT, TD

Zubehör
AccessoriesKalibrieren
Calibration

Tech. Info

- Product Finder
- M
- MF
- UNC
- UNF
- G
- Rp
R, Rc
- NPT, NPTF
- BSW
- Pg
- MJ
UNJC, UNJF
- EG (STI)
SELF-LOCK
- Tr, Tr-F
Rd
- Glatt
Smooth
- GT, TD
- Zubehör
Accessories
- Kalibrieren
Calibration

6.9 Lehrung von anderen Gewinden

6.9.2 Amerikanisches Rohrgewinde, Flankenwinkel 60°

6.9.2.1 Rohrgewinde für allgemeine Anwendung (mit Dichtmittel) nach ANSI/ASME B1.20.1

Übersicht: **NPT**
NPSC
NPTR
NPSM
NPSL
NPSH

Jeder Buchstabe in der Bezeichnung hat folgende Beschreibung:

N	Nationale (Amerikanische) Norm
P	Rohr
T	Kegelig
C	Verschraubung/Kupplung
S	Zylindrisch
M	Mechanisch
L	Gegenmutter
H	Schlauchkupplung
R	Geländerfittings

Das Gewindeprofil ist **symmetrisch** und **senkrecht** zur Gewindeachse!

NPT-Gewinde

- Kegeliges Innengewinde und Außengewinde
- Kegelige Lehrdorne L₁ mit 3 Messstufen (Min., Basis, Max.)
- Kegelige Lehrringe L₁ mit 3 Messstufen (Min., Basis, Max.)

NPSC-Gewinde

- Zylindrisches Innengewinde für druckfeste Verbindungen, wird mit kegeligem Außengewinde NPT und einer zusätzlichen Abdichtung verschraubt
- Kegelige Lehrdorne L₁ mit 3 Messstufen (Min., Basis, Max.)

NPTR-Gewinde

- Kegeliges Innengewinde und Außengewinde zur starren mechanischen Geländerverschraubung (ähnlich NPT)

NPSM-Gewinde

- Zylindrisches Innengewinde und Außengewinde für mechanische „Free-Fitting“-Verbindungen und Befestigungen, vorwiegend bei Verbindungen von Rohren ohne inneren Druck
- Gut- und Ausschusslehrringe und -Lehrdorne sind zylindrisch!

NPSL-Gewinde

- Zylindrisches Innengewinde und Außengewinde für mechanische „Loose-Fitting“-Verbindungen mit Gegenmutter, z.B. durch Behälterwände geführt und beidseitig mit Gegenmuttern befestigt
- Gut- und Ausschusslehrringe und -Lehrdorne sind zylindrisch!

NPSH-Gewinde

- Zylindrisches Innengewinde und Außengewinde für mechanische „Loose-Fitting“-Verbindungen für Schlauchkupplungen
- Gut- und Ausschusslehrringe und -Lehrdorne sind zylindrisch!

6.9 Gauging of other threads

6.9.2 American Pipe Thread, thread angle 60°

6.9.2.1 Pipe thread for general applications (with sealant) according to ANSI/ASME B1.20.1

Overview: **NPT**
NPSC
NPTR
NPSM
NPSL
NPSH

Each letter in the designation has the following meaning:

N	National (American) Standard
P	Pipe
T	Taper
C	Coupling
S	Straight
M	Mechanical
L	Locknut
H	Hose coupling
R	Railing fittings

The thread profile is **symmetrical** and **perpendicular** to the thread axle!

NPT thread

- Tapered internal thread and external thread
- Tapered plug gauges L₁ with 3 measuring steps (Min., Basis, Max.)
- Tapered ring gauges L₁ with 3 measuring steps (Min., Basis, Max.)

NPSC thread

- Cylindrical internal thread for pressure-tight connections, is screwed with a tapered external thread NPT and an additional sealing
- Tapered plug gauges L₁ mit 3 measuring steps (Min., Basis, Max.)

NPTR threads

- Tapered internal thread and external thread for the rigid mechanical screwing of railing fittings (similar to NPT).

NPSM thread

- Cylindrical internal and external thread for mechanical “Free-Fitting” connections and fastening primarily of pipes without internal pressure
- Ring gauges and plug gauges go and no-go are cylindrical!

NPSL thread

- Cylindrical internal and external thread for mechanical “Loose-Fitting” connections with locknut, e.g. through container walls and tightened with locknuts on both sides
- Ring gauges and plug gauges go and no-go are cylindrical!

NPSH thread

- Cylindrical internal and external thread for mechanical “Loose-Fitting” connections of hose couplings
- Ring gauges and plug gauges go and no-go are cylindrical!



6.9 Lehrung von anderen Gewinden

6.9.2.2 Rohrgewinde für trockendichtende Verbindungen (ohne Dichtmittel) nach ANSI B1.20.3

Übersicht: **NPTF**
PTF-SAE-SHORT
NPSF
NPSI

Jeder Buchstabe in der Bezeichnung hat folgende Beschreibung:

N	Nationale (Amerikanische) Norm
P	Rohr
T	Kegelig
S	Zylindrisch
F	Treibstoff/Öl
I	Mittelfein

Das Gewindeprofil ist **unsymmetrisch** und **senkrecht** zur Gewindeachse!

NPTF-Gewinde

- Kegeliges Innengewinde und Außengewinde

Lehrensyst. NPTF-1

- Kegelige Lehrdorne L₁ mit 3 Messstufen (Min., Basis, Max.)
- Kegelige Lehrdorne L₃ mit 3 Messstufen (Min., Basis, Max.)
- Kegelige Lehrringe L₁ mit 3 Messstufen (Min., Basis, Max.)
- Kegelige Lehrringe L₂ mit 3 Messstufen (Min., Basis, Max.)

Lehrensyst. NPTF-2 nach ASME B1.20.5

- Kegelige Gewinde-Lehrdorn L₁ mit 4 Messstufen
- Kegelige Gewinde-Lehrdorn L₃ mit 4 Messstufen
- Kegelige glatter Lehrdorn „Crest Check“ mit 6 Messstufen für Mutterkerndurchmesser
- Kegelige Gewinde-Lehrdorn „Root Check“, Flankenwinkel 50°, mit 6 Messstufen für Mutteraußendurchmesser
- Kegelige Gewinde-Lehrdorn L₁ mit 4 Messstufen
- Kegelige Gewinde-Lehrdorn L₂ mit 4 Messstufen
- Kegelige glatter Lehrdorn „Crest Check“ mit 6 Messstufen für Bolzenaußendurchmesser
- Kegelige Gewinde-Lehrdorn „Root Check“, Flankenwinkel 50°, mit 6 Messstufen für Bolzenkerndurchmesser

PTF-SAE-SHORT-Gewinde

- Kegeliges Innengewinde PTF-SAE-SHORT, wird gepaart mit kegeligem NPTF-Außengewinde
- Kegelige Lehrdorne L₁ mit 3 Messstufen (Min., Basis, Max.)
- Kegelige Lehrdorne L₃ mit 3 Messstufen (Min., Basis, Max.)

NPSF-Gewinde

- Zylindrisches Innengewinde, wird mit kegeligem Außengewinde NPTF verschraubt
- Kegelige Lehrdorne L₁ mit 3 Messstufen (Min., Basis, Max.)

NPSI-Gewinde

- Zylindrisches Innengewinde, wird mit kegeligem Außengewinde NPTF verschraubt
- Kegelige Lehrdorne L₁ mit 3 Messstufen (Min., Basis, Max.)

6.9 Gauging of other threads

6.9.2.2 Pipe thread for dryseal connections (without sealant) according ANSI B1.20.3

Overview: **NPTF**
PTF-SAE-SHORT
NPSF
NPSI

Each letter in the designation has the following meaning:

N	National (American) Standard
P	Pipe
T	Taper
S	Straight
F	Fuel and oil
I	Intermediate

The thread profile is **asymmetrical** and **perpendicular** to the thread axle!

NPTF thread

- Tapered internal thread and external thread

Gauge system NPTF-1

- Tapered plug gauges L₁ with 3 measuring steps (Min., Basis, Max.)
- Tapered plug gauges L₃ with 3 measuring steps (Min., Basis, Max.)
- Tapered ring gauges L₁ with 3 measuring steps (Min., Basis, Max.)
- Tapered ring gauges L₂ with 3 measuring steps (Min., Basis, Max.)

Gauge system NPTF-2 according to ASME B1.20.5

- Tapered plug gauge L₁ with 4 measuring steps
- Tapered plug gauge L₃ with 4 measuring steps
- Tapered smooth plug gauge „Crest Check“ with 6 measuring steps for minor diameter of nut
- Tapered plug gauge „Root Check“, thread angle 50°, with 6 measuring steps for major diameter of nut
- Tapered ring gauge L₁ with 4 measuring steps
- Tapered ring gauge L₂ with 4 measuring steps
- Tapered smooth ring gauge „Crest Check“ with 6 measuring steps for major diameter of bolt
- Tapered ring gauge „Root Check“, thread angle 50°, with 6 measuring steps for minor diameter of bolt

PTF-SAE-SHORT thread

- Tapered internal thread PTF-SAE-SHORT, is coupled with a tapered NPTF external thread
- Tapered plug gauges L₁ with 3 measuring steps (Min., Basis, Max.)
- Tapered plug gauges L₃ with 3 measuring steps (Min., Basis, Max.)

NPSF thread

- Cylindrical internal thread, is screwed with a tapered external thread NPTF
- Tapered plug gauges L₁ with 3 measuring steps (Min., Basis, Max.)

NPSI thread

- Cylindrical internal thread, is screwed with a tapered external thread NPTF
- Tapered plug gauges L₁ with 3 measuring steps (Min., Basis, Max.)

Product Finder

M

MF

UNC

UNF

G

Rp
R, Rc

NPT, NPTF

BSW

Pg

MJ
UNJC, UNJFEG (STI)
SELF-LOCKTr, Tr-F
RdGlatt
Smooth

GT, TD

Zubehör
AccessoriesKalibrieren
Calibration

Tech. Info



- Product Finder
- M
- MF
- UNC
- UNF
- G
- Rp
R, Rc
- NPT, NPTF
- BSW
- Pg
- MJ
UNJC, UNJF
- EG (STI)
SELF-LOCK
- Tr, Tr-F
Rd
- Glatt
Smooth
- GT, TD
- Zubehör
Accessories
- Kalibrieren
Calibration
- Tech. Info

6.9 Lehrung von anderen Gewinden

6.9.3 Whitworth-Rohrgewinde, Flankenwinkel 55°

6.9.3.1 Rohrgewinde für allgemeine Anwendung

Rp	Zylindrisches Rohr-Innengewinde (parallel)
Rc	Kegeliges Rohr-Innengewinde
R	Kegeliges Rohr-Außengewinde

Das Gewindeprofil ist **symmetrisch** mit Außen- und Kernrundung!

Die Bolzen- und Muttergewindemaße sind in mehreren nationalen und internationalen Normen festgelegt,

z.B.: **ISO 7/1**
DIN EN ISO 10226-1
DIN EN ISO 10226-2
u.s.w.

Innengewinde Rp und Rc

Die Lehrung erfolgt nach ISO 7/2 bzw. DIN EN 10226-3

- Kegelige Lehrdorne Nr. 1 mit 1 Messstufe („+“, „-“) für Standardverschraubung
- Kegelige Lehrdorne Nr. 2 mit 1 Messstufe („+“, „-“) zur Prüfung der Einschraubtiefe
- Zylindrischer Prüfring Nr. 6 ohne Messstufe zur Prüfung der Lehren Nr. 1 und Nr. 2

Kegeliges Außengewinde R

Die Lehrung erfolgt nach ISO 7/2 bzw. DIN EN 10226-3

- Zylindrischer Lehrherring Nr. 3 mit 1 Messstufe („+“, „-“)
- Kegeliger glatter Lehrherring Nr. 4 mit 1 Messstufe („+“, „-“) zur Prüfung des Bolzenaußendurchmesser
- Kegeliger Prüfdorn Nr. 5 mit 1 Messstufe zur Prüfung der Lehre Nr. 3

6.9.3.2 Whitworth-Rohrgewinde für spezielle Verschraubungen

- **DIN 3858** = kürzere Gewindelängen
- **DIN 477, DIN EN 144-1, DIN EN ISO 11363** = Gasflaschenventile

DIN 3858

Zylindrisches Innengewinde für Rohrverschraubung mit kurzer Gewindelänge, wird mit kegeligem Außengewinde verschraubt!

- Zylindrische Lehrherringe mit 1 Messstufe für **Regelausführung (Toleranzfeldlage 1)**
- Zylindrische Lehrherringe mit 1 Messstufe für **Kurzausführung (Toleranzfeldlage 2)**
- Zylindrischer Grenzlehndorn mit Gut- und Ausschusseite zur Prüfung des Rp-Innengewindes

6.9 Gauging of other threads

6.9.3. Whitworth Pipe Thread, thread angle 55°

6.9.3.1 Pipe thread for general applications

Rp	= Cylindrical internal pipe thread (parallel)
Rc	= Tapered internal pipe thread
R	= Tapered external pipe thread

The thread profile is **symmetrical** with top and bottom triangles rounded to a circular peak!

The thread dimensions of bolt and nut are specified in several national and international standards,

e.g.: **ISO 7/1**
DIN EN ISO 10226-1
DIN EN ISO 10226-2
etc.

Internal threads Rp and Rc

Gauging is done according to ISO 7/2 resp. DIN EN 10226-3

- Tapered plug gauges no. 1 with 1 measuring step („+“, „-“) for standard screw connections
- Tapered plug gauges no. 2 with 1 measuring step („+“, „-“) for checking screw-in depth
- Cylindrical check ring gauge no. 6 without measuring step for checking gauges no. 1 and no. 2

Tapered external thread R

Gauging is done according to ISO 7/2 resp. DIN EN 10226-3

- Cylindrical ring gauge no. 3 with 1 measuring step („+“, „-“)
- Tapered smooth ring gauge no. 4 with measuring step („+“, „-“) for checking the major diameter of the bolt
- Tapered plug gauge no. 5 with 1 measuring step for checking gauge no. 3

6.9.3.2 Whitworth pipe thread for special screw connections

- **DIN 3858** = shorter thread lengths
- **DIN 477, DIN EN 144-1, DIN EN ISO 11363** = gas cylinder valves

DIN 3858

Cylindrical internal thread for pipe screw connections with short thread length, is screwed with tapered external thread!

- Cylindrical ring gauge with 1 measuring step for **standard version (tolerance zone position 1)**
- Cylindrical ring gauge with 1 measuring step for **short version (tolerance zone position 2)**
- Cylindrical plug gauge go/no-go with go side and no-go side for checking the Rp internal thread

6.9 Lehrung von anderen Gewinden

DIN 477-1

In der DIN 477 sind sowohl zylindrische als auch kegelige Verschraubungen genormt. Diese werden für Gasflaschenverschraubungen, Ventile, Seitenstutzen und Zubehör verwendet.

Zylindrische Verschraubungen

- Zylindrisches Innengewinde und Außengewinde für Seitenstutzen und Zubehör

W 21,8 x 1/14, nur in DIN 477-1 genormt

- Zylindrischer Grenzlehndorn mit Gut- und Ausschusseite
- Zylindrischer Gut- und Ausschusslehrring

W 24,32 x 1/14, nur in DIN 477-1 genormt

- Zylindrischer Grenzlehndorn mit Gut- und Ausschusseite
- Zylindrischer Gut- und Ausschusslehrring

1"-8 BSW medium class, Standardabmessung nach BS 84 genormt

- Zylindrischer Grenzlehndorn mit Gut- und Ausschusseite
- Zylindrischer Gut- und Ausschusslehrring

Kegelige Verschraubungen

- Kegeliges Innengewinde und Außengewinde für Einschraubstutzen und Flaschenhals
- Kegelverhältnis 3:25, Gewindeprofil senkrecht zum Kegelmantel

17E (W 19,8 x 1/14) und 25E (W 28,8 x 1/14) in DIN EN ISO 11363-1 und -2 genormt

Einteiliges Lehrensystem

- I-1 = Glatter Grenzlehndorn kegelig für Mutter-Kerndurchmesser
- I-2 = Gewinde-Grenzlehndorn kegelig
- I-7 = Glatter Grenzlehrring kegelig für Bolzen-Außendurchmesser
- I-8 = Gewinde-Grenzlehrring kegelig

Zweiteiliges Lehrensystem

- I-3 = Glatter Grenzlehndorn kegelig für Mutter-Kerndurchmesser (kleiner Durchmesser)
- I-5 = Glatter Grenzlehndorn kegelig für Mutter-Kerndurchmesser (großer Durchmesser)
- I-4 = Gewinde-Grenzlehndorn kegelig (kleiner Durchmesser)
- I-6 = Gewinde-Grenzlehndorn kegelig (großer Durchmesser)
- I-9 = Glatter Grenzlehrring kegelig für Bolzen-Außendurchmesser (kleiner Durchmesser)
- I-11 = Glatter Grenzlehrring kegelig für Bolzen-Außendurchmesser (großer Durchmesser)
- I-10 = Gewinde-Grenzlehrring kegelig (kleiner Durchmesser)
- I-12 = Gewinde-Grenzlehrring kegelig (großer Durchmesser)

- W 31,3 x 1/14 keg.**
nur in DIN 477-1 und -7 genormt
- Lehrensystem wie 17E und 25E

6.9 Gauging of other threads

DIN 477-1

DIN 477 specifies both cylindrical and tapered screw connections. These are used in screw connections for gas cylinders, valves, spouts and accessories.

Cylindrical screw connections

- Cylindrical internal thread and external thread for spouts and accessories

W 21.8 x 1/14, only specified in DIN 477-1

- Cylindrical plug gauge go/no-go with go side and no-go side
- Cylindrical ring gauge go and no-go

W 24.32 x 1/14, only specified in DIN 477-1

- Cylindrical plug gauge go/no-go with go side and no-go side
- Cylindrical ring gauge go and no-go

1"-8 BSW medium class, standard dimension specified according to BS 84

- Cylindrical plug gauge go/no-go with go side and no-go side
- Cylindrical ring gauge go and no-go

Tapered screw connections

- Tapered internal thread and external thread for screw-in socket and bottleneck.
- Taper ratio 3:25, thread profile perpendicular to cone surface

17E (W 19.8 x 1/14) and 25E (W 28.8 x 1/14) standardised in DIN EN ISO 11363-1 und -2

One-piece gauge system

- I-1 = Smooth plug gauge go/no-go tapered for minor diameter of nut
- I-2 = Plug gauge go/no-go tapered
- I-7 = Smooth ring gauge go/no-go tapered for major diameter of bolt
- I-8 = Ring gauge go/no-go tapered

Two-piece gauge system

- I-3 = Smooth plug gauge go/no-go tapered for minor diameter of nut (small diameter)
- I-5 = Smooth plug gauge go/no-go tapered for minor diameter of nut (large diameter)
- I-4 = Plug gauge go/no-go tapered (small diameter)
- I-6 = Plug gauge go/no-go tapered (large diameter)
- I-9 = Smooth ring gauge go/no-go tapered for major diameter of bolt (small diameter)
- I-11 = Smooth ring gauge go/no-go tapered for major diameter of bolt (large diameter)
- I-10 = Ring gauge go/no-go tapered (small diameter)
- I-12 = Ring gauge go/no-go tapered (large diameter)

- W 31.3 x 1/14 tapered**
standardised only in DIN 477-1 and -7
- Gauge system like 17E and 25E

Product
Finder

M

MF

UNC

UNF

G

Rp
R, Rc

NPT, NPTF

BSW

Pg

MJ
UNJC, UNJFEG (STI)
SELF-LOCKTr, Tr-F
RdGlatt
Smooth

GT, TD

Zubehör
AccessoriesKalibrieren
Calibration

Tech. Info



- Product Finder
- M
- MF
- UNC
- UNF
- G
- Rp
R, Rc
- NPT, NPTF
- BSW
- Pg
- MJ
UNJC, UNJF
- EG (STI)
SELF-LOCK
- Tr, Tr-F
Rd
- Glatt
Smooth
- GT, TD
- Zubehör
Accessories
- Kalibrieren
Calibration
- Tech. Info

6.9 Lehrung von anderen Gewinden

6.9.4 Metrisches kegeliges Außengewinde DIN 158, Flankenwinkel 60°

Das kegelige Außengewinde wird mit einem zylindrischen Innengewinde gepaart.

Zylindrisches Innengewinde

- Das zylindrische Innengewinde nach DIN 158 ist identisch mit dem Innengewinde nach ISO 965-1, Toleranz-Klasse 4H für den Flankendurchmesser und 5H für den Kerndurchmesser
- Die Lehrung erfolgt mit Gewinde-Grenzlehrdornen mit Gut- und Ausschusseite nach DIN ISO 1502

Kegeliges Außengewinde

- Beim kegeligen Außengewinde unterscheidet man zwei Toleranzlagen: Regelausführung und Kurzausführung!

Kegeliges Außengewinde – Regelausführung

- Das kegelige Außengewinde wird gelehrt mit zylindrischem Gewinde-Grenzlehrring mit Messstufe
Beschriftungs-Beispiel: DIN158-Z-M18x1,5 keg

Kegeliges Außengewinde – Kurzausführung

- Das kegelige Außengewinde wird gelehrt mit zylindrischem Gewinde-Grenzlehrring mit Messstufe
Beschriftungs-Beispiel: DIN158-Z-M18x1,5 keg-kurz

6.9 Gauging of other threads

6.9.4 Metric tapered external thread DIN 158, thread angle 60°

The tapered external thread is coupled with a cylindrical internal thread.

Cylindrical internal thread

- The cylindrical internal thread according to DIN 158 is identical to the internal thread according to ISO 965-1, tolerance class 4H for the pitch diameter and 5H for the minor diameter
- Gauging is done with plug gauges go/no-go with go side and no-go side according to DIN ISO 1502

Tapered external thread

- Two tolerance positions can be distinguished for the tapered external thread: standard version and short version!

Tapered external thread – standard version

- The tapered external thread is gauged with a cylindrical ring gauge go/no-go with measuring step
Example for marking: DIN158-Z-M18x1.5 keg

Tapered external thread – short version

- The tapered external thread is gauged with a cylindrical ring gauge go/no-go with measuring step
Example for marking: DIN158-Z-M18x1.5 keg-kurz



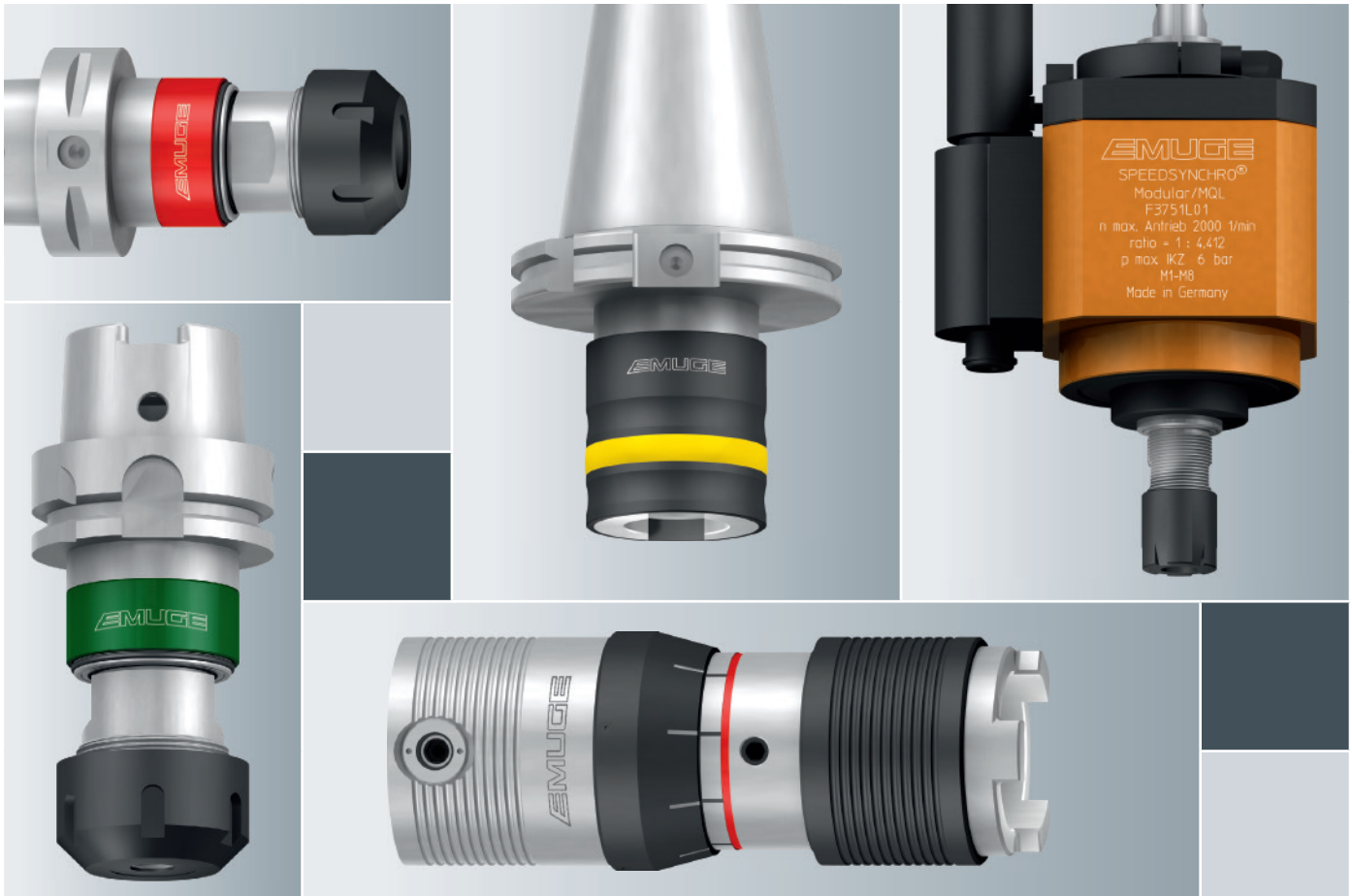

Aufnahmen und Gewindeschneidapparate Tap Holders and Tapping Attachments

Seite · Page

Übersicht

Contents

656 - 659

Produktseiten

Product pages

661 - 802

Technische Informationen









Technical information

803 - 836



- Product Finder
- Softsynchro
- Speedsynchro
- KSN
- ML MMS
- SFM
- SWITCH-MASTER
- GR, GR-S
- HF
- EM
- Zubehör Accessories
- Tech. Info

	Kühlung und Schmierung Cooling and lubrication				Funktionen Functions					
	Imere Kühlmittel-Zufuhr (IKZ) Internal coolant supply (IKZ)	Minimallängenschmierung (MMS) Minimum-quantity lubrication (MQL)	Kühlmittel-Druck am Futtereintritt Coolant-lubricant pressure at the entry to the holder	Luftdruck am Futtereintritt Air pressure at the entry to the holder	Längenausgleich in Druck- und Zugrichtung Length compensation on compression and tension	Minimallängenausgleich Minimal length compensation	Längenausgleich in Zugrichtung Length compensation on tension	Längennachstellung Length readjustment	Druckpunktmechanismus Pressure-point mechanism	Zugausrastung Front release

			p_{max} 100bar (1400psi)	p_{max} 50bar (700psi)	p_{max} 6bar (85psi)							
Softsynchro® Micro							■					
Softsynchro® 0-5	■				■		■					
Softsynchro® 6	■				■		■					
Softsynchro®/PGR	■				■		■					
Softsynchro®/Modular/IKZ	■				■		■		■			
Softsynchro®/MMS		■			■		■					
Softsynchro®/Modular/MQL		■			■		■		■			
Speedsynchro®/Modular/IKZ	■				■		■		■			
Speedsynchro®/Modular/MQL		■			■		■		■			
KSN						■				■	■	
KSN/HD	■				■	■				■	■	
KSN/HD/ER	■				■	■				■		
KSN/HD/PGR	■				■	■				■		
KSN/Synchro	■		■									
KSN/MQL		■			■	■				■	■	
SFM												
SFM-NP												■
SFM-L-DZ						■				■		
SWITCH-MASTER®	■				■			■				
GR						■						
GR-S						■						
HF						■						
HF/HD/Spezial	■				■	■						

Symbolbeschreibung der Leistungsmerkmale
Description of the symbols of performance characteristics  804 - 811

Neue EG-Maschinenrichtlinie 2006/42/EG

Mit der Neufassung der am 31. Dezember 2009 in Kraft getretenen EG-Maschinenrichtlinie 2006/42/EG werden nun auch sogenannte unvollständige Maschinen einbezogen. Dazu gehören auch Werkzeug- und Werkstückspannmittel, welche als Maschinenkomponenten in andere Maschinen eingebaut oder mit ihnen zusammengefügt werden.

Auf manuals.emugedownloads.com stellen wir Ihnen alle notwendigen Informationen der EG-Maschinenrichtlinie 2006/42/EG für unsere Produkte zur Verfügung.

New EC Machinery Directive 2006/42/EC

The new version of the EC Machinery Directive 2006/42/EC which became effective on 31 December 2009 now also contains requirements for so-called incomplete machines. This includes also tool and workpiece clamping devices which are installed into other machines as machine components, or assembled into a unit with them.

On manuals.emugedownloads.com we have compiled for you all the information from the EC Machinery Directive 2006/42/EC which may be necessary for the use of our products.

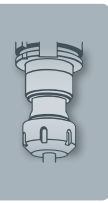

Funktionen Functions				Werkzeug-Adaptierung Tool adaptation					Empfohlene Einsatzgebiete Recommended range of application					
Übersetzung ins Schnelle Transmission gearing rapid traverse	Wendegetriebe Reverse gear	Überlastkupplung Overload clutch	Bohren und Senken Drilling and countersinking	Werkzeugadaptierung über Schnellwechsel-Einsätze, Typenreihe EM Tool adaptation by means of quick-change adapters, EM series	Werkzeugadaptierung über Schnellwechsel-Einsätze, Typenreihe HE Tool adaptation by means of quick-change adapters, HE series	Werkzeugadaptierung über Spannzangen, Typ ER (GB) Tool adaptation by means of collets, type ER (GB)	Werkzeugadaptierung über Spannzangen, Typ PGR-GB Tool adaptation by means of collets, type PGR-GB	Werkzeugadaptierung über Spannzangen, Typ Rubber-Flex Tool adaptation by means of collets, type Rubber-Flex	Einsatz auf Maschinen mit Synchronspindel For use on machines with synchronous spindle	Einsatz auf CNC-Bearbeitungszentren und sonstigen Werkzeugmaschinen For use on CNC machining centres and other machine tools	Einsatz auf Mehrspindelmaschinen und Transferstraßen For use on multi-spindle machines and transfer lines	Einsatz auf Säulenbohrmaschinen For use on pillar drilling machines		
														Softsynchro® Micro
														Softsynchro® 0-5
														Softsynchro® 6
														Softsynchro®/PGR
														Softsynchro®/Modular/IKZ
														Softsynchro®/MMS
														Softsynchro®/Modular/MQL
■														Speedsynchro®/Modular/IKZ
■														Speedsynchro®/Modular/MQL
														KSN
														KSN/HD
														KSN/HD/ER
														KSN/HD/PGR
														KSN/Synchro
														KSN/MQL
														SFM
														SFM-NP
														SFM-L-DZ
	■													SWITCH-MASTER®
	■	■												GR
	■	■												GR-S
		■	■											HF
														HF/HD/Spezial

- Product Finder
- Softsynchro
- Speedsynchro
- KSN
- MQL MMS
- SFM
- SWITCH-MASTER
- GR, GR-S
- HF
- EM
- Zubehör Accessories
- Tech. Info

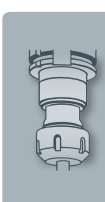

- Product Finder
- Softsynchro
- Speedsynchro
- KSN
- MQL MMS
- SFM
- SWITCH-MASTER
- GR, GR-S
- HF
- EM
- Zubehör Accessories
- Tech. Info

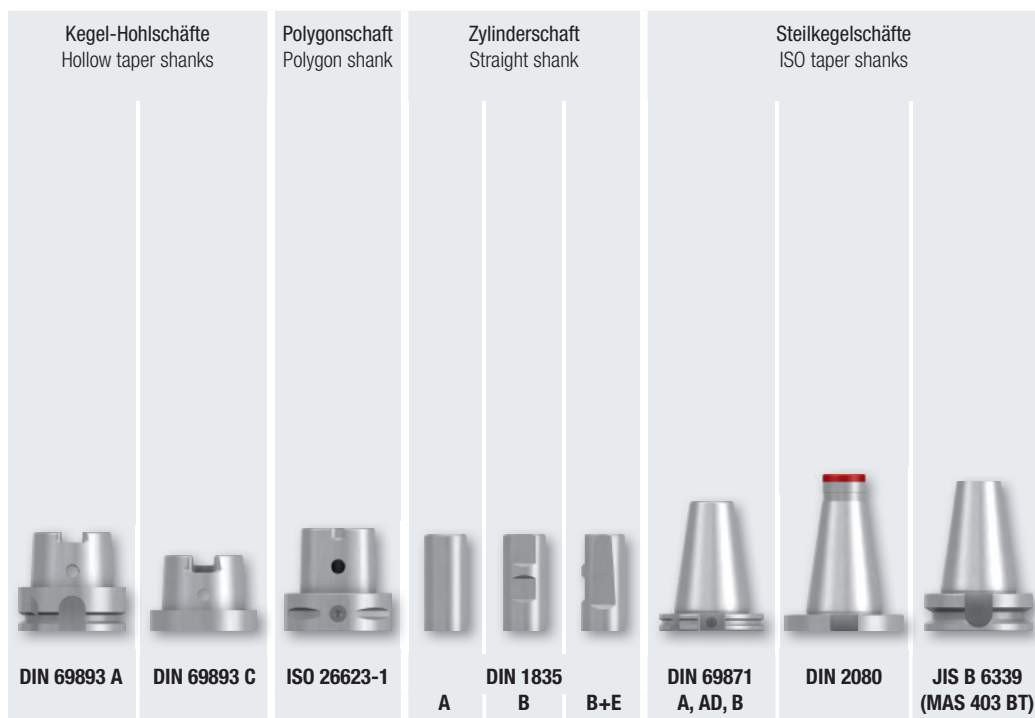

Seite · Page

Softsynchro® Micro	662			672, 673	670			
Softsynchro® 0-5	663 - 664, 666	668	669		671	674 - 675		
Softsynchro® 6	665					676		
Softsynchro®/Modular/IKZ	667							
Softsynchro®/PGR	680				681			
Softsynchro®/MMS	716 - 717	718						
Softsynchro®/Modular/MQL	720 - 723	724 - 725						
Speedsynchro®/Modular/IKZ				684				
Speedsynchro®/Modular/MQL								
KSN	688	689			690	691	692	693
KSN/HD	698	699	700		701	702		
KSN/HD/ER	706	707			708			
KSN/HD/PGR	709				710			
KSN/Synchro	711				712	713		
KSN/MQL	727 - 728	729						
SFM								
SFM-NP								
SFM-L-DZ								
HF						748 - 749	748 - 749	748 - 749
HF/HD/Spezial						750		751

Weitere Schaftvarianten auf Anfrage
Further shank types upon request

Seite · Page









Gewindeschneidapparate Typ SWITCH-MASTER®
Tapping attachments type SWITCH-MASTER®

739 - 742



Gewindeschneidapparate Typ GR und GR-S
Tapping attachments type GR and GR-S

743 - 746

Morsekegelschaft Morse taper shank	StellhülSENSchaft Cylindrical shank	VDI-Schaft VDI shank	ABS®-Kupplung ABS®-clutch	Schäfte für angetriebene Werkzeuge Shanks for driven tools		
						
DIN 228 B	DIN 6327	DIN ISO 10889 (VDI 3425)	ABS® (System KOMET)	mimatic®	heimatec®	W&F

- Product Finder
- Softsynchro
- Speedsynchro
- KSN
- MQL MMS
- SFM
- SWITCH-MASTER
- GR, GR-S
- HF
- EM
- Zubehör Accessories
- Tech. Info

Seite · Page

							Softsynchro® Micro
				677	678	679	Softsynchro® 0-5
							Softsynchro® 6
							Softsynchro®/Modular/IKZ
							Softsynchro®/PGR
							Softsynchro®/MMS
							Softsynchro®/Modular/MQL
			685				Speedsynchro®/Modular/IKZ
			686, 726				Speedsynchro®/Modular/MQL
694	695	696	697				KSN
	703	704	705				KSN/HD
							KSN/HD/ER
							KSN/HD/PGR
							KSN/Synchro
							KSN/MQL
734	735						SFM
	736						SFM-NP
737	738						SFM-L-DZ
748 - 749							HF
							HF/HD/Spezial

Seite · Page

	Schnellwechsel-Einsätze Typenreihe EM Quick-change adapters type EM	755 - 778
	Zubehör für Aufnahmen und Gewindeschneidapparate Accessories for tap holders and tapping attachments	779 - 802

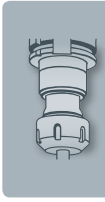

- Product Finder
- Soft-synchro
- Speed-synchro
- KSN
- MQL MMS
- SFM
- SWITCH-MASTER
- GR, GR-S
- HF
- EM
- Zubehör Accessories
- Tech. Info

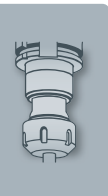

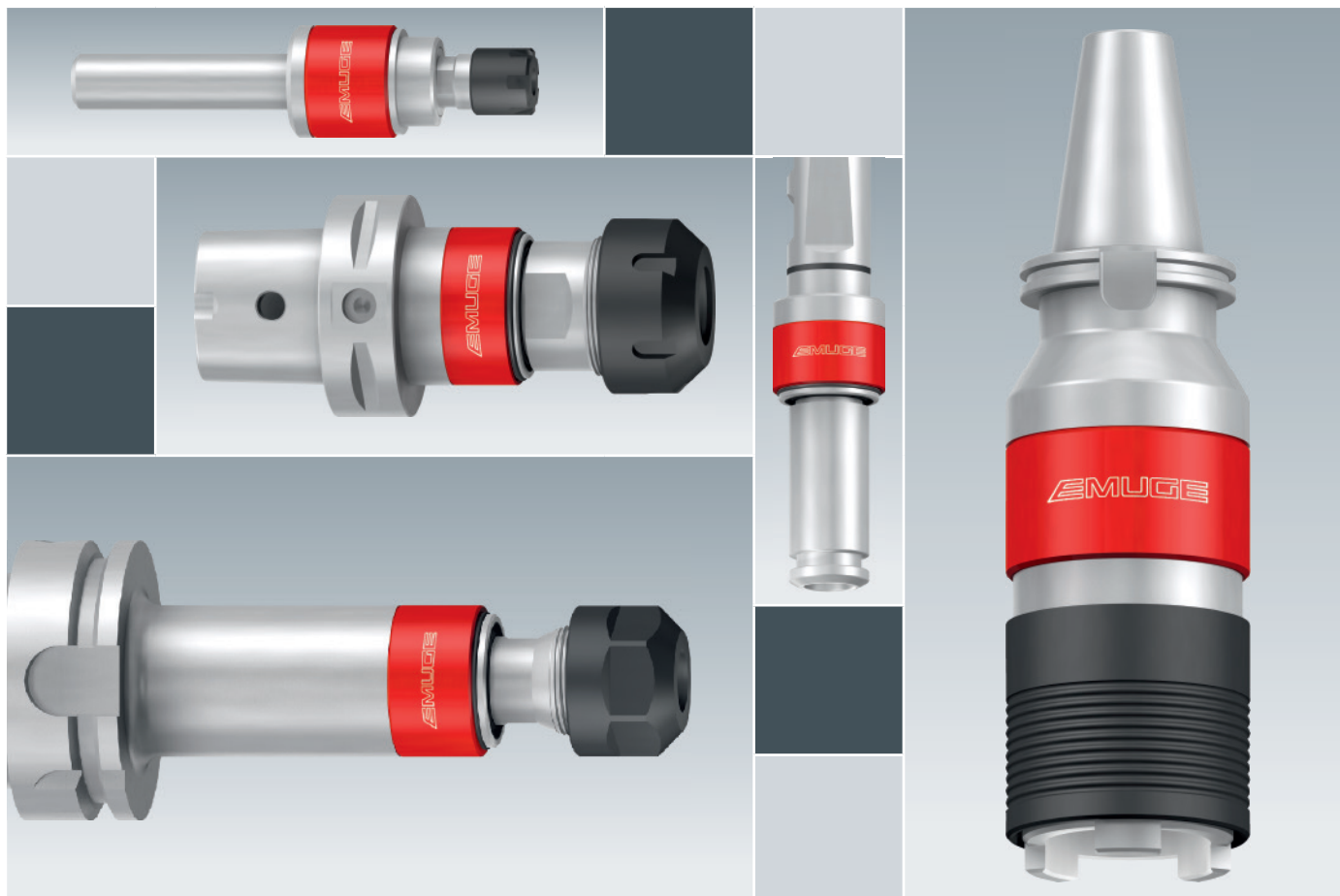

Typenreihe Softsynchro® Softsynchro® Series

Einsatz auf Maschinen mit Synchronspindel

Das Gewindewerkzeug wird durch die Synchronspindel steigungsgeführt, eventuell auftretende Axialkräfte durch Synchronisationsfehler werden durch einen patentierten Minimallängenausgleich auf Zug und Druck minimiert.

Application on machines with synchronous spindle

The threading tool is pitch-controlled by the synchronous spindle; eventually arising axial forces caused by synchronisation faults are minimised by a patent-protected minimum length compensation on tension and on compression.



Softsynchro®

DIN 69893 A

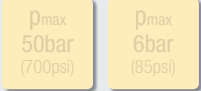

Mit Bohrung für Datenträger DIN 69873
With bore for data chip according to DIN 69873

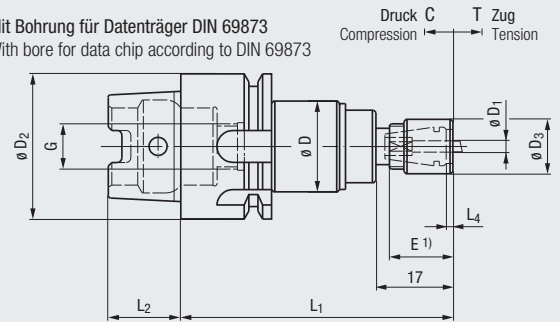

Einsatz auf Maschinen mit Synchronspindel For use on machines with synchronous spindle

Typ Type		$\varnothing D_1$			$\varnothing D_2$	$\varnothing D$	$\varnothing D_3$	L_1	L_2	L_4	G	C	T	Artikel-Nr. Article no.	
Softsynchro® Micro	M0,5 - M4 (Nr.0 - Nr.8)	2 - 4,5	ER 8	Hi-Q/ERM 8	HSK-A32	20	12	60	16	1,5	M10 x 1	0,2	0,2	F3150C01	○

1) Einstecktiefen E siehe Seite 797
Clamping depths E, see page 797

Weitere Ausführungen auf Anfrage
Further designs upon request

Spannmutter ohne integrierte Abdichtung ist im Lieferumfang enthalten
Clamping nut without integrated seal is included in the delivery

Zubehör Accessories



Spannzangen Typ ER (GB)
Collets type ER (GB)

» 786 - 787



Spannschlüsselsatz
Set of clamping wrenches

» 793



Kühlschmierstoffrohre und Schlüssel
Coolant tubes and wrenches

» 782 - 783



Drehmomentschlüssel TORCO-FIX
Torque wrenches TORCO-FIX

» 795



Detaillierte Informationen zur
synchronen Gewindeherstellung
siehe Seite 814 - 820

Detailed information
regarding rigid tapping
see page 814 - 820

Softsynchro®

DIN 69893 A

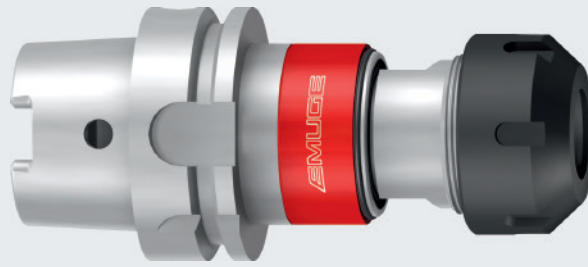

Mit Bohrung für Datenträger DIN 69873
With bore for data chip according to DIN 69873

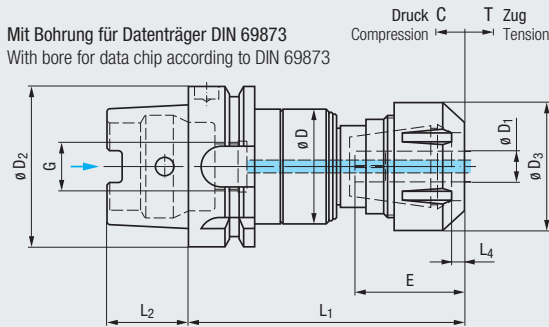

p_{max}
50bar
(700psi)

p_{max}
6bar
(85psi)

Einsatz auf Maschinen mit Synchronspindel For use on machines with synchronous spindle

Typ Type		$\varnothing D_1$			$\varnothing D_2$	$\varnothing D$	$\varnothing D_3$	L_1 ER	L_1 ER-GB	L_2	L_4	G	C	T	Artikel-Nr. Article no.	
Softsynchro® 0	M2 - M8 (Nr.2 - 5/16)	2,5 - 7	ER 11 (GB)	Hi-Q/ERM 11	HSK-A40	34	16	89,2	87,5	20	0,9	M12 x 1	0,5	0,5	F3150C02.1	●
					HSK-A50	34	16	93,2	91,5	25	0,9	M16 x 1	0,5	0,5	F3150C03.1	○
					HSK-A63	34	16	95,2	93,5	32	0,9	M18 x 1	0,5	0,5	F3150C04.1	●
					HSK-A80	34	16	99,7	98	40	0,9	M20 x 1,5	0,5	0,5	F3150C05.1	○
					HSK-A100	34	16	101,7	100	50	0,9	M24 x 1,5	0,5	0,5	F3150C06.1	○
Softsynchro® 1	M4 - M12 (Nr.8 - 7/16)	4,5 - 10	ER 20 (GB)	Hi-Q/ERC 20	HSK-A40	34	34	-	89,5	20	5	M12 x 1	0,5	0,5	F3151C02.1	●
					HSK-A50	34	34	-	93,5	25	5	M16 x 1	0,5	0,5	F3151C03.1	●
					HSK-A63	34	34	-	95,5	32	5	M18 x 1	0,5	0,5	F3151C04.1	●
					HSK-A80	34	34	-	100	40	5	M20 x 1,5	0,5	0,5	F3151C05.1	●
					HSK-A100	34	34	-	102	50	5	M24 x 1,5	0,5	0,5	F3151C06.1	●
Softsynchro® 3	M4 - M20 (Nr.8 - 3/4)	4,5 - 16	ER 32 (GB)	Hi-Q/ERC 32	HSK-A50	45	50	-	116,3	25	5	M16 x 1	0,5	0,5	F3153C03.1	●
					HSK-A63	45	50	-	108,8	32	5	M18 x 1	0,5	0,5	F3153C04.1	●
					HSK-A80	45	50	-	113,3	40	5	M20 x 1,5	0,5	0,5	F3153C05.1	●
					HSK-A100	45	50	-	115,3	50	5	M24 x 1,5	0,5	0,5	F3153C06.1	●
Softsynchro® 4	M12 - M30 (7/16 - 1 1/8)	9 - 22	ER 40 (GB)	Hi-Q/ERC 40	HSK-A63	63	63	-	146,5	32	5	M18 x 1	0,7	0,7	F3154C04.1	●
					HSK-A80	63	63	-	136	40	5	M20 x 1,5	0,7	0,7	F3154C05.1	●
					HSK-A100	63	63	-	138	50	5	M24 x 1,5	0,7	0,7	F3154C06.1	●

1) Einstecktiefen E siehe Seite 797
Clamping depths E, see page 797

Weitere Ausführungen auf Anfrage
Further designs upon request

Softsynchro® 0

Spannmutter ohne integrierte Abdichtung ist im Lieferumfang enthalten
Clamping nut without integrated seal is included in the delivery

Softsynchro® 1-4

Spannmutter für Dichtscheiben ist im Lieferumfang enthalten
Clamping nut for sealing disks is included in the delivery

Zubehör

Accessories



Spannzangen Typ ER (GB)
Collets type ER (GB)

» 786 - 787



Dichtscheiben Typ DS/ER
Sealing disks type DS/ER

» 789



Spannmutter mit integrierter
Abdichtung Typ Hi-Q/ERM 11
Clamping nut with integrated seal,
type Hi-Q/ERM 11

» 790



Spannschlüsselsatz
Set of clamping wrenches

» 793



Montagevorrichtung
Assembly device

» 793



Kühlschmierstoffrohre und Schlüssel
Coolant tubes and wrenches

» 782 - 783



Drehmomentschlüssel TORCO-FIX
Torque wrenches TORCO-FIX

» 795



Softsynchro®

DIN 69893 A



Mit Bohrung für Datenträger DIN 69873
With bore for data chip according to DIN 69873

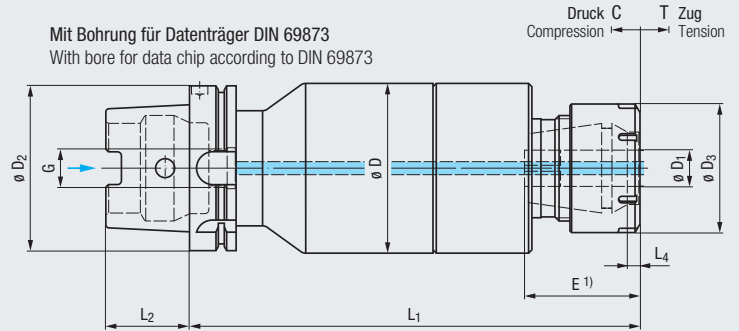

Einsatz auf Maschinen mit Synchronspindel For use on machines with synchronous spindle

Typ Type		$\varnothing D_1$			$\varnothing D_2$	$\varnothing D$	$\varnothing D_3$	L_1 ER	L_1 ER-GB	L_2	L_4	G	C	T	Artikel-Nr. Article no.
Softsynchro® 5	M30 - M48 (1 1/8 - 1 3/4)	22 - 36	ER 50 (GB)	Hi-Q/ERBC 50	HSK-A100	103	78	269	265,6	50	8	M24 x 1,5	2	2	F3155C06.1

¹⁾ Einstecktiefen E siehe Seite 797
Clamping depths E, see page 797

Weitere Ausführungen auf Anfrage
Further designs upon request

Spannmutter für Dichtscheiben ist im Lieferumfang enthalten
Clamping nut for sealing disks is included in the delivery

Vierkantaufnahme für Werkzeuge mit Schaftdurchmesser 36 mm im Futterkörper integriert
Square seat for tools with shank diameter 36 mm is integrated in the tap holder body

Zubehör Accessories



Spannzangen Typ ER (GB)
Collets type ER (GB)

» 786 - 787



Dichtscheiben Typ DS/ER
Sealing disks type DS/ER

» 789



Spannschlüssel
Clamping wrenches

» 793



Kühlschmierstoffrohre und Schlüssel
Coolant tubes and wrenches

» 782 - 783



Drehmomentschlüssel TORCO-FIX
Torque wrenches TORCO-FIX

» 795



Softsynchro®

DIN 69893 A

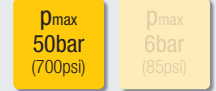

Mit Bohrung für Datenträger DIN 69873
With bore for data chip according to DIN 69873

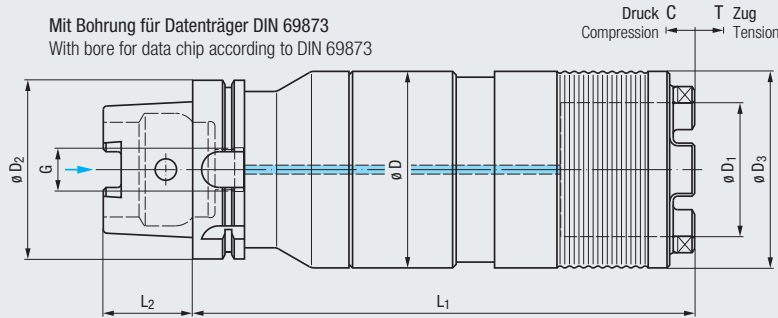

Einsatz auf Maschinen
mit Synchronspindel

For use on machines
with synchronous spindle

Typ Type			$\varnothing D_2$	$\varnothing D$	$\varnothing D_1$	$\varnothing D_3$	L_1	L_2	G	C	T	Artikel-Nr. Article no.
Softsynchro® 6	M45 - M76 (1 3/8 - 2 3/8)	HE2/IKZZ	HSK-A100	110	75	110	281	50	M24 x 1,5	2	2	F3156C06.1

Weitere Ausführungen auf Anfrage
Further designs upon request

Zubehör Accessories



Schnellwechsel-Einsätze Typ HE2/IKZZ
Quick-change adapters type HE2/IKZZ ▶ 752



Kühlschmierstoffrohre und Schlüssel
Coolant tubes and wrenches ▶ 782 - 783



Weitere Schnellwechsel-Aufnahmen
(Typenreihe HF) zur Herstellung von
großen Gewinden siehe Seite 747 - 754

Further quick-change tap holders
(HF series) for the production of
large threads, see pages 747 - 754



Softsynchro®

DIN 69893 A

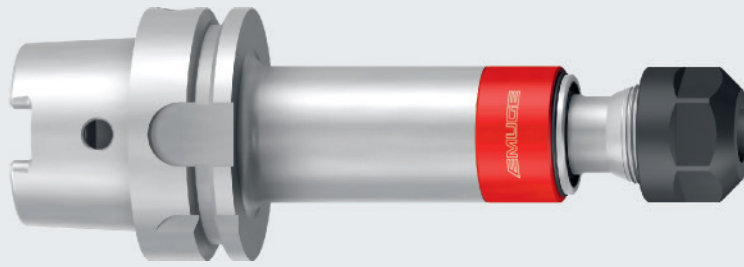

Mit Bohrung für Datenträger DIN 69873
With bore for data chip according to DIN 69873

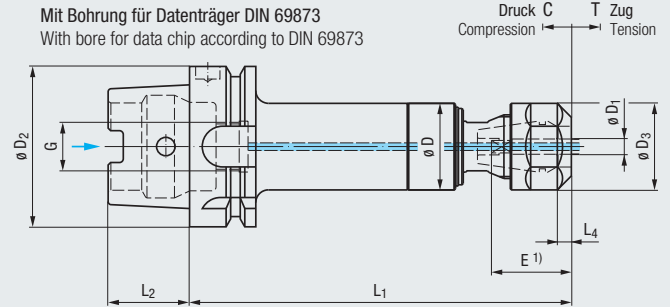

Einsatz auf Maschinen mit Synchronspindel For use on machines with synchronous spindle

Typ Type		$\varnothing D_1$			$\varnothing D_2$	$\varnothing D$	$\varnothing D_3$	L_1	L_2	L_4	G	C	T	Artikel-Nr. Article no.	
Softsynchro® 1	M4 - M12 (Nr.8 - 7/16)	4,5 - 10	ER 20 (GB)	Hi-Q/ERC 20	HSK-A63	34	34	125	32	5	M18 x 1	0,5	0,5	F3151037.1	●
					HSK-A63	34	34	150	32	5	M18 x 1	0,5	0,5	F3151918.1	●
					HSK-A63	34	34	175	32	5	M18 x 1	0,5	0,5	F3151038.1	●

1) Einsteektiefen E siehe Seite 797
Clamping depths E, see page 797

Weitere Ausführungen auf Anfrage
Further designs upon request

Spannmutter für Dichtscheiben ist im Lieferumfang enthalten
Clamping nut for sealing disks is included in the delivery

Zubehör Accessories



Spannzangen Typ ER (GB)
Collets type ER (GB)

» 786 - 787



Dichtscheiben Typ DS/ER
Sealing disks type DS/ER

» 789



Spann Schlüsselset
Set of clamping wrenches

» 793



Montagevorrichtung
Assembly device

» 793



Kühlschmierstoffrohre und Schlüssel
Coolant tubes and wrenches

» 782 - 783



Drehmomentschlüssel TORCO-FIX
Torque wrenches TORCO-FIX

» 795

Softsynchro® Modular/IKZ

DIN 69893 A

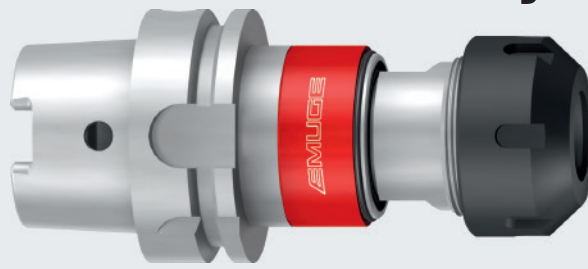

Mit Bohrung für Datenträger DIN 69873
With bore for data chip according to DIN 69873

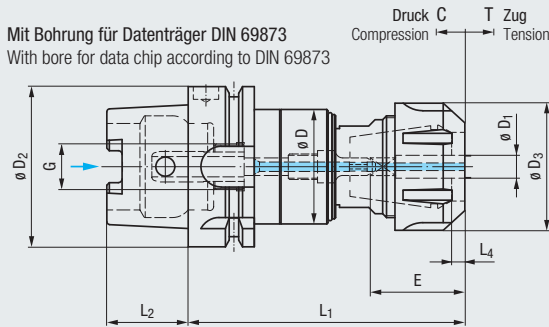

IKZ

MMS
MQL

p_{max}
50bar
(700psi)

p_{max}
6bar
(85psi)

L+ 2 mm

C T
Soft

F

↔

↔

Einsatz auf Maschinen
mit Synchronspindel

For use on machines
with synchronous spindle

new	Typ Type	$\varnothing D_1$	$\varnothing D_2$	$\varnothing D$	$\varnothing D_3$	L ₁	L ₂	L ₄	G	C	T	Artikel-Nr. Article no.			
Softsynchro® 1/Modular/IKZ	M4,5 - M10	6 / 7	ER 20 (GB)	Hi-Q/ERC 20	HSK-A40	34	34	89,5	20	5	M12 x 1	0,5	0,5	F3541C02.1.01	●
					HSK-A63	34	34	95,5	32	5	M18 x 1	0,5	0,5	F3541C04.1.01	●
					HSK-A100	34	34	102	50	5	M24 x 1,5	0,5	0,5	F3541C06.1.01	●
	M8, M9, M11, M12	8 / 9			HSK-A40	34	34	89,5	20	5	M12 x 1	0,5	0,5	F3541C02.1.02	●
					HSK-A63	34	34	95,5	32	5	M18 x 1	0,5	0,5	F3541C04.1.02	●
					HSK-A100	34	34	102	50	5	M24 x 1,5	0,5	0,5	F3541C06.1.02	●
	M10	10			HSK-A40	34	34	89,5	20	5	M12 x 1	0,5	0,5	F3541C02.1.03	●
					HSK-A63	34	34	95,5	32	5	M18 x 1	0,5	0,5	F3541C04.1.03	●
					HSK-A100	34	34	102	50	5	M24 x 1,5	0,5	0,5	F3541C06.1.03	●
Softsynchro® 3/Modular/IKZ	M12	9	ER 32 (GB)	Hi-Q/ERC 32	HSK-A63	45	50	108,8	32	5	M18 x 1	0,5	0,5	F3543C04.1.01	●
					HSK-A100	50	50	115,3	50	5	M24 x 1,5	0,5	0,5	F3543C06.1.01	●
	M10 - M16	10 - 12			HSK-A63	45	50	108,8	32	5	M18 x 1	0,5	0,5	F3543C04.1.02	●
					HSK-A100	50	50	115,3	50	5	M24 x 1,5	0,5	0,5	F3543C06.1.02	●
	M18 - M20	14 - 16			HSK-A63	45	50	108,8	32	5	M18 x 1	0,5	0,5	F3543C04.1.03	●
					HSK-A100	50	50	115,3	50	5	M24 x 1,5	0,5	0,5	F3543C06.1.03	●

Spannmutter für Dichtscheiben, Kühlschmierstoffrohr und Längeneinstellschraube sind im Lieferumfang enthalten
Clamping nut for sealing disks, coolant tube and length adjustment screw are included in the delivery

Weitere Ausführungen auf Anfrage
Further designs upon request

Einstecktiefen Clamping depths

$\varnothing D_1$	E	
	min.	max.
6	29	31
7	29	31
8	34	36
9	35	37
10	39	41
11	40	42
12	40	42
14	42	44
16	43	45

Zubehör Accessories

Spannzangen Typ ER (GB)
Collets type ER (GB)

» 786 - 787

Dichtscheiben Typ DS/ER
Sealing disks type DS/ER

» 789

Spannschlüsselsatz
Set of clamping wrenches

» 793

Montagevorrichtung
Assembly device

» 793

Längeneinstellschrauben
Length adjustment screws

» 784

Drehmomentschlüssel TORCO-FIX
Torque wrenches TORCO-FIX

» 795

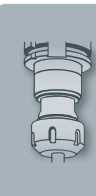

Softsynchro®

DIN 69893 C

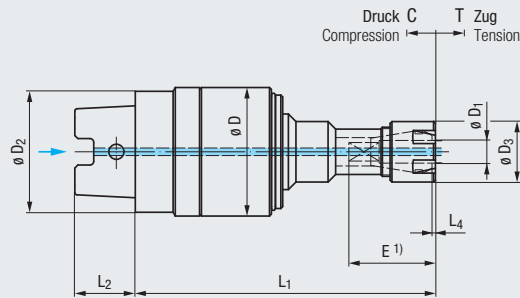
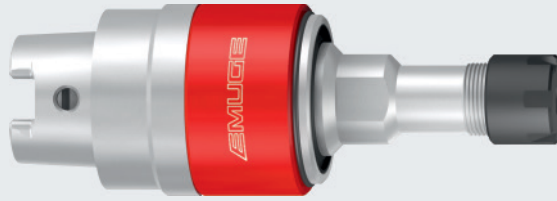

Einsatz auf Maschinen mit Synchronspindel For use on machines with synchronous spindle

Typ Type		$\varnothing D_1$			$\varnothing D_2$	$\varnothing D$	$\varnothing D_3$	L_1 ER	L_1 ER-GB	L_2	L_4	C	T	Artikel-Nr. Article no.	
Softsynchro® 0	M2 - M8 (Nr.2 - 5/16)	2,5 - 7	ER 11 (GB)	Hi-Q/ERM 11	HSK-C32	34	16	81,2	79,5	16	0,9	0,5	0,5	F3150K01.1	●
						34	16	81,2	79,5	20	0,9	0,5	0,5	F3150K02.1	○
Softsynchro® 1	M4 - M12 (Nr.8 - 7/16)	4,5 - 10	ER 20 (GB)	Hi-Q/ERC 20	HSK-C32	34	34	—	81,5	16	5	0,5	0,5	F3151K01.1	●
						34	34	—	81,5	20	5	0,5	0,5	F3151K02.1	●

¹⁾ Einstecktiefen E siehe Seite 797
Clamping depths E, see page 797

Weitere Ausführungen auf Anfrage
Further designs upon request

Softsynchro® 0

Spannmutter ohne integrierte Abdichtung ist im Lieferumfang enthalten
Clamping nut without integrated seal is included in the delivery

Softsynchro® 1

Spannmutter für Dichtscheiben ist im Lieferumfang enthalten
Clamping nut for sealing disks is included in the delivery

Zubehör Accessories



Spannzangen Typ ER (GB)
Collets type ER (GB)

» 786 - 787



Dichtscheiben Typ DS/ER
Sealing disks type DS/ER

» 789



Spannmutter mit integrierter Abdichtung Typ Hi-Q/ERM 11
Clamping nut with integrated seal, type Hi-Q/ERM 11

» 790



Spannschlüsselsatz
Set of clamping wrenches

» 793



Montagevorrichtung
Assembly device

» 793



Drehmomentschlüssel TORCO-FIX
Torque wrenches TORCO-FIX

» 795

Softsynchro®

ISO 26623-1

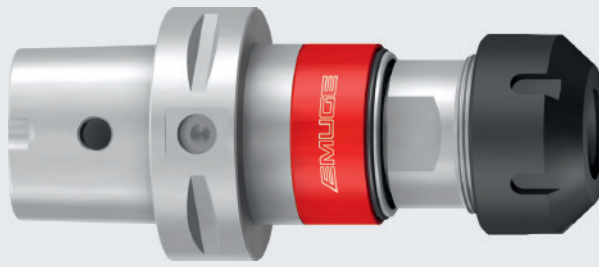

Mit Bohrung für Datenträger DIN 69873
With bore for data chip according to DIN 69873

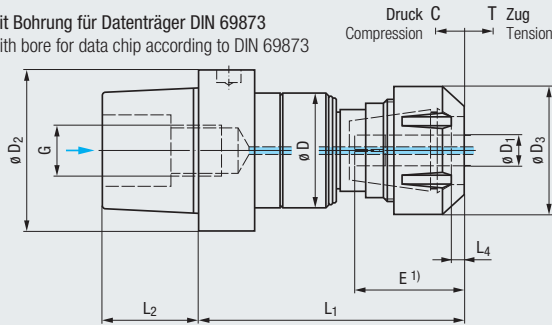

Einsatz auf Maschinen
mit Synchronspindel

For use on machines
with synchronous spindle

Typ Type		$\varnothing D_1$			$\varnothing D_2$	$\varnothing D$	$\varnothing D_3$	L_1 ER	L_1 ER-GB	L_2	L_4	G	C	T	Artikel-Nr. Article no.	
Softsynchro® 0	M2 - M8 (Nr.2 - 5/16)	2,5 - 7	ER 11 (GB)	Hi-Q/ERM 11	PSC 63	34	16	95	93,2	38	0,9	M20 x 2	0,5	0,5	F3150T06.1	●
Softsynchro® 1	M4 - M12 (Nr.8 - 7/16)	4,5 - 10	ER 20 (GB)	Hi-Q/ERC 20	PSC 40	34	34	—	89,5	24	5	M14 x 1,5	0,5	0,5	F3151T04.1	●
					PSC 50	34	34	—	89,5	30	5	M16 x 1,5	0,5	0,5	F3151T05.1	●
					PSC 63	34	34	—	93,5	38	5	M20 x 2	0,5	0,5	F3151T06.1	●
Softsynchro® 3	M4 - M20 (Nr.8 - 3/4)	4,5 - 16	ER 32 (GB)	Hi-Q/ERC 32	PSC 40	45	50	—	104	24	5	M14 x 1,5	0,5	0,5	F3153T04.1	●
					PSC 50	45	50	—	103	30	5	M16 x 1,5	0,5	0,5	F3153T05.1	●
					PSC 63	45	50	—	107	38	5	M20 x 2	0,5	0,5	F3153T06.1	●
Softsynchro® 4	M12 - M30 (7/16 - 1 1/8)	9 - 22	ER 40 (GB)	Hi-Q/ERC 40	PSC 63	63	63	—	129,5	38	5	M20 x 2	0,7	0,7	F3154T06.1	●
					PSC 80	63	63	—	134	48	5	M20 x 2	0,7	0,7	F3154T08.1	○

1) Einstecktiefen E siehe Seite 797
Clamping depths E, see page 797

Weitere Ausführungen auf Anfrage
Further designs upon request

Softsynchro® 0

Spannmutter ohne integrierte Abdichtung ist im Lieferumfang enthalten
Clamping nut without integrated seal is included in the delivery

Softsynchro® 1-4

Spannmutter für Dichtscheiben ist im Lieferumfang enthalten
Clamping nut for sealing disks is included in the delivery

Zubehör

Accessories



Spannzangen Typ ER (GB)
Collets type ER (GB)

» 786 - 787



Dichtscheiben Typ DS/ER
Sealing disks type DS/ER

» 789



Spannmutter mit integrierter
Abdichtung Typ Hi-Q/ERM 11
Clamping nut with integrated seal,
type Hi-Q/ERM 11

» 790



Spannschlüsselsatz
Set of clamping wrenches

» 793



Montagevorrichtung
Assembly device

» 793



Drehmomentschlüssel TORCO-FIX
Torque wrenches TORCO-FIX

» 795



- Product Finder
- Soft-synchro
- Speed-synchro
- KSN
- MQL MMS
- SFM
- SWITCH-MASTER
- GR, GR-S
- HF
- EM
- Zubehör Accessories
- Tech. Info

Softsynchro®

DIN 1835 B+E



p_{max}
50bar
(700psi)

p_{max}
6bar
(85psi)

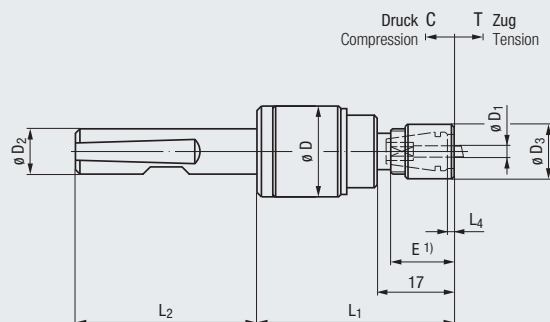

Einsatz auf Maschinen mit Synchronspindel For use on machines with synchronous spindle

Typ Type		$\varnothing D_1$			$\varnothing D_2$ h6	$\varnothing D$	$\varnothing D_3$	L_1	L_2	L_4	C	T	Artikel-Nr. Article no.
Softsynchro® Micro	M0,5 - M4 (Nr.0 - Nr.8)	2 - 4,5	ER 8	Hi-Q/ERM 8	10	20	12	43,5	40	1,5	0,2	0,2	F3150G22

1) Einstecktiefen E siehe Seite 797
Clamping depths E, see page 797

Weitere Ausführungen auf Anfrage
Further designs upon request

Spannmutter ohne integrierte Abdichtung ist im Lieferumfang enthalten
Clamping nut without integrated seal is included in the delivery

Zubehör Accessories



Spannzangen Typ ER (GB)
Collets type ER (GB)

» 786 - 787



Spannschlüsselsatz
Set of clamping wrenches

» 793



Drehmomentschlüssel TORCO-FIX
Torque wrenches TORCO-FIX

» 795

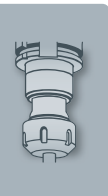

Softsynchro®

DIN 1835 B+E

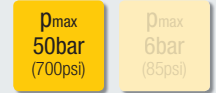
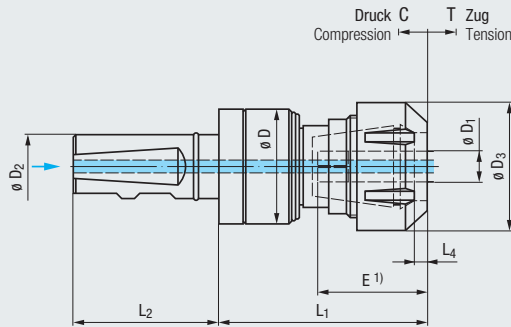

Einsatz auf Maschinen mit Synchronspindel For use on machines with synchronous spindle

Typ Type		$\varnothing D_1$			$\varnothing D_2$	$\varnothing D$	$\varnothing D_3$	L_1 ER	L_1 ER-GB	L_2	L_4	C	T	Artikel-Nr. Article no.	
Softsynchro® 0	M2 - M8 (Nr.2 - 5/16)	2,5 - 7	ER 11 (GB)	Hi-Q/ERM 11	16	34	16	72,7	71	49	0,9	0,5	0,5	F3150G24.1.44	●
					20	34	16	72,7	71	51	0,9	0,5	0,5	F3150G25.1.44	●
					25	34	16	72,7	71	57	0,9	0,5	0,5	F3150G26.1.44	●
Softsynchro® 1	M4 - M12 (Nr.8 - 7/16)	4,5 - 10	ER 20 (GB)	Hi-Q/ERC 20	20	34	34	-	73	51	5	0,5	0,5	F3151G25.1.44	●
					25	34	34	-	73	57	5	0,5	0,5	F3151G26.1.44	●
Softsynchro® 3	M4 - M20 (Nr.8 - 3/4)	4,5 - 16	ER 32 (GB)	Hi-Q/ERC 32	25	45	50	-	87,3	57	5	0,5	0,5	F3153G26.1.44	●
Softsynchro® 4	M12 - M30 (7/16 - 1 1/8)	9 - 22	ER 40 (GB)	Hi-Q/ERC 40	32	63	63	-	113,5	61	5	0,7	0,7	F3154G27.1	●

1) Einstecktiefen E siehe Seite 797
Clamping depths E, see page 797

Weitere Ausführungen auf Anfrage
Further designs upon request

Softsynchro® 0

Spannmutter ohne integrierte Abdichtung ist im Lieferumfang enthalten
Clamping nut without integrated seal is included in the delivery

Softsynchro® 1-4

Spannmutter für Dichtscheiben ist im Lieferumfang enthalten
Clamping nut for sealing disks is included in the delivery

Zubehör

Accessories



Adaptionsschäfte
Adapter shanks

▶ ▶ 780



Spannzangen Typ ER (GB)
Collets type ER (GB)

▶ ▶ 786 - 787



Dichtscheiben Typ DS/ER
Sealing disks type DS/ER

▶ ▶ 789



Spannmutter mit integrierter
Abdichtung Typ Hi-Q/ERM 11
Clamping nut with integrated seal,
type Hi-Q/ERM 11

▶ ▶ 790



Spannschlüsselsatz
Set of clamping wrenches

▶ ▶ 793



Montagevorrichtung
Assembly device

▶ ▶ 793



Drehmomentschlüssel TORCO-FIX
Torque wrenches TORCO-FIX

▶ ▶ 795



- Product Finder
- Soft-synchro
- Speed-synchro
- KSN
- MQL MMS
- SFM
- SWITCH-MASTER
- GR, GR-S
- HF
- EM
- Zubehör Accessories
- Tech. Info

Softsynchro®

DIN 1835 A



p_{max}
50bar
(700psi)

p_{max}
6bar
(85psi)

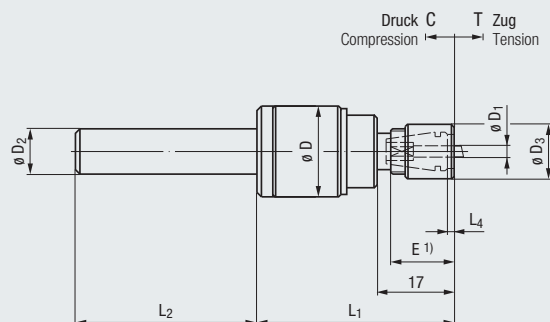

Einsatz auf Maschinen mit Synchronspindel For use on machines with synchronous spindle

Typ Type		$\varnothing D_1$			$\varnothing D_2$ h6	$\varnothing D$	$\varnothing D_3$	L_1	L_2	L_4	C	T	Artikel-Nr. Article no.
Softsynchro® Micro	M0,5 - M4 (Nr.0 - Nr.8)	2 - 4,5	ER 8	Hi-Q/ERM 8	10	20	12	43,5	40	1,5	0,2	0,2	F3150900

1) Einstecktiefen E siehe Seite 797
Clamping depths E, see page 797

Weitere Ausführungen auf Anfrage
Further designs upon request

Spannmutter ohne integrierte Abdichtung ist im Lieferumfang enthalten
Clamping nut without integrated seal is included in the delivery

Zubehör Accessories



Spannzangen Typ ER (GB)
Collets type ER (GB)

» 786 - 787



Spannschlüsselsatz
Set of clamping wrenches

» 793



Drehmomentschlüssel TORCO-FIX
Torque wrenches TORCO-FIX

» 795

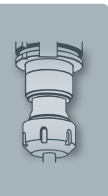

Informationen zur neuen **EG-Maschinenrichtlinie 2006/42/EG**,
siehe Seite 656

Information regarding the new **EC Machinery Directive 2006/42/EC**,
see page 656

Lange Bauform
Long design

Softsynchro®
≈ DIN 1835 A

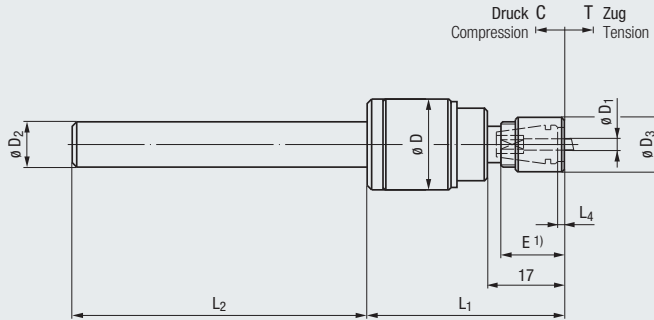

Einsatz auf Maschinen
mit Synchronspindel

For use on machines
with synchronous spindle

Typ Type		ø D ₁			ø D ₂ h6	ø D	ø D ₃	L ₁	L ₂	L ₄	C	T	Artikel-Nr. Article no.
Softsynchro® Micro	M0,5 - M4 (Nr.0 - Nr.8)	2 - 4,5	ER 8	Hi-Q/ERM 8	10	20	12	43,5	66	1,5	0,2	0,2	F3150901

1) Einstecktiefen E siehe Seite 797
Clamping depths E, see page 797

Weitere Ausführungen auf Anfrage
Further designs upon request

Spannmutter ohne integrierte Abdichtung ist im Lieferumfang enthalten
Clamping nut without integrated seal is included in the delivery

Zubehör
Accessories



Spannzangen Typ ER (GB)
Collets type ER (GB)

» 786 - 787



Spannschlüsselsatz
Set of clamping wrenches

» 793



Drehmomentschlüssel TORCO-FIX
Torque wrenches TORCO-FIX

» 795

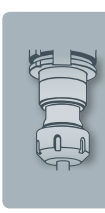

Softsynchro®

DIN 69871 AD
DIN 69871 B



p_{max} 50bar (700psi)	p_{max} 6bar (85psi)	

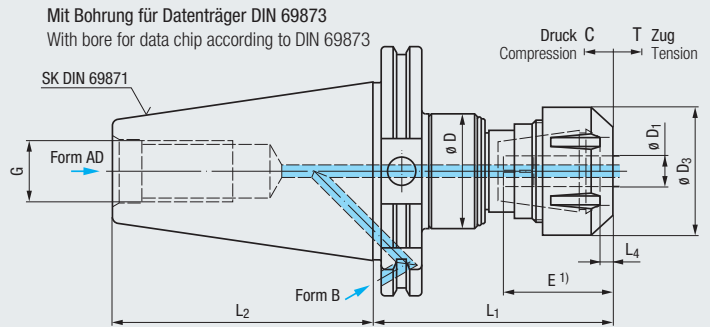

Einsatz auf Maschinen mit Synchronspindel For use on machines with synchronous spindle

Typ Type		$\varnothing D_1$			SK	$\varnothing D$	$\varnothing D_3$	L_1	L_2	L_4	G	C	T	Artikel-Nr. Article no.	
Softsynchro® 1	M4 - M12 (Nr.8 - 7/16)	4,5 - 10	ER 20 (GB)	Hi-Q/ERC 20	SK 40 AD	34	34	85	68,4	5	M16	0,5	0,5	F3151651.1	●
					SK 40 B	34	34	85	68,4	5	M16	0,5	0,5	F3151651.2	●
					SK 50 AD	34	34	85	101,75	5	M24	0,5	0,5	F3151653.1	●
					SK 50 B	34	34	85	101,75	5	M24	0,5	0,5	F3151653.2	●
Softsynchro® 3	M4 - M20 (Nr.8 - 3/4)	4,5 - 16	ER 32 (GB)	Hi-Q/ERC 32	SK 40 AD	45	50	93,5	68,4	5	M16	0,5	0,5	F3153651.1	●
					SK 40 B	45	50	93,5	68,4	5	M16	0,5	0,5	F3153651.2	●
					SK 50 AD	45	50	93,5	101,75	5	M24	0,5	0,5	F3153653.1	●
					SK 50 B	45	50	93,5	101,75	5	M24	0,5	0,5	F3153653.2	●

1) Einstecktiefen E siehe Seite 797
Clamping depths E, see page 797

Weitere Ausführungen auf Anfrage
Further designs upon request

Spannmutter für Dichtscheiben ist im Lieferumfang enthalten
Clamping nut for sealing disks is included in the delivery

Zubehör Accessories

Spannzangen Typ ER (GB)
Collets type ER (GB) » 786 - 787

Dichtscheiben Typ DS/ER
Sealing disks type DS/ER » 789

Spanschlüsselsatz
Set of clamping wrenches » 793

Montagevorrichtung
Assembly device » 793

Drehmomentschlüssel TORCO-FIX
Torque wrenches TORCO-FIX » 795

Softsynchro®

DIN 69871 AD
DIN 69871 B

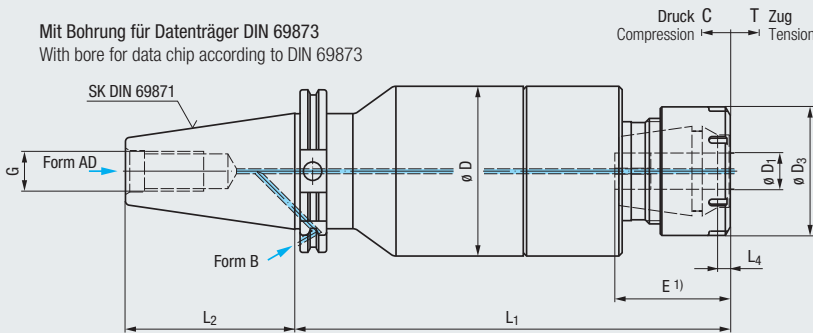
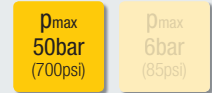
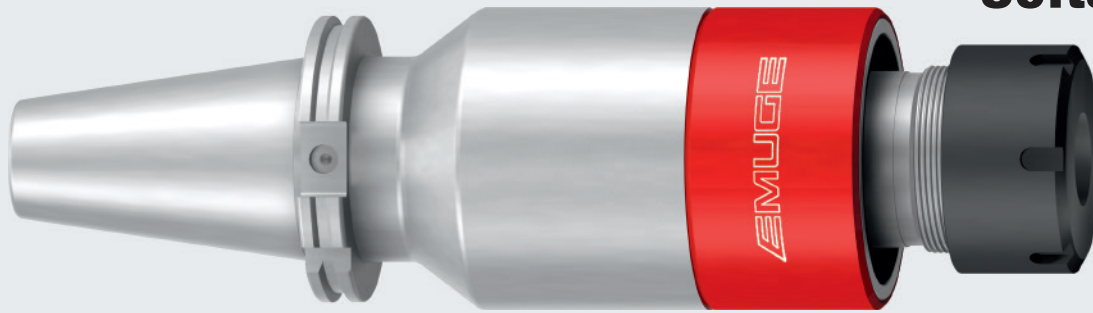

Einsatz auf Maschinen mit Synchronspindel For use on machines with synchronous spindle

Typ Type		ø D ₁			SK	ø D	ø D ₃	L ₁ ER	L ₁ ER-GB	L ₂	L ₄	G	C	T	Artikel-Nr. Article no.	
Softsynchro® 5	M30 - M48 (1 1/8 - 1 3/4)	22 - 36	ER 50 (GB)	Hi-Q/ERBC 50	SK 50 AD	103	78	267,5	264	101,75	8	M24	2	2	F3155653.1	●
					SK 50 B	103	78	267,5	264	101,75	8	M24	2	2	F3155653.2	○

¹⁾ Einstecktiefen E siehe Seite 797
Clamping depths E, see page 797

Weitere Ausführungen auf Anfrage
Further designs upon request

Spannmutter für Dichtscheiben ist im Lieferumfang enthalten
Clamping nut for sealing disks is included in the delivery

Vierkantaufnahme für Werkzeuge mit Schaftdurchmesser 36 mm im Futterkörper integriert
Square seat for tools with shank diameter 36 mm is integrated in the tap holder body

Zubehör Accessories



Spannzangen Typ ER (GB)
Collets type ER (GB) ▶▶ 786 - 787



Dichtscheiben Typ DS/ER
Sealing disks type DS/ER ▶▶ 789



Spannschlüssel
Clamping wrenches ▶▶ 793



Drehmomentschlüssel TORCO-FIX
Torque wrenches TORCO-FIX ▶▶ 795

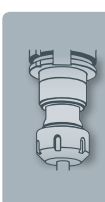

Softsynchro®

DIN 69871 AD



Einsatz auf Maschinen mit Synchronspindel

For use on machines with synchronous spindle

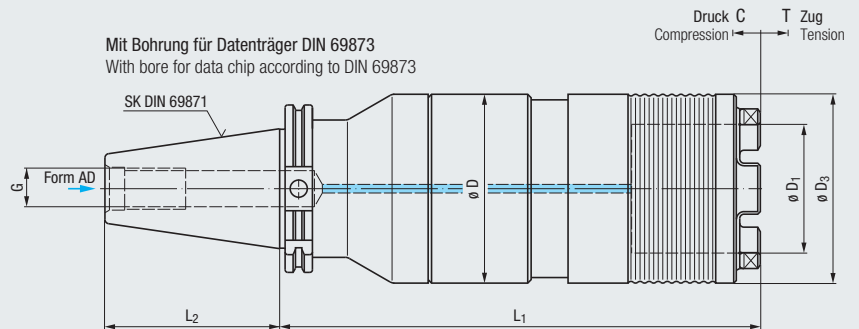

Typ Type			SK	ø D	ø D ₁	ø D ₃	L ₁	L ₂	G	C	T	Artikel-Nr. Article no.
Softsynchro® 6	M45 - M76 (1 3/8 - 2 3/8)	HE2/IKZZ	SK 50 AD	110	75	110	280	101,75	M24	2	2	F3156653.1

Weitere Ausführungen auf Anfrage
Further designs upon request

Zubehör Accessories



Schnellwechsel-Einsätze Typ HE2/IKZZ
Quick-change adapters type HE2/IKZZ ▶ 752



Weitere Schnellwechsel-Aufnahmen (Typenreihe HF) zur Herstellung von großen Gewinden siehe Seite 747 - 754

Further quick-change tap holders (HF series) for the production of large threads, see pages 747 - 754

Für angetriebene Werkzeuge
For driven tools

Softsynchro®
mimatic®

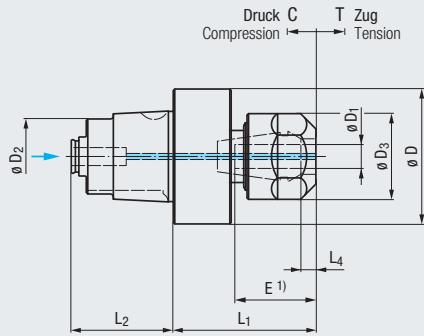

p_{max}
70bar
(1015psi)

p_{max}
6bar
(85psi)

Einsatz auf Maschinen mit Synchronspindel For use on machines with synchronous spindle

Typ Type		$\varnothing D_1$			$\varnothing D_2$	$\varnothing D$	$\varnothing D_3$	L_1 ER	L_1 ER-GB	L_2	L_4	C	T	Artikel-Nr. Article no.		
Softsynchro® 1	M4 - M12 (Nr.8 - 7/16)	4,5 - 10	ER 16 (GB)	Hi-Q/ERC 16	MI 40	25	45	28	51	47,5	34	5	0,5	0,5	F3151Z40.M01001	○
					MI 50	33	55	28	48	44,5	41	5	0,5	0,5	F3151Z50.M01001	○

1) Einstecktiefen E siehe Seite 797
Clamping depths E, see page 797

Weitere Ausführungen auf Anfrage
Further designs upon request

Spannmutter für Dichtscheiben ist im Lieferumfang enthalten
Clamping nut for sealing disks is included in the delivery

Vierkantaufnahme für Werkzeuge mit Schaftdurchmesser 9 und 10 mm im Futterkörper integriert
Square seat for tools with shank diameter 9 and 10 mm is integrated in the tap holder body

Zubehör
Accessories

Spannzangen Typ ER (GB)
Collets type ER (GB) ▶▶ 786 - 787

Dichtscheiben Typ DS/ER
Sealing disks type DS/ER ▶▶ 789

Spannschlüsselsatz
Set of clamping wrenches ▶▶ 793

Drehmomentschlüssel TORCO-FIX
Torque wrenches TORCO-FIX ▶▶ 795

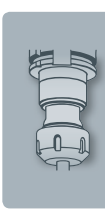

- Product Finder
- Softsynchro
- Speedsynchro
- KSN
- ML MMS
- SFM
- SWITCH-MASTER
- GR, GR-S
- HF
- EM
- Zubehör
Accessories
- Tech. Info

Softsynchro®

heimatec®

Für angetriebene Werkzeuge
For driven tools

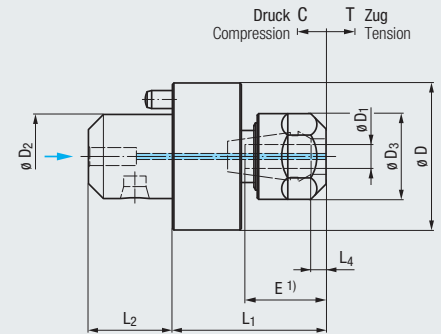
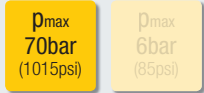
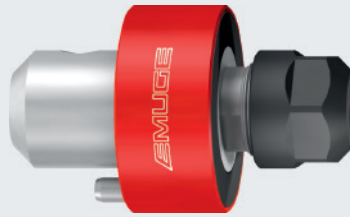

Einsatz auf Maschinen mit Synchronspindel For use on machines with synchronous spindle

Typ Type		$\varnothing D_1$				$\varnothing D_2$	$\varnothing D$	$\varnothing D_3$	L ₁ ER	L ₁ ER-GB	L ₂	L ₄	C	T	Artikel-Nr. Article no.	
Softsynchro® 1	M4 - M12 (Nr.8 - 7/16)	4,5 - 10	ER 16 (GB)	Hi-Q/ERC 16	HT4	22	39	28	55	51,5	21,5	5	0,5	0,5	F3151Z04.H01001	○
					HT5	28	49	28	55	51,5	28	5	0,5	0,5	F3151Z05.H01001	○
					HT6	36	64	28	48	44,5	28	5	0,5	0,5	F3151Z06.H01001	○

1) Einstecktiefen E siehe Seite 797
Clamping depths E, see page 797

Weitere Ausführungen auf Anfrage
Further designs upon request

Spannmutter für Dichtscheiben ist im Lieferumfang enthalten
Clamping nut for sealing disks is included in the delivery

Vierkantaufnahme für Werkzeuge mit Schaftdurchmesser 9 und 10 mm im Futterkörper integriert
Square seat for tools with shank diameter 9 and 10 mm is integrated in the tap holder body

Zubehör Accessories



Spannzangen Typ ER (GB)
Collets type ER (GB)

» 786 - 787



Dichtscheiben Typ DS/ER
Sealing disks type DS/ER

» 789



Spannschlüsselsatz
Set of clamping wrenches

» 793



Drehmomentschlüssel TORCO-FIX
Torque wrenches TORCO-FIX

» 795

Für angetriebene Werkzeuge
For driven tools

Softsynchro®

W&F

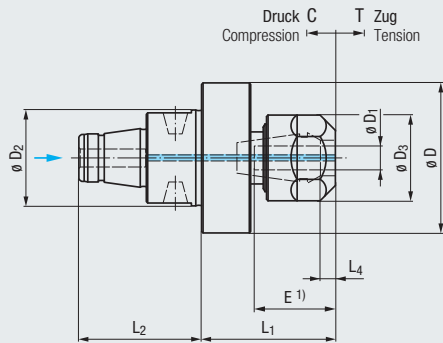
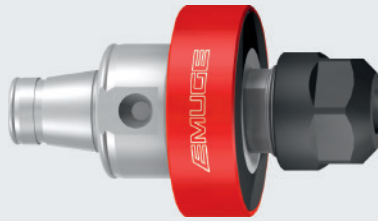

Einsatz auf Maschinen mit Synchronspindel For use on machines with synchronous spindle

Typ Type		$\varnothing D_1$				$\varnothing D_2$	$\varnothing D$	$\varnothing D_3$	L_1 ER	L_1 ER-GB	L_2	L_4	C	T	Artikel-Nr. Article no.	
Softsynchro® 1	M4 - M12 (Nr.8 - 7/16)	4,5 - 10	ER 16 (GB)	Hi-Q/ERC 16	WFB 32-20	32	50	28	48	44,5	41	5	0,5	0,5	F3151Z32.W01001	○
					WFB 40-25	40	63	28	48	44,5	46	5	0,5	0,5	F3151Z40.W01001	○
					WFB 50-32	48	75	28	48	44,5	54	5	0,5	0,5	F3151Z50.W01001	○

1) Einstecktiefen E siehe Seite 797
Clamping depths E, see page 797

Weitere Ausführungen auf Anfrage
Further designs upon request

Spannmutter für Dichtscheiben ist im Lieferumfang enthalten
Clamping nut for sealing disks is included in the delivery

Vierkantaufnahme für Werkzeuge mit Schaftdurchmesser 9 und 10 mm im Futterkörper integriert
Square seat for tools with shank diameter 9 and 10 mm is integrated in the tap holder body

Zubehör
Accessories



Spannzangen Typ ER (GB)
Collets type ER (GB) ▶▶ 786 - 787



Dichtscheiben Typ DS/ER
Sealing disks type DS/ER ▶▶ 789



Spannschlüsselsatz
Set of clamping wrenches ▶▶ 793



Drehmomentschlüssel TORCO-FIX
Torque wrenches TORCO-FIX ▶▶ 795

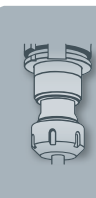

Softsynchro®/PGR

DIN 69893 A

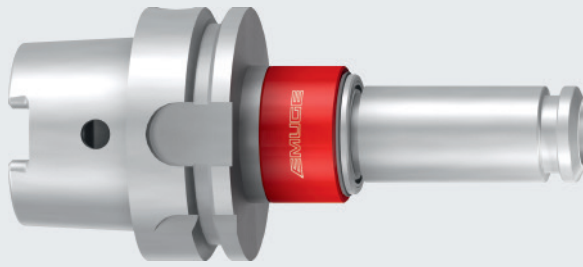

Mit Bohrung für Datenträger DIN 69873
With bore for data chip according to DIN 69873

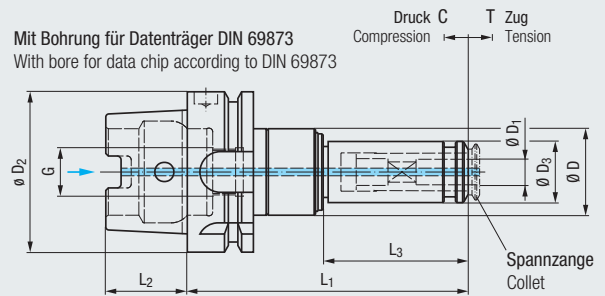

Einsatz auf Maschinen mit Synchronspindel For use on machines with synchronous spindle

Typ Type		$\varnothing D_1$		$\varnothing D_2$	$\varnothing D$	$\varnothing D_3$	L_1	L_2	L_3	G	C	T	Artikel-Nr. Article no.	
Softsynchro® 1/PGR	M4 - M12 (Nr.8 - 7/16)	4,5 - 10	PGR 15 GB	HSK-A50	34	24	108	25	57	M16 x 1	0,5	0,5	F3221C03.1	○
				HSK-A63	34	24	110	32	57	M18 x 1	0,5	0,5	F3221C04.1	●
				HSK-A80	34	24	114,5	40	57	M20 x 1,5	0,5	0,5	F3221C05.1	○
				HSK-A100	34	24	116,5	50	57	M24 x 1,5	0,5	0,5	F3221C06.1	●
Softsynchro® 3/PGR	M8 - M20 (5/16 - 3/4)	8 - 16	PGR 25 GB	HSK-A50	45	40	132,5	25	67	M16 x 1	0,5	0,5	F3223C03.1	○
				HSK-A63	45	40	125	32	67	M18 x 1	0,5	0,5	F3223C04.1	●
				HSK-A80	45	40	129,5	40	67	M20 x 1,5	0,5	0,5	F3223C05.1	●
				HSK-A100	45	40	131,5	50	67	M24 x 1,5	0,5	0,5	F3223C06.1	●

Weitere Ausführungen auf Anfrage
Further designs upon request

Zubehör Accessories

Spannzangen Typ PGR-GB
Collets type PGR-GB **» 796**

Kühlschmierstoffrohre und Schlüssel
Coolant tubes and wrenches **» 782 - 783**



Reinigung von Spannzangen-Aufnahme
und Spannzange Typ PGR
siehe Seite 835

Cleaning of collet holder
and collet type PGR,
see page 835

Softsynchro®/PGR

DIN 1835 B+E

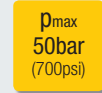
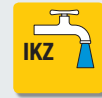
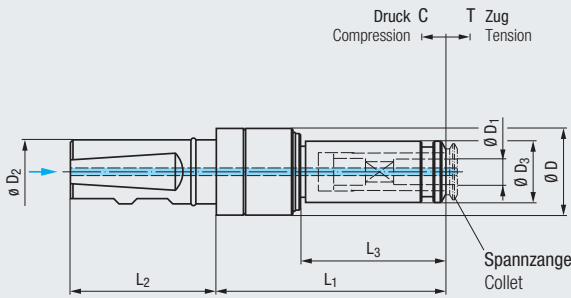

Einsatz auf Maschinen mit Synchronspindel

For use on machines with synchronous spindle

Typ Type		ø D ₁		ø D ₂	ø D	ø D ₃	L ₁	L ₂	L ₃	C	T	Artikel-Nr. Article no.	
Softsynchro® 1/PGR	M4 - M12 (Nr.8 - 7/16)	4,5 - 10	PGR 15 GB	25	34	24	87,5	57	57	0,5	0,5	F3221G26.1.44	●
Softsynchro® 3/PGR	M8 - M20 (5/16 - 3/4)	8 - 16	PGR 25 GB	25	45	40	103,5	57	67	0,5	0,5	F3223G26.1.44	●

Weitere Ausführungen auf Anfrage
Further designs upon request

Zubehör Accessories



Spannzangen Typ PGR-GB
Collets type PGR-GB

» 796



Adaptionsschäfte
Adapter shanks

» 780



- Product Finder
- Soft-synchro
- Speed-synchro**
- KSN
- MQL MMS
- SFM
- SWITCH-MASTER
- GR, GR-S
- HF
- EM
- Zubehör Accessories
- Tech. Info



EMUGE
SPEEDSYNCHRO®
Modular/IKZ
F3741L01
n max. Antrieb 2000 1/min
ratio = 1 : 4,412
p max. IKZ 50 bar
M1-M8
Made in Germany
11/1-02

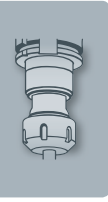

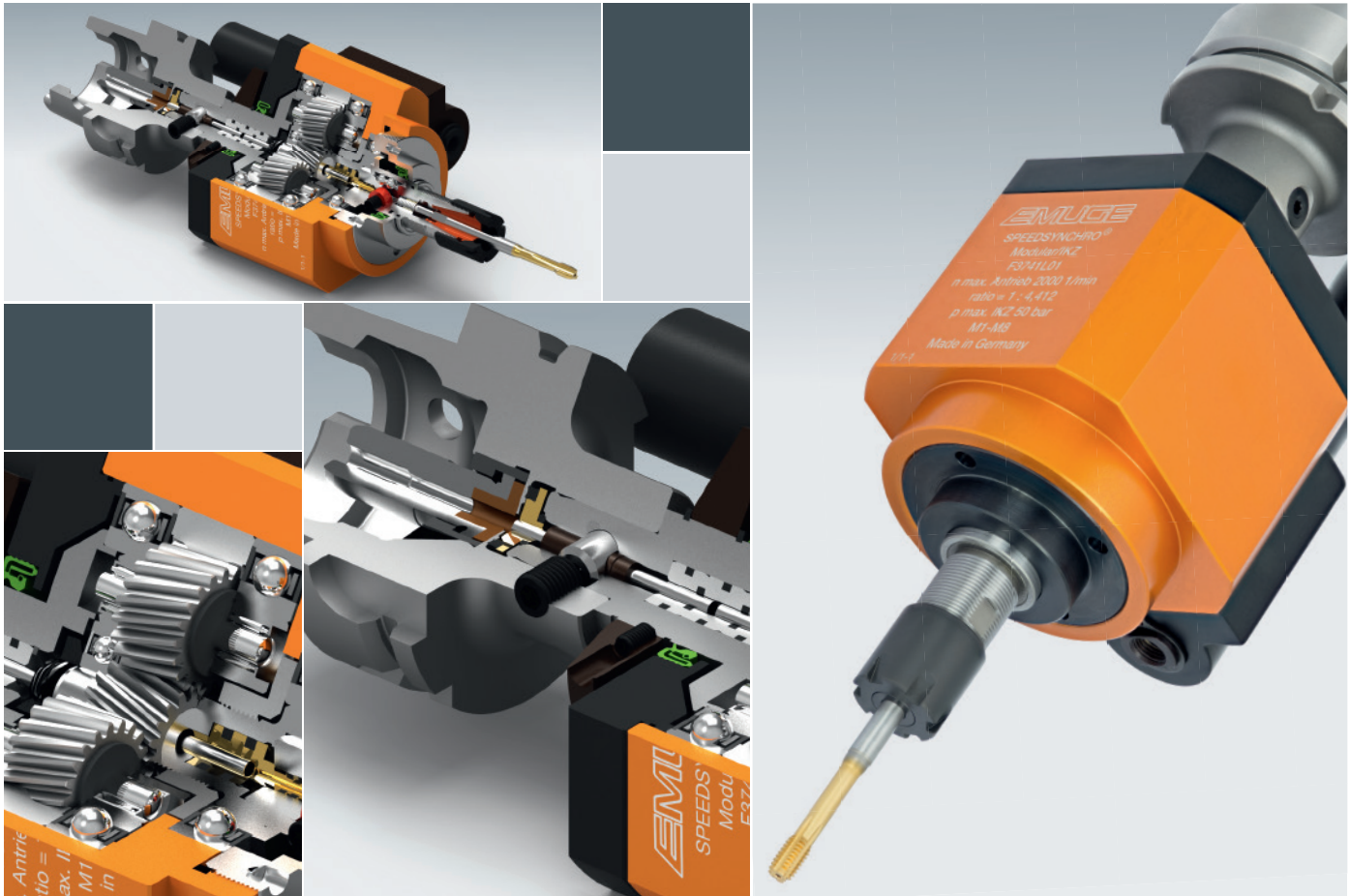

Typenreihe Speedsynchro® Modular Speedsynchro® Modular Series

Softsynchro®-Technologie mit Übersetzungsgetriebe

Das Speedsynchro® Modular verfügt über ein integriertes Übersetzungsgetriebe mit einem Übersetzungsverhältnis von 1 : 4,412 und ist mit der patentierten Softsynchro®-Minimallängenausgleichsfunktion kombiniert.

Für eine hohe Werkzeumdrehzahl bei niedriger Spindeldrehzahl zur Taktzeiteinsparung, Energieeinsparung, Axialkraftreduzierung und Erhöhung der Wirtschaftlichkeit.

Softsynchro® technology with transmission gearing

The Speedsynchro Modular® uses an integrated transmission gearing with a transmission ratio of 1:4.412 and combines it with the patented Softsynchro® minimal length compensation function.

For achieving a high tool speed at a low spindle speed in order to reduce cycle time, save energy, reduce axial force and increase efficiency.



Speedsynchro® Modular/IKZ

DIN 1835 B



IKZ

MMS
MQL

p_{max}
50bar
(700psi)

p_{max}
6bar
(85psi)

L+ 2 mm

C Soft

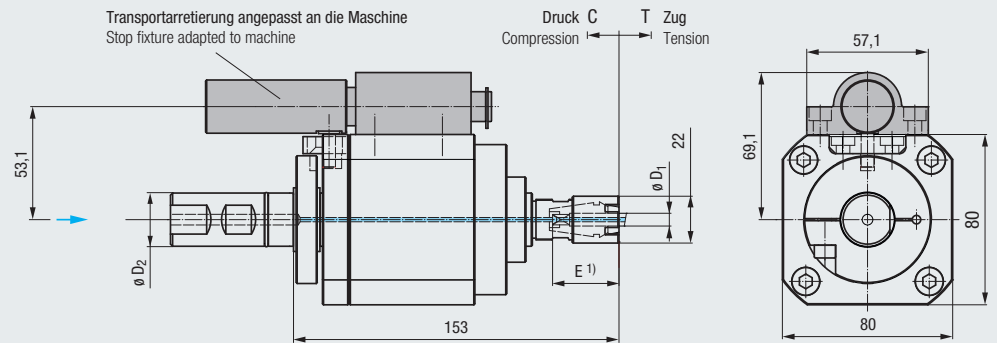

Einsatz auf Maschinen mit Synchronspindel For use on machines with synchronous spindle

new										
Typ Type				$\varnothing D_2$	$\varnothing D_1$	Max. Spindeldrehzahl Max. spindle speed	Übersetzungsverhältnis Transmission ratio	C	T	Artikel-Nr. Article no.
Speedsynchro® Modular/IKZ	M1 - M8	ER 16 (GB)	Hi-Q/ERMC 16	25	2,5 - 8	2000	1 : 4,412	0,5	0,5	F3741G26

1) Einstecktiefen E siehe Seite 797
Clamping depths E, see page 797

Adaptionsschäft, Transportarretierung (siehe auch Seite 827) und Längeneinstellschraube sind nicht im Lieferumfang enthalten, bitte extra bestellen
Adapter shank, stop fixture (see also page 827) and length adjustment screw are not included in the delivery, please order separately

Zubehör Accessories



Adaptionsschäfte
Adapter shanks



Montagevorrichtung
Assembly device



Spannzangen Typ ER (GB)
Collets type ER (GB)



Längeneinstellschrauben
Length adjustment screws



Dichtscheiben Typ DS/ER
Sealing disks type DS/ER



Mehr Informationen zum
Speedsynchro® Modular unter

More information regarding
Speedsynchro® Modular at

www.speedsynchro.com

Speedsynchro® Modular/IKZ

ABS®

(System KOMET)



IKZ

MMS
MQL

p_{max}
50bar
(700psi)

p_{max}
6bar
(85psi)

L+ 2 mm

↔
C T
Soft

F

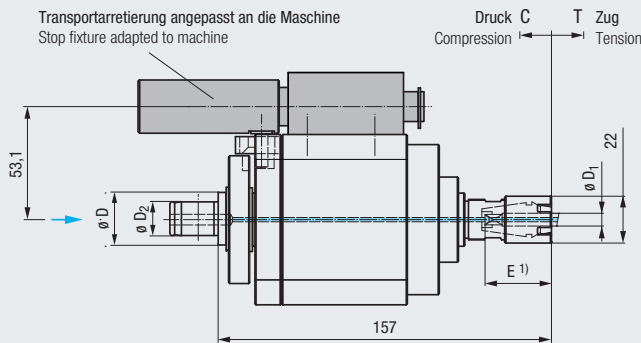

Einsatz auf Maschinen mit Synchronspindel

For use on machines with synchronous spindle

new												
Typ Type				$\varnothing D$	$\varnothing D_2$	$\varnothing D_1$	Max. Spindeldrehzahl Max. spindle speed	Übersetzungsverhältnis Transmission ratio	C	T	Artikel-Nr. Article no.	
Speedsynchro® Modular/IKZ	M1 - M8	ER 16 (GB)	Hi-Q/ERMC 16	ABS 32	16	2,5 - 8	2000	1:4,412	0,5	0,5	F3741L01	●

1) Einsteektiefen E siehe Seite 797
Clamping depths E, see page 797

Adaptionsschäfte, Transportarretierung (siehe auch Seite 827) und Längeneinstellschraube sind nicht im Lieferumfang enthalten, bitte extra bestellen
Adapter shank, stop fixture (see also page 827) and length adjustment screw are not included in the delivery, please order separately

Zubehör Accessories



Adaptionsschäfte
Adapter shanks

» 781



Montagevorrichtung
Assembly device

» 793



Spannzangen Typ ER (GB)
Collets type ER (GB)

» 786 - 787



Längeneinstellschrauben
Length adjustment screws

» 785



Dichtscheiben Typ DS/ER
Sealing disks type DS/ER

» 789

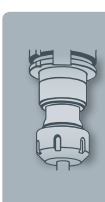

- Product Finder
- Soft-synchro
- Speed-synchro**
- KSN
- MQL MMS
- SFM
- SWITCH-MASTER
- GR, GR-S
- HF
- EM
- Zubehör Accessories
- Tech. Info

Speedsynchro® Modular/MQL

ABS®

(System KOMET)

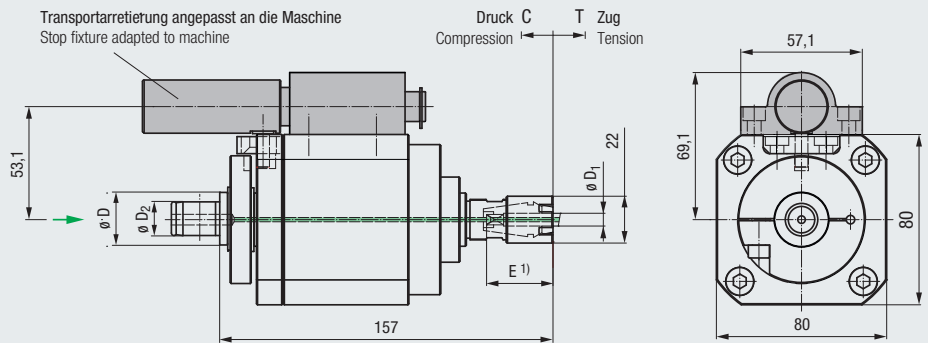
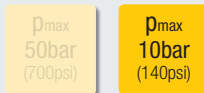

Einsatz auf Maschinen mit Synchronspindel For use on machines with synchronous spindle

new					$\varnothing D$	$\varnothing D_2$	$\varnothing D_1$	Max. Spindeldrehzahl Max. spindle speed	Übersetzungsverhältnis Transmission ratio	C	T	Artikel-Nr. Article no.
Typ Type												
Speedsynchro® Modular/MQL	M1 - M8	ER 16 (GB)	Hi-Q/ERMC 16	ABS 32	16	2,5 - 8	2000	1 : 4,412	0,5	0,5	F3751L01	●

1) Einstecktiefen E siehe Seite 797
Clamping depths E, see page 797

Adaptionsschäft, Transportarretierung (siehe auch Seite 827) und Längeneinstellschraube sind nicht im Lieferumfang enthalten, bitte extra bestellen
Adapter shank, stop fixture (see also page 827) and length adjustment screw are not included in the delivery, please order separately

Zubehör Accessories



Adaptionsschäfte
Adapter shanks ▶▶ 781



Montagevorrichtung
Assembly device ▶▶ 793



Spannzangen Typ ER (GB)
Collets type ER (GB) ▶▶ 786 - 787



Längeneinstellschrauben
Length adjustment screws ▶▶ 785



Dichtscheiben Typ DS/ER
Sealing disks type DS/ER ▶▶ 789



Mehr Informationen zum
Speedsynchro® Modular unter

More information regarding
Speedsynchro® Modular at

www.speedsynchro.com

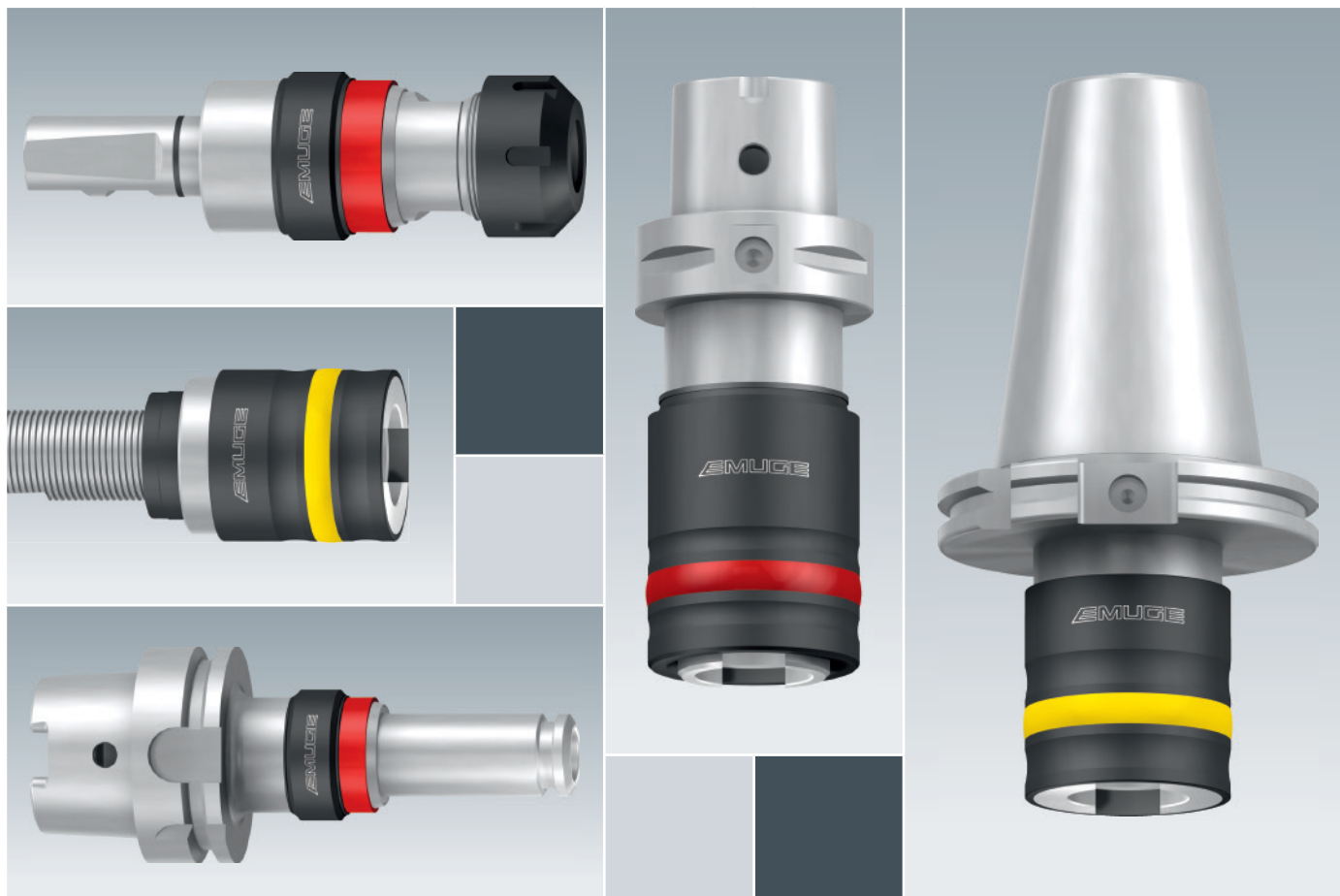

Typenreihe KSN KSN Series

Einsatz auf CNC-Bearbeitungszentren und konventionellen Werkzeugmaschinen

Die Genauigkeit der programmierten Gewindetiefe wird durch den patentierten Druckpunktmechanismus garantiert. Auftretende Differenzen zwischen dem Maschinenvorschub und der Gewindesteigung werden durch einen Längenausgleich kompensiert.

Application on CNC machining centres and conventional machine tools

The accuracy of the programmed thread depth is guaranteed by a patent-protected pressure point mechanism. Arising differences between spindle feed and thread pitch are compensated by a length compensation.



KSN DIN 69893 A

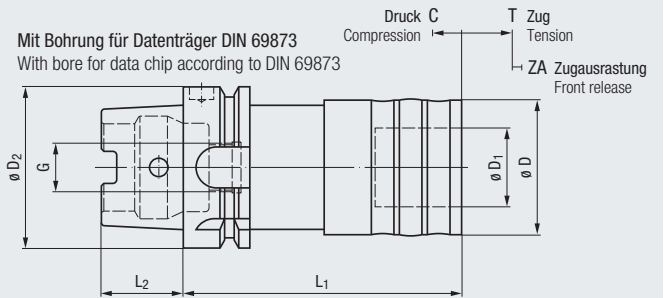
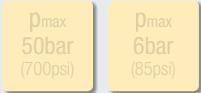
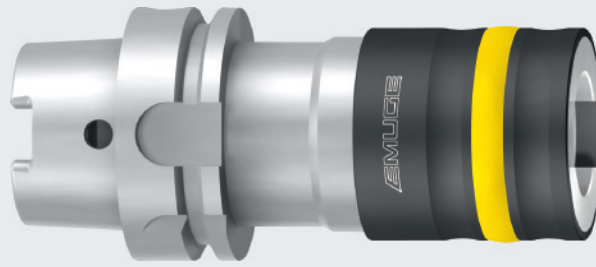

Einsatz auf CNC-Bearbeitungszentren, sonstigen Werkzeugmaschinen und Säulenbohrmaschinen

For use on CNC machining centres, other machine tools and pillar drilling machines

Typ Type			$\varnothing D_2$	$\varnothing D$	$\varnothing D_1$	L_1	L_2	G	C	T	ZA	Artikel-Nr. Article no.	
KSN 1	M3 - M14 (Nr.4 - 9/16)	EM 01	HSK-A32	36	19	71	16	M10 x 1	5	8	2,1	F3301C01.30	●
			HSK-A40	36	19	73	20	M12 x 1	5	8	2,1	F3301C02.30	●
			HSK-A50	36	19	77	25	M16 x 1	5	8	2,1	F3301C03.30	●
			HSK-A63	36	19	79	32	M18 x 1	5	8	2,1	F3301C04.30	●
			HSK-A80	36	19	83,5	40	M20 x 1,5	5	8	2,1	F3301C05.30	●
			HSK-A100	36	19	85,5	50	M24 x 1,5	5	8	2,1	F3301C06.30	●
KSN 3	M4,5 - M24 (Nr.10 - 1")	EM 03	HSK-A40	53	31	107	20	M12 x 1	8,5	15	2,8	F3303C02.30	○
			HSK-A50	53	31	111	25	M16 x 1	8,5	15	2,8	F3303C03.30	●
			HSK-A63	53	31	113	32	M18 x 1	8,5	15	2,8	F3303C04.30	●
			HSK-A80	53	31	117,5	40	M20 x 1,5	8,5	15	2,8	F3303C05.30	●
			HSK-A100	53	31	119,5	50	M24 x 1,5	8,5	15	2,8	F3303C06.30	●
KSN 4	M14 - M36 (9/16 - 1 3/8)	EM 04	HSK-A63	78	48	164	32	M18 x 1	15	23,5	4,1	F3304C04.30	●
			HSK-A80	78	48	168,5	40	M20 x 1,5	15	23,5	4,1	F3304C05.30	○
			HSK-A100	78	48	170,5	50	M24 x 1,5	15	23,5	4,1	F3304C06.30	●
KSN 5	M22 - M48 (7/8 - 1 3/4)	EM 05	HSK-A80	96	60	203	40	M20 x 1,5	16,5	25	5,7	F3305C05.30	○
			HSK-A100	96	60	205	50	M24 x 1,5	16,5	25	5,7	F3305C06.30	●

Weitere Ausführungen auf Anfrage
Further designs upon request

Zubehör Accessories



Schnellwechsel-Einsätze Typenreihe EM
Quick-change adapters EM series ▶▶ 755 - 778



Kühlschmierstoffrohre und Schlüssel
Coolant tubes and wrenches ▶▶ 782 - 783



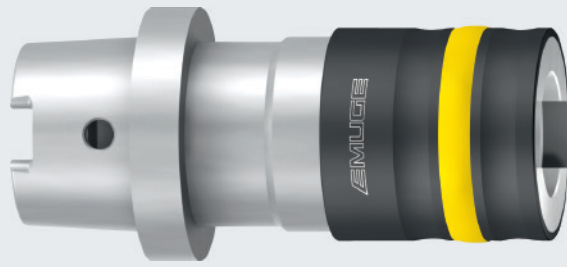

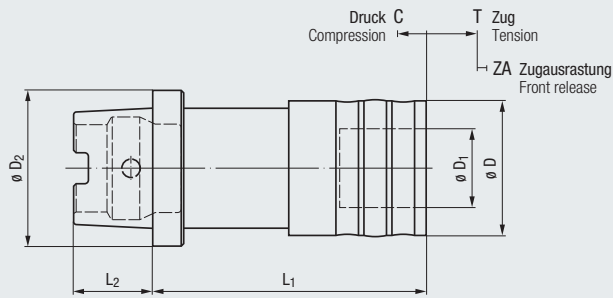
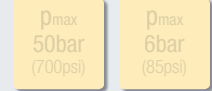

KSN
DIN 69893 C



Einsatz auf CNC-Bearbeitungszentren,
sonstigen Werkzeugmaschinen und
Säulenbohrmaschinen

For use on CNC machining centres,
other machine tools and pillar
drilling machines

Typ Type			$\varnothing D_2$	$\varnothing D$	$\varnothing D_1$	L_1	L_2	C	T	ZA	Artikel-Nr. Article no.	
KSN 1	M3 - M14 (Nr.4 - 9/16)	EM 01	HSK-C32	36	19	65	16	5	8	2,1	F3301K01.30	●
			HSK-C40	36	19	65	20	5	8	2,1	F3301K02.30	●
			HSK-C50	36	19	67	25	5	8	2,1	F3301K03.30	●
			HSK-C63	36	19	67	32	5	8	2,1	F3301K04.30	●
			HSK-C80	36	19	70	40	5	8	2,1	F3301K05.30	○
KSN 3	M4,5 - M24 (Nr.10 - 1")	EM 03	HSK-C40	53	31	99	20	8,5	15	2,8	F3303K02.30	●
			HSK-C50	53	31	101	25	8,5	15	2,8	F3303K03.30	●
			HSK-C63	53	31	101	32	8,5	15	2,8	F3303K04.30	●
			HSK-C80	53	31	104	40	8,5	15	2,8	F3303K05.30	○
			HSK-C100	53	31	104	50	8,5	15	2,8	F3303K06.30	○
KSN 4	M14 - M36 (9/16 - 1 3/8)	EM 04	HSK-C63	78	48	152	32	15	23,5	4,1	F3304K04.30	●
			HSK-C80	78	48	155	40	15	23,5	4,1	F3304K05.30	○
			HSK-C100	78	48	155	50	15	23,5	4,1	F3304K06.30	○
KSN 5	M22 - M48 (7/8 - 1 3/4)	EM 05	HSK-C80	96	60	189	40	16,5	25	5,7	F3305K05.30	○
			HSK-C100	96	60	189	50	16,5	25	5,7	F3305K06.30	○

Weitere Ausführungen auf Anfrage
Further designs upon request

Zubehör
Accessories



Schnellwechsel-Einsätze Typenreihe EM
Quick-change adapters EM series ▶▶ 755 - 778

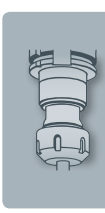

- Product Finder
- Soft-synchro
- Speed-synchro
- KSN**
- MQL MMS
- SFM
- SWITCH-MASTER
- GR, GR-S
- HF
- EM
- Zubehör Accessories
- Tech. Info

KSN DIN 1835 B+E

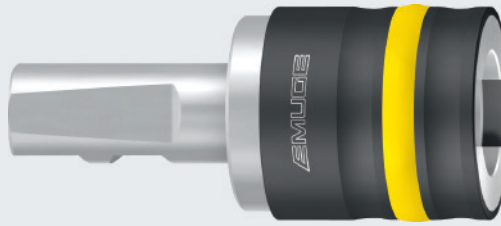

p_{max}
50bar
(700psi)

p_{max}
6bar
(85psi)

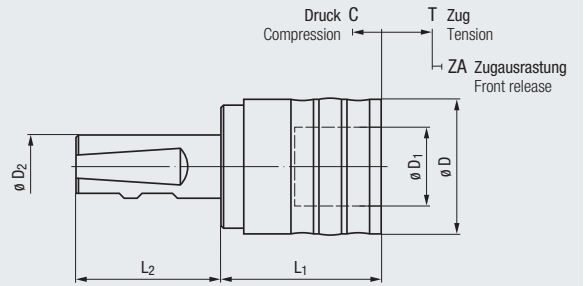

Einsatz auf CNC-Bearbeitungszentren, sonstigen Werkzeugmaschinen und Säulenbohrmaschinen
For use on CNC machining centres, other machine tools and pillar drilling machines

Typ Type			$\varnothing D_2$	$\varnothing D$	$\varnothing D_1$	L_1	L_2	C	T	ZA	Artikel-Nr. Article no.	
KSN 0	M1 - M10 (Nr.0 - 3/8)	EM 00	16	26	13	38	49	5	7,5	1,7	F3300G24	●
			20	26	13	38	51	5	7,5	1,7	F3300G25	●
KSN 1	M3 - M14 (Nr.4 - 9/16)	EM 01	16	36	19	39	49	5	8	2,1	F3301G24	●
			20	36	19	39	51	5	8	2,1	F3301G25	●
			25	36	19	39	57	5	8	2,1	F3301G26	●
KSN 3	M4,5 - M24 (Nr.10 - 1")	EM 03	25	53	31	63	57	8,5	15	2,8	F3303G26	●
			32	53	31	63	61	8,5	15	2,8	F3303G27	●
KSN 4	M14 - M36 (9/16 - 1 3/8)	EM 04	32	78	48	124	61	15	23,5	4,1	F3304G27	●
KSN 5	M22 - M48 (7/8 - 1 3/4)	EM 05	40	96	60	135,5	71	16,5	25	5,7	F3305G28	●

Weitere Ausführungen auf Anfrage
Further designs upon request

Zubehör Accessories

Schnellwechsel-Einsätze Typenreihe EM
Quick-change adapters EM series [» 755 - 778](#)

Adaptionsschäfte
Adapter shanks [» 780](#)

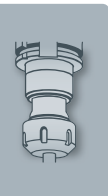



KSN
DIN 69871 A

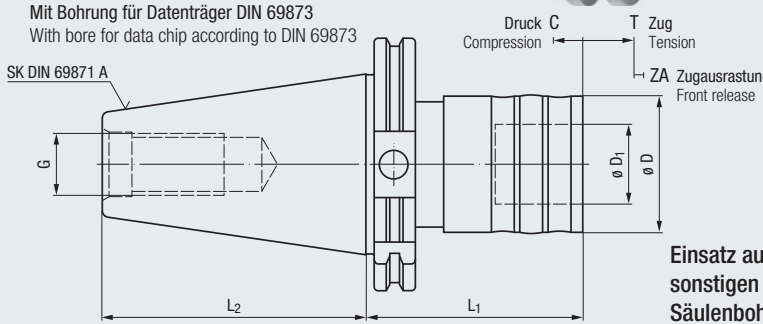

Einsatz auf CNC-Bearbeitungszentren,
sonstigen Werkzeugmaschinen und
Säulenbohrmaschinen

For use on CNC machining centres,
other machine tools and pillar
drilling machines

IKZ

MMS
MQL

p_{max}
50bar
(700psi)

p_{max}
6bar
(85psi)

C T

F

← →

- Product Finder
- Soft-synchro
- Speed-synchro
- KSN**
- MQL MMS
- SFM
- SWITCH-MASTER
- GR, GR-S
- HF
- EM
- Zubehör Accessories
- Tech. Info

Typ Type			SK	∅ D	∅ D ₁	L ₁	L ₂	G	C	T	ZA	Artikel-Nr. Article no.	
KSN 1	M3 - M14 (Nr.4 - 9/16)	EM 01	SK 40	36	19	60	68,4	M16	5	8	2,1	F3301651	●
			SK 50	36	19	60	101,75	M24	5	8	2,1	F3301653	●
KSN 3	M4,5 - M24 (Nr.10 - 1")	EM 03	SK 40	53	31	98	68,4	M16	8,5	15	2,8	F3303651	●
			SK 50	53	31	84	101,75	M24	8,5	15	2,8	F3303653	●
KSN 4	M14 - M36 (9/16 - 1 3/8)	EM 04	SK 40	78	48	150	68,4	M16	15	23,5	4,1	F3304651	●
			SK 50	78	48	139	101,75	M24	15	23,5	4,1	F3304653	●
KSN 5	M22 - M48 (7/8 - 1 3/4)	EM 05	SK 40	96	60	166	68,4	M16	16,5	25	5,7	F3305651	●
			SK 50	96	60	153	101,75	M24	16,5	25	5,7	F3305653	●

Weitere Ausführungen auf Anfrage
Further designs upon request

Zubehör
Accessories



Schnellwechsel-Einsätze Typenreihe EM
Quick-change adapters EM series ▶▶ 755 - 778

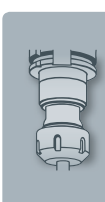

- Product Finder
- Soft-synchro
- Speed-synchro
- KSN**
- ML MMS
- SFM
- SWITCH-MASTER
- GR, GR-S
- HF
- EM
- Zubehör Accessories
- Tech. Info

KSN DIN 2080

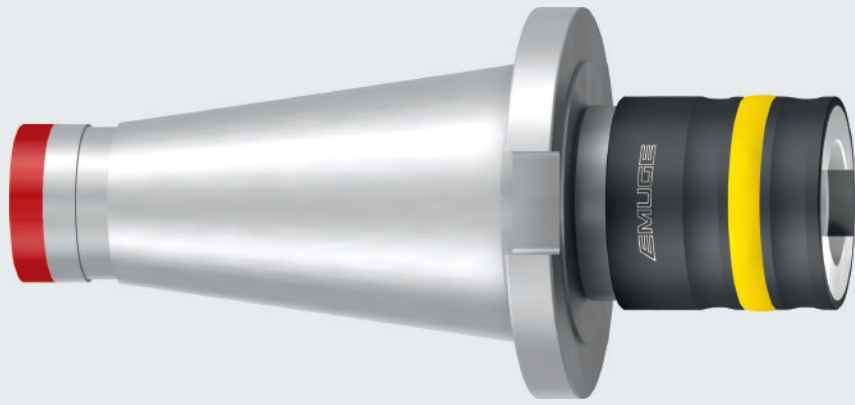

IKZ

MMS
MQL

p_{max}
50bar
(700psi)

p_{max}
6bar
(85psi)

C T

F

↔

[Image]

[Image]

[Image]

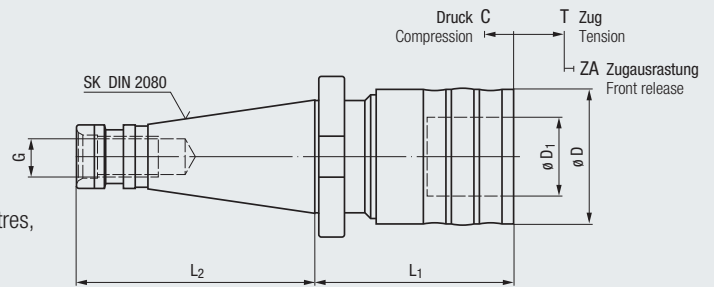

Einsatz auf CNC-Bearbeitungszentren, sonstigen Werkzeugmaschinen und Säulenbohrmaschinen

For use on CNC machining centres, other machine tools and pillar drilling machines

Typ Type			SK	ø D	ø D ₁	L ₁	L ₂	G	C	T	ZA	Artikel-Nr. Article no.	
KSN 1	M3 - M14 (Nr.4 - 9/16)	EM 01	SK 30 ¹⁾	36	19	73	68,4	M12	5	8	2,1	F3301540	●
			SK 40 ¹⁾	36	19	60,6	93,4	M16	5	8	2,1	F3301541	●
			SK 50 ¹⁾	36	19	55	126,8	M24	5	8	2,1	F3301543	●
KSN 3	M4,5 - M24 (Nr.10 - 1")	EM 03	SK 30	53	31	97	68,4	M12	8,5	15	2,8	F3303540	○
			SK 40 ¹⁾	53	31	84,6	93,4	M16	8,5	15	2,8	F3303541	●
			SK 50 ¹⁾	53	31	79	126,8	M24	8,5	15	2,8	F3303543	●
KSN 4	M14 - M36 (9/16 - 1 3/8)	EM 04	SK 40	78	48	143	93,4	M16	15	23,5	4,1	F3304541	●
			SK 50 ¹⁾	78	48	140	126,8	M24	15	23,5	4,1	F3304543	●
KSN 5	M22 - M48 (7/8 - 1 3/4)	EM 05	SK 40	96	60	157	93,4	M16	16,5	25	5,7	F3305541	●
			SK 50	96	60	144	126,8	M24	16,5	25	5,7	F3305543	●

¹⁾ Adaptierung über DIN 1835 B
Adaptation by DIN 1835 B

Weitere Ausführungen auf Anfrage
Further designs upon request

SK 40 und SK 50 sind mit Ringnut für MAHO und Deckel ausgestattet
SK 40 and SK 50 shanks are equipped with a ring groove for MAHO and Deckel

Zubehör Accessories

Schnellwechsel-Einsätze Typenreihe EM
Quick-change adapters EM series

▶▶ 755 - 778

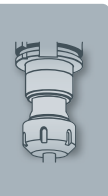

Informationen zur neuen EG-Maschinenrichtlinie 2006/42/EG, siehe Seite 656

Information regarding the new EC Machinery Directive 2006/42/EC, see page 656

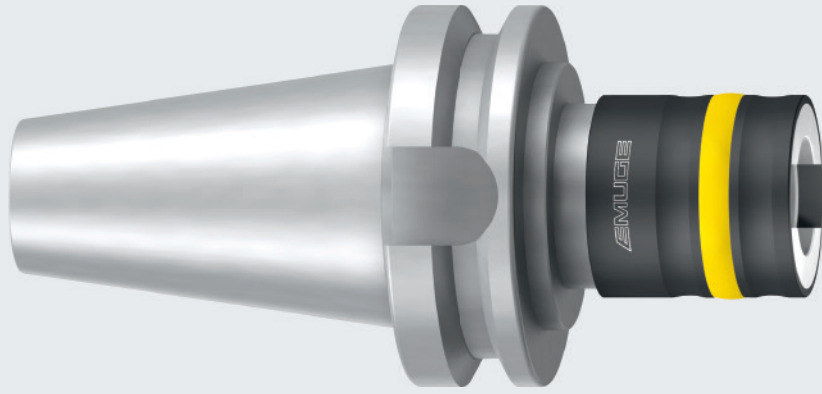

KSN
JIS B 6339
(MAS 403 BT)

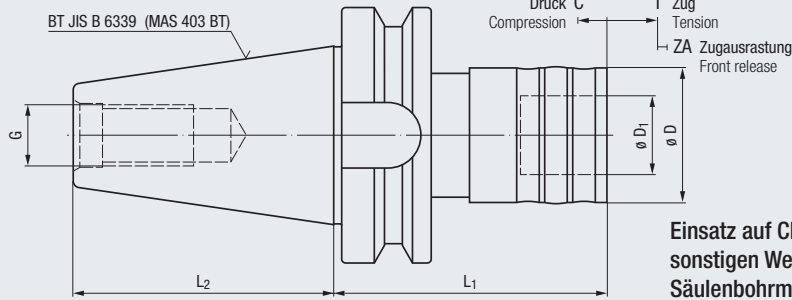
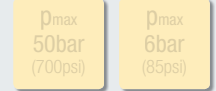

Einsatz auf CNC-Bearbeitungszentren,
sonstigen Werkzeugmaschinen und
Säulenbohrmaschinen

For use on CNC machining centres,
other machine tools and pillar
drilling machines

Typ Type			BT	ø D	ø D ₁	L ₁	L ₂	G	C	T	ZA	Artikel-Nr. Article no.	
KSN 1	M3 - M14 (Nr.4 - 9/16)	EM 01	BT 40 ¹⁾	36	19	74	65,4	M16	5	8	2,1	F3301891	●
			BT 50 ¹⁾	36	19	83	101,8	M24	5	8	2,1	F3301893	●
KSN 3	M4,5 - M24 (Nr.10 - 1")	EM 03	BT 40 ¹⁾	53	31	98	65,4	M16	8,5	15	2,8	F3303891	●
			BT 50 ¹⁾	53	31	107	101,8	M24	8,5	15	2,8	F3303893	●
KSN 4	M14 - M36 (9/16 - 1 3/8)	EM 04	BT 40	78	48	164	65,4	M16	15	23,5	4,1	F3304891	●
			BT 50 ¹⁾	78	48	168	101,8	M24	15	23,5	4,1	F3304893	●
KSN 5	M22 - M48 (7/8 - 1 3/4)	EM 05	BT 40	96	60	167,5	65,4	M16	16,5	25	5,7	F3305891	●
			BT 50	96	60	165,5	101,8	M24	16,5	25	5,7	F3305893	●

¹⁾ Adaptierung über DIN 1835 B
Adaptation by DIN 1835 B

Weitere Ausführungen auf Anfrage
Further designs upon request

Zubehör
Accessories



Schnellwechsel-Einsätze Typenreihe EM
Quick-change adapters EM series ▶▶ 755 - 778

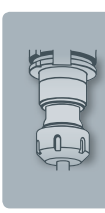

- Product Finder
- Soft-synchro
- Speed-synchro
- KSN**
- MQL MMS
- SFM
- SWITCH-MASTER
- GR, GR-S
- HF
- EM
- Zubehör Accessories
- Tech. Info

KSN DIN 228 B

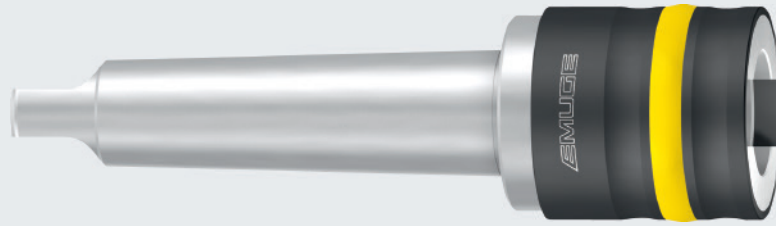

IKZ

MMS
MQL

p_{max}
50bar
(700psi)

p_{max}
6bar
(85psi)

C T

F

↔

EM

EM

EM

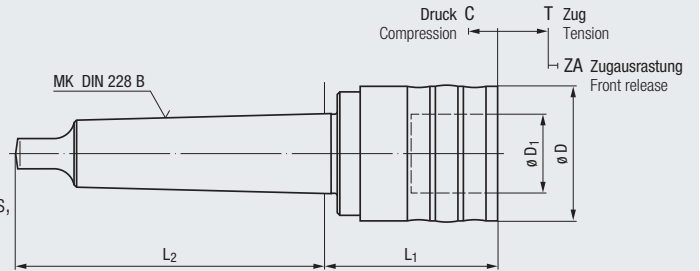

Einsatz auf CNC-Bearbeitungszentren, sonstigen Werkzeugmaschinen und Säulenbohrmaschinen

For use on CNC machining centres, other machine tools and pillar drilling machines

Typ Type			MK	∅ D	∅ D ₁	L ₁	L ₂	C	T	ZA	Artikel-Nr. Article no.	
KSN 0	M1 - M10 (Nr.0 - 3/8)	EM 00	MK 1	26	13	43,5	62	5	7,5	1,7	F3300101	●
			MK 2	26	13	45	75	5	7,5	1,7	F3300102	●
KSN 1	M3 - M14 (Nr.4 - 9/16)	EM 01	MK 2	36	19	47	75	5	8	2,1	F3301102	●
			MK 3	36	19	47	94	5	8	2,1	F3301103	●
KSN 3	M4,5 - M24 (Nr.10 - 1")	EM 03	MK 3	53	31	71	94	8,5	15	2,8	F3303103	●
			MK 4	53	31	72	117,5	8,5	15	2,8	F3303104	●
			MK 5	53	31	72,5	149,5	8,5	15	2,8	F3303105	●
KSN 4	M14 - M36 (9/16 - 1 3/8)	EM 04	MK 4	78	48	105	117,5	15	23,5	4,1	F3304104	●
			MK 5	78	48	105,5	149,5	15	23,5	4,1	F3304105	●
KSN 5	M22 - M48 (7/8 - 1 3/4)	EM 05	MK 5	96	60	116,5	149,5	16,5	25	5,7	F3305105	●
			MK 6	96	60	118,5	210	16,5	25	5,7	F3305106	●

Morsekegelschaft mit Anzugsgewinde nach DIN 228 A auf Anfrage
Morse taper shank with clamping thread acc. DIN 228 A upon request

Weitere Ausführungen auf Anfrage
Further designs upon request

Zubehör Accessories

Schnellwechsel-Einsätze Typenreihe EM
Quick-change adapters EM series

» 755 - 778

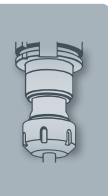

KSN
DIN 6327

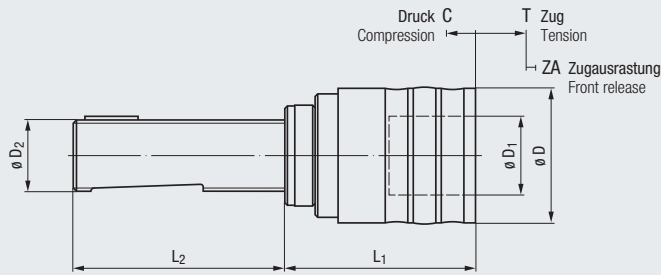
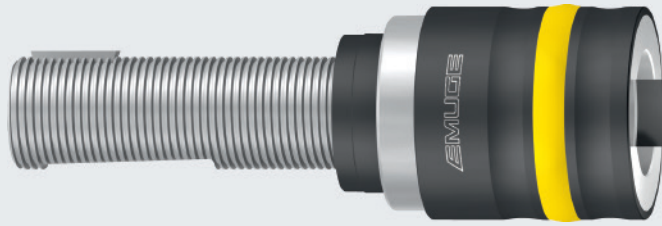

Einsatz auf CNC-Bearbeitungszentren,
sonstigen Werkzeugmaschinen und
Säulenbohrmaschinen

For use on CNC machining centres,
other machine tools and pillar
drilling machines

IKZ

MMS
MQL

p_{max}
50bar
(700psi)

p_{max}
6bar
(85psi)

C T

F

↔

- Product Finder
- Soft-synchro
- Speed-synchro
- KSN**
- MQL MMS
- SFM
- SWITCH-MASTER
- GR, GR-S
- HF
- EM
- Zubehör Accessories
- Tech. Info

Typ Type			ø D ₂	ø D	ø D ₁	L ₁	L ₂	C	T	ZA	Artikel-Nr. Article no.	
KSN 0	M1 - M10 (Nr.0 - 3/8)	EM 00	Tr 16 x 1,5	26	13	50	73	5	7,5	1,7	F3300213	●
			Tr 20 x 2	26	13	50	76	5	7,5	1,7	F3300214	●
KSN 1	M3 - M14 (Nr.4 - 9/16)	EM 01	Tr 16 x 1,5	36	19	52	73	5	8	2,1	F3301213	●
			Tr 20 x 2	36	19	52	76	5	8	2,1	F3301214	●
			Tr 28 x 2	36	19	52	83	5	8	2,1	F3301216	●
KSN 3	M4,5 - M24 (Nr.10 - 1")	EM 03	Tr 36 x 2	36	19	54	104	5	8	2,1	F3301218	●
			Tr 20 x 2	53	31	76	76	8,5	15	2,8	F3303214	●
			Tr 28 x 2	53	31	76	83	8,5	15	2,8	F3303216	●
KSN 4	M14 - M36 (9/16 - 1 3/8)	EM 04	Tr 36 x 2	53	31	78	104	8,5	15	2,8	F3303218	●
			Tr 28 x 2	78	48	109	83	15	23,5	4,1	F3304216	●
			Tr 36 x 2	78	48	111	104	15	23,5	4,1	F3304218	●
KSN 5	M22 - M48 (7/8 - 1 3/4)	EM 05	Tr 48 x 2	78	48	115	126	15	23,5	4,1	F3304219	●
			Tr 36 x 2	96	60	122	104	16,5	25	5,7	F3305218	●
			Tr 48 x 2	96	60	126	126	16,5	25	5,7	F3305219	●

Weitere Ausführungen auf Anfrage
Further designs upon request

Zubehör
Accessories



Schnellwechsel-Einsätze Typenreihe EM
Quick-change adapters EM series

» 755 - 778

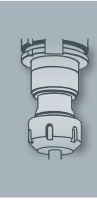

KSN

DIN ISO 10889
(VDI 3425)

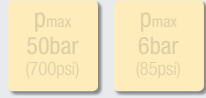
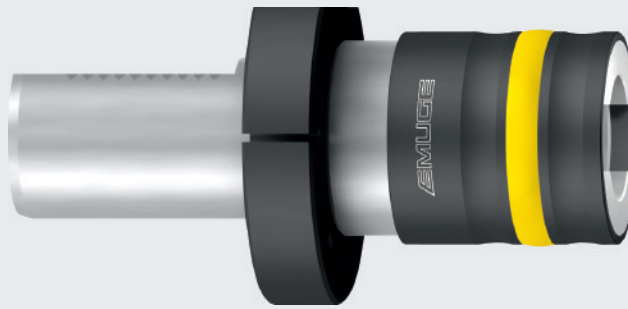

Mit Bohrung für Datenträger DIN 69873
With bore for data chip according to DIN 69873

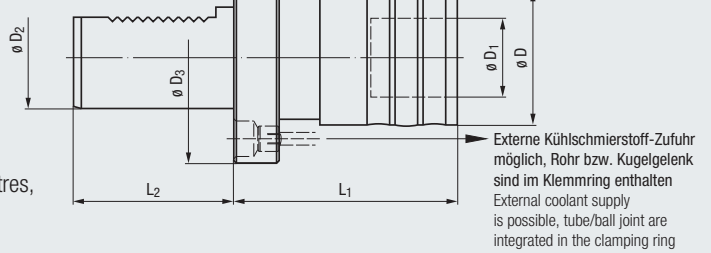

Einsatz auf CNC-Bearbeitungszentren, sonstigen Werkzeugmaschinen und Säulenbohrmaschinen

For use on CNC machining centres, other machine tools and pillar drilling machines

Typ Type			$\varnothing D_2$	$\varnothing D_3$	$\varnothing D$	$\varnothing D_1$	L_1	L_2	C	T	ZA	Artikel-Nr. Article no.	
KSN 1	M3 - M14 (Nr.4 - 9/16)	EM 01	20	50	36	19	57	40	5	8	2,1	F3301430	●
			30	68	36	19	57	55	5	8	2,1	F3301431	●
			40	83	36	19	57	63	5	8	2,1	F3301432	●
			50	98	36	19	57	78	5	8	2,1	F3301433	●
KSN 3	M4,5 - M24 (Nr.10 - 1")	EM 03	30	68	53	31	88	55	8,5	15	2,8	F3303431	●
			40	83	53	31	88	63	8,5	15	2,8	F3303432	●
			50	98	53	31	88	78	8,5	15	2,8	F3303433	●
KSN 4	M14 - M36 (9/16 - 1 3/8)	EM 04	40	83	78	48	123	63	15	23,5	4,1	F3304432	●
			50	98	78	48	123	78	15	23,5	4,1	F3304433	●
			60	123	78	48	123	94	15	23,5	4,1	F3304434	●
KSN 5	M22 - M48 (7/8 - 1 3/4)	EM 05	50	98	96	60	140	78	16,5	25	5,7	F3305433	●
			60	123	96	60	140	94	16,5	25	5,7	F3305434	●

Weitere Ausführungen auf Anfrage
Further designs upon request

Zubehör Accessories



Schnellwechsel-Einsätze Typenreihe EM
Quick-change adapters EM series ▶ 755 - 778



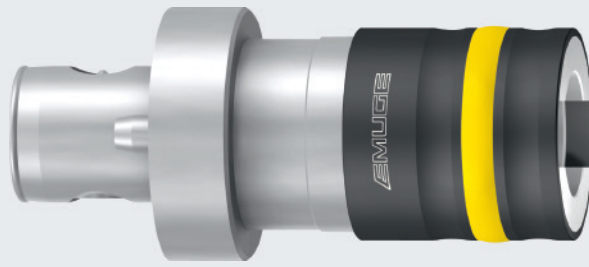

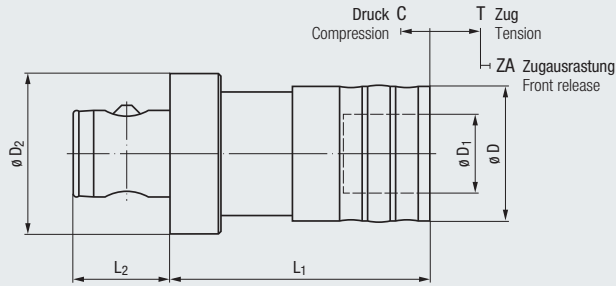

KSN
ABS®
(System KOMET)



Einsatz auf CNC-Bearbeitungszentren,
sonstigen Werkzeugmaschinen und
Säulenbohrmaschinen

For use on CNC machining centres,
other machine tools and pillar
drilling machines

Typ Type			$\varnothing D_2$	$\varnothing D$	$\varnothing D_1$	L_1	L_2	C	T	ZA	Artikel-Nr. Article no.	
KSN 1	M3 - M14 (Nr.4 - 9/16)	EM 01	ABS 32	36	19	72	23	5	8	2,1	F3301L01	●
			ABS 40	36	19	72	26	5	8	2,1	F3301L02	●
			ABS 50	36	19	72	31	5	8	2,1	F3301L03	●
			ABS 63	36	19	72	38	5	8	2,1	F3301L04	●
KSN 3	M4,5 - M24 (Nr.10 - 1")	EM 03	ABS 50	53	31	102	31	8,5	15	2,8	F3303L03	●
			ABS 63	53	31	102	38	8,5	15	2,8	F3303L04	●
KSN 4	M14 - M36 (9/16 - 1 3/8)	EM 04	ABS 63	78	48	155	38	15	23,5	4,1	F3304L04	●

Weitere Ausführungen auf Anfrage
Further designs upon request

Zubehör
Accessories



Schnellwechsel-Einsätze Typenreihe EM
Quick-change adapters EM series  755 - 778

- Product Finder
- Soft-synchro
- Speed-synchro
- KSN**
- MLL MMS
- SFM
- SWITCH-MASTER
- GR, GR-S
- HF
- EM
- Zubehör Accessories
- Tech. Info

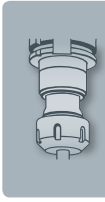

KSN/HD DIN 69893 A

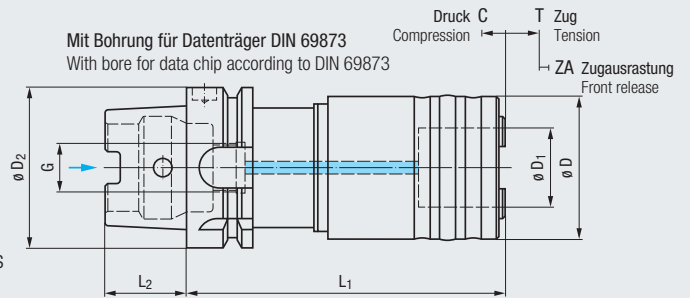
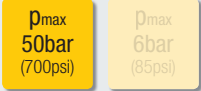
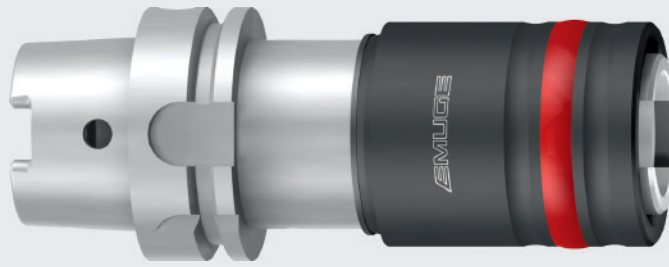

Einsatz auf CNC-Bearbeitungszentren und sonstigen Werkzeugmaschinen
For use on CNC machining centres and other machine tools

Typ Type			$\varnothing D_2$	$\varnothing D$	$\varnothing D_1$	L_1	L_2	G	C	T	ZA	Artikel-Nr. Article no.	
KSN 1/HD	M3 - M14 (Nr.4 - 9/16)	EM 01	HSK-A50	40	19	91	25	M16 x 1	5	7,5	2,5	F3101C03.1.30	●
			HSK-A63	40	19	93	32	M18 x 1	5	7,5	2,5	F3101C04.1.30	●
			HSK-A80	40	19	97	40	M20 x 1,5	5	7,5	2,5	F3101C05.1.30	○
			HSK-A100	40	19	98	50	M24 x 1,5	5	7,5	2,5	F3101C06.1.30	●
KSN 3/HD	M4,5 - M24 (Nr.10 - 1")	EM 03	HSK-A50	56	31	140	25	M16 x 1	7	10	3	F3103C03.1.30	●
			HSK-A63	56	31	130	32	M18 x 1	7	10	3	F3103C04.1.30	●
			HSK-A80	56	31	133	40	M20 x 1,5	7	10	3	F3103C05.1.30	●
			HSK-A100	56	31	135	50	M24 x 1,5	7	10	3	F3103C06.1.30	●

Weitere Ausführungen auf Anfrage
Further designs upon request

Zubehör Accessories



Schnellwechsel-Einsätze Typenreihe EM
Quick-change adapters EM series [» 755 - 778](#)



Kühlschmierstoffrohre und Schlüssel
Coolant tubes and wrenches [» 782 - 783](#)

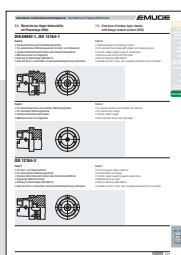

Übersicht der Kegelhohlschäfte
mit Plananlage (HSK)
siehe Seite 813

Overview of hollow taper shanks
with flange contact surface (HSK),
see page 813

KSN/HD
DIN 69893 C

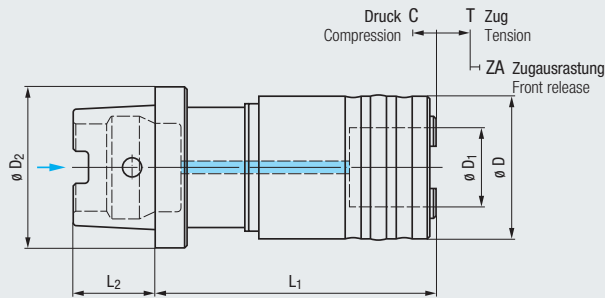
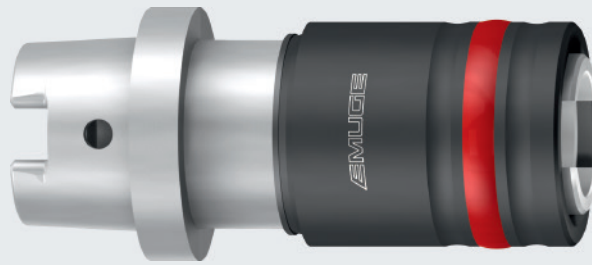

Einsatz auf CNC-Bearbeitungszentren
und sonstigen Werkzeugmaschinen

For use on CNC machining centres
and other machine tools

p_{max}
50bar
(700psi)

p_{max}
6bar
(85psi)

- Product Finder
- Soft-synchro
- Speed-synchro
- KSN**
- MQL MMS
- SFM
- SWITCH-MASTER
- GR, GR-S
- HF
- EM
- Zubehör Accessories
- Tech. Info

Typ Type			$\varnothing D_2$	$\varnothing D$	$\varnothing D_1$	L_1	L_2	C	T	ZA	Artikel-Nr. Article no.	
KSN 1/HD	M3 - M14 (Nr.4 - 9/16)	EM 01	HSK-C40	40	19	75	20	5	7,5	2,5	F3101K02.1.30	●
			HSK-C50	40	19	78	25	5	7,5	2,5	F3101K03.1.30	●
			HSK-C63	40	19	78	32	5	7,5	2,5	F3101K04.1.30	●
			HSK-C80	40	19	81	40	5	7,5	2,5	F3101K05.1.30	○
			HSK-C100	40	19	81	50	5	7,5	2,5	F3101K06.1.30	○
KSN 3/HD	M4,5 - M24 (Nr.10 - 1")	EM 03	HSK-C50	56	31	118	25	7	10	3	F3103K03.1.30	●
			HSK-C63	56	31	110	32	7	10	3	F3103K04.1.30	●
			HSK-C80	56	31	113	40	7	10	3	F3103K05.1.30	○
			HSK-C100	56	31	115	50	7	10	3	F3103K06.1.30	○

Weitere Ausführungen auf Anfrage
Further designs upon request

Zubehör
Accessories



Schnellwechsel-Einsätze Typenreihe EM
Quick-change adapters EM series **755 - 778**

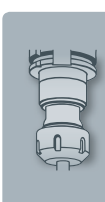

- Product Finder
- Soft-synchro
- Speed-synchro
- KSN**
- MQL MMS
- SFM
- SWITCH-MASTER
- GR, GR-S
- HF
- EM
- Zubehör Accessories
- Tech. Info

KSN/HD

ISO 26623-1

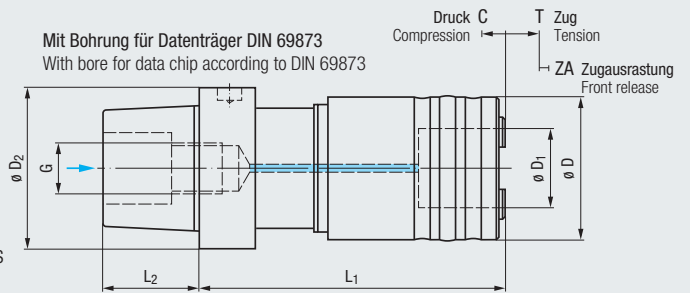
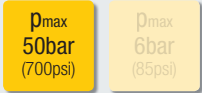

Einsatz auf CNC-Bearbeitungszentren und sonstigen Werkzeugmaschinen

For use on CNC machining centres and other machine tools

Typ Type			$\varnothing D_2$	$\varnothing D$	$\varnothing D_1$	L_1	L_2	G	C	T	ZA	Artikel-Nr. Article no.	
KSN 1/HD	M3 - M14 (Nr.4 - 9/16)	EM 01	PSC 63	40	19	86,5	38	M20 x 2	5	7,5	2,5	F3101T06.1	●
KSN 3/HD	M4,5 - M24 (Nr.10 - 1")	EM 03	PSC 63	56	31	120	38	M20 x 2	7	10	3	F3103T06.1	●

Weitere Ausführungen auf Anfrage
Further designs upon request

Zubehör Accessories



Schnellwechsel-Einsätze Typenreihe EM
Quick-change adapters EM series [» 755 - 778](#)

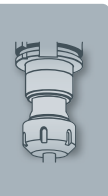

KSN/HD
DIN 1835 B+E

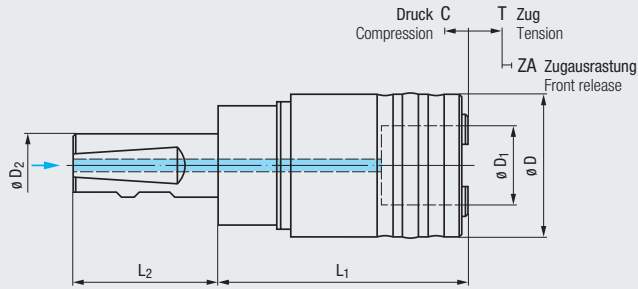

Einsatz auf CNC-Bearbeitungszentren
und sonstigen Werkzeugmaschinen

For use on CNC machining centres
and other machine tools

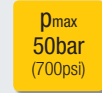

Product Finder

Soft-synchro

Speed-synchro

KSN

MQL MMS

SFM

SWITCH-MASTER



GR, GR-S

HF

EM

Zubehör Accessories

Tech. Info

Typ Type			$\varnothing D_2$	$\varnothing D$	$\varnothing D_1$	L_1	L_2	C	T	ZA	Artikel-Nr. Article no.	
KSN 1/HD	M3 - M14 (Nr.4 - 9/16)	EM 01	25	40	19	62	57	5	7,5	2,5	F3101G26.1	●
KSN 3/HD	M4,5 - M24 (Nr.10 - 1")	EM 03	25	56	31	98	57	7	10	3	F3103G26.1	●
KSN 4/HD	M14 - M36 (9/16 - 1 3/8)	EM 04	32	80	48	147	61	15	20	5	F3104G27.1	●

Weitere Ausführungen auf Anfrage
Further designs upon request

Zubehör
Accessories



Schnellwechsel-Einsätze Typenreihe EM
Quick-change adapters EM series **» 755 - 778**



Adaptionsschäfte
Adapter shanks **» 780**



KSN/HD

DIN 69871 AD
DIN 69871 B

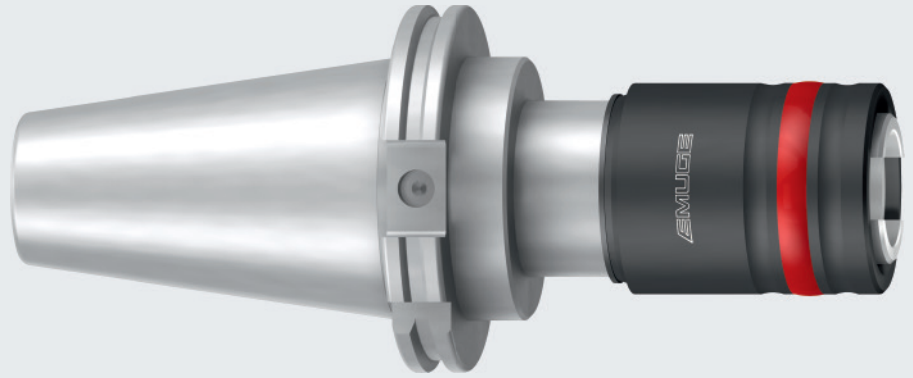

- Product Finder
- Soft-synchro
- Speed-synchro
- KSN**
- MQL MMS
- SFM
- SWITCH-MASTER
- GR, GR-S
- HF
- EM
- Zubehör Accessories
- Tech. Info

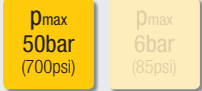

Einsatz auf CNC-Bearbeitungs-
zentren und sonstigen
Werkzeugmaschinen

For use on CNC machining
centres and other machine
tools

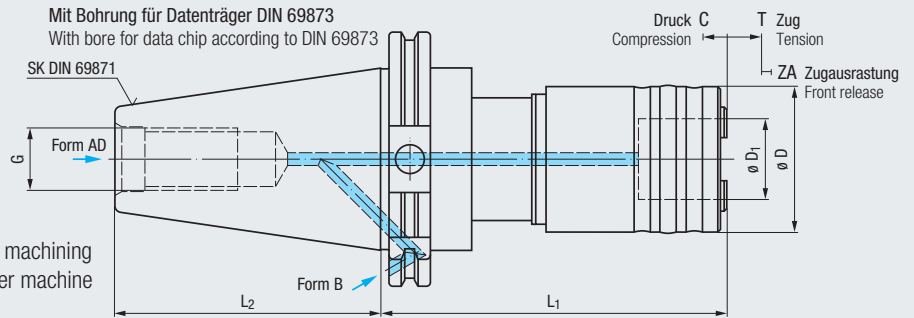

Typ Type			SK 1)	$\varnothing D$	$\varnothing D_1$	L_1	L_2	G	C	T	ZA	Artikel-Nr. Article no.	
KSN 1/HD	M3 - M14 (Nr.4 - 9/16)	EM 01	SK 40 AD	40	19	98	68,4	M16	5	7,5	2,5	F3101651.1	●
			SK 40 B	40	19	98	68,4	M16	5	7,5	2,5	F3101651.2	●
			SK 50 AD	40	19	98	101,75	M24	5	7,5	2,5	F3101653.1	●
			SK 50 B	40	19	98	101,75	M24	5	7,5	2,5	F3101653.2	●
KSN 3/HD	M4,5 - M24 (Nr.10 - 1")	EM 03	SK 40 AD	56	31	134	68,4	M16	7	10	3	F3103651.1	●
			SK 40 B	56	31	134	68,4	M16	7	10	3	F3103651.2	●
			SK 50 AD	56	31	134	101,75	M24	7	10	3	F3103653.1	●
			SK 50 B	56	31	134	101,75	M24	7	10	3	F3103653.2	●

1) Adaptierung über DIN 1835 B
Adaptation by DIN 1835 B

Weitere Ausführungen auf Anfrage
Further designs upon request

Zubehör Accessories



Schnellwechsel-Einsätze Typenreihe EM
Quick-change adapters EM series **755 - 778**

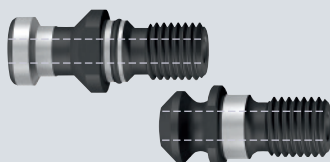

Anzugsbolzen für Steilkegelschäfte
siehe Seite 566

Pull studs for ISO taper shanks,
see page 566

KSN/HD
DIN 6327

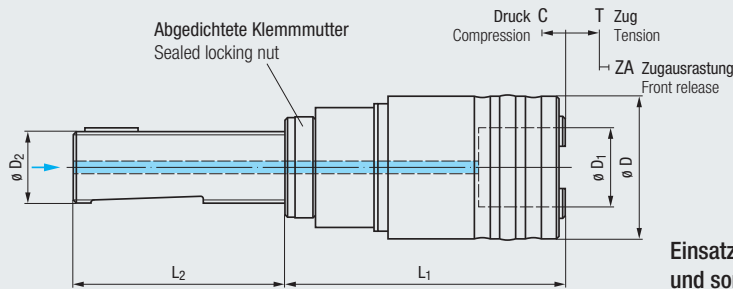
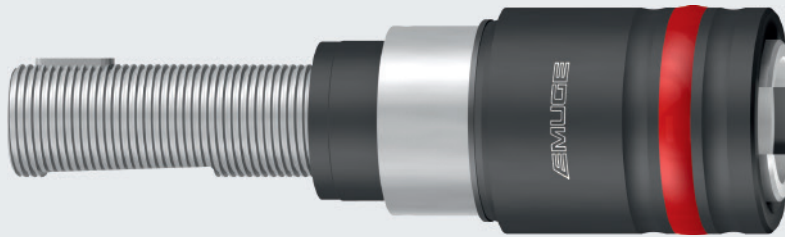

Einsatz auf CNC-Bearbeitungszentren
und sonstigen Werkzeugmaschinen

For use on CNC machining centres
and other machine tools

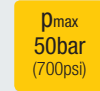
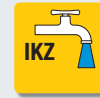

Typ Type			$\varnothing D_2$	$\varnothing D$	$\varnothing D_1$	L_1	L_2	C	T	ZA	Artikel-Nr. Article no.	
KSN 1/HD	M3 - M14 (Nr.4 - 9/16)	EM 01	Tr 20 x 2	40	19	79	71	5	7,5	2,5	F3101214.1	●
			Tr 28 x 2	40	19	80	77	5	7,5	2,5	F3101216.1	●
KSN 3/HD	M4,5 - M24 (Nr.10 - 1")	EM 03	Tr 28 x 2	56	31	116	77	7	10	3	F3103216.1	●
			Tr 36 x 2	56	31	118	98	7	10	3	F3103218.1	●

Weitere Ausführungen auf Anfrage
Further designs upon request

Zubehör
Accessories



Schnellwechsel-Einsätze Typenreihe EM
Quick-change adapters EM series ▶▶ 755 - 778

- Product Finder
- Soft-synchro
- Speed-synchro
- KSN**
- ML MMS
- SFM
- SWITCH-MASTER
- GR, GR-S
- HF
- EM
- Zubehör Accessories
- Tech. Info

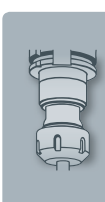

- Product Finder
- Soft-synchro
- Speed-synchro
- KSN**
- MQL MMS
- SFM
- SWITCH-MASTER
- GR, GR-S
- HF
- EM
- Zubehör Accessories
- Tech. Info

KSN/HD

DIN ISO 10889 (VDI 3425)

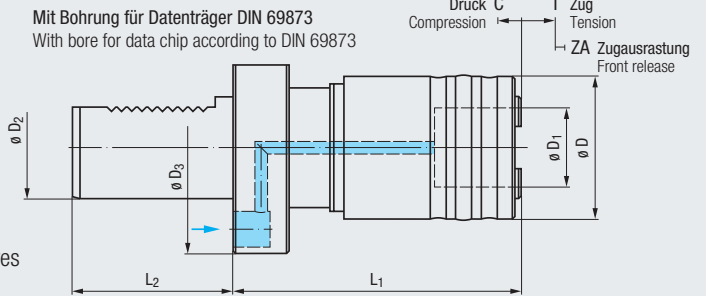
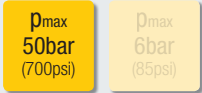
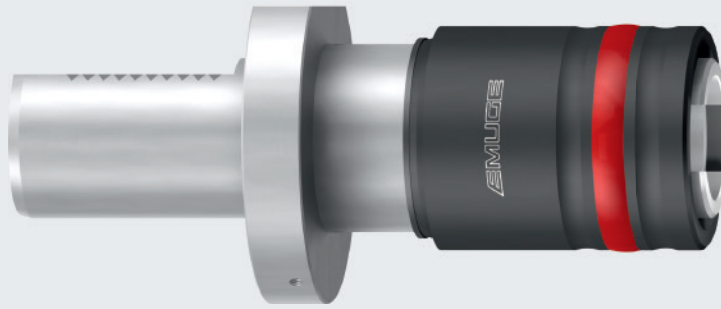

Einsatz auf CNC-Bearbeitungszentren und sonstigen Werkzeugmaschinen

For use on CNC machining centres and other machine tools

Typ Type			$\varnothing D_2$	$\varnothing D_3$	$\varnothing D$	$\varnothing D_1$	L_1	L_2	C	T	ZA	Artikel-Nr. Article no.	
KSN 1/HD	M3 - M14 (Nr.4 - 9/16)	EM 01	30	68	40	19	77	55	5	7,5	2,5	F3101431.1	●
			40	83	40	19	77	63	5	7,5	2,5	F3101432.1	●
			50	98	40	19	77	78	5	7,5	2,5	F3101433.1	○
KSN 3/HD	M4,5 - M24 (Nr.10 - 1")	EM 03	30	68	56	31	113	55	7	10	3	F3103431.1	●
			40	83	56	31	113	63	7	10	3	F3103432.1	●
			50	98	56	31	113	78	7	10	3	F3103433.1	●

Weitere Ausführungen auf Anfrage
Further designs upon request

Zubehör Accessories



Schnellwechsel-Einsätze Typenreihe EM
Quick-change adapters EM series ▶ 755 - 778

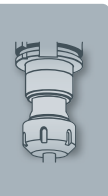



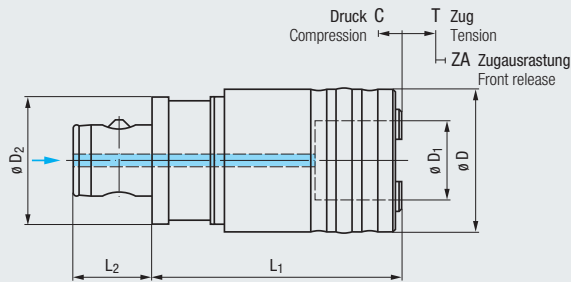
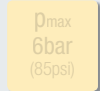
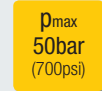

KSN/HD
ABS®
(System KOMET)



Einsatz auf CNC-Bearbeitungszentren
und sonstigen Werkzeugmaschinen

For use on CNC machining centres
and other machine tools

Typ Type			ø D ₂	ø D	ø D ₁	L ₁	L ₂	C	T	ZA	Artikel-Nr. Article no.	
KSN 1/HD	M3 - M14 (Nr.4 - 9/16)	EM 01	ABS 32	40	19	69	23	5	7,5	2,5	F3101L01.1	●
KSN 3/HD	M4,5 - M24 (Nr.10 - 1")	EM 03	ABS 50	56	31	98	31	7	10	3	F3103L03.1	●

Weitere Ausführungen auf Anfrage
Further designs upon request

Zubehör
Accessories



Schnellwechsel-Einsätze Typenreihe EM
Quick-change adapters EM series [» 755 - 778](#)

- Product Finder
- Soft-synchro
- Speed-synchro
- KSN**
- MQL MMS
- SFM
- SWITCH-MASTER
- GR, GR-S
- HF
- EM
- Zubehör Accessories
- Tech. Info

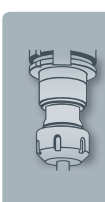

KSN/HD/ER

DIN 69893 A

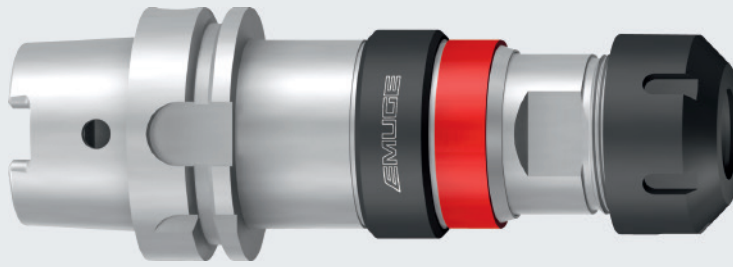

Mit Bohrung für Datenträger DIN 69873
With bore for data chip according to DIN 69873

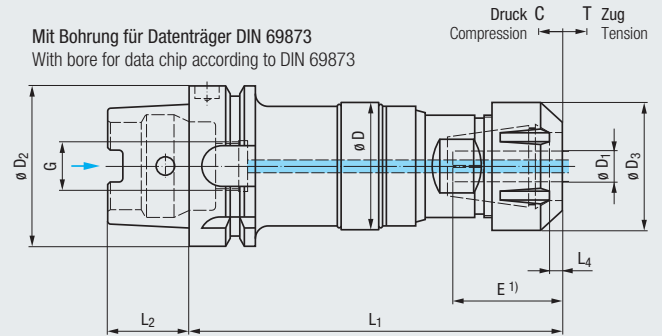

Einsatz auf CNC-Bearbeitungszentren und sonstigen Werkzeugmaschinen

For use on CNC machining centres and other machine tools

Typ Type		$\varnothing D_1$			$\varnothing D_2$	$\varnothing D$	$\varnothing D_3$	L_1	L_2	L_4	G	C	T	Artikel-Nr. Article no.	
KSN 1/HD/ER	M4 - M12 (Nr.8 - 7/16)	4,5 - 10	ER 20 (GB)	Hi-Q/ERMC 20	HSK-A50	38	28	114	25	5	M16 x 1	5	7,5	F3231C03.1	●
					HSK-A63	38	28	116	32	5	M18 x 1	5	7,5	F3231C04.1	●
					HSK-A80	38	28	120	40	5	M20 x 1,5	5	7,5	F3231C05.1	○
					HSK-A100	38	28	121	50	5	M24 x 1,5	5	7,5	F3231C06.1	●
KSN 3/HD/ER	M4 - M20 (Nr.8 - 3/4)	4,5 - 16	ER 32 (GB)	Hi-Q/ERC 32	HSK-A50	52	50	157	25	5	M16 x 1	7	10	F3233C03.1	○
					HSK-A63	52	50	147	32	5	M18 x 1	7	10	F3233C04.1	●
					HSK-A80	52	50	150	40	5	M20 x 1,5	7	10	F3233C05.1	○
					HSK-A100	52	50	152	50	5	M24 x 1,5	7	10	F3233C06.1	●

¹⁾ Einstecktiefen E siehe Seite 797
Clamping depths E, see page 797

Weitere Ausführungen auf Anfrage
Further designs upon request

Spannmutter für Dichtscheiben ist im Lieferumfang enthalten
Clamping nut for sealing disks is included in the delivery

Zubehör Accessories



Spannzangen Typ ER (GB)
Collets type ER (GB)

» 786 - 787



Dichtscheiben Typ DS/ER
Sealing disks type DS/ER

» 789



Spannschlüsselsatz
Set of clamping wrenches

» 794



Kühlschmierstoffrohre und Schlüssel
Coolant tubes and wrenches

» 782 - 783

KSN/HD/ER

DIN 69893 C

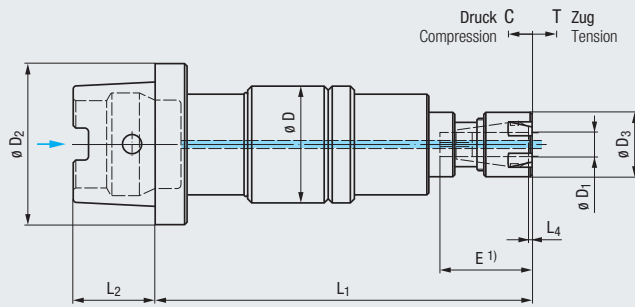



Einsatz auf CNC-Bearbeitungszentren
und sonstigen Werkzeugmaschinen

For use on CNC machining centres
and other machine tools



- Product Finder
- Soft-synchro
- Speed-synchro
- KSN**
- MQL MMS
- SFM
- SWITCH-MASTER
- GR, GR-S
- HF
- EM
- Zubehör Accessories
- Tech. Info

Typ Type		$\varnothing D_1$			$\varnothing D_2$	$\varnothing D$	$\varnothing D_3$	L_1 ER	L_1 ER-GB	L_2	L_4	C	T	Artikel-Nr. Article no.	
KSN 0/HD/ER	M2 - M8 (Nr.0 - Nr.6)	2,5 - 6	ER 11 (GB)	Hi-Q/ERM 11	HSK-C32	29	16	97,3	95,5	16	0,9	6	6	F3230K01.1	●
						29	16	97,3	95,5	20	0,9	6	6	F3230K02.1	●

1) Einstecktiefen E siehe Seite 797
Clamping depths E, see page 797

Weitere Ausführungen auf Anfrage
Further designs upon request

Spannmutter ohne integrierte Abdichtung ist im Lieferumfang enthalten
Clamping nut without integrated seal is included in the delivery

Zubehör Accessories



Spannzangen Typ ER (GB)
Collets type ER (GB)

» 786 - 787



Spannmutter mit integrierter Abdichtung Typ Hi-Q/ERM 11
Clamping nut with integrated seal, type Hi-Q/ERM 11

» 790



Spannschlüsselsatz
Set of clamping wrenches

» 794

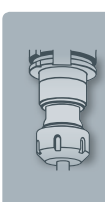

KSN/HD/ER

DIN 1835 B+E

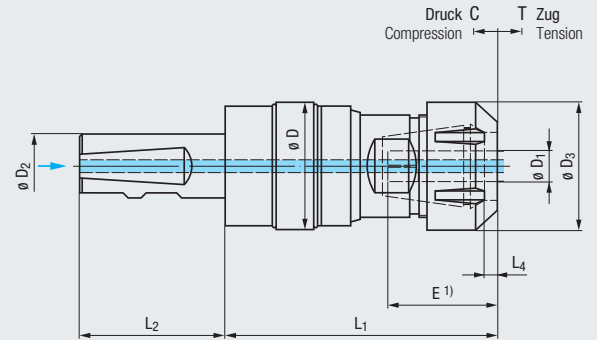

Einsatz auf CNC-Bearbeitungszentren und sonstigen Werkzeugmaschinen

For use on CNC machining centres and other machine tools

Typ Type		$\varnothing D_1$			$\varnothing D_2$	$\varnothing D$	$\varnothing D_3$	L_1	L_2	L_4	C	T	Artikel-Nr. Article no.	
KSN 1/HD/ER	M4 - M12 (Nr.8 - 7/16)	4,5 - 10	ER 20 (GB)	Hi-Q/ERMC 20	25	38	28	85	57	5	5	7,5	F3231G26.1	●
KSN 3/HD/ER	M4 - M20 (Nr.8 - 3/4)	4,5 - 16	ER 32 (GB)	Hi-Q/ERC 32	25	52	50	115	57	5	7	10	F3233G26.1	●

1) Einstecktiefen E siehe Seite 797
Clamping depths E, see page 797

Weitere Ausführungen auf Anfrage
Further designs upon request

Spannmutter für Dichtscheiben ist im Lieferumfang enthalten
Clamping nut for sealing disks is included in the delivery

Zubehör Accessories



Spannzangen Typ ER (GB)
Collets type ER (GB)

» 786 - 787



Dichtscheiben Typ DS/ER
Sealing disks type DS/ER

» 789



Spannschlüsselsatz
Set of clamping wrenches

» 794



Adaptionsschäfte
Adapter shanks

» 780

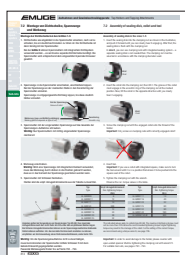

Montage von Dichtscheibe,
Spannzange und Werkzeug
siehe Seite 812

Assembly of sealing disk,
collet and tool,
see page 812

KSN/HD/PGR

DIN 69893 A

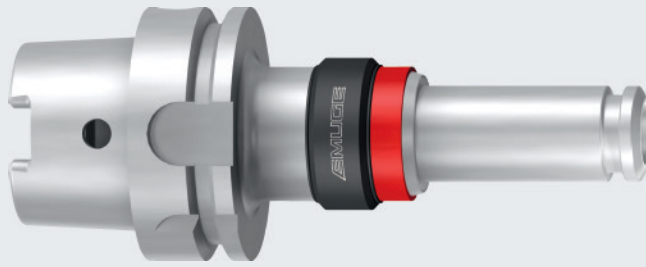

Mit Bohrung für Datenträger DIN 69873
With bore for data chip according to DIN 69873

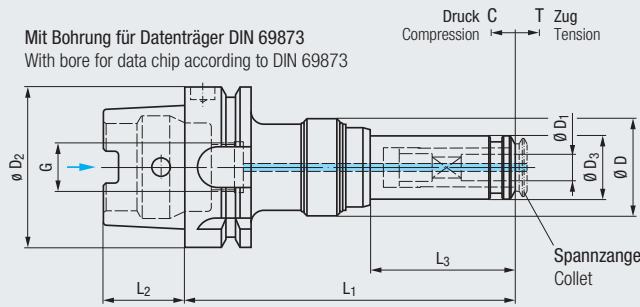

Einsatz auf CNC-Bearbeitungszentren
und sonstigen Werkzeugmaschinen

For use on CNC machining centres
and other machine tools



Product Finder

Soft-synchro

Speed-synchro

KSN

MQL MMS

SFM

SWITCH-MASTER

GR, GR-S

HF

EM

Zubehör Accessories

Tech. Info

Typ Type		$\varnothing D_1$		$\varnothing D_2$	$\varnothing D$	$\varnothing D_3$	L_1	L_2	L_3	G	C	T	Artikel-Nr. Article no.	
KSN 1/HD/PGR	M4 - M12 (Nr.8 - 7/16)	4,5 - 10	PGR 15 GB	HSK-A50	38	24	124	25	55	M16 x 1	5	7,5	F3241C03.1	●
				HSK-A63	38	24	126	32	55	M18 x 1	5	7,5	F3241C04.1	●
				HSK-A80	38	24	130	40	55	M20 x 1,5	5	7,5	F3241C05.1	○
				HSK-A100	38	24	131	50	55	M24 x 1,5	5	7,5	F3241C06.1	○
KSN 3/HD/PGR	M8 - M20 (5/16 - 3/4)	8 - 16	PGR 25 GB	HSK-A50	52	40	170	25	66,5	M16 x 1	7	10	F3243C03.1	●
				HSK-A63	52	40	160	32	66,5	M18 x 1	7	10	F3243C04.1	●
				HSK-A80	52	40	163	40	66,5	M20 x 1,5	7	10	F3243C05.1	●
				HSK-A100	52	40	165	50	66,5	M24 x 1,5	7	10	F3243C06.1	●

Weitere Ausführungen auf Anfrage
Further designs upon request

Zubehör Accessories



Spannzangen Typ PGR-GB
Collets type PGR-GB

» 796



Kühlschmierstoffrohre und Schlüssel
Coolant tubes and wrenches

» 782 - 783



- Product Finder
- Soft-synchro
- Speed-synchro
- KSN**
- MQL MMS
- SFM
- SWITCH-MASTER
- GR, GR-S
- HF
- EM
- Zubehör Accessories
- Tech. Info

KSN/HD/PGR

DIN 1835 B+E





IKZ



MMS
MQL

ρ_{max}
50bar
(700psi)

ρ_{max}
6bar
(85psi)



C T



F









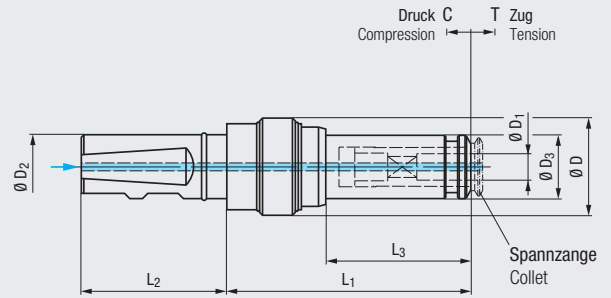



Einsatz auf CNC-Bearbeitungszentren und sonstigen Werkzeugmaschinen
For use on CNC machining centres and other machine tools

Typ Type		$\varnothing D_1$		$\varnothing D_2$	$\varnothing D$	$\varnothing D_3$	L_1	L_2	L_3	C	T	Artikel-Nr. Article no.	
KSN 1/HD/PGR	M4 - M12 (Nr.8 - 7/16)	4,5 - 10	PGR 15 GB	25	38	24	95	57	55	5	7,5	F3241G26.1	●
KSN 3/HD/PGR	M8 - M20 (5/16 - 3/4)	8 - 16	PGR 25 GB	25	52	40	128	57	66,5	7	10	F3243G26.1	●

Weitere Ausführungen auf Anfrage
Further designs upon request

Zubehör Accessories

 Spannzangen Typ PGR-GB
Collets type PGR-GB ▶▶ 796

 Adaptionsschäfte
Adapter shanks ▶▶ 780

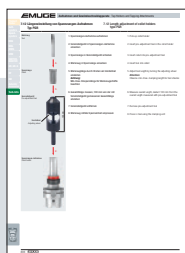

Längeneinstellung von
Spannzangen-Aufnahmen Typ PGR
siehe Seite 836

Length adjustment of
collet holders type PGR,
see page 836

KSN/Synchro

DIN 69893 A

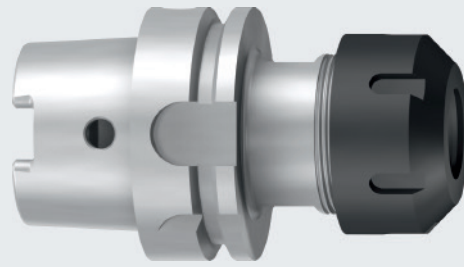

Mit Bohrung für Datenträger DIN 69873
With bore for data chip according to DIN 69873

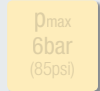
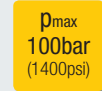
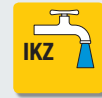
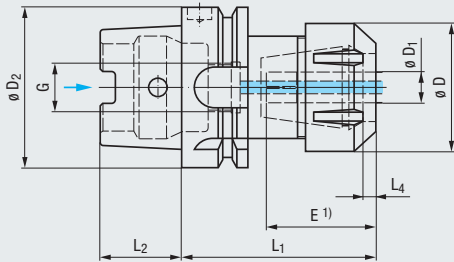

Product Finder

Soft-synchro

Speed-synchro

KSN

MQL MMS

SFM

SWITCH-MASTER

GR, GR-S

HF

EM

Zubehör Accessories

Tech. Info

Typ Type		$\varnothing D_1$			$\varnothing D_2$	$\varnothing D$	L_1	L_2	L_4	G	Artikel-Nr. Article no.	
KSN 1/ Synchro	M4 - M12 (Nr.8 - 1/2)	4,5 - 10	ER 20 (GB)	Hi-Q/ERC 20	HSK-A50	34	68	25	5	M16 x 1	F3131C03.1.30	●
					HSK-A63	34	68	32	5	M18 x 1	F3131C04.1.30	●
					HSK-A100	34	74	50	5	M24 x 1,5	F3131C06.1.30	●
KSN 3/ Synchro	M4 - M20 (Nr.8 - 3/4)	4,5 - 16	ER 32 (GB)	Hi-Q/ERC 32	HSK-A50	50	76	25	5	M16 x 1	F3133C03.1.30	●
					HSK-A63	50	76	32	5	M18 x 1	F3133C04.1.30	●
					HSK-A100	50	84	50	5	M24 x 1,5	F3133C06.1.30	●
KSN 4/ Synchro	M10 - M30 (3/8 - 1 1/4)	7 - 22	ER 40 (GB)	Hi-Q/ERC 40	HSK-A63	63	80	32	5	M18 x 1	F3134C04.1.30	○
					HSK-A100	63	91	50	5	M24 x 1,5	F3134C06.1.30	●

¹⁾ Einstecktiefen E siehe Seite 797
Clamping depths E, see page 797

Weitere Ausführungen auf Anfrage
Further designs upon request

Spannmutter für Dichtscheiben ist im Lieferumfang enthalten
Clamping nut for sealing disks is included in the delivery

Zubehör Accessories



Spannzangen Typ ER (GB)
Collets type ER (GB)

» 786 - 787



Dichtscheiben Typ DS/ER
Sealing disks type DS/ER

» 789



Spannschlüssel
Clamping wrench

» 794



Kühlschmierstoffrohre und Schlüssel
Coolant tubes and wrenches

» 782 - 783



- Product Finder
- Soft-synchro
- Speed-synchro
- KSN**
- MQL MMS
- SFM
- SWITCH-MASTER
- GR, GR-S
- HF
- EM
- Zubehör Accessories
- Tech. Info

KSN/Synchro

DIN 1835 B+E

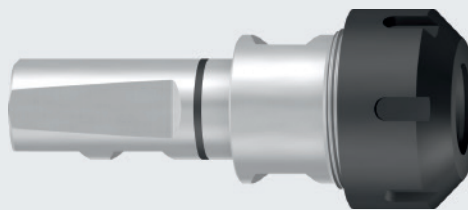

IKZ

MMS MQL

p_{max}
100bar
(1400psi)

p_{max}
6bar
(85psi)

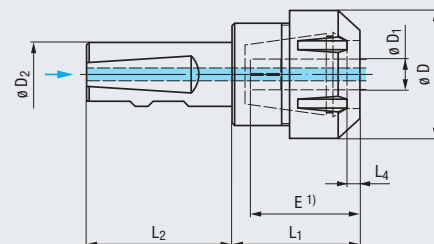

Typ Type		$\varnothing D_1$			$\varnothing D_2$	$\varnothing D$	L_1	L_2	L_4	Artikel-Nr. Article no.	
KSN 1/ Synchro	M4 - M12 (Nr.8 - 1/2)	4,5 - 10	ER 20 (GB)	Hi-Q/ERC 20	25	34	42	57	5	F3131G26.1.24	●
KSN 3/ Synchro	M4 - M20 (Nr.8 - 3/4)	4,5 - 16	ER 32 (GB)	Hi-Q/ERC 32	25	50	56	57	5	F3133G26.1.24	●
KSN 4/ Synchro	M10 - M30 (3/8 - 1 1/4)	7 - 22	ER 40 (GB)	Hi-Q/ERC 40	25	63	65	57	5	F3134G26.1.24	●

1) Einstecktiefen E siehe Seite 797
Clamping depths E, see page 797

Weitere Ausführungen auf Anfrage
Further designs upon request

Spannmutter für Dichtscheiben ist im Lieferumfang enthalten
Clamping nut for sealing disks is included in the delivery

Zubehör Accessories

- Spannzangen Typ ER (GB)
Collets type ER (GB)
▶▶ 786 - 787
- Dichtscheiben Typ DS/ER
Sealing disks type DS/ER
▶▶ 789
- Spannschlüssel
Clamping wrench
▶▶ 794
- Adaptionsschäfte
Adapter shanks
▶▶ 780

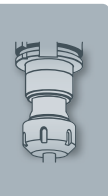

KSN/Synchro

DIN 69871 AD
DIN 69871 B

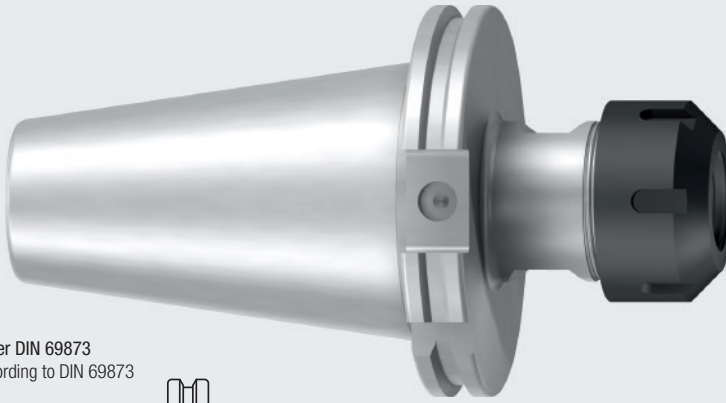

Mit Bohrung für Datenträger DIN 69873
With bore for data chip according to DIN 69873

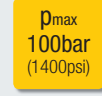
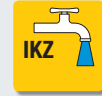
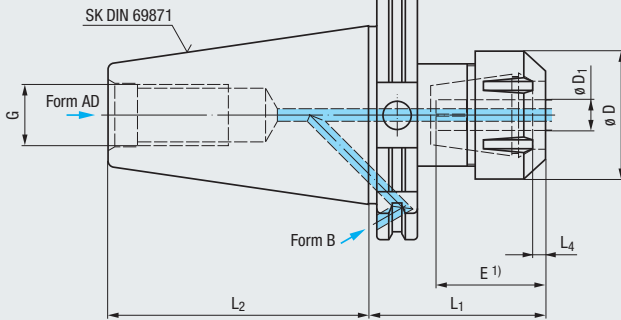

Product Finder

Soft-synchro

Speed-synchro

KSN

MQL MMS

SFM

SWITCH-MASTER

GR, GR-S

HF

EM

Zubehör Accessories

Tech. Info

Typ Type		$\varnothing D_1$		SK	$\varnothing D$	L ₁	L ₂	L ₄	G	Artikel-Nr. Article no.		
KSN 0/ Synchro	M1 - M10 (Nr.1 - 5/16)	2,5 - 7	ER 11 (GB)	Hi-Q/ER 11	SK 40 AD	19	58	68,4	—	M16	F3130651.1	●
					SK 40 B	19	58	68,4	—	M16	F3130651.2	○
					SK 50 AD	19	58	101,75	—	M24	F3130653.1	●
					SK 50 B	19	58	101,75	—	M24	F3130653.2	○
KSN 1/ Synchro	M4 - M12 (Nr.8 - 1/2)	4,5 - 10	ER 20 (GB)	Hi-Q/ERC 20	SK 40 AD	34	68	68,4	5	M16	F3131651.1.24	●
					SK 40 B	34	68	68,4	5	M16	F3131651.2.24	●
					SK 50 AD	34	68	101,75	5	M24	F3131653.1.24	●
					SK 50 B	34	68	101,75	5	M24	F3131653.2.24	●
KSN 3/ Synchro	M4 - M20 (Nr.8 - 3/4)	4,5 - 16	ER 32 (GB)	Hi-Q/ERC 32	SK 40 AD	50	76	68,4	5	M16	F3133651.1.24	●
					SK 40 B	50	76	68,4	5	M16	F3133651.2.24	●
					SK 50 AD	50	76	101,75	5	M24	F3133653.1.24	●
					SK 50 B	50	76	101,75	5	M24	F3133653.2.24	●
KSN 4/ Synchro	M10 - M30 (3/8 - 1 1/4)	7 - 22	ER 40 (GB)	Hi-Q/ERC 40	SK 40 AD	63	85	68,4	5	M16	F3134651.1.24	●
					SK 40 B	63	85	68,4	5	M16	F3134651.2.24	●
					SK 50 AD	63	85	101,75	5	M24	F3134653.1.24	●
					SK 50 B	63	85	101,75	5	M24	F3134653.2.24	●

1) Einstecktiepen E siehe Seite 797
Clamping depths E, see page 797

Weitere Ausführungen auf Anfrage
Further designs upon request

KSN 0/Synchro

Spannmutter ohne integrierte Abdichtung ist im Lieferumfang enthalten
Clamping nut without integrated seal is included in the delivery

KSN 1-4/Synchro

Spannmutter für Dichtscheiben ist im Lieferumfang enthalten
Clamping nut for sealing disks is included in the delivery

Zubehör

Accessories



Spannzangen Typ ER (GB)
Collets type ER (GB)

» 786 - 787



Spannmutter mit integrierter Abdichtung Typ Hi-Q/ERC 11
Clamping nut with integrated seal, type Hi-Q/ERC 11

» 791



Dichtscheiben Typ DS/ER
Sealing disks type DS/ER

» 789



Spannschlüssel
Clamping wrench

» 794



- Product Finder
- Soft-synchro
- Speed-synchro
- KSN
- MQL MMS**
- SFM
- SWITCH-MASTER
- GR, GR-S
- HF
- EM
- Zubehör Accessories
- Tech. Info

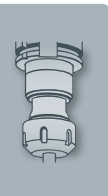
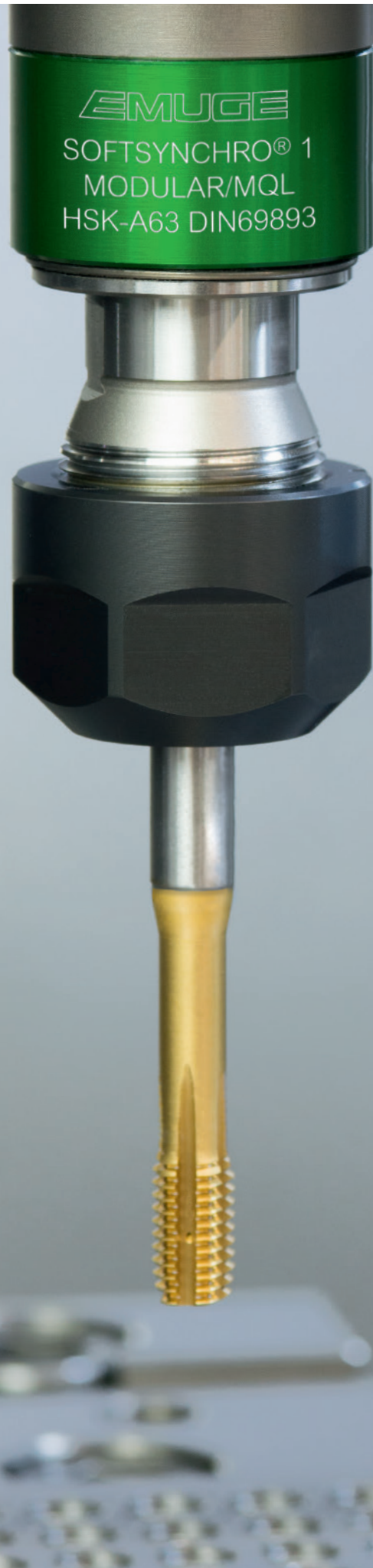

Product
FinderSoft-
synchroSpeed-
synchro

KSN

MQL
MMS

SFM

SWITCH-
MASTER

GR, GR-S

HF

EM

Zubehör
Accessories

Tech. Info

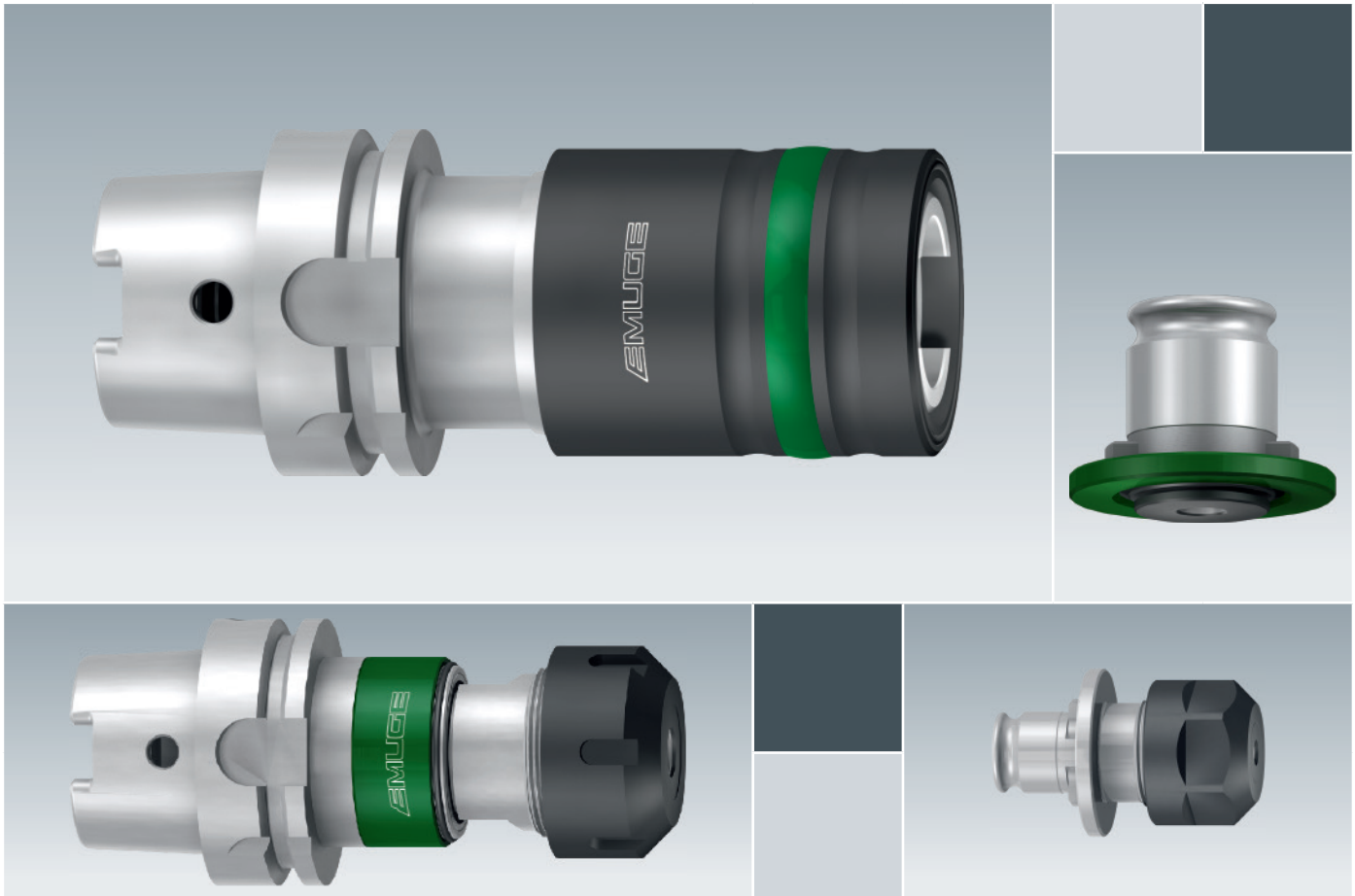

Typenreihen mit Minimalmengenschmierung Minimum Quantity Lubrication Series

Einsatz auf Maschinen mit Minimalmengenschmierung (MMS)

Strömungsoptimierte Übergabe des MMS-Mediums von der Maschinenspindel zum Gewindewerkzeug.

Application on machines with minimum-quantity lubrication (MQL)

Flow-optimised transfer of the MQL medium from machine spindle to threading tool.



Softsynchro®/MMS

DIN 69893 A

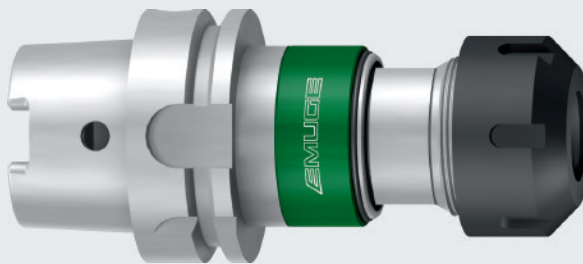

IKZ

MMS
MQL

MQL
1

p_{max}
50bar
(700psi)

p_{max}
6bar
(85psi)

Soft

F

Mit Bohrung für Datenträger DIN 69873
With bore for data chip according to DIN 69873

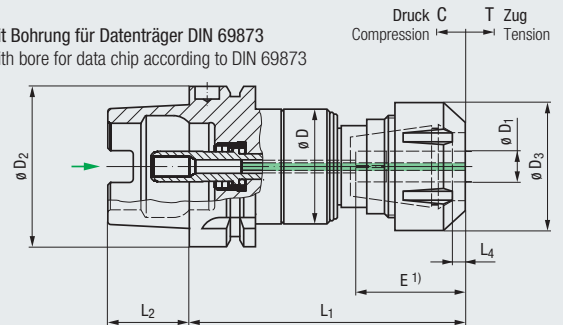

Einsatz auf Maschinen mit Synchronspindel For use on machines with synchronous spindle

Typ Type		$\varnothing D_1$			$\varnothing D_2$	$\varnothing D$	$\varnothing D_3$	L_1	L_2	L_4	C	T	Artikel-Nr. Article no.		
Softsynchro® 1/MMS	M4,5 - M10	6 - 8	ER 20 (GB)	Hi-Q/ERC 20	$\varnothing D_2$	HSK-A50	34	34	93,5	25	5	0,5	0,5	F3491C03.1.68	●
						HSK-A63	34	34	95,5	32	5	0,5	0,5	F3491C04.1.68	●
						HSK-A100	34	34	102	50	5	0,5	0,5	F3491C06.1.68	●
	M10 - M12	9 - 10				HSK-A50	34	34	93,5	25	5	0,5	0,5	F3491C03.1	●
						HSK-A63	34	34	95,5	32	5	0,5	0,5	F3491C04.1	●
						HSK-A100	34	34	102	50	5	0,5	0,5	F3491C06.1	●
Softsynchro® 3/MMS	M10 - M20	9 - 16	ER 32 (GB)	Hi-Q/ERC 32	$\varnothing D_2$	HSK-A50	45	50	116,3	25	5	0,5	0,5	F3493C03.1	●
						HSK-A63	45	50	108,8	32	5	0,5	0,5	F3493C04.1	●
						HSK-A100	45	50	115,3	50	5	0,5	0,5	F3493C06.1	●

1) Einstecktiefen E siehe Seite 797
Clamping depths E, see page 797

Weitere Ausführungen auf Anfrage
Further designs upon request

Das Kühlschmierstoffrohr ist im Schaft enthalten und darf nicht demontiert werden, da sonst die Funktion der MMS-Übergabe nicht mehr gewährleistet ist!
The coolant tube is integrated into the shank and must not be disassembled, otherwise the function of the MQL transfer is no longer warranted!

MMS-Übergabe passend zu DIN 69090-4 und vielen Werknormen
MQL supply according to DIN 69090-4 and many internal standards

Spannmutter für Dichtscheiben ist im Lieferumfang enthalten
Clamping nut for sealing disks is included in the delivery

Zubehör Accessories



Spannzangen Typ ER (GB)
Collets type ER (GB)

» 786 - 787



Dichtscheiben Typ DS/ER
Sealing disks type DS/ER

» 789



Spann Schlüsselset
Set of clamping wrenches

» 793



Montagevorrichtung
Assembly device

» 793



Drehmomentschlüssel TORCO-FIX
Torque wrenches TORCO-FIX

» 795

Softsynchro®/MMS

DIN 69893 A

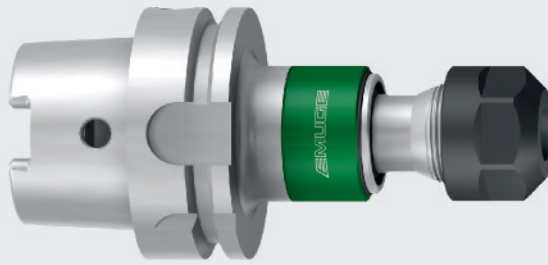

mit Bohrung für Datenträger DIN 69873
with bore for data chip according to DIN 69873

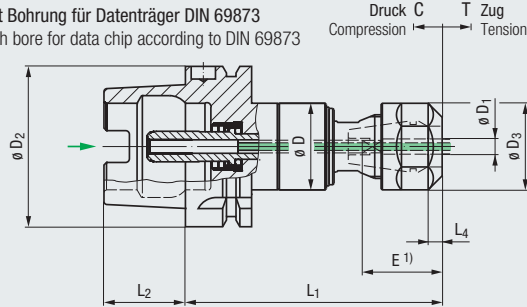

IKZ

MMS MQL

MQL 2

p_{max} 50bar (700psi)

p_{max} 6bar (85psi)

C T Soft

F

↔

Einsatz auf Maschinen mit Synchronspindel

For use on machines with synchronous spindle

Typ Type		$\varnothing D_1$			$\varnothing D_2$	$\varnothing D$	$\varnothing D_3$	L_1	L_2	L_4	C	T	Artikel-Nr. Article no.	
Softsynchro® 1/MMS	M4,5 - M12	6 - 10	ER 20 (GB)	Hi-Q/ERC 20	HSK-A50	34	34	93,5	25	5	0,5	0,5	F3511C03.1	●
					HSK-A63	34	34	95,5	32	5	0,5	0,5	F3511C04.1	●
					HSK-A100	34	34	102	50	5	0,5	0,5	F3511C06.1	●

1) Einstecktiefen E siehe Seite 797
Clamping depths E, see page 797

Weitere Ausführungen auf Anfrage
Further designs upon request

Das Kühlschmierstoffrohr ist im Schaft enthalten und darf nicht demontiert werden, da sonst die Funktion der MMS-Übergabe nicht mehr gewährleistet ist!
The coolant tube is integrated into the shank and must not be disassembled, otherwise the function of the MQL transfer is no longer warranted!

MMS-Übergabe passend zu DIN 69090-4 und vielen Werknormen
MQL supply according to DIN 69090-4 and many internal standards

Spannmutter für Dichtscheiben ist im Lieferumfang enthalten
Clamping nut for sealing disks is included in the delivery

Zubehör

Accessories



Spannzangen Typ ER (GB)
Collets type ER (GB)

» 786 - 787



Dichtscheiben Typ DS/ER
Sealing disks type DS/ER

» 789



Spannschlüsselsatz
Set of clamping wrenches

» 793



Montagevorrichtung
Assembly device

» 793



Drehmomentschlüssel TORCO-FIX
Torque wrenches TORCO-FIX

» 795



Softsynchro®/MMS

≈ DIN 69893 C 2)

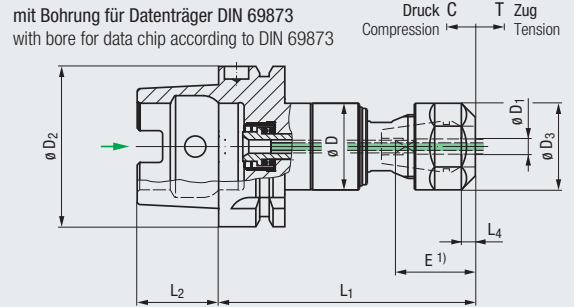
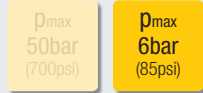
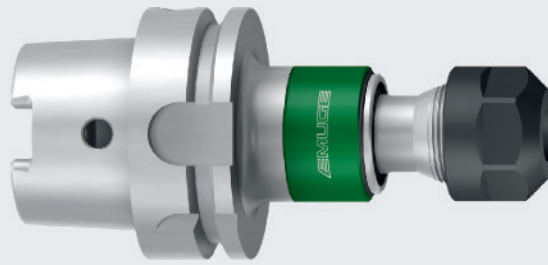

Einsatz auf Maschinen mit Synchronspindel For use on machines with synchronous spindle

Typ Type		$\varnothing D_1$			$\varnothing D_2$	$\varnothing D$	$\varnothing D_3$	L_1	L_2	L_4	C	T	Artikel-Nr. Article no.	
Softsynchro® 1/MMS	M4,5 - M10	6 - 8	ER 20 (GB)	Hi-Q/ERC 20	HSK-A63	34	34	95,5	32	5	0,5	0,5	F3491C04.1.5268	●
	M10 - M12	9 - 10			HSK-A63	34	34	95,5	32	5	0,5	0,5	F3491C04.1.52	●

1) Einstecktiefen E siehe Seite 797
Clamping depths E, see page 797

Weitere Ausführungen auf Anfrage
Further designs upon request

2) Außenkontur entspricht DIN 69893 A, Innenkontur nach DIN 69893 C
Outside contour acc. DIN 69893 A, inside contour acc. DIN 69893 C

Das Kühlschmierstoffrohr ist im Schaft enthalten und darf nicht demontiert werden, da sonst die Funktion der MMS-Übergabe nicht mehr gewährleistet ist!
The coolant tube is integrated into the shank and must not be disassembled, otherwise the function of the MQL transfer is no longer warranted!

MMS-Übergabe passend zu DIN 69090-4 und vielen Werknormen
MQL supply according to DIN 69090-4 and many internal standards

Spannmutter für Dichtscheiben ist im Lieferumfang enthalten
Clamping nut for sealing disks is included in the delivery

Zubehör Accessories



Spannzangen Typ ER (GB)
Collets type ER (GB) → 786 - 787



Dichtscheiben Typ DS/ER
Sealing disks type DS/ER → 789



Spann Schlüsselset
Set of clamping wrenches → 793



Montagevorrichtung
Assembly device → 793



Drehmomentschlüssel TORCO-FIX
Torque wrenches TORCO-FIX → 795



Softsynchro® Modular/MQL

DIN 69893 A

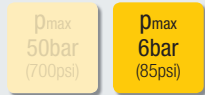
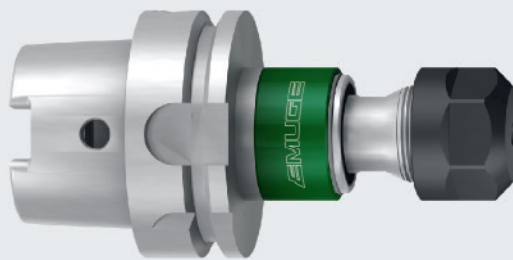

Mit Bohrung für Datenträger DIN 69873
With bore for data chip according to DIN 69873

Druck C T Zug
Compression Tension

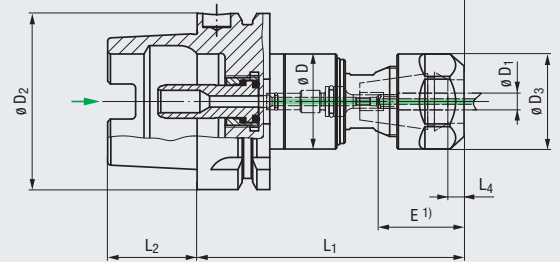

Einsatz auf Maschinen mit Synchronspindel For use on machines with synchronous spindle

new	Typ Type	ø D ₁	Werkzeugkegel Tool taper	ø D ₂	ø D	ø D ₃	L ₁	L ₂	L ₄	C	T	Artikel-Nr. Article no.				
Softsynchro® 1 Modular/MQL	M4,5 - M10	6 / 7	Innenkegel Internal taper 60°	ER 20 (GB)	Hi-Q/ERC 20	HSK-A40	34	34	89,5	20	5	0,5	0,5	F3551C02.53.I01	●	
						HSK-A63	34	34	95,5	32	5	0,5	0,5	F3551C04.53.I01	●	
						HSK-A100	34	34	102	50	5	0,5	0,5	F3551C06.53.I01	●	
	M8, M9, M11, M12	8 / 9	Innenkegel Internal taper 60°	ER 20 (GB)	Hi-Q/ERC 20	HSK-A40	34	34	89,5	20	5	0,5	0,5	F3551C02.53.I02	●	
						HSK-A63	34	34	95,5	32	5	0,5	0,5	F3551C04.53.I02	●	
						HSK-A100	34	34	102	50	5	0,5	0,5	F3551C06.53.I02	●	
	M10	10	Innenkegel Internal taper 60°	ER 20 (GB)	Hi-Q/ERC 20	HSK-A40	34	34	89,5	20	5	0,5	0,5	F3551C02.53.I03	●	
						HSK-A63	34	34	95,5	32	5	0,5	0,5	F3551C04.53.I03	●	
						HSK-A100	34	34	102	50	5	0,5	0,5	F3551C06.53.I03	●	
	M4,5 - M6 M8	6	Außenkegel External taper 90°	ER 20 (GB)	Hi-Q/ERC 20	HSK-A40	34	34	89,5	20	5	0,5	0,5	F3551C02.53.A04	●	
						HSK-A63	34	34	95,5	32	5	0,5	0,5	F3551C04.53.A04	●	
						HSK-A100	34	34	102	50	5	0,5	0,5	F3551C06.53.A04	●	
		M7, M10				7	HSK-A40	34	34	89,5	20	5	0,5	0,5	F3551C02.53.A05	●
							HSK-A63	34	34	95,5	32	5	0,5	0,5	F3551C04.53.A05	●
							HSK-A100	34	34	102	50	5	0,5	0,5	F3551C06.53.A05	●
		M8				8	HSK-A40	34	34	89,5	20	5	0,5	0,5	F3551C02.53.A06	●
							HSK-A63	34	34	95,5	32	5	0,5	0,5	F3551C04.53.A06	●
							HSK-A100	34	34	102	50	5	0,5	0,5	F3551C06.53.A06	●
		M12				9	HSK-A40	34	34	89,5	20	5	0,5	0,5	F3551C02.53.A07	●
							HSK-A63	34	34	95,5	32	5	0,5	0,5	F3551C04.53.A07	●
HSK-A100							34	34	102	50	5	0,5	0,5	F3551C06.53.A07	●	
M10	10	HSK-A40	34	34	89,5	20	5	0,5	0,5	F3551C02.53.A08	●					
		HSK-A63	34	34	95,5	32	5	0,5	0,5	F3551C04.53.A08	●					
		HSK-A100	34	34	102	50	5	0,5	0,5	F3551C06.53.A08	●					

1) Einstecktiefen E siehe Seite 797
Clamping depths E, see page 797

Külschmierstoffrohr, Längeneinstellschraube sowie Spannmutter für Dichtscheiben sind im Lieferumfang enthalten
Coolant tube, length adjustment screw as well as clamping nut for sealing disks are included in the delivery

MMS-Übergabe passend zu DIN 69090-4 und vielen Werknormen
MQL supply according to DIN 69090-4 and many internal standards



Detaillierte Informationen zu
Softsynchro® Modular
siehe Seite 821 - 822

Detailed information
regarding Softsynchro® Modular
see page 821 - 822

Softsynchro® Modular/MQL

DIN 69893 A

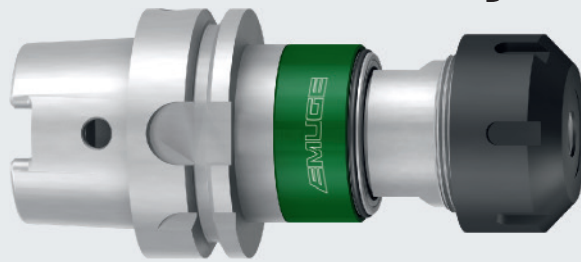

Mit Bohrung für Datenträger DIN 69873
With bore for data chip according to DIN 69873

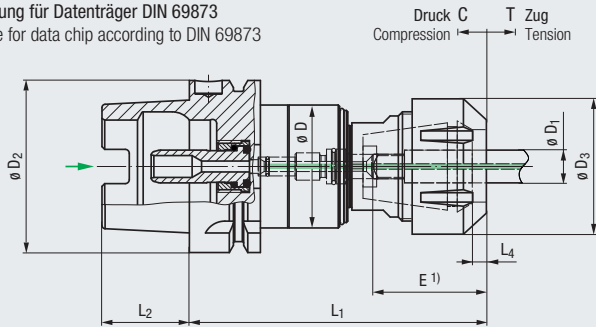

IKZ

MMS
MQL

MQL
1

p_{max}
50bar
(700psi)

p_{max}
6bar
(85psi)

C T
Soft

F

L+ 2 mm

[Icon]

[Icon]

[Icon]

Einsatz auf Maschinen
mit Synchronspindel

For use on machines
with synchronous spindle

new	Typ Type	$\varnothing D_1$	Werkzeugkegel Tool taper	$\varnothing D_2$	$\varnothing D$	$\varnothing D_3$	L_1	L_2	L_4	C	T	Artikel-Nr. Article no.					
Softsynchro® 3 Modular/MQL	M12	9	Innenkegel Internal taper 60° 	ER 32 (GB)	Hi-Q/ERC 32	HSK-A63	45	50	108,8	32	5	0,5	0,5	F3553C04.53.I01	●		
																F3553C06.53.I01	●
	M10 - M16	10 - 12				HSK-A63	45	50	108,8	32	5	0,5	0,5	F3553C04.53.I02	●		
						HSK-A100	50	50	115,3	50	5	0,5	0,5	F3553C06.53.I02	●		
	M18 - M20	14 - 16				HSK-A63	45	50	108,8	32	5	0,5	0,5	F3553C04.53.I03	●		
						HSK-A100	50	50	115,3	50	5	0,5	0,5	F3553C06.53.I03	●		
	M12	9	Außenkegel External taper 90° 	ER 32 (GB)	Hi-Q/ERC 32	HSK-A63	45	50	108,8	32	5	0,5	0,5	F3553C04.53.A04	●		
						HSK-A100	50	50	115,3	50	5	0,5	0,5	F3553C06.53.A04	●		
	M10	10				HSK-A63	45	50	108,8	32	5	0,5	0,5	F3553C04.53.A05	●		
						HSK-A100	50	50	115,3	50	5	0,5	0,5	F3553C06.53.A05	●		
	M14 - M16	11 - 12				HSK-A63	45	50	108,8	32	5	0,5	0,5	F3553C04.53.A06	●		
						HSK-A100	50	50	115,3	50	5	0,5	0,5	F3553C06.53.A06	●		
	M18	14	HSK-A63	45	50	108,8	32	5	0,5	0,5	F3553C04.53.A07	●					
			HSK-A100	50	50	115,3	50	5	0,5	0,5	F3553C06.53.A07	●					
	M20	16	HSK-A63	45	50	108,8	32	5	0,5	0,5	F3553C04.53.A08	●					
			HSK-A100	50	50	115,3	50	5	0,5	0,5	F3553C06.53.A08	●					

Zubehör Accessories

Spannzangen Typ ER (GB)
Collets type ER (GB) ▶▶ 786 - 787

Dichtscheiben Typ DS/ER
Sealing disks type DS/ER ▶▶ 789

Längeneinstellschrauben
Length adjustment screws ▶▶ 784

Spannschlüsselsatz
Set of clamping wrenches ▶▶ 793

Montagevorrichtung
Assembly device ▶▶ 793

Drehmomentschlüssel TORCO-FIX
Torque wrenches TORCO-FIX ▶▶ 795

Kühlschmierstoffrohre und Schlüssel
Coolant tubes and wrenches ▶▶ 782 - 783

● = Lagerwerkzeug, siehe Preisliste · Stock tool, see price list
○ = Kurzfristig lieferbar, Preis auf Anfrage · Available on short notice, price upon inquiry

Softsynchro® Modular/MQL

DIN 69893 A

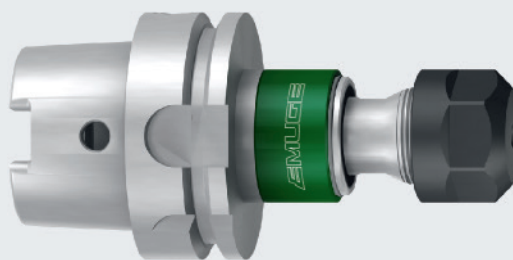

Mit Bohrung für Datenträger DIN 69873
With bore for data chip according to DIN 69873

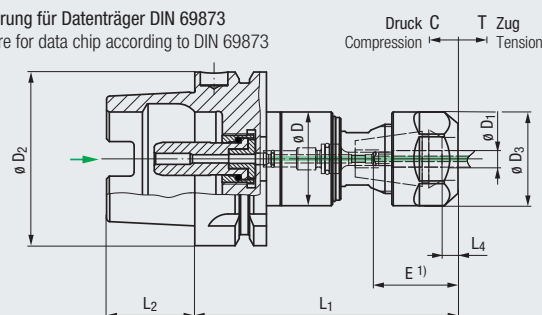

Einsatz auf Maschinen mit Synchronspindel For use on machines with synchronous spindle

new														Artikel-Nr. Article no.		
Typ Type		ø D ₁	Werkzeugkegel Tool taper			ø D ₂	ø D	ø D ₃	L ₁	L ₂	L ₄	C	T			
Softsynchro® 1 Modular/MQL	M4,5 - M10	6 / 7	Innenkegel Internal taper 60° 	ER 20 (GB)	Hi-Q/ERC 20	HSK-A40	34	34	89,5	20	5	0,5	0,5	F3551C02.54.I01	●	
						HSK-A63	34	34	95,5	32	5	0,5	0,5	F3551C04.54.I01	●	
						HSK-A100	34	34	102	50	5	0,5	0,5	F3551C06.54.I01	●	
	M8, M9, M11, M12	8 / 9		ER 20 (GB)	Hi-Q/ERC 20	HSK-A40	34	34	89,5	20	5	0,5	0,5	F3551C02.54.I02	●	
						HSK-A63	34	34	95,5	32	5	0,5	0,5	F3551C04.54.I02	●	
						HSK-A100	34	34	102	50	5	0,5	0,5	F3551C06.54.I02	●	
	M10	10		ER 20 (GB)	Hi-Q/ERC 20	HSK-A40	34	34	89,5	20	5	0,5	0,5	F3551C02.54.I03	●	
						HSK-A63	34	34	95,5	32	5	0,5	0,5	F3551C04.54.I03	●	
						HSK-A100	34	34	102	50	5	0,5	0,5	F3551C06.54.I03	●	
	Softsynchro® 1 Modular/MQL	M4,5 - M6 M8	6	Außenkegel External taper 90° 	ER 20 (GB)	Hi-Q/ERC 20	HSK-A40	34	34	89,5	20	5	0,5	0,5	F3551C02.54.A04	●
							HSK-A63	34	34	95,5	32	5	0,5	0,5	F3551C04.54.A04	●
							HSK-A100	34	34	102	50	5	0,5	0,5	F3551C06.54.A04	●
		M7, M10	7		ER 20 (GB)	Hi-Q/ERC 20	HSK-A40	34	34	89,5	20	5	0,5	0,5	F3551C02.54.A05	●
							HSK-A63	34	34	95,5	32	5	0,5	0,5	F3551C04.54.A05	●
							HSK-A100	34	34	102	50	5	0,5	0,5	F3551C06.54.A05	●
		M8	8		ER 20 (GB)	Hi-Q/ERC 20	HSK-A40	34	34	89,5	20	5	0,5	0,5	F3551C02.54.A06	●
							HSK-A63	34	34	95,5	32	5	0,5	0,5	F3551C04.54.A06	●
							HSK-A100	34	34	102	50	5	0,5	0,5	F3551C06.54.A06	●
		M12	9		ER 20 (GB)	Hi-Q/ERC 20	HSK-A40	34	34	89,5	20	5	0,5	0,5	F3551C02.54.A07	●
							HSK-A63	34	34	95,5	32	5	0,5	0,5	F3551C04.54.A07	●
HSK-A100							34	34	102	50	5	0,5	0,5	F3551C06.54.A07	●	
M10	10		ER 20 (GB)	Hi-Q/ERC 20	HSK-A40	34	34	89,5	20	5	0,5	0,5	F3551C02.54.A08	●		
					HSK-A63	34	34	95,5	32	5	0,5	0,5	F3551C04.54.A08	●		
					HSK-A100	34	34	102	50	5	0,5	0,5	F3551C06.54.A08	●		

1) Einstecktiefen E siehe Seite 797
Clamping depths E, see page 797

Külschmierstoffrohr, Längeneinstellschraube sowie Spannmutter für Dichtscheiben sind im Lieferumfang enthalten
Coolant tube, length adjustment screw as well as clamping nut for sealing disks are included in the delivery

MMS-Übergabe passend zu DIN 69090-4 und vielen Werknormen
MQL supply according to DIN 69090-4 and many internal standards



Detaillierte Informationen zu
Softsynchro® Modular
siehe Seite 821 - 822

Detailed information
regarding Softsynchro® Modular
see page 821 - 822

Softsynchro® Modular/MQL

DIN 69893 A

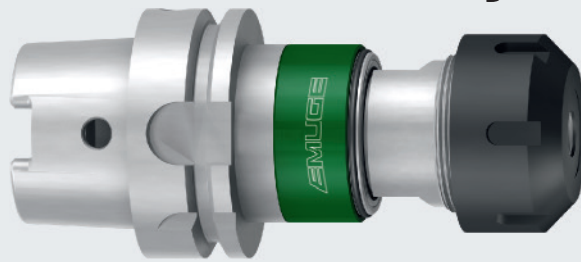

Mit Bohrung für Datenträger DIN 69873
With bore for data chip according to DIN 69873

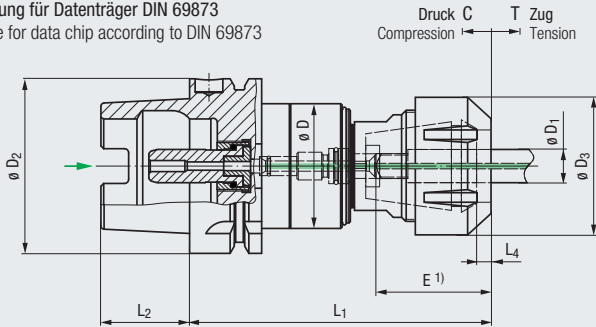

IKZ

MMS
MQL

MQL
2

p_{max}
50bar
(700psi)

p_{max}
6bar
(85psi)

C T
Soft

F

L+ 2 mm

[Icon: Collet]

[Icon: Cap]

Einsatz auf Maschinen mit Synchronspindel For use on machines with synchronous spindle

new	Typ Type	$\varnothing D_1$	Werkzeugkegel Tool taper	$\varnothing D_2$	$\varnothing D$	$\varnothing D_3$	L_1	L_2	L_4	C	T	Artikel-Nr. Article no.			
Softsynchro® 3 Modular/MQL	M12	9	Innenkegel Internal taper 60° 	ER 32 (GB)	Hi-Q/ERC 32	HSK-A63	45	50	108,8	32	5	0,5	0,5	F3553C04.54.101	●
	HSK-A100	50				50	115,3	50	5	0,5	0,5	F3553C06.54.101	●		
	M10 - M16	10 - 12				HSK-A63	45	50	108,8	32	5	0,5	0,5	F3553C04.54.102	●
	HSK-A100	50				50	115,3	50	5	0,5	0,5	F3553C06.54.102	●		
	M18 - M20	14 - 16	HSK-A63	45	50	108,8	32	5	0,5	0,5	F3553C04.54.103	●			
	HSK-A100	50	50	115,3	50	5	0,5	0,5	F3553C06.54.103	●					
	M12	9	Außenkegel External taper 90° 	ER 32 (GB)	Hi-Q/ERC 32	HSK-A63	45	50	108,8	32	5	0,5	0,5	F3553C04.54.A04	●
	HSK-A100	50				50	115,3	50	5	0,5	0,5	F3553C06.54.A04	●		
	M10	10				HSK-A63	45	50	108,8	32	5	0,5	0,5	F3553C04.54.A05	●
	HSK-A100	50				50	115,3	50	5	0,5	0,5	F3553C06.54.A05	●		
	M14 - M16	11 - 12				HSK-A63	45	50	108,8	32	5	0,5	0,5	F3553C04.54.A06	●
	HSK-A100	50				50	115,3	50	5	0,5	0,5	F3553C06.54.A06	●		
	M18	14				HSK-A63	45	50	108,8	32	5	0,5	0,5	F3553C04.54.A07	●
	HSK-A100	50				50	115,3	50	5	0,5	0,5	F3553C06.54.A07	●		
	M20	16	HSK-A63	45	50	108,8	32	5	0,5	0,5	F3553C04.54.A08	●			
	HSK-A100	50	50	115,3	50	5	0,5	0,5	F3553C06.54.A08	●					

Zubehör Accessories

Spannzangen Typ ER (GB)
Collets type ER (GB) ▶▶ 786 - 787

Dichtscheiben Typ DS/ER
Sealing disks type DS/ER ▶▶ 789

Längeneinstellschrauben
Length adjustment screws ▶▶ 784

Spannschlüsselsatz
Set of clamping wrenches ▶▶ 793

Montagevorrichtung
Assembly device ▶▶ 793

Drehmomentschlüssel TORCO-FIX
Torque wrenches TORCO-FIX ▶▶ 795

Kühlschmierstoffrohre und Schlüssel
Coolant tubes and wrenches ▶▶ 782 - 783

- Product Finder
- Softsynchro
- Speedsynchro
- KSN
- MQL MMS
- SFM
- SWITCH-MASTER
- GR, GR-S
- HF
- EM
- Zubehör Accessories
- Tech. Info

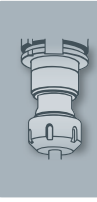

Softsynchro® Modular/MQL

≈ DIN 69893 C 2)

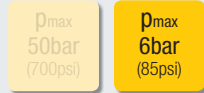
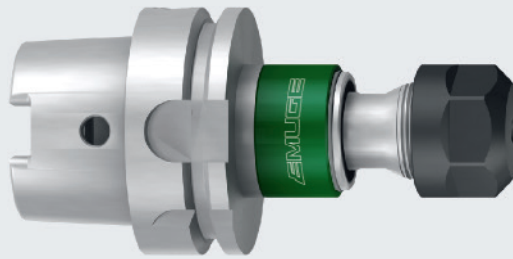

Mit Bohrung für Datenträger DIN 69873
With bore for data chip according to DIN 69873

Druck C T Zug
Compression Tension

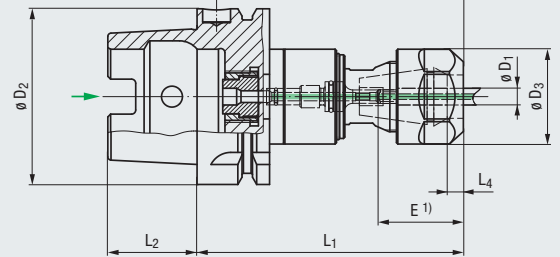

Einsatz auf Maschinen mit Synchronspindel For use on machines with synchronous spindle

new	Typ Type	ø D ₁	Werkzeugkegel Tool taper	ø D ₂	ø D	ø D ₃	L ₁	L ₂	L ₄	C	T	Artikel-Nr. Article no.				
Softsynchro® 1 Modular/MQL	M4,5 - M10	6 / 7	Innenkegel Internal taper 60°	ER 20 (GB)	Hi-Q/ERC 20	HSK-A40	34	34	89,5	20	5	0,5	0,5	F3551C02.52.I01	●	
						HSK-A63	34	34	95,5	32	5	0,5	0,5	F3551C04.52.I01	●	
						HSK-A100	34	34	102	50	5	0,5	0,5	F3551C06.52.I01	●	
	M8, M9, M11, M12	8 / 9	Innenkegel Internal taper 60°	ER 20 (GB)	Hi-Q/ERC 20	HSK-A40	34	34	89,5	20	5	0,5	0,5	F3551C02.52.I02	●	
						HSK-A63	34	34	95,5	32	5	0,5	0,5	F3551C04.52.I02	●	
						HSK-A100	34	34	102	50	5	0,5	0,5	F3551C06.52.I02	●	
	M10	10	Innenkegel Internal taper 60°	ER 20 (GB)	Hi-Q/ERC 20	HSK-A40	34	34	89,5	20	5	0,5	0,5	F3551C02.52.I03	●	
						HSK-A63	34	34	95,5	32	5	0,5	0,5	F3551C04.52.I03	●	
						HSK-A100	34	34	102	50	5	0,5	0,5	F3551C06.52.I03	●	
	M4,5 - M6 M8	6	Außenkegel External taper 90°	ER 20 (GB)	Hi-Q/ERC 20	HSK-A40	34	34	89,5	20	5	0,5	0,5	F3551C02.52.A04	●	
						HSK-A63	34	34	95,5	32	5	0,5	0,5	F3551C04.52.A04	●	
						HSK-A100	34	34	102	50	5	0,5	0,5	F3551C06.52.A04	●	
		M7, M10	7	Außenkegel External taper 90°	ER 20 (GB)	Hi-Q/ERC 20	HSK-A40	34	34	89,5	20	5	0,5	0,5	F3551C02.52.A05	●
							HSK-A63	34	34	95,5	32	5	0,5	0,5	F3551C04.52.A05	●
							HSK-A100	34	34	102	50	5	0,5	0,5	F3551C06.52.A05	●
		M8	8	Außenkegel External taper 90°	ER 20 (GB)	Hi-Q/ERC 20	HSK-A40	34	34	89,5	20	5	0,5	0,5	F3551C02.52.A06	●
							HSK-A63	34	34	95,5	32	5	0,5	0,5	F3551C04.52.A06	●
							HSK-A100	34	34	102	50	5	0,5	0,5	F3551C06.52.A06	●
M12	9	Außenkegel External taper 90°	ER 20 (GB)	Hi-Q/ERC 20	HSK-A40	34	34	89,5	20	5	0,5	0,5	F3551C02.52.A07	●		
					HSK-A63	34	34	95,5	32	5	0,5	0,5	F3551C04.52.A07	●		
					HSK-A100	34	34	102	50	5	0,5	0,5	F3551C06.52.A07	●		
M10	10	Außenkegel External taper 90°	ER 20 (GB)	Hi-Q/ERC 20	HSK-A40	34	34	89,5	20	5	0,5	0,5	F3551C02.52.A08	●		
					HSK-A63	34	34	95,5	32	5	0,5	0,5	F3551C04.52.A08	●		
					HSK-A100	34	34	102	50	5	0,5	0,5	F3551C06.52.A08	●		

1) Einstecktiefen E siehe Seite 797
Clamping depths E, see page 797

2) Außenkontur entspricht DIN 69893 A, Innenkontur nach DIN 69893 C
Outside contour acc. DIN 69893 A, inside contour acc. DIN 69893 C

Füllstück, Längeneinstellschraube sowie Spannmutter für Dichtscheiben sind im Lieferumfang enthalten
Adapter, length adjustment screw as well as clamping nut for sealing disks are included in the delivery

MMS-Übergabe passend zu DIN 69090-4 und vielen Werknormen
MQL supply according to DIN 69090-4 and many internal standards



Detaillierte Informationen zu
Softsynchro® Modular
siehe Seite 821 - 822

Detailed information
regarding Softsynchro® Modular
see page 821 - 822

Softsynchro® Modular/MQL

≈ DIN 69893 C 2)

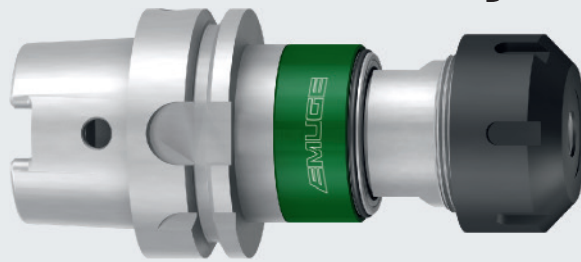

Mit Bohrung für Datenträger DIN 69873
With bore for data chip according to DIN 69873

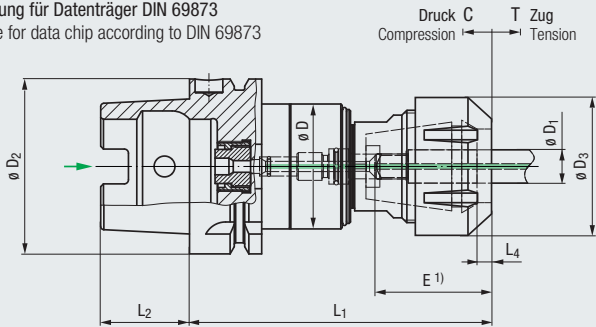

IKZ

MMS
MQL

MQL
1

p_{max}
50bar
(700psi)

p_{max}
6bar
(85psi)

C T
Soft

F

L+ 2 mm

[Icon: Collet]

[Icon: Cap]

Einsatz auf Maschinen
mit Synchronspindel

For use on machines
with synchronous spindle

new	Typ Type	$\varnothing D_1$	Werkzeugkegel Tool taper	$\varnothing D_2$	$\varnothing D$	$\varnothing D_3$	L_1	L_2	L_4	C	T	Artikel-Nr. Article no.			
Softsynchro® 3 Modular/MQL	M12	9	Innenkegel Internal taper 60° 	ER 32 (GB)	Hi-Q/ERC 32	HSK-A63	45	50	108,8	32	5	0,5	0,5	F3553C04.52.I01	●
	HSK-A100	50				50	115,3	50	5	0,5	0,5	F3553C06.52.I01	●		
	M10 - M16	10 - 12				HSK-A63	45	50	108,8	32	5	0,5	0,5	F3553C04.52.I02	●
	HSK-A100	50				50	115,3	50	5	0,5	0,5	F3553C06.52.I02	●		
	M18 - M20	14 - 16				HSK-A63	45	50	108,8	32	5	0,5	0,5	F3553C04.52.I03	●
	HSK-A100	50				50	115,3	50	5	0,5	0,5	F3553C06.52.I03	●		
	M12	9	Außenkegel External taper 90° 	ER 32 (GB)	Hi-Q/ERC 32	HSK-A63	45	50	108,8	32	5	0,5	0,5	F3553C04.52.A04	●
	HSK-A100	50				50	115,3	50	5	0,5	0,5	F3553C06.52.A04	●		
	M10	10				HSK-A63	45	50	108,8	32	5	0,5	0,5	F3553C04.52.A05	●
	HSK-A100	50				50	115,3	50	5	0,5	0,5	F3553C06.52.A05	●		
	M14 - M16	11 - 12				HSK-A63	45	50	108,8	32	5	0,5	0,5	F3553C04.52.A06	●
	HSK-A100	50				50	115,3	50	5	0,5	0,5	F3553C06.52.A06	●		
	M18	14	HSK-A63	45	50	108,8	32	5	0,5	0,5	F3553C04.52.A07	●			
	HSK-A100	50	50	115,3	50	5	0,5	0,5	F3553C06.52.A07	●					
	M20	16	HSK-A63	45	50	108,8	32	5	0,5	0,5	F3553C04.52.A08	●			
HSK-A100	50	50	115,3	50	5	0,5	0,5	F3553C06.52.A08	●						

Zubehör

Accessories

Spannzangen Typ ER (GB)
Collets type ER (GB) ▶▶ 786 - 787

Dichtscheiben Typ DS/ER
Sealing disks type DS/ER ▶▶ 789

Längeneinstellschrauben
Length adjustment screws ▶▶ 784

Spannschlüsselsatz
Set of clamping wrenches ▶▶ 793

Montagevorrichtung
Assembly device ▶▶ 793

Drehmomentschlüssel TORCO-FIX
Torque wrenches TORCO-FIX ▶▶ 795

Füllstück
Adapter ▶▶ 783

● = Lagerwerkzeug, siehe Preisliste · Stock tool, see price list
○ = Kurzfristig lieferbar, Preis auf Anfrage · Available on short notice, price upon inquiry

Product Finder

- Softsynchro
- Speedsynchro
- KSN
- MQL MMS
- SFM
- SWITCH-MASTER
- GR, GR-S
- HF
- EM
- Zubehör Accessories
- Tech. Info

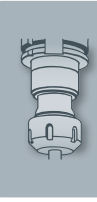

Speedsynchro® Modular/MQL

ABS®

(System KOMET)

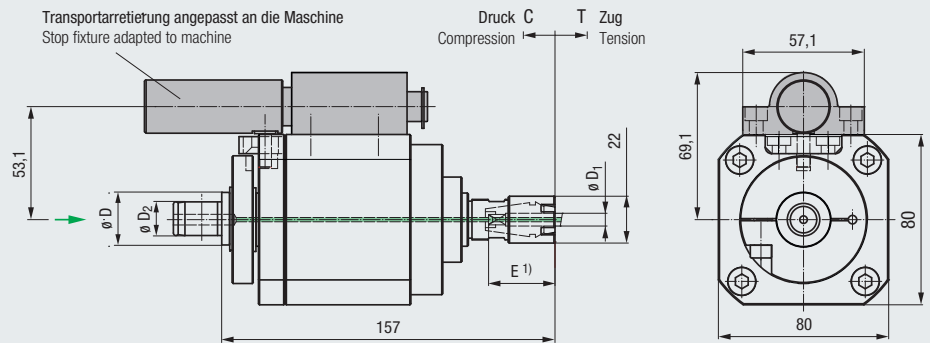

Einsatz auf Maschinen mit Synchronspindel For use on machines with synchronous spindle

new											
Typ Type				∅ D	∅ D ₂	∅ D ₁	Max. Spindeldrehzahl Max. spindle speed	Übersetzungsverhältnis Transmission ratio	C	T	Artikel-Nr. Article no.
Speedsynchro® Modular/MQL	M1 - M8	ER 16 (GB)	Hi-Q/ERMC 16	ABS 32	16	2,5 - 8	2000	1 : 4,412	0,5	0,5	F3751L01

1) Einstecktiefen E siehe Seite 797
Clamping depths E, see page 797

Adaptionsschäft, Transportarretierung (siehe auch Seite 827) und Längeneinstellschraube sind nicht im Lieferumfang enthalten, bitte extra bestellen
Adapter shank, stop fixture (see also page 827) and length adjustment screw are not included in the delivery, please order separately

Zubehör Accessories

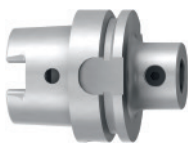

Adaptionsschäfte
Adapter shanks

» 781



Montagevorrichtung
Assembly device

» 793



Spannzangen Typ ER (GB)
Collets type ER (GB)

» 786 - 787

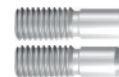

Längeneinstellschrauben
Length adjustment screws

» 785



Dichtscheiben Typ DS/ER
Sealing disks type DS/ER

» 789



Mehr Informationen zum
Speedsynchro® Modular unter

More information regarding
Speedsynchro® Modular at

www.speedsynchro.com

KSN/MQL
DIN 69893 A

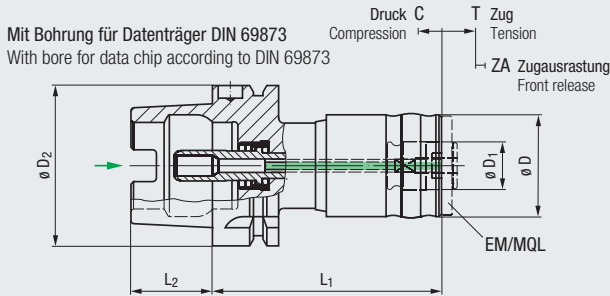
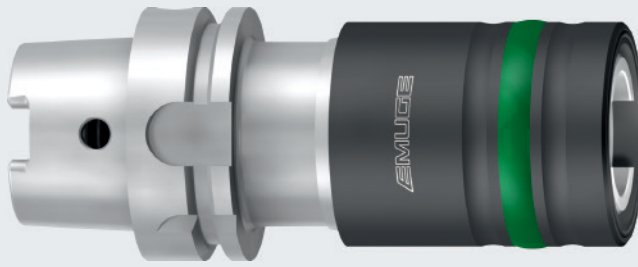

IKZ

MMS
MQL

MQL
1

p_{max}
50bar
(700psi)

p_{max}
6bar
(85psi)

C T

F

↔

Einsatz auf CNC-Bearbeitungszentren
und sonstigen Werkzeugmaschinen

For use on CNC machining centres
and other machine tools

Typ Type			$\varnothing D_2$	$\varnothing D$	$\varnothing D_1$	L ₁	L ₂	C	T	ZA	Artikel-Nr. Article no.	
KSN 1/MQL	M6 - M12 (Nr.10 - 1/2)	EM 01/MQL	HSK-A40	40	19	88	20	5	5	2,5	F3471C02.1	●
			HSK-A50	40	19	90	25	5	5	2,5	F3471C03.1	●
			HSK-A63	40	19	90	32	5	5	2,5	F3471C04.1	●
			HSK-A80	40	19	93	40	5	5	2,5	F3471C05.1	●
			HSK-A100	40	19	93	50	5	5	2,5	F3471C06.1	●
KSN 3/MQL	M10 - M24 (9/16 - 1")	EM 03/MQL	HSK-A63	56	31	120	32	7	7	3	F3473C04.1	●
			HSK-A80	56	31	125	40	7	7	3	F3473C05.1	●
			HSK-A100	56	31	128	50	7	7	3	F3473C06.1	●

Weitere Ausführungen auf Anfrage
Further designs upon request

Das Kühlschmierstoffrohr ist im Schaft enthalten und darf nicht demontiert werden, da sonst die Funktion der MMS-Übergabe nicht mehr gewährleistet ist!
The coolant tube is integrated into the shank and must not be disassembled, otherwise the function of the MQL transfer is no longer warranted!

MMS-Übergabe passend zu DIN 69090-4 und vielen Werknormen
MQL supply according to DIN 69090-4 and many internal standards

Zubehör
Accessories

Schnellwechsel-Einsätze Typ EM/MQL
Quick-change adapters type EM/MQL [» 730](#)

Schnellwechsel-Einsätze Typ EM-Z/MQL
Quick-change adapters type EM-Z/MQL [» 731 - 732](#)

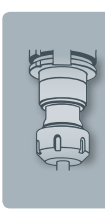

- Product Finder
- Soft-synchro
- Speed-synchro
- KSN
- ML MMS**
- SFM
- SWITCH-MASTER
- GR, GR-S
- HF
- EM
- Zubehör Accessories
- Tech. Info

KSN/MQL

DIN 69893 A

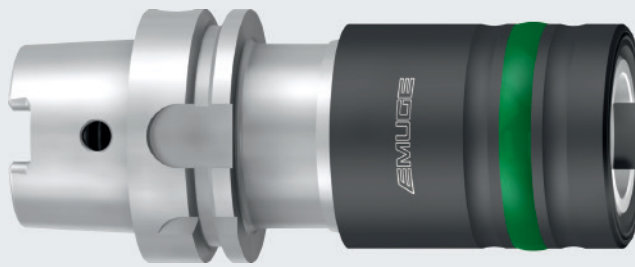

p_{max}
50bar
(700psi)

p_{max}
6bar
(85psi)

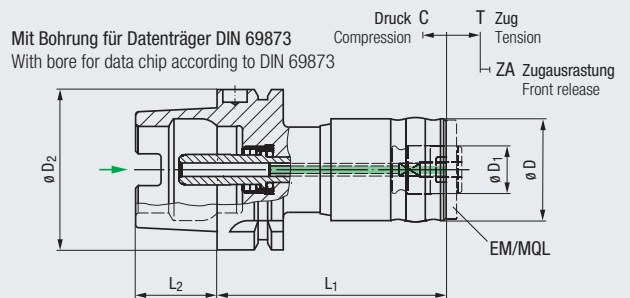

Einsatz auf CNC-Bearbeitungszentren und sonstigen Werkzeugmaschinen For use on CNC machining centres and other machine tools

Typ Type			$\varnothing D_2$	$\varnothing D$	$\varnothing D_1$	L_1	L_2	C	T	ZA	Artikel-Nr. Article no.
KSN 1/MQL	M6 - M12 (Nr.10 - 1/2)	EM 01/MQL	HSK-A40	40	19	88	20	5	5	2,5	F3481C02.1
			HSK-A50	40	19	90	25	5	5	2,5	F3481C03.1
			HSK-A63	40	19	90	32	5	5	2,5	F3481C04.1
			HSK-A80	40	19	93	40	5	5	2,5	F3481C05.1
			HSK-A100	40	19	93	50	5	5	2,5	F3481C06.1

Weitere Ausführungen auf Anfrage
Further designs upon request

Das Kühlschmierstoffrohr ist im Schaft enthalten und darf nicht demontiert werden, da sonst die Funktion der MMS-Übergabe nicht mehr gewährleistet ist!
The coolant tube is integrated into the shank and must not be disassembled, otherwise the function of the MQL transfer is no longer warranted!

MMS-Übergabe passend zu DIN 69090-4 und vielen Werknormen
MQL supply according to DIN 69090-4 and many internal standards

Zubehör Accessories

- Schnellwechsel-Einsätze Typ EM/MQL
Quick-change adapters type EM/MQL
» » 730
- Schnellwechsel-Einsätze Typ EM-Z/MQL
Quick-change adapters type EM-Z/MQL
» » 731

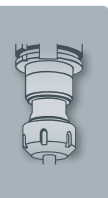

KSN/MQL
≈ DIN 69893 C 1)

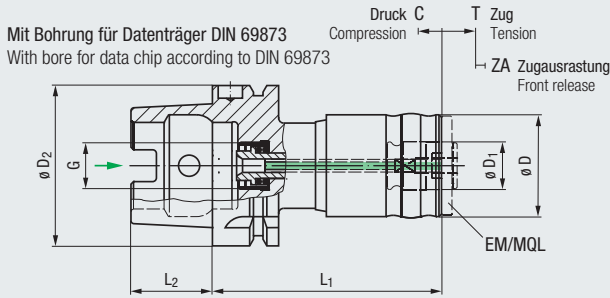
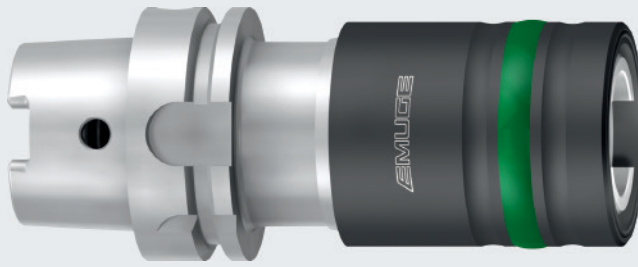

IKZ

MMS
MQL

MQL
1

p_{max}
50bar
(700psi)

p_{max}
6bar
(85psi)

C T

F

← →

**Einsatz auf CNC-Bearbeitungszentren
und sonstigen Werkzeugmaschinen**

For use on CNC machining centres
and other machine tools

Typ Type			$\varnothing D_2$	$\varnothing D$	$\varnothing D_1$	L_1	L_2	C	T	ZA	Artikel-Nr. Article no.	
KSN 1/MQL	M6 - M12 (Nr.10 - 1/2)	EM 01/MQL	HSK-A40	40	19	88	20	5	5	2,5	F3471C02.1.52	●
			HSK-A50	40	19	90	25	5	5	2,5	F3471C03.1.52	●
			HSK-A63	40	19	90	32	5	5	2,5	F3471C04.1.52	●
KSN 3/MQL	M10 - M24 (9/16 - 1")	EM 03/MQL	HSK-A63	56	31	120	32	7	7	3	F3473C04.1.52	●
			HSK-A80	56	31	125	40	7	7	3	F3473C05.1.52	●
			HSK-A100	56	31	128	50	7	7	3	F3473C06.1.52	●

1) Außenkontur entspricht DIN 69893 A, Innenkontur nach DIN 69893 C
Outside contour acc. DIN 69893 A, inside contour acc. DIN 69893 C

Weitere Ausführungen auf Anfrage
Further designs upon request

Das Kühlschmierstoffrohr ist im Schaft enthalten und darf nicht demontiert werden, da sonst die Funktion der MMS-Übergabe nicht mehr gewährleistet ist!
The coolant tube is integrated into the shank and must not be disassembled, otherwise the function of the MQL transfer is no longer warranted!

MMS-Übergabe passend zu DIN 69090-4 und vielen Werknormen
MQL supply according to DIN 69090-4 and many internal standards

Zubehör
Accessories

Schnellwechsel-Einsätze Typ EM/MQL
Quick-change adapters type EM/MQL ▶ ▶ 730

Schnellwechsel-Einsätze Typ EM-Z/MQL
Quick-change adapters type EM-Z/MQL ▶ ▶ 731 - 732

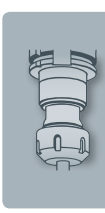

- Product Finder
- Soft-synchro
- Speed-synchro
- KSN
- ML MMS
- SFM
- SWITCH-MASTER
- GR, GR-S
- HF
- EM
- Zubehör Accessories
- Tech. Info

EM/MQL

DIN

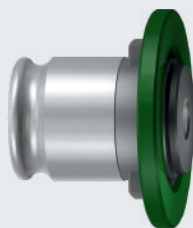

p_{max}
50bar
(700psi)

p_{max}
6bar
(85psi)

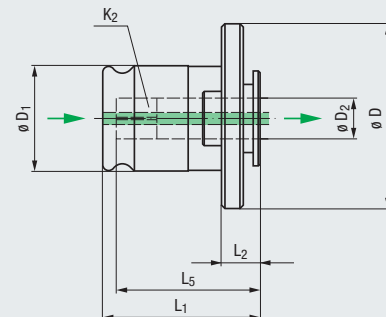

Typ · Type	EM 01/MQL	EM 03/MQL			
	M6 - M12	M10 - M24			
$\varnothing D$	39	55			
$\varnothing D_1$	19	31			
L_1	29	45			
L_2	7,5	10			

DIN				Artikel-Nr. Article no.	L_5	Artikel-Nr. Article no.	L_5											
$\varnothing D_2$	K_2																	
6	4,9	M6	M8	F4491106.6	25 ●													
7	5,5	M7	M9 - M10	F4491107.6	25 ●													
8	6,2	M8	M11	F4491108.6	26 ●													
9	7	M9	M12	F4491109.6	27 ●													
10	8	M10		F4491110.6	27 ●	F4493110.6	40 ●											
11	9		M14			F4493111.6	41 ●											
12	9		M16			F4493112.6	41 ●											
14	11		M18			F4493113.6	43 ●											
16	12		M20			F4493114.6	44 ●											
18	14,5		M22 - M24			F4493115.6	44 ●											

1) Bei Verwendung von Gewindebohrern / Gewindefornern mit innerer Kühlschmierstoff-Zufuhr
If used with taps / cold-forming taps with internal coolant supply

Nur für Schnellwechsel-Aufnahmen der Typenreihe KSN/MQL geeignet
Only suitable for quick-change tap holders type KSN/MQL

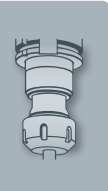

EM-Z/MQL

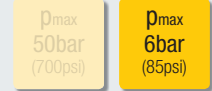
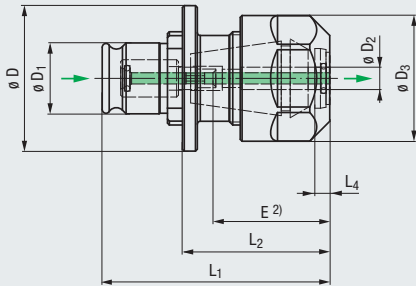
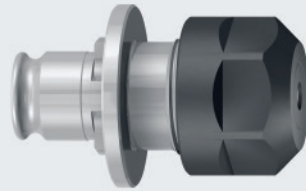

Product Finder

Soft-synchro

Speed-synchro

KSN

MQL MMS

SFM

SWITCH-MASTER

GR, GR-S

HF

EM

Zubehör Accessories

Tech. Info

new	Typ Type	ø D ₂	Werkzeugkegel Tool taper			ø D	ø D ₁	ø D ₃	L ₁	L ₂	Artikel-Nr. Article no.	
EM 01-Z/MQL	M4,5 - M10	6 / 7	Innenkegel Internal taper 60° 	ER 20 (GB)	Hi-Q/ERC 20	39	19	34	61	39,5	F4501001.13D6	○
	M8, M9, M11, M12	8 / 9				39	19	34	61	39,5	F4501001.13D8	○
	M10	10				39	19	34	61	39,5	F4501001.13D10	○
	M4,5 - M6 M8	6	Außenkegel External taper 90° 	ER 20 (GB)	Hi-Q/ERC 20	55	31	34	81,5	46,5	F4501001.23D6	○
	M7, M10	7				55	31	34	81,5	46,5	F4501001.23D7	○
	M8	8				55	31	34	81,5	46,5	F4501001.23D8	○
	M12	9				55	31	34	81,5	46,5	F4501001.23D9	○
	M10	10				55	31	34	81,5	46,5	F4501001.23D10	○

1) Bei Verwendung von Gewindebohrern / Gewindeformern mit innerer Kühlschmierstoff-Zufuhr
If used with taps / cold-forming taps with internal coolant supply

2) Einstecktiefen E siehe Seite 797
Clamping depths E, see page 797

Nur für Schnellwechsel-Aufnahmen der Typenreihe KSN/MQL geeignet
Only suitable for quick-change tap holders type KSN/MQL

Längeneinstellschraube sowie Spannmutter für Dichtscheiben sind im Lieferumfang enthalten
Length adjustment screw as well as clamping nut for sealing disks are included in the delivery

Zubehör
Accessories



Spannzangen Typ ER (GB)
Collets type ER (GB)

» 786 - 787



Dichtscheiben Typ DS/ER
Sealing disks type DS/ER

» 789



Spannschlüssel
Clamping wrench

» 794



- Product Finder
- Soft-synchro
- Speed-synchro
- KSN
- MQL MMS
- SFM
- SWITCH-MASTER
- GR, GR-S
- HF
- EM
- Zubehör Accessories
- Tech. Info

EM-Z/MQL

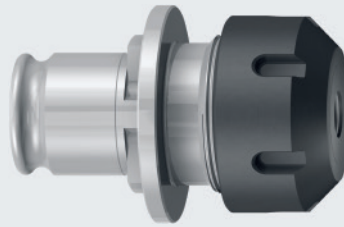

p_{max}
50bar
(700psi)

p_{max}
6bar
(85psi)

L+ 2 mm

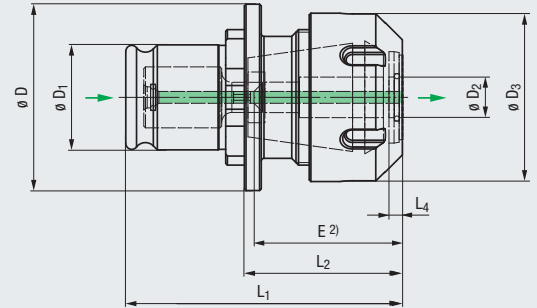

new	Typ Type	$\varnothing D_2$	Werkzeugkegel Tool taper			$\varnothing D$	$\varnothing D_1$	$\varnothing D_3$	L_1	L_2	Artikel-Nr. Article no.	
EM 03-Z/MQL	M10 - M16	10 - 12	Innenkegel Internal taper 60° 	ER 32 (GB)	Hi-Q/ERC 32	55	31	50	81,5	46,5	F4503001.13D10	○
	M18 - M20	14 - 16				55	31	50	81,5	46,5	F4503001.13D14	○
	M10	10	Außenkegel External taper 90° 	ER 32 (GB)	Hi-Q/ERC 32	55	31	50	81,5	46,5	F4503001.23D10	○
	M14 - M16	11 - 12				55	31	50	81,5	46,5	F4503001.23D12	○
	M18	14				55	31	50	81,5	46,5	F4503001.23D14	○
	M20	16				55	31	50	81,5	46,5	F4503001.23D16	○

1) Bei Verwendung von Gewindebohrern / Gewindeformern mit innerer Kühlschmierstoff-Zufuhr
If used with taps / cold-forming taps with internal coolant supply

2) Einstecktiefen E siehe Seite 797
Clamping depths E, see page 797

Nur für Schnellwechsel-Aufnahmen der Typenreihe KSN/MQL geeignet
Only suitable for quick-change tap holders type KSN/MQL

Längeneinstellschraube sowie Spannmutter für Dichtscheiben sind im Lieferumfang enthalten
Length adjustment screw as well as clamping nut for sealing disks are included in the delivery

Zubehör Accessories



Spannzangen Typ ER (GB)
Collets type ER (GB)

» 786 - 787



Dichtscheiben Typ DS/ER
Sealing disks type DS/ER

» 789



Spannschlüssel
Clamping wrench

» 794

Product
FinderSoft-
synchroSpeed-
synchro

KSN

MQL
MMS

SFM

SWITCH-
MASTER

GR, GR-S

HF

EM

Zubehör
Accessories

Tech. Info

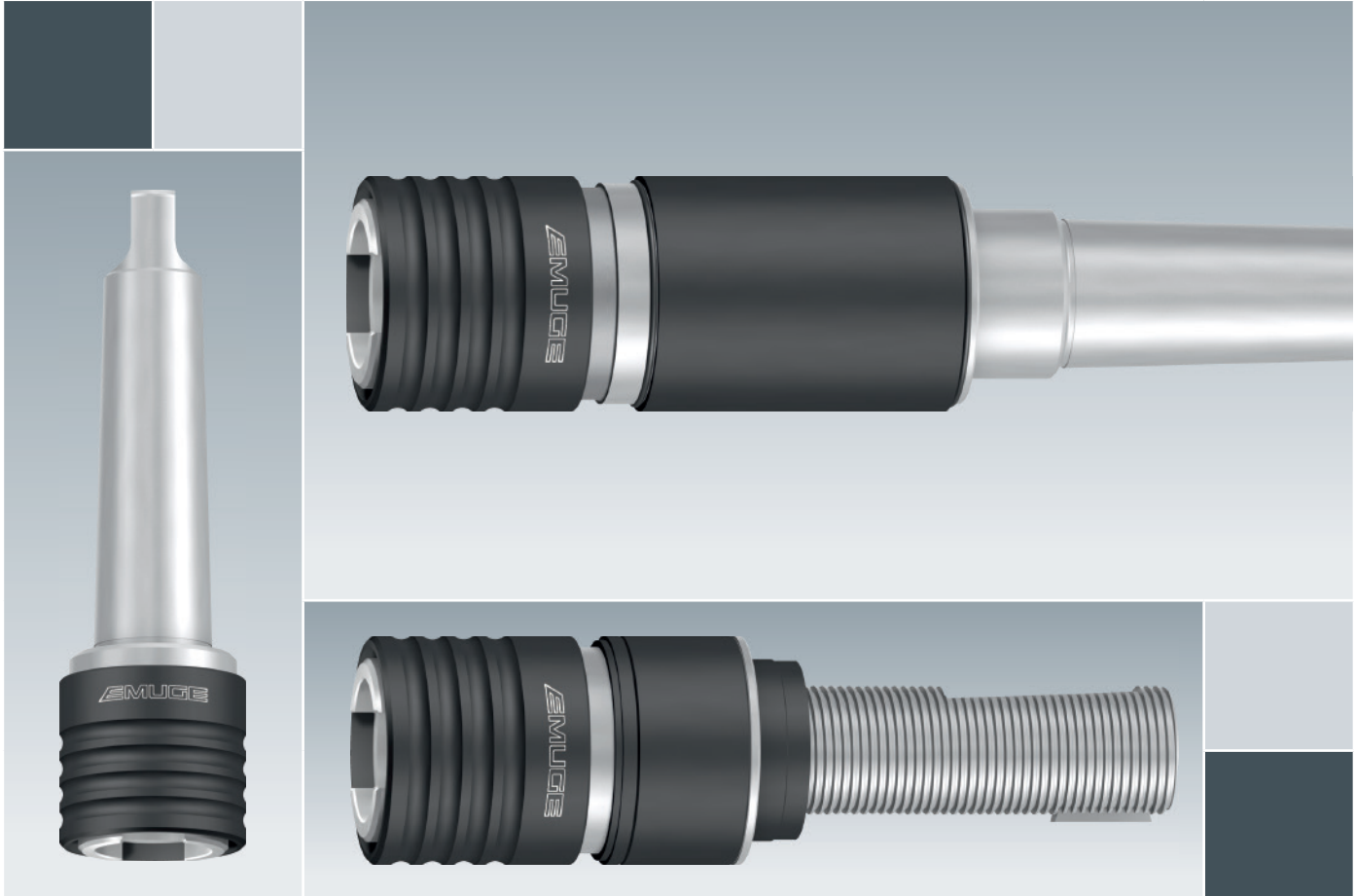

Typenreihe SFM

SFM Series

Einsatz auf Mehrspindelmaschinen und Transferstraßen

Auf Grund ihrer schlanken Bauform besonders geeignet auch für Mehrspindelköpfe.

Application on multi-spindle machines and transfer lines

Especially suitable, too, for multi-spindle heads due to their slim design.



- Product Finder
- Soft-synchro
- Speed-synchro
- KSN
- MQL MMS
- SFM**
- SWITCH-MASTER
- GR, GR-S
- HF
- EM
- Zubehör Accessories
- Tech. Info

SFM DIN 228 B

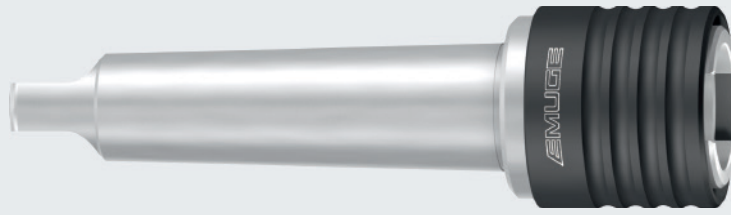

p_{max}
50bar
(700psi)

p_{max}
6bar
(85psi)

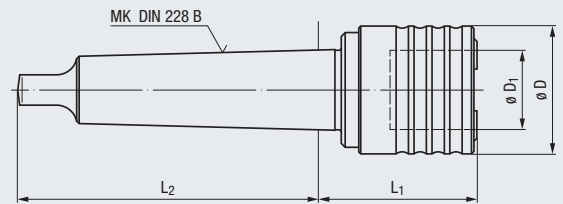

Einsatz auf Mehrspindelmaschinen und Transferstraßen For use on multi-spindle machines and transfer lines

Typ Type			MK	ø D	ø D ₁	L ₁	L ₂	Artikel-Nr. Article no.	
SFM 00	M1 - M10 (Nr.0 - 3/8)	EM 00	MK 1	23	13	39	62	F0100101	●
			MK 2	23	13	40	75	F0100102	●
SFM 01	M3 - M14 (Nr.4 - 9/16)	EM 01	MK 1	32	19	43	62	F0101101	●
			MK 2	32	19	44	75	F0101102	●
			MK 3	32	19	44	94	F0101103	●
SFM 03	M4,5 - M24 (Nr.10 - 1")	EM 03	MK 2	50	31	61	75	F0103102	●
			MK 3	50	31	61	94	F0103103	●
			MK 4	50	31	62	117,5	F0103104	●
SFM 04	M14 - M36 (9/16 - 1 3/8)	EM 04	MK 3	72	48	90	94	F0104103	●
			MK 4	72	48	91	117,5	F0104104	●
			MK 5	72	48	95	149,5	F0104105	●

Morsekegelschaft mit Anzugsgewinde nach DIN 228 A auf Anfrage
Morse taper shank with clamping thread acc. DIN 228 A upon request

Weitere Ausführungen auf Anfrage
Further designs upon request

Zubehör Accessories



Schnellwechsel-Einsätze Typenreihe EM
Quick-change adapters EM series » 755 - 778

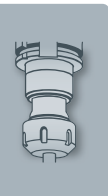

SFM
DIN 6327

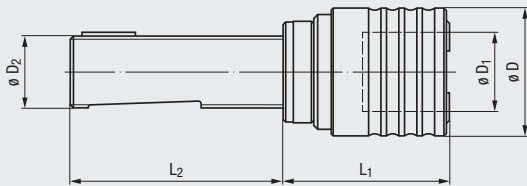
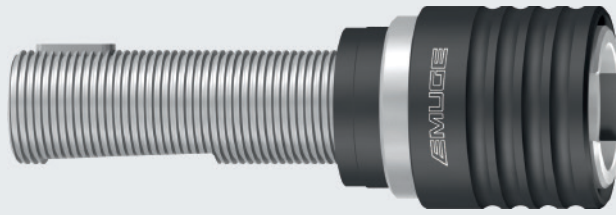

IKZ

MMS
MQL

p_{max}
50bar
(700psi)

p_{max}
6bar
(85psi)

C T

F

↻

🔧

🌀

🔧

Einsatz auf Mehrspindelmaschinen
und Transferstraßen

For use on multi-spindle machines
and transfer lines

Typ Type			$\varnothing D_2$	$\varnothing D$	$\varnothing D_1$	L_1	L_2	Artikel-Nr. Article no.	
SFM 00	M1 - M10 (Nr.0 - 3/8)	EM 00	Tr 16 x 1,5	23	13	45	73	F0100213	●
			Tr 20 x 2	23	13	45	76	F0100214	○
SFM 01	M3 - M14 (Nr.4 - 9/16)	EM 01	Tr 16 x 1,5	32	19	49	73	F0101213	●
			Tr 20 x 2	32	19	49	76	F0101214	●
			Tr 28 x 2	32	19	49	83	F0101216	●
SFM 03	M4,5 - M24 (Nr.10 - 1")	EM 03	Tr 20 x 2	50	31	66	76	F0103214	●
			Tr 28 x 2	50	31	66	83	F0103216	●
			Tr 36 x 2	50	31	68	104	F0103218	●
SFM 04	M14 - M36 (9/16 - 1 3/8)	EM 04	Tr 28 x 2	72	48	95	83	F0104216	○
			Tr 36 x 2	72	48	97	104	F0104218	●
			Tr 48 x 2	72	48	101	126	F0104219	○

Weitere Ausführungen auf Anfrage
Further designs upon request

Zubehör
Accessories



Schnellwechsel-Einsätze Typenreihe EM
Quick-change adapters EM series ▶ 755 - 778

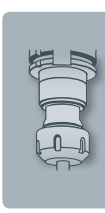

- Product Finder
- Soft-synchro
- Speed-synchro
- KSN
- MQL MMS
- SFM
- SWITCH-MASTER
- GR, GR-S
- HF
- EM
- Zubehör Accessories
- Tech. Info

SFM-NP

DIN 6327

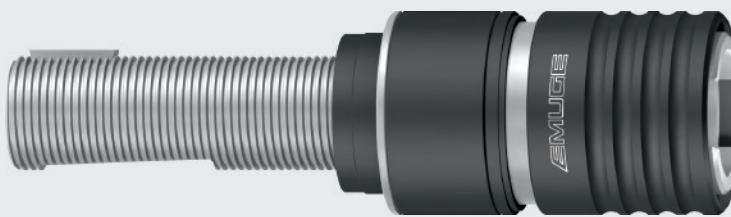

IKZ

MMS
MQL

p_{max}
50bar
(700psi)

p_{max}
6bar
(85psi)

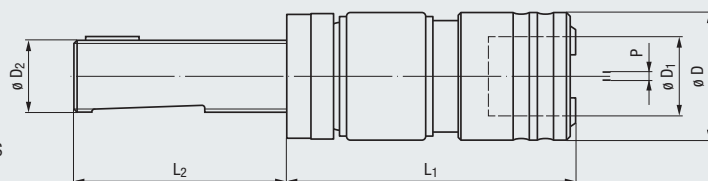

Einsatz auf Mehrspindelmaschinen und Transferstraßen For use on multi-spindle machines and transfer lines

Typ Type			$\varnothing D_2$	$\varnothing D$	$\varnothing D_1$	L_1	L_2	P	Artikel-Nr. Article no.	
SFM 00-NP	M1 - M10 (Nr.0 - 3/8)	EM 00	Tr 16 x 1,5	23	13	65	73	0,8	F2110213	o
			Tr 20 x 2	23	13	65	76	0,8	F2110214	o
SFM 01-NP	M3 - M14 (Nr.4 - 9/16)	EM 01	Tr 16 x 1,5	32	19	70	73	1,4	F2111213	o
			Tr 20 x 2	32	19	70	76	1,4	F2111214	o
			Tr 28 x 2	32	19	70	83	1,4	F2111216	o
SFM 03-NP	M4,5 - M24 (Nr.10 - 1")	EM 03	Tr 20 x 2	50	31	96	76	2,5	F2113214	o
			Tr 28 x 2	50	31	96	83	2,5	F2113216	o
			Tr 36 x 2	50	31	98	104	2,5	F2113218	o

Weitere Ausführungen auf Anfrage
Further designs upon request

Zubehör Accessories



Schnellwechsel-Einsätze Typenreihe EM
Quick-change adapters EM series [» 755 - 778](#)

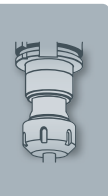

Informationen zur neuen **EG-Maschinenrichtlinie 2006/42/EG**,
siehe Seite 656

Information regarding the new **EC Machinery Directive 2006/42/EC**,
see page 656

SFM-L-DZ

DIN 228 B

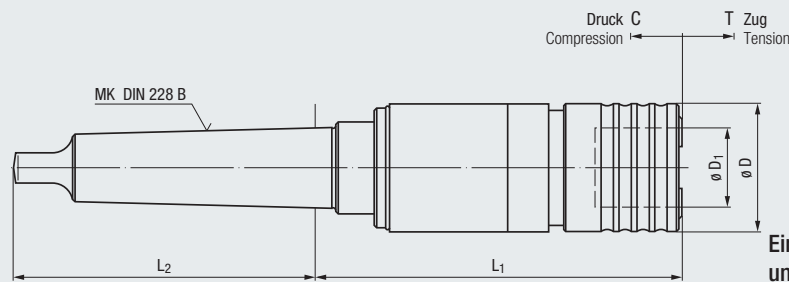
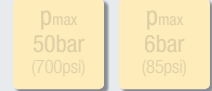
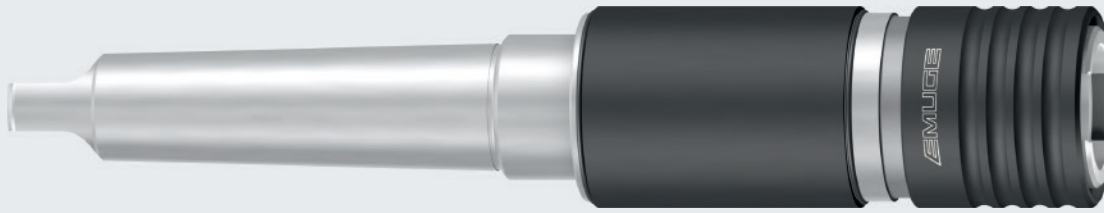

Einsatz auf Mehrspindelmaschinen und Transferstraßen

For use on multi-spindle machines and transfer lines

Typ Type			MK	ø D	ø D ₁	L ₁	L ₂	C	T	Artikel-Nr. Article no.			
SFM 00-L20-DZ	M1 - M10 (Nr.0 - 3/8)	EM 00	MK 1	23	13	90	62	10	10	F0180101.7	●		
			MK 2	23	13	91	75	10	10	F0180102.7	●		
MK 1			23	13	105	62	15	15	F0190101.7	●			
MK 2			23	13	106	75	15	15	F0190102.7	●			
SFM 01-L20-DZ	M3 - M14 (Nr.4 - 9/16)	EM 01	MK 1	32	19	102	62	10	10	F0181101.7	○		
			MK 2	32	19	103	75	10	10	F0181102.7	●		
			MK 3	32	19	103	94	10	10	F0181103.7	●		
SFM 01-L30-DZ			MK 1	32	19	117	62	15	15	F0191101.7	○		
			MK 2	32	19	118	75	15	15	F0191102.7	●		
			MK 3	32	19	118	94	15	15	F0191103.7	●		
SFM 01-L40-DZ			MK 1	32	19	132	62	20	20	F0201101.7	○		
			MK 2	32	19	133	75	20	20	F0201102.7	●		
			MK 3	32	19	133	94	20	20	F0201103.7	●		
SFM 03-L30-DZ			M4,5 - M24 (Nr.10 - 1")	EM 03	MK 2	50	31	142	75	15	15	F0183102.7	○
					MK 3	50	31	142	94	15	15	F0183103.7	●
MK 4					50	31	143	117,5	15	15	F0183104.7	●	
SFM 03-L40-DZ	MK 2	50			31	157	75	20	20	F0193102.7	○		
	MK 3	50			31	157	94	20	20	F0193103.7	●		
	MK 4	50			31	158	117,5	20	20	F0193104.7	●		
SFM 04-L30-DZ	M14 - M36 (9/16 - 1 3/8)	EM 04			MK 3	72	48	188	94	15	15	F0184103.7	○
					MK 4	72	48	189	117,5	15	15	F0184104.7	●
MK 5			72	48	190	149,5	15	15	F0184105.7	●			
SFM 04-L40-DZ			MK 3	72	48	203	94	20	20	F0194103.7	○		
			MK 4	72	48	204	117,5	20	20	F0194104.7	●		
			MK 5	72	48	205	149,5	20	20	F0194105.7	●		

Morsekegelschaft mit Anzugsgewinde nach DIN 228 A auf Anfrage
Morse taper shank with clamping thread acc. DIN 228 A upon request

Weitere Ausführungen auf Anfrage
Further designs upon request

Zubehör

Accessories



Schnellwechsel-Einsätze Typenreihe EM
Quick-change adapters EM series ▶ 755 - 778



SFM-L-DZ

DIN 6327

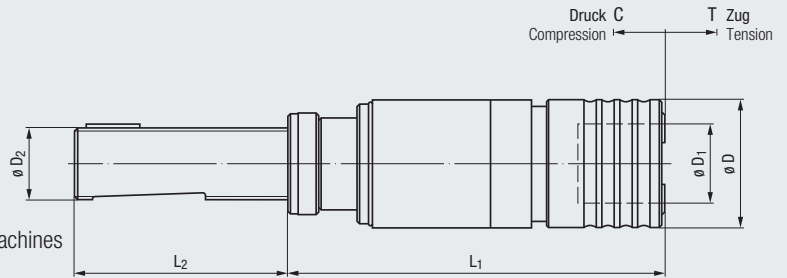
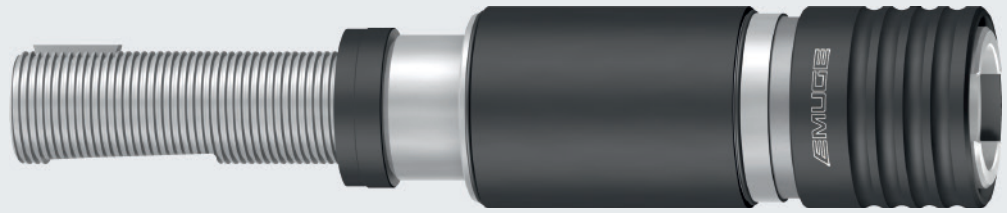

Einsatz auf Mehrspindelmaschinen und Transferstraßen | For use on multi-spindle machines and transfer lines

Typ Type			ø D ₂	ø D	ø D ₁	L ₁	L ₂	C	T	Artikel-Nr. Article no.			
SFM 00-L20-DZ	M1 - M10 (Nr.0 - 3/8)	EM 00	Tr 16 x 1,5	23	13	96	73	10	10	F0180213.7	●		
			Tr 20 x 2	23	13	96	76	10	10	F0180214.7	●		
Tr 16 x 1,5			23	13	111	73	15	15	F0190213.7	●			
Tr 20 x 2			23	13	111	76	15	15	F0190214.7	●			
SFM 01-L20-DZ	M3 - M14 (Nr.4 - 9/16)	EM 01	Tr 16 x 1,5	32	19	108	73	10	10	F0181213.7	●		
			Tr 20 x 2	32	19	108	76	10	10	F0181214.7	●		
			Tr 28 x 2	32	19	108	83	10	10	F0181216.7	●		
SFM 01-L30-DZ			Tr 16 x 1,5	32	19	123	73	15	15	F0191213.7	●		
			Tr 20 x 2	32	19	123	76	15	15	F0191214.7	●		
			Tr 28 x 2	32	19	123	83	15	15	F0191216.7	○		
SFM 01-L40-DZ			Tr 16 x 1,5	32	19	138	73	20	20	F0201213.7	●		
			Tr 20 x 2	32	19	138	76	20	20	F0201214.7	●		
			Tr 28 x 2	32	19	138	83	20	20	F0201216.7	●		
SFM 03-L30-DZ			M4,5 - M24 (Nr.10 - 1")	EM 03	Tr 20 x 2	50	31	147	76	15	15	F0183214.7	●
					Tr 28 x 2	50	31	147	83	15	15	F0183216.7	●
Tr 36 x 2					50	31	149	104	15	15	F0183218.7	●	
SFM 03-L40-DZ	Tr 20 x 2	50			31	162	76	20	20	F0193214.7	●		
	Tr 28 x 2	50			31	162	83	20	20	F0193216.7	●		
	Tr 36 x 2	50			31	164	104	20	20	F0193218.7	○		
SFM 04-L30-DZ	M14 - M36 (9/16 - 1 3/8)	EM 04			Tr 28 x 2	72	48	193	83	15	15	F0184216.7	○
					Tr 36 x 2	72	48	195	104	15	15	F0184218.7	●
Tr 48 x 2			72	48	199	126	15	15	F0184219.7	○			
SFM 04-L40-DZ			Tr 28 x 2	72	48	208	83	20	20	F0194216.7	○		
			Tr 36 x 2	72	48	210	104	20	20	F0194218.7	●		
			Tr 48 x 2	72	48	214	126	20	20	F0194219.7	○		

Weitere Ausführungen auf Anfrage
Further designs upon request

Zubehör Accessories



Schnellwechsel-Einsätze Typenreihe EM
Quick-change adapters EM series ▶▶ 755 - 778

Product
FinderSoft-
synchroSpeed-
synchro

KSN

MQL
MMS

SFM

SWITCH-
MASTER

GR, GR-S

HF

EM

Zubehör
Accessories

Tech. Info



Typenreihe SWITCH-MASTER® SWITCH-MASTER® Series

Einsatz auf CNC-Bearbeitungszentren und Sondermaschinen mit und ohne Synchronspindel

Durch das integrierte Wendegetriebe entfällt der Drehrichtungswechsel der Maschinenspindel beim Rücklauf. Speziell beim Typ SWITCH-MASTER® ergibt sich eine erhebliche Zeiteinsparung durch den patentierten Schaltmechanismus mittels Druckluft.

Application on CNC machining centres and special machines with and without synchronous spindle

No change of rotating direction of machine spindle at reverse stroke required due to integrated reverse gear. Especially for the SWITCH-MASTER® considerable saving of time due to patent-protected switch mechanism by compressed air.



SWITCH-MASTER®



- Product Finder
- Soft-synchro
- Speed-synchro
- KSN
- MQL MMS
- SFM
- SWITCH-MASTER**
- GR, GR-S
- HF
- EM
- Zubehör Accessories
- Tech. Info

IKZ

MMS MQL

ρ_{max}
50bar
(700psi)

ρ_{max}
6bar
(85psi)

T

Rubber Flex

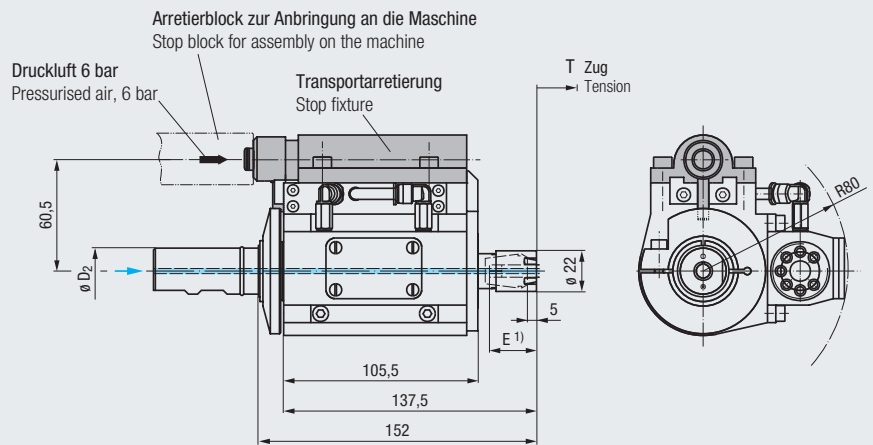

Einsatz auf Maschinen mit Synchronspindel, CNC-Bearbeitungszentren und sonstigen Werkzeugmaschinen

For use on machines with synchronous spindle, CNC machining centres and other machine tools

Typ Type				$\varnothing D_2$ DIN 1835 B	Drehzahl Speed/rpm	T	Gewicht Weight (kg)	Artikel-Nr. Article no.
SWITCH-MASTER 16 MV 90°	M4 - M12 (Nr.8 - 3/8)	ER 16 (GB)	Hi-Q/ERMC 16	25	max. 3000	9	3,7	F3381392

1) Einstecktiefen E siehe Seite 797
Clamping depths E, see page 797

Der Gewindeschneidapparat benötigt zum Reversieren Hilfsenergie in Form von Druckluft ($6^{+1}_{-0,5}$ bar)
The tapping attachment requires auxiliary energy = pressurised air ($6^{+1}_{-0,5}$ bar) for reversing

Adaptionsschäft, Arretierblock und Transportarretierung sind nicht im Lieferumfang enthalten, bitte extra bestellen
Adapter shank, stop block and stop fixture are not included in the delivery, please order separately

Die Übergabe der Druckluft erfolgt über einen speziellen Arretierblock, der maschinenseitig angebracht sein muss und in den gleichzeitig die Transportarretierung einrastet
The transfer of pressurised air is effected by means of a special stop block mounted on the machine, and into which the stop fixture engages

Zubehör Accessories

- Adaptionsschäfte
Adapter shanks » 780
- Spannzangen Typ ER (GB)
Collets type ER (GB) » 786 - 787
- Dichtscheiben Typ DS/ER
Sealing disks type DS/ER » 789

SWITCH-MASTER®

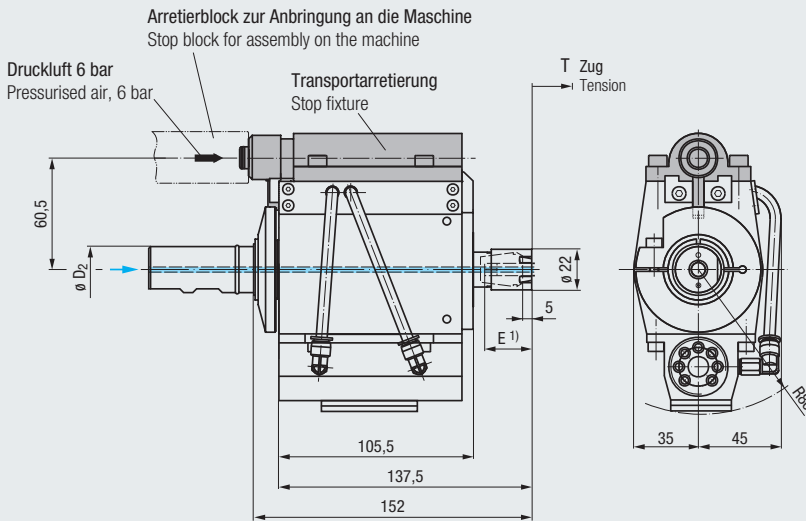
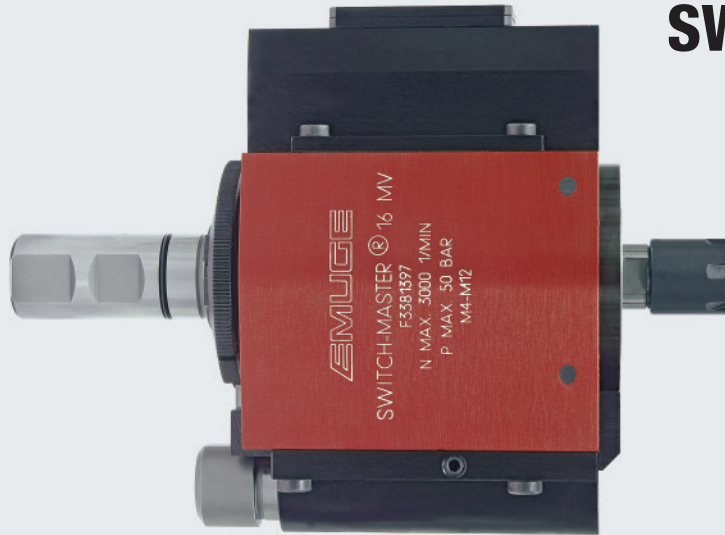

Einsatz auf Maschinen mit Synchronspindel, CNC-Bearbeitungszentren und sonstigen Werkzeugmaschinen

For use on machines with synchronous spindle, CNC machining centres and other machine tools

Typ Type				Ø D ₂ DIN 1835 B	Drehzahl Speed/rpm	T	Gewicht Weight	Artikel-Nr. Article no.
SWITCH-MASTER 16 MV 180°	M4 - M12 (Nr.8 - 3/8)	ER 16 (GB)	Hi-Q/ERMC 16	25	max. 3000	9	(kg) 3,7	F3381397

1) Einstecktiefen E siehe Seite 797
Clamping depths E, see page 797

Der Gewindeschneidapparat benötigt zum Reversieren Hilfsenergie in Form von Druckluft (6⁺¹_{-0,5} bar)
The tapping attachment requires auxiliary energy = pressurised air (6⁺¹_{-0,5} bar) for reversing

Adaptionsschäfte, Arretierblock und Transportarretierung sind nicht im Lieferumfang enthalten, bitte extra bestellen
Adapter shank, stop block and stop fixture are not included in the delivery, please order separately

Die Übergabe der Druckluft erfolgt über einen speziellen Arretierblock, der maschinenseitig angebracht sein muss und in den gleichzeitig die Transportarretierung einrastet
The transfer of pressurised air is effected by means of a special stop block mounted on the machine, and into which the stop fixture engages

Zubehör
Accessories

Adaptionsschäfte
Adapter shanks
» 780

Spannzangen Typ ER (GB)
Collets type ER (GB)
» 786 - 787

Dichtscheiben Typ DS/ER
Sealing disks type DS/ER
» 789

- Product Finder
- Soft-synchro
- Speed-synchro
- KSN
- ML MMS
- SFM
- SWITCH-MASTER**
- GR, GR-S
- HF
- EM
- Zubehör
Accessories
- Tech. Info

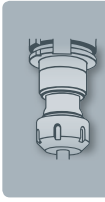

- Product Finder
- Soft-synchro
- Speed-synchro
- KSN
- MQL MMS
- SFM
- SWITCH-MASTER**
- GR, GR-S
- HF
- EM
- Zubehör Accessories
- Tech. Info



EMUGE
SWITCH-MASTER® 16 MV
13381397
N MAX. 3000 1/MIN
P MAX. 50 BAR
M-M12

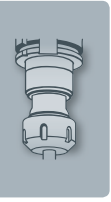



Typenreihe GR und GR-S GR and GR-S Series

Einsatz auf Säulenbohrmaschinen mit manuellem Vorschub

Durch das integrierte Wendegetriebe entfällt der Drehrichtungswechsel der Maschinenspindel beim Rücklauf. Zeitersparnis bei der Bearbeitung durch das Übersetzungsverhältnis Vor- zu Rücklauf, je nach Größe 1:1,6 bis 1:1,75.

Application on pillar drilling machines with manual feed

No change of rotating direction of machine spindle at reverse stroke required due to integrated reverse gear. Saving of time during machining due to the gear transmission ratio advanced/backwards movement, depending on size, 1:1.6 up to 1:1.75.



- Product Finder
- Soft-synchro
- Speed-synchro
- KSN
- MQL MMS
- SFM
- SWITCH-MASTER
- GR GR-S**
- HF
- EM
- Zubehör Accessories
- Tech. Info

GR



IKZ

MMS
MQL

p_{max}
50bar
(700psi)

p_{max}
6bar
(85psi)

C

T

C

T

Rubber
Flex

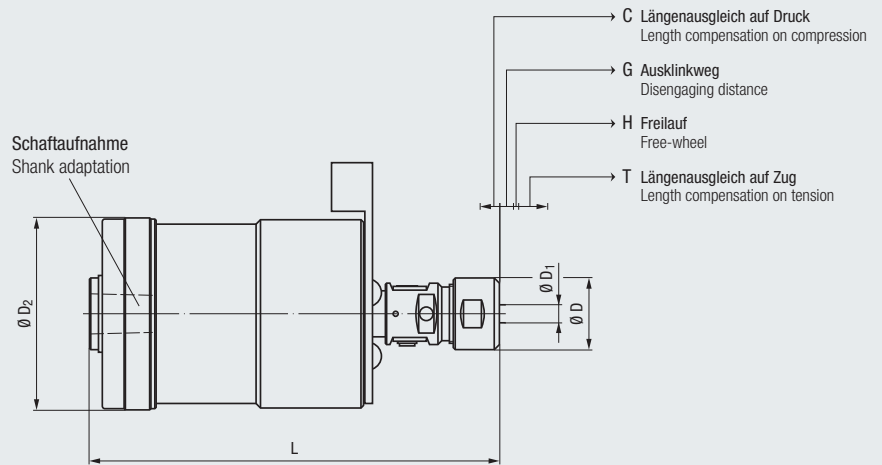

Einsatz auf Säulenbohrmaschinen For use on pillar drilling machines

Typ Type		ø D ₁	Schaftaufnahme Shank adaptation	Drehzahl Speed/rpm								Gewicht Weight (kg)	Artikel-Nr. Article no.	
				max.	ø D	ø D ₂	L	C	G	H	T			
GR 1	M2 - M7 (Nr.2 - 1/4)	2,5 - 6,5	B 16 DIN ISO 239	1500	23	55	130	5	3,5	1,5	7	1,0	F0401999	●
GR 2	M4 - M12 (Nr.8 - 7/16)	3,5 - 10	B 16 DIN ISO 239	1000	28	75	156	5	4	1,5	8,5	2,3	F0402999	●
GR 3	M8 - M20 (5/16 - 3/4)	6 - 16	M20	600	40	91	204	6	6	1,5	11,5	4,9	F0403999	●

Im Lieferumfang enthaltene Rubber-Flex-Spannzangen siehe Seite 746
 Rubber-Flex collets included in the delivery, see page 746

Zubehör Accessories



Schäfte
Shanks

» 746



Rubber-Flex-Spannzangen
Rubber-Flex collets

» 746

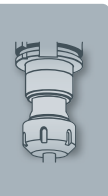

GR-S

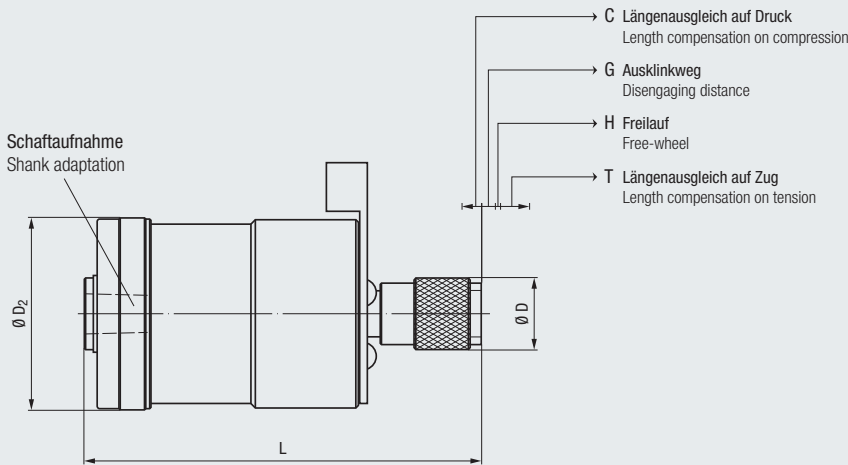

Product Finder

- Soft-synchro
- Speed-synchro
- KSN
- MQL MMS
- SFM
- SWITCH-MASTER
- GR, GR-S**
- HF
- EM
- Zubehör Accessories
- Tech. Info

IKZ MMS MQL

p_{max} 50bar (700psi) p_{max} 6bar (85psi)

C T

Rubber Flex

Einsatz auf Säulenbohrmaschinen For use on pillar drilling machines

Typ Type	Image	Schnellwechsel-Einsätze Typenreihe EM	Schaftaufnahme Shank adaptation	Drehzahl Speed/rpm								Gewicht Weight (kg)	Artikel-Nr. Article no.	●
				max.	$\varnothing D$	$\varnothing D_2$	L	C	G	H	T			
GR 1-S	M2 - M7 (Nr.2 - 1/4)	EM 00	B 16 DIN ISO 239	1500	25	55	139	5	3,5	1,5	7	1,2	F0411999	●
GR 2-S	M4 - M12 (Nr.8 - 7/16)	EM 01	B 16 DIN ISO 239	1000	32	75	157	5	4	1,5	8,5	2,3	F0412999	●
GR 3-S	M8 - M20 (5/16 - 3/4)	EM 03	M20	600	50	91	204	6	6	1,5	11,5	4,8	F0413999	●

Zubehör
Accessories



Schäfte
Shanks

» 746



Schnellwechsel-Einsätze Typenreihe EM
Quick-change adapters EM series

» 755 - 778

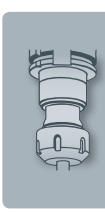

- Product Finder
- Soft-synchro
- Speed-synchro
- KSN
- MQL MMS
- SFM
- SWITCH-MASTER
- GR, GR-S**
- HF
- EM
- Zubehör Accessories
- Tech. Info

Schäfte Shanks

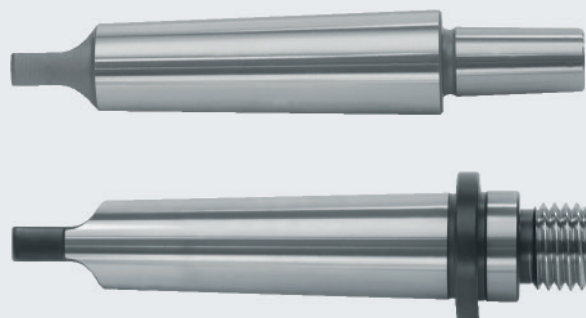
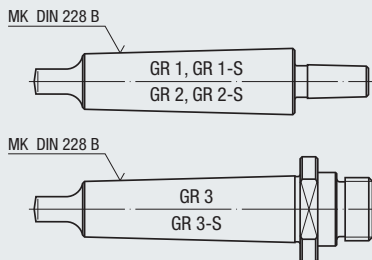

Für Typ For type	MK	Artikel-Nr. Article no.	
GR 1, GR 1-S GR 2, GR 2-S	MK 1	F040101.01	●
	MK 2	F040101.02	●
	MK 3	F040101.03	●
	MK 4	F040101.04	●
GR 3, GR 3-S	MK 2	F040301.02	●
	MK 3	F040301.03	●
	MK 4	F040301.04	●

Weitere Schäfte auf Anfrage
Further shanks upon request

Rubber-Flex-Spannzangen Rubber-Flex collets

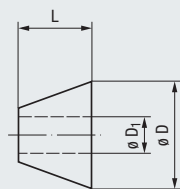

Für Typ For type	Zangengröße Collet size	L	ø D	ø D ₁	Artikel-Nr. Article no.	
GR 1	J115	12	15	1 - 2,5	F0940001	●
	J116 ¹⁾	12	15	2,5 - 4,5	F0940002	●
	J117 ¹⁾	12	15	4,5 - 6,5	F0940003	●
GR 2	J423	12,7	23	2 - 4,5	F0940004	●
	J421 ¹⁾	12,7	23	3,5 - 6,5	F0940006	●
	J422 ¹⁾	12,7	23	6,5 - 10	F0940007	●
GR 3	R30 ¹⁾	15	28	6 - 10,5	F0940015	●
	R32 ¹⁾	15	28	10,5 - 16	F0940019	●

¹⁾ Diese Größen sind im Lieferumfang enthalten
These sizes are included in the delivery

Gewindespindel komplett Thread spindle, complete



Für Typ For type	Artikel-Nr. Article no.	
GR 1	F040157.03	●
GR 2	F040257.03	●
GR 3	F040357.02	●

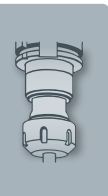

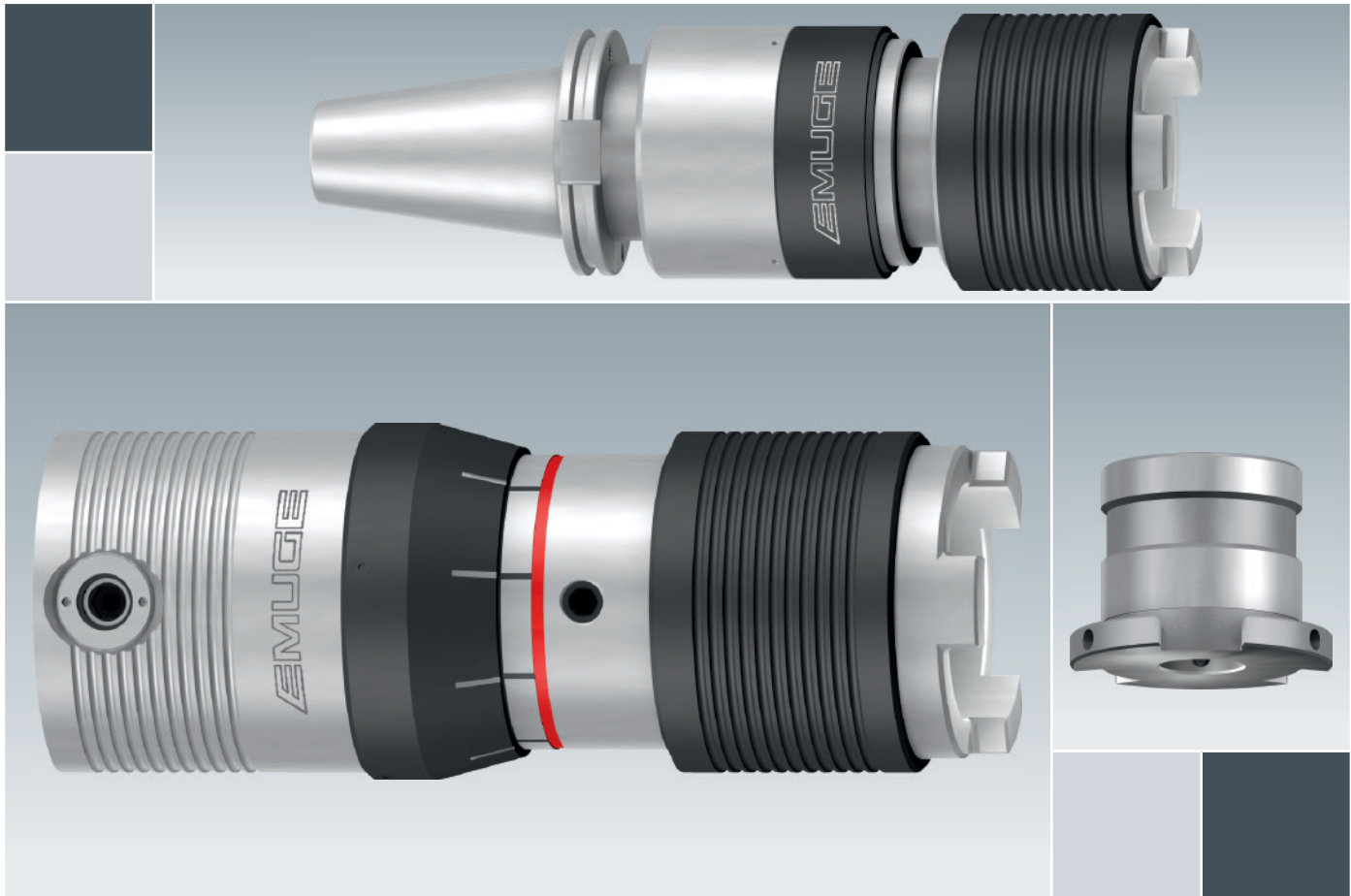

Typenreihe HF HF Series

Einsatz auf CNC-Bearbeitungszentren und Bohrwerken

Zur Herstellung von großen Gewinden bis M160. Je nach Typ mit Sicherheitsfunktionen wie einstellbarer Überlastkupplung und großem Längenausgleich ausgestattet.

Application on CNC machining centres and boring mills

For the production of big threads up to M160. Depending on the type: equipped with safety functions just like adjustable overload clutch and large length compensation.



- Product Finder
- Soft-synchro
- Speed-synchro
- KSN
- MQL MMS
- SFM
- SWITCH-MASTER
- GR, GR-S
- HF**
- EM
- Zubehör Accessories
- Tech. Info

HF

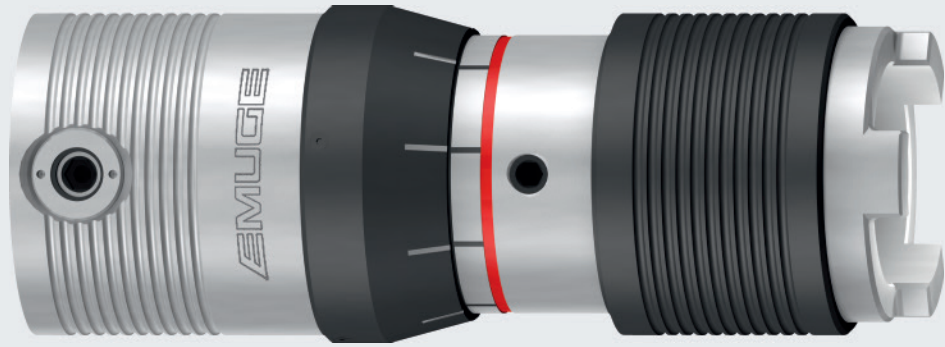

p_{max}
50bar
(700psi)

p_{max}
6bar
(85psi)

Schäfte siehe Seite 749
Shanks see page 749

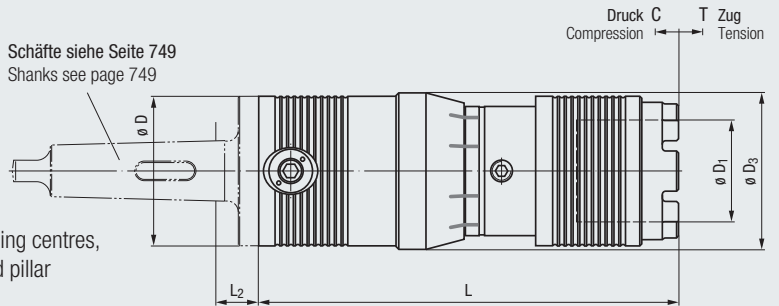

Einsatz auf CNC-Bearbeitungszentren,
sonstigen Werkzeugmaschinen und
Säulenbohrmaschinen

For use on CNC machining centres,
other machine tools and pillar
drilling machines

Typ Type			Max. Drehmoment Max. torque Nm ¹⁾	Geometrie						Gewicht Weight (kg)	Artikel-Nr. Article no.	
				Ø D	Ø D ₁	Ø D ₃	L	C	T			
HF 20	M24 - M76 (1" - 2 1/2")	HE 2	1300	110	75	115	308	15	15	14,8	F0332999	●
HF 30	M36 - M160 (1 3/8" - 3 1/2")	HE 3	3000	160	90	160	372	20	20	36,5	F0333999	●

¹⁾ Maximal zulässiger Drehmoment-Wert
Maximum permissible torque

Ausführung mit innerer Kühlschmierstoff-Zufuhr bis 10 bar auf Anfrage erhältlich
Available with internal coolant supply up to 10 bar upon request

Zubehör Accessories



Schnellwechsel-Einsätze Typ HE
Quick-change adapters, type HE

» 752 - 753



Schäfte Typ HF
Shanks type HF

» 749

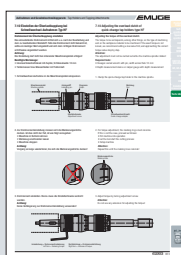

Einstellen der Überlastkupplung bei
Schnellwechsel-Aufnahmen Typ HF
siehe Seite 833 - 834

Adjusting the overload clutch of
quick-change tap holders type HF,
see page 833 - 834

Für Typ For type	SK	L ₂	Gewicht Weight (kg)	Artikel-Nr. Article no.	
HF 20	SK 50	66	3,8	F033206.02	●
HF 30	SK 50	51	5,8	F033306.01	●

Ausführung mit innerer Kühlschmierstoff-Zufuhr
bis 10 bar auf Anfrage erhältlich
Available with internal coolant supply
up to 10 bar upon request



HF
DIN 69871 A

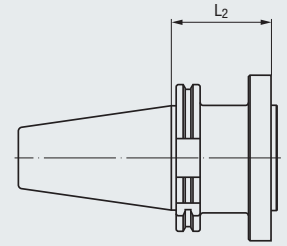

Für Typ For type	SK	L ₂	Gewicht Weight (kg)	Artikel-Nr. Article no.	
HF 20	SK 40	22	1,7	F033205.05	●
	SK 50	18	3,0	F033205.01	●
HF 30	SK 50	19	4,3	F033305.01	●

Ausführung mit innerer Kühlschmierstoff-Zufuhr
bis 10 bar auf Anfrage erhältlich
Available with internal coolant supply
up to 10 bar upon request

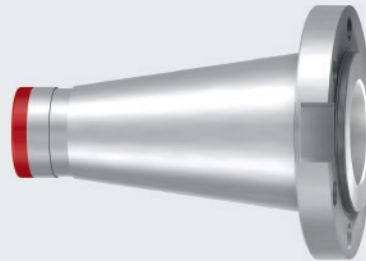

HF
DIN 2080

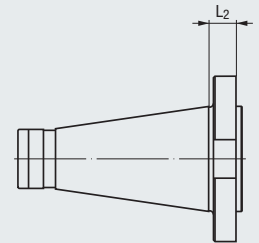

Für Typ For type	BT	L ₂	Gewicht Weight (kg)	Artikel-Nr. Article no.	
HF 20	BT 50	85	4,7	F033208.02	●
HF 30	BT 50	166	6,7	F033308.01	○

Ausführung mit innerer Kühlschmierstoff-Zufuhr
bis 10 bar auf Anfrage erhältlich
Available with internal coolant supply
up to 10 bar upon request

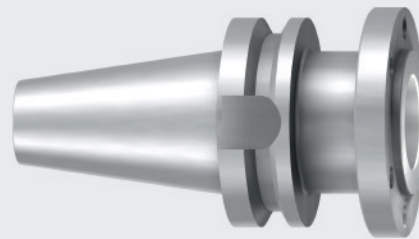

HF
JIS B 6339
(MAS 403 BT)

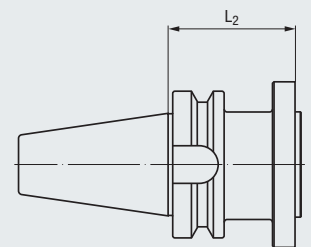

Für Typ For type	MK	L ₂	Gewicht Weight (kg)	Artikel-Nr. Article no.	
HF 20	MK 4	34	1,7	F033201.04	●
	MK 5	32	2,8	F033201.05	●
	MK 6	31	4,8	F033201.06	●
HF 30	MK 5	30	3,9	F033301.01	●
	MK 6	32	6,2	F033301.02	●

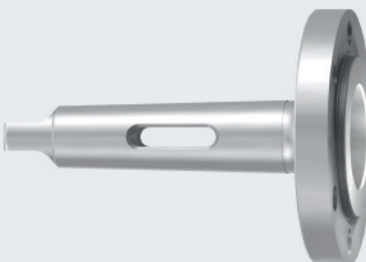

HF
DIN 228 B

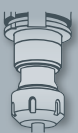
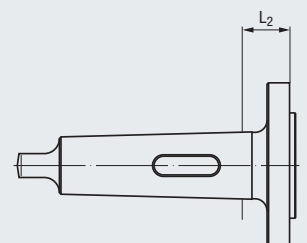

- Product Finder
- Soft-synchro
- Speed-synchro
- KSN
- MQL MMS
- SFM
- SWITCH-MASTER
- GR, GR-S
- HF
- EM
- Zubehör Accessories
- Tech. Info

HF/HD/Spezial

DIN 69871 AD
DIN 69871 B



IKZ



MMS
MQL

p_{max}
50bar
(700psi)

p_{max}
6bar
(85psi)



C T



F













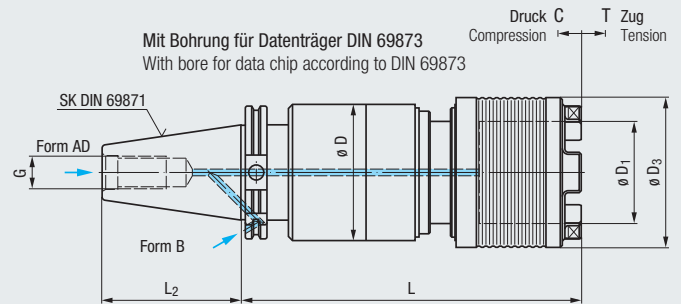



Einsatz auf CNC-Bearbeitungszentren und sonstigen Werkzeugmaschinen

For use on CNC machining centres and other machine tools

Typ Type			SK	ϕD	ϕD_1	ϕD_3	L	L ₂	G	C	T	Gewicht Weight (kg)	Artikel-Nr. Article no.	
HF 20/HD/Spezial	M24 - M76 (1" - 2 1/2)	HE 2/IKZZ	SK 50 AD	100	75	110	250	101,75	M24	15	15	12	F0332653.1.49	●
			SK 50 B	100	75	110	250	101,75	M24	15	15	12	F0332653.2.49	○

Weitere Ausführungen auf Anfrage
Further designs upon request

Zubehör Accessories



Schnellwechsel-Einsätze Typ HE/IKZZ
Quick-change adapters, type HE/IKZZ ▶ 752

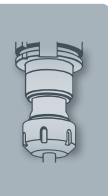

Spannzangen-Aufnahmen der Typenreihe Softsynchro® zur synchronen Herstellung von großen Gewinden siehe Seite 665 und 676

Collet holders of our Softsynchro® series for the synchronous production of large threads, see pages 665 and 676

HF/HD/Spezial

JIS B 6339
(MAS 403 BT)

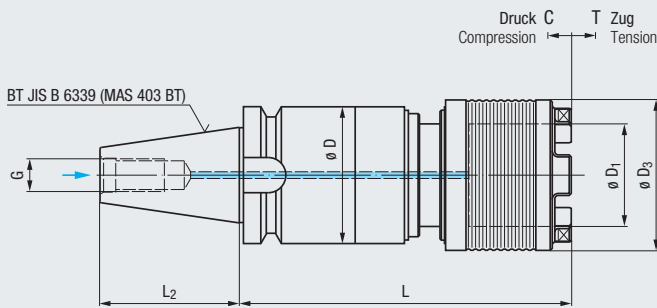



Einsatz auf CNC-Bearbeitungszentren
und sonstigen Werkzeugmaschinen

For use on CNC machining centres
and other machine tools



- Product Finder
- Soft-synchro
- Speed-synchro
- KSN
- ML MMS
- SFM
- SWITCH-MASTER
- GR, GR-S
- HF**
- EM
- Zubehör Accessories
- Tech. Info

Typ Type			BT	ϕD	ϕD_1	ϕD_3	L	L_2	G	C	T	Gewicht Weight (kg)	Artikel-Nr. Article no.
HF 20/HD/Spezial	M24 - M76 (1" - 2 1/2")	HE 2/IKZZ	BT 50	100	75	110	248	101,8	M24	15	15	12	F0332893.1.49

Weitere Ausführungen auf Anfrage
Further designs upon request

Zubehör Accessories



Schnellwechsel-Einsätze Typ HE/IKZZ
Quick-change adapters, type HE/IKZZ  752

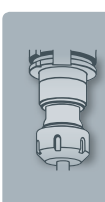

- Product Finder
- Soft-synchro
- Speed-synchro
- KSN
- MQL MMS
- SFM
- SWITCH-MASTER
- GR, GR-S
- HF
- EM
- Zubehör Accessories
- Tech. Info

HE 2/IKZZ

Für Gewindebohrer/Gewindeformer
For taps/cold-forming taps



p_{max}
50bar
(700psi)

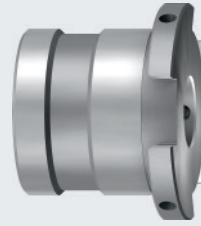
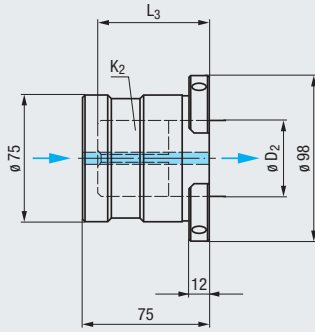

DIN						ISO					
$\emptyset D_2$	K_2		L_3	Gewicht Weight (kg)	Artikel-Nr. Article no.	$\emptyset D_2$	K_2		L_3	Gewicht Weight (kg)	Artikel-Nr. Article no.
18	14,5	M24	53	2,2	F0632115.6 ●	18	14	M24	53	2,2	F0632218.6 ●
20	16	M27	53	2,2	F0632116.6 ●	20	16	M27 - M30	53	2,2	F0632116.6 ●
22	18	M30	53	2,1	F0632117.6 ●	22,4	18	M33	53	2,1	F0632220.6 ●
25	20	M33	53	2,1	F0632118.6 ●	25	20	M36	53	2,1	F0632118.6 ●
28	22	M36	53	2,1	F0632119.6 ●	28	22,4	M39 - M42	53	2,1	F0632222.6 ●
32	24	M39 - M42	53	2,0	F0632120.6 ●	31,5	25	M45 - M48	53	2,0	F0632223.6 ●
36	29	M45 - M48	66	1,9	F0632121.6 ●	35,5	28	M52 - M56	66	1,9	F0632224.6 ●
40	32	M52 - M56	66	1,8	F0632122.6 ●	40	31,5	M60 - M64	66	1,8	F0632225.6 ●
45	35	M60	66	1,7	F0632123.6 ●	45	35,5	M68 - M75	66	1,7	F0632226.6 ●
50	39	M64 - M76 / M80 1) - M90 1)	66	1,6	F0632124.6 ●	50	40	M76 / M80 1) - M90 1)	66	1,6	F0632227.6 ●
56	44	M92 1) - M120 1)	66	1,4	F0632125.6 ●	56	45	M92 1) - M100 1)	66	1,4	F0632228.6 ●

1) Feingewinde
Fine threads

HE 2

Zum Bohren und Senken
For drilling and countersinking



p_{max}
50bar
(700psi)

Innenkegel nach DIN 228 B
Internal taper acc. DIN 228 B

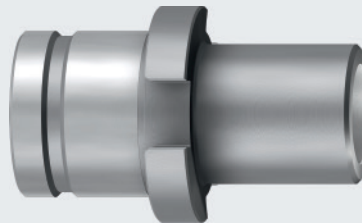
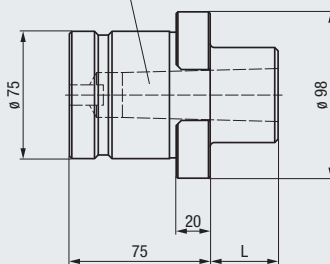

Innenkegel Internal taper		Gewicht Weight (kg)	Artikel-Nr. Article no.
MK	L		
MK 3	25	3,2	F0642803 ●
MK 4	48	3,3	F0642804 ●
MK 5	80	3,4	F0642805 ●

Für Gewindebohrer/Gewindeformer
For taps/cold-forming taps

HE 3

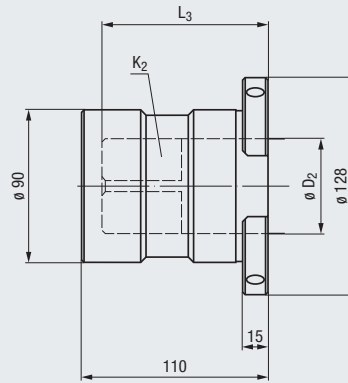
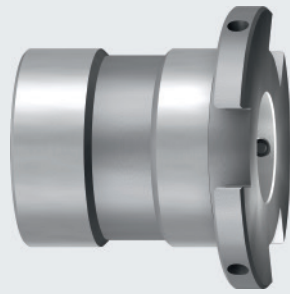

- Product Finder
- Soft-synchro
- Speed-synchro
- KSN
- MQL MMS
- SFM
- SWITCH-MASTER
- GR, GR-S
- HF
- EM
- Zubehör Accessories
- Tech. Info

DIN						ISO					
ø D ₂	K ₂		L ₃	Gewicht Weight (kg)	Artikel-Nr. Article no.	ø D ₂	K ₂		L ₃	Gewicht Weight (kg)	Artikel-Nr. Article no.
28	22	M36	76	4,4	F0633119 ●	28	22,4	M39 - M42	76	2,1	F0633222 ●
32	24	M39 - M42	76	4,3	F0633120 ●	31,5	25	M45 - M48	76	2,0	F0633223 ●
36	29	M45 - M48	76	4,2	F0633121 ●	35,5	28	M52 - M56	76	1,9	F0633224 ●
40	32	M52 - M56	76	4,0	F0633122 ●	40	31,5	M60 - M64	76	1,8	F0633225 ●
45	35	M60	76	3,9	F0633123 ●	45	35,5	M68 - M75	76	1,7	F0633226 ●
50	39	M64 - M90	76	3,7	F0633124 ●	50	40	M76 - M90	76	1,6	F0633227 ●
56	44	M92 - M120	98	3,4	F0633125 ●	56	45	M92 - M100	98	1,4	F0633228 ●
63	49	M122 - M150	98	3,0	F0633126 ●						
70	55	M155 - M160	98	2,7	F0633127 ●						

DIN- oder ISO-Ausführungen mit innerer Kühlschmierstoff-Zufuhr bis 10 bar auf Anfrage erhältlich
DIN or ISO designs available with internal coolant supply up to 10 bar upon request

Zum Bohren und Senken
For drilling and countersinking

HE 3

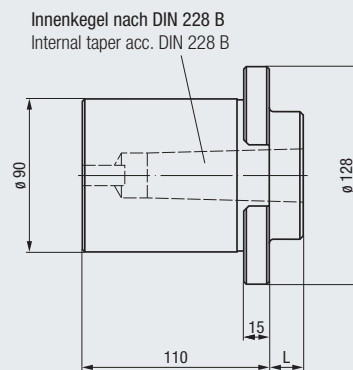
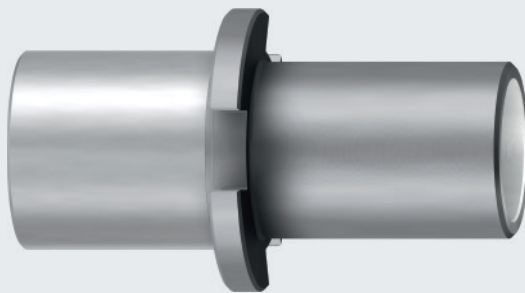

Innenkegel Internal taper	L	Gewicht Weight (kg)	Artikel-Nr. Article no.
MK			
MK 4	20	5,9	F0643804 ●
MK 5	50	6,0	F0643805 ●
MK 6	115	5,8	F0643806 ●



- Product Finder
- Soft-synchro
- Speed-synchro
- KSN
- MQL MMS
- SFM
- SWITCH-MASTER
- GR, GR-S
- HF**
- EM
- Zubehör Accessories
- Tech. Info

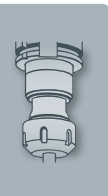



Typenreihe EM EM Series

Passend zu all unseren Schnellwechsel-Aufnahmen der Typenreihen KSN, SFM und GR-S

Je nach Typ mit Kühlschmierstoff-Zufuhr durch das Zentrum des Werkzeugs oder am Schaft entlang, Überlastkupplung und Längennachstellung.

Die Spannung des Werkzeugs erfolgt je nach Typ durch ein Kugelspannsystem, Spannzangen Typ ER (GB), Spannzangen Typ PGR (GB) oder durch unser E-Lock-System.

Suitable for all our quick-change tap holders of KSN, SFM and GR-S series

Depending on the type: with coolant supply through the tool centre or along the shank, overload clutch and length adjustment.

Clamping of the tool is achieved – depending on the type – by a ball clamping system, collets type ER (GB), collets type PGR (GB) or by our E-Lock system.



- Product Finder
- Soft-synchro
- Speed-synchro
- KSN
- MQL MMS
- SFM
- SWITCH-MASTER
- GR, GR-S
- HF
- EM**
- Zubehör Accessories
- Tech. Info

		Werkzeug-Adaptierung Tool adaptation			Funktionen Functions		
DIN	ISO						
		Schnellwechsel-Kugelspannsystem oder Klemmung am Vierkant Quick-change ball clamping system or clamping on the square	Spannzangen, Typ ER (GB) Collets, type ER (GB)	Spannzangen, Typ PGR (GB) Collets, type PGR (GB)	Überlastkupplung Overload clutch	Längeneinstellung Length adjustment	Arretierung über formschlüssige Rille am Vierkant Locking with form-positive slot on the square

Seite · Page

EM	758	759	■					
EM-E	760	760	■					
EM/IKZ	761		■					
EM-E-Lock	762	763	■					■
EM-U	764	765	■			■		
EM-U-E	766	766	■			■		
EM-U/IKZ	767		■			■		
EM-L	768	769	■				■	
EM-L-E	770	770	■				■	
EM-UL	771	772	■			■	■	
EM-UL-E	773	773	■			■	■	
EM-Z/ER/IKZ	774			■				
EM-L/ER/IKZ	775			■			■	
EM/PGR/IKZ	776				■			
EM-SE	777							
EM-R	778							

Symbolbeschreibung der Leistungsmerkmale
Description of the symbols for performance characteristics [» 804 - 811](#)

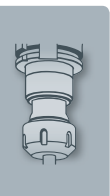

- Product Finder
- Soft-synchro
- Speed-synchro
- KSN
- MQL MMS
- SFM
- SWITCH-MASTER
- GR, GR-S
- HF
- EM**
- Zubehör Accessories
- Tech. Info

EM DIN

p_{max}
50bar
(700psi)

p_{max}
6bar
(85psi)

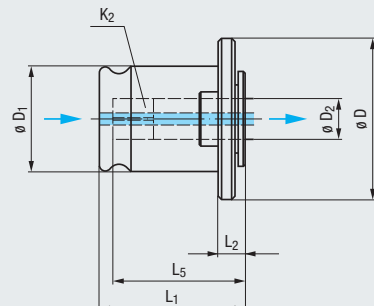
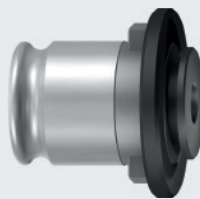

Typ · Type	EM 00/DIN	EM 01/DIN	EM 03/DIN	EM 04/DIN	EM 05/DIN
	M1 - M10	M3 - M14	M4,5 - M24	M14 - M36	M22 - M48
ϕD	23	30	48	70	92
ϕD_1	13	19	31	48	60
L_1	27	29	45	67	111
L_2	7	7	10	11	48

DIN				Artikel-Nr. Article no.		Artikel-Nr. Article no.		Artikel-Nr. Article no.		Artikel-Nr. Article no.		Artikel-Nr. Article no.			
ϕD_2	K_2				L_5		L_5		L_5		L_5		L_5		
2,5	2,1	M1 - M1,8	M3,5	F0560100	20	●									
2,8	2,1	M2 - M2,6	M4	F0560101	20	●									
3,5	2,7	M3	M4,5 - M5	F0560102	21	●	F0561102	23	●						
4	3	M3,5	M5,5	F0560103	21	●	F0561103	23	●						
4,5	3,4	M4	M6	F0560104	21	●	F0561104	23	●						
6	4,9	M4,5 - M6	M8	F0560106	23	●	F0561106	25	●	F0563106	37	●			
7	5,5	M7	M9 - M10	F0560107	23	●	F0561107	25	●	F0563107	37	●			
8	6,2	M8	M11	2)			F0561108	26	●	F0563108	38	●			
9	7	M9	M12				F0561109	27	●	F0563109	39	●			
10	8	M10					F0561110	27	●	F0563110	40	●			
11	9		M14				F0561111	27	●	F0563111	41	●	F0564111	53	●
12	9		M16				2)			F0563112	41	●	F0564112	53	●
14	11		M18							F0563113	43	●	F0564113	55	●
16	12		M20							F0563114	44	●	F0564114	56	●
18	14,5		M22 - M24							F0563115	44	●	F0564115	58	●
20	16		M27							2)			F0564116	60	●
22	18		M30							2)			F0564117	62	●
25	20		M33										F0564118	64	●
28	22		M36										F0564119	66	●
32	24		M39 - M42							2)			F0565120	104	●
36	29		M45 - M48							2)			F0565121	109	●
40	32		M52 - M56										2)		
45	35		M68										2)		

1) Bei Verwendung von Gewindebohrern / Gewindeformern mit innerer Kühlschmierstoff-Zufuhr
If used with taps / cold-forming taps with internal coolant supply

2) Schnellwechsel-Einsätze mit erweitertem Spannereich Typ EM-E siehe Seite 760
Quick-change adapters with extended clamping range type EM-E, see page 760

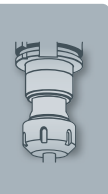

EM
ISO

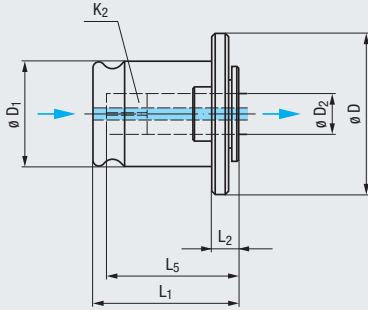
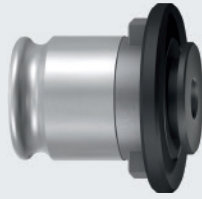

- Product Finder
- Soft-synchro
- Speed-synchro
- KSN
- MQL MMS
- SFM
- SWITCH-MASTER
- GR, GR-S
- HF
- EM**
- Zubehör Accessories
- Tech. Info

Typ - Type	EM 00/ISO	EM 01/ISO	EM 03/ISO	EM 04/ISO	EM 05/ISO
	M1 - M9	M3,5 - M14	M6 - M24	M14 - M42	M24 - M48
$\varnothing D$	23	30	48	70	92
$\varnothing D_1$	13	19	31	48	60
L_1	27	29	45	67	111
L_2	7	7	10	11	48

ISO				Artikel-Nr. Article no.	L_5	●	○	Artikel-Nr. Article no.	L_5	●	○	Artikel-Nr. Article no.	L_5	●	○	Artikel-Nr. Article no.	L_5	●	○
2,24	1,8		M3	F0560200	19	●													
2,5	2	M1 - M2	M3,5	F0560201	19	●													
2,8	2,24	M2,2 - M2,5		F0560202	20	●													
3,15	2,5	M3	M4	F0560203	20	●													
3,55	2,8	M3,5	M4,5	F0560204	20	●	F0561204	22	●										
4	3,15	M4	M5	F0560205	21	●	F0561205	23	●										
4,5	3,55	M4,5	M6	F0560206	21	●	F0561206	23	●										
5	4	M5		F0560207	22	●	F0561207	24	●										
5,6	4,5		M7	F0560208	22	●	F0561208	24	●										
6,3	5	M6	M8	F0560209	23	●	F0561209	25	●	F0563209	37	●							
7,1	5,6	M7	M9	F0560210	23	●	F0561210	25	●	F0563210	37	●							
8	6,3	M8	M10 - M11	2)			F0561211	26	●	F0563211	38	●							
9	7,1	M9	M12				F0561212	27	●	F0563212	39	●							
10	8	M10					F0561110	27	●	F0563110	40	●							
11,2	9		M14				F0561214	27	●	F0563214	41	●	F0564214	53	●				
12,5	10		M16				2)			F0563215	42	●	F0564215	54	●				
14	11,2		M18 - M20							F0563216	43	●	F0564216	55	●				
16	12,5		M22							F0563217	43	●	F0564217	57	●				
18	14		M24							F0563218	43	●	F0564218	59	●	F0565218	95	●	
20	16		M27 - M30				2)						F0564116	61	●	F0565116	97	●	
22,4	18		M33				2)						F0564220	63	●	F0565220	99	●	
25	20		M36										F0564118	65	●	F0565118	101	●	
28	22,4		M39 - M42										F0564222	66	●	F0565222	103	●	
31,5	25		M45 - M48										2)			F0565223	105	●	
35,5	28		M52 - M56										2)			2)			
40	31,5		M60 - M64													2)			
45	35,5		M68													2)			

1) Bei Verwendung von Gewindebohrern / Gewindeformern mit innerer Kühlschmierstoff-Zufuhr
If used with taps / cold-forming taps with internal coolant supply

2) Schnellwechsel-Einsätze mit erweitertem Spannbereich Typ EM-E siehe Seite 760
Quick-change adapters with extended clamping range type EM-E, see page 760

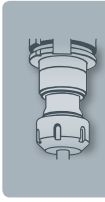

- Product Finder
- Soft-synchro
- Speed-synchro
- KSN
- MQL MMS
- SFM
- SWITCH-MASTER
- GR, GR-S
- HF
- EM
- Zubehör Accessories
- Tech. Info

EM-E

DIN
ISO

Zum Schneiden von Feingewinden **MF**
For the cutting of fine threads

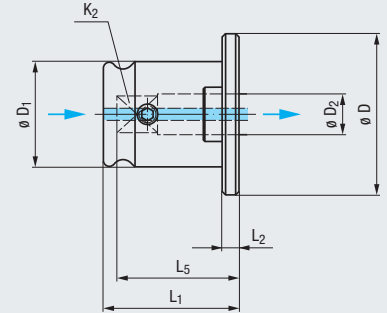
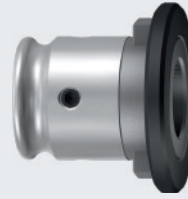

IKZ 1)

MMS
MQL

ρ_{max}
50bar
(700psi)

ρ_{max}
6bar
(85psi)

E-Lock

Typ · Type	EM 00-E	EM 01-E	EM 03-E	EM 04-E	EM 05-E
$\varnothing D$	23	30	48	70	92
$\varnothing D_1$	13	19	31	48	60
L_1	23,5	25,5	40	61,5	84
L_2	7	4	5	6	21

Typ · Type		EM 00-E/DIN		EM 01-E/DIN		EM 03-E/DIN		EM 04-E/DIN		EM 05-E/DIN			
Feingewinde Fine thread MF		M8 - M11		M16		M27 - M30		M39 - M48		M52 - M60			
DIN				Artikel-Nr. Article no.	L_5	Artikel-Nr. Article no.	L_5	Artikel-Nr. Article no.	L_5	Artikel-Nr. Article no.	L_5		
$\varnothing D_2$	K_2												
8	6,2	M8	M11	F0800108	21	●	F0801112	25	●				
12	9		M16										
20	16		M27				F0803116	39	●				
22	18		M30				F0803117	39	●				
32	24		M39 - M42						F0804120	61	●		
36	29		M45 - M48						F0804121	60	●		
40	32		M52 - M56								F0805122	83	●
45	35		M60								F0805123	83	●

Typ · Type		EM 00-E/ISO		EM 01-E/ISO		EM 03-E/ISO		EM 04-E/ISO		EM 05-E/ISO			
Feingewinde Fine thread MF		M8 - M11		M16		M27 - M33		M45 - M56		M52 - M68			
ISO				Artikel-Nr. Article no.	L_5	Artikel-Nr. Article no.	L_5	Artikel-Nr. Article no.	L_5	Artikel-Nr. Article no.	L_5		
$\varnothing D_2$	K_2												
8	6,3	M8	M10 - M11	F0800211	21	●	F0801215	25	●				
12,5	10		M16										
20	16		M27 - M30				F0803116	40	●				
22,4	18		M33				F0803220	39	●				
31,5	25		M45 - M48						F0804223	61	●		
35,5	28		M52 - M56						F0804224	61	●		
40	31,5		M60 - M64								F0805224	81	●
45	35,5		M68								F0805225	82	●
											F0805226	83	●

1) Bei Verwendung von Gewindebohrern mit innerer Kühlschmierstoff-Zufuhr
If used with taps with internal coolant supply

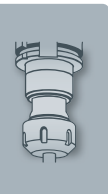

Für Gewindebohrer / Gewindeformer ohne innere Kühlschmierstoff-Zufuhr
For taps / cold-forming taps without internal coolant supply

EM/IKZ
DIN

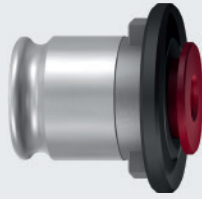

Entlang des Werkzeugschafts
Along the tool shank

p_{max}
50bar
(700psi)

p_{max}
6bar
(85psi)

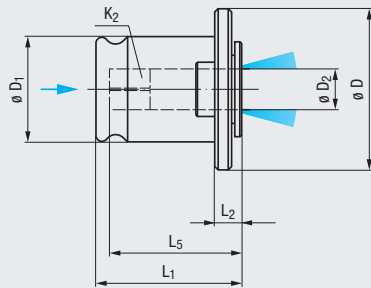

Typ · Type	EM 01/IKZ/DIN	EM 03/IKZ/DIN	EM 04/IKZ/DIN	EM 05/IKZ/DIN
	M3 - M14	M4,5 - M24	M14 - M36	M22 - M48
ø D	30	48	70	92
ø D ₁	19	31	48	60
L ₁	29	45	67	111
L ₂	7	10	11	48

DIN						Artikel-Nr. Article no.		Artikel-Nr. Article no.		Artikel-Nr. Article no.		Artikel-Nr. Article no.			
ø D ₂	K ₂				L ₅		L ₅		L ₅		L ₅		L ₅		
2,5	2,1	M1 - M1,8	M3,5												
2,8	2,1	M2 - M2,6	M4												
3,5	2,7	M3	M4,5 - M5	F0561102.5	23	●									
4	3	M3,5	M5,5	F0561103.5	23	●									
4,5	3,4	M4	M6	F0561104.5	23	●									
6	4,9	M4,5 - M6	M8	F0561106.5	25	●	F0563106.5	37	●						
7	5,5	M7	M9 - M10	F0561107.5	25	●	F0563107.5	37	●						
8	6,2	M8	M11	F0561108.5	26	●	F0563108.5	38	●						
9	7	M9	M12	F0561109.5	27	●	F0563109.5	39	●						
10	8	M10		F0561110.5	27	●	F0563110.5	40	●						
11	9		M14	F0561111.5	27	●	F0563111.5	41	●	F0564111.5	53	●			
12	9		M16				F0563112.5	41	●	F0564112.5	53	●			
14	11		M18				F0563113.5	43	●	F0564113.5	55	●			
16	12		M20				F0563114.5	44	●	F0564114.5	56	●			
18	14,5		M22 - M24				F0563115.5	44	●	F0564115.5	58	●	F0565115.5	94	●
20	16		M27							F0564116.5	60	●	F0565116.5	96	●
22	18		M30							F0564117.5	62	●	F0565117.5	98	●
25	20		M33							F0564118.5	64	●	F0565118.5	100	●
28	22		M36							F0564119.5	66	●	F0565119.5	102	●
32	24		M39 - M42										F0565120.5	104	●
36	29		M45 - M48										F0565121.5	109	●

● = Lagerwerkzeug, siehe Preisliste · Stock tool, see price list
○ = Kurzfristig lieferbar, Preis auf Anfrage · Available on short notice, price upon inquiry

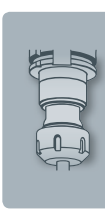

Product Finder

- Soft-synchro
- Speed-synchro
- KSN
- ML MMS
- SFM
- SWITCH-MASTER
- GR, GR-S
- HF
- EM**
- Zubehör Accessories
- Tech. Info

- Product Finder
- Soft-synchro
- Speed-synchro
- KSN
- MQL MMS
- SFM
- SWITCH-MASTER
- GR, GR-S
- HF
- EM
- Zubehör Accessories
- Tech. Info

EM-E-Lock

DIN

p_{max}
50bar
(700psi)

p_{max}
6bar
(85psi)

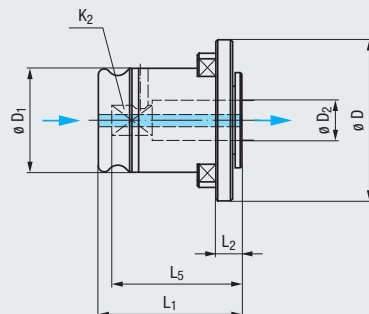
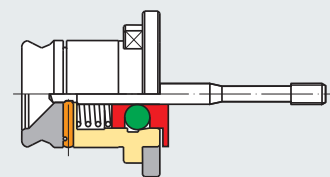
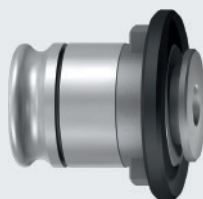

Typ · Type	EM 01-E-Lock/DIN	EM 03-E-Lock/DIN
	M3 - M14	M4,5 - M24
$\varnothing D$	30	48
$\varnothing D_1$	19	31
L_1	29	45
L_2	7	10

DIN				Artikel-Nr. Article no.	L_5	Rillenform Slot shape		Artikel-Nr. Article no.	L_5	Rillenform Slot shape	
$\varnothing D_2$	K_2										
3,5	2,7	M3	M4,5 - M5	F2561102	23	A	●				
4	3	M3,5	M5,5	F2561103	23	A	●				
4,5	3,4	M4	M6	F2561104	23	A	●				
6	4,9	M4,5 - M6	M8	F2561106	25	A	●	F2563106	37	A	●
7	5,5	M7	M9 - M10	F2561107	25	A	●	F2563107	37	A	●
8	6,2	M8	M11	F2561108	26	A	●	F2563108	38	A	●
9	7	M9	M12	F2561109	27	A	●	F2563109	39	A	●
10	8	M10		F2561110	27	A	●	F2563110	40	A	●
11	9		M14	F2561111	27	A	●	F2563111	41	A	●
12	9		M16					F2563112	41	B	●
14	11		M18					F2563113	43	B	●
16	12		M20					F2563114	44	B	●
18	14,5		M22 - M24					F2563115	44	B	●

1) Bei Verwendung von Gewindebohrern / Gewindefornern mit innerer Kühlschmierstoff-Zufuhr
If used with taps / cold-forming taps with internal coolant supply

Weitere Größen auf Anfrage
Further sizes upon request

Lehren und Rillenformen siehe Seite 763
Gauges and slot shapes, see page 763

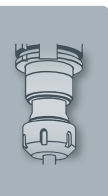

EM-E-Lock

ISO

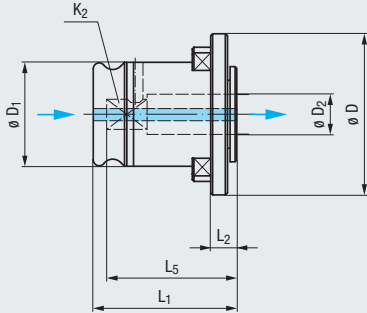
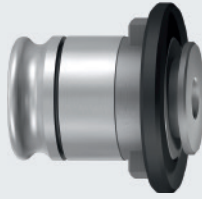
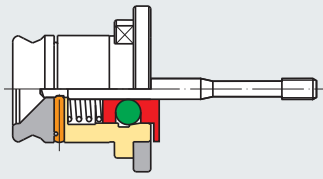

p_{max}
50bar
(700psi)

p_{max}
6bar
(85psi)

E-Lock

- Product Finder
- Soft-synchro
- Speed-synchro
- KSN
- ML MMS
- SFM
- SWITCH-MASTER
- GR, GR-S
- HF
- EM**
- Zubehör Accessories
- Tech. Info

Typ · Type	EM 01-E-Lock/ISO	EM 03-E-Lock/ISO
	M3,5 - M14	M6 - M24
$\varnothing D$	30	48
$\varnothing D_1$	19	31
L_1	29	45
L_2	7	10

ISO				Artikel-Nr. Article no.	L_5	Rillenform Slot shape		Artikel-Nr. Article no.	L_5	Rillenform Slot shape	
$\varnothing D_2$	K_2										
3,55	2,8	M3,5	M4,5	F2561204	22	A	●				
4	3,15	M4	M5	F2561205	23	A	●				
4,5	3,55	M4,5	M6	F2561206	23	A	●				
5	4	M5		F2561207	24	A	●				
5,6	4,5		M7	F2561208	24	A	●				
6,3	5	M6	M8	F2561209	25	A	●	F2563209	37	A	●
7,1	5,6	M7	M9	F2561210	25	A	●	F2563210	37	A	●
8	6,3	M8	M10 - M11	F2561211	26	A	●	F2563211	38	A	●
9	7,1	M9	M12	F2561212	27	A	●	F2563212	39	A	●
10	8	M10		F2561110	27	A	●	F2563110	40	A	●
11,2	9		M14	F2561214	27	A	●	F2563214	41	A	●
12,5	10		M16					F2563215	42	B	●
14	11,2		M18 - M20					F2563216	43	B	●
16	12,5		M22					F2563217	43	B	●
18	14		M24					F2563218	43	B	●

1) Bei Verwendung von Gewindebohrern / Gewindefornern mit innerer Kühlschmierstoff-Zufuhr
If used with taps / cold-forming taps with internal coolant supply

Weitere Größen auf Anfrage
Further sizes upon request

EM-E-Lock Rillenformen am Vierkant EM-E-Lock slot shapes on the driving square

Form A

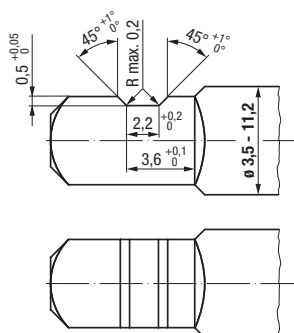

Form B

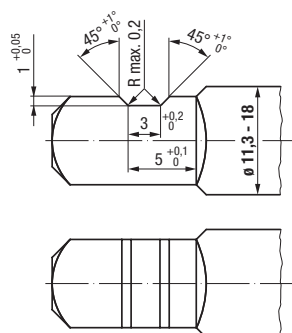

EM-E-Lock Lehren EM-E-Lock gauges



Typ Type	Für Rillenform For slot shape	Artikel-Nr. Article no.	
EM-E-Lock/A	A	F256199.02	●
EM-E-Lock/B	B	F256399.02	●

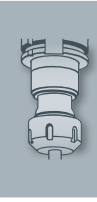

Mit Überlastkupplung
With overload clutch

EM-U

DIN

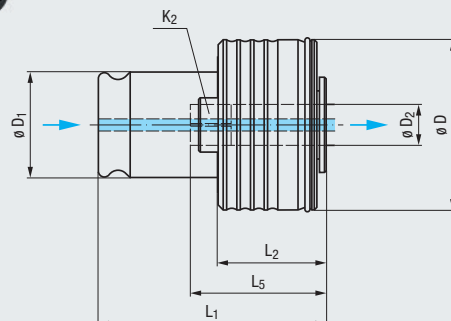

p_{max}
50bar
(700psi)

p_{max}
6bar
(85psi)

Typ · Type	EM 00-U/DIN	EM 01-U/DIN	EM 03-U/DIN	EM 04-U/DIN	EM 05-U/DIN
	M1 - M10	M3 - M14	M4,5 - M24	M14 - M36	M22 - M48
$\varnothing D$	24	33	50	72	95
$\varnothing D_1$	13	19	31	48	60
L_1	41,5	47	69	101	138
L_2	22	25	34	45	75

DIN				Artikel-Nr. Article no.	L ₅	Artikel-Nr. Article no.	L ₅	Artikel-Nr. Article no.	L ₅	Artikel-Nr. Article no.	L ₅	Artikel-Nr. Article no.	L ₅		
2,5	2,1	M1 - M1,8		F0570100.1	21	●									
2,5	2,1		M3,5	F0570100.2	21	●									
2,8	2,1	M2		F0570101.1	21	●									
2,8	2,1	M2,5		F0570101.2	21	●									
2,8	2,1		M4	F0570101.3	21	●									
3,5	2,7	M3		F0570102.1	22	●	F0571102.1	23	●						
3,5	2,7		M4,5 - M5	F0570102.2	22	●	F0571102.2	23	●						
4	3	M3,5		F0570103	22	●	F0571103	23	●						
4,5	3,4	M4		F0570104.1	22	●	F0571104.1	23	●						
4,5	3,4		M6	F0570104.2	22	●	F0571104.2	23	●						
6	4,9	M4,5 - M5		F0570106.1	24	●	F0571106.1	25	●	F0573106.1	38	●			
6	4,9	M6		F0570106.2	24	●	F0571106.2	25	●	F0573106.2	38	●			
6	4,9		M8	F0570106.3	24	●	F0571106.3	25	●	F0573106.3	38	●			
7	5,5		M10	F0570107	24	●	F0571107	25	●	F0573107	38	●			
8	6,2	M8		2)			F0571108	26	●	F0573108	39	●			
9	7		M12				F0571109	27	●	F0573109	40	●			
10	8	M10					F0571110	28	●	F0573110	41	●			
11	9		M14				F0571111	29	●	F0573111	42	●	F0574111	56	●
12	9		M16				2)			F0573112	42	●	F0574112	56	●
14	11		M18							F0573113	44	●	F0574113	58	●
16	12		M20							F0573114	45	●	F0574114	59	●
18	14,5		M22 - M24							F0573115	47	●	F0574115	61	●
20	16		M27							2)			F0574116	63	●
22	18		M30							2)			F0574117	65	●
25	20		M33										F0574118	67	●
28	22		M36										F0574119	69	●
32	24		M39 - M42							2)					
36	29		M45 - M48							2)					
40	32		M52 - M56												
45	35		M60												

1) Bei Verwendung von Gewindebohrern / Gewindefornern mit innerer Kühlschmierstoff-Zufuhr
If used with taps / cold-forming taps with internal coolant supply

2) Schnellwechsel-Einsätze mit erweitertem Spannbereich Typ EM-U-E siehe Seite 766
Quick-change adapters with extended clamping range type EM-U-E, see page 766

Mit Überlastkupplung
With overload clutch

EM-U
ISO

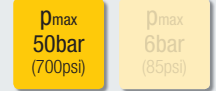
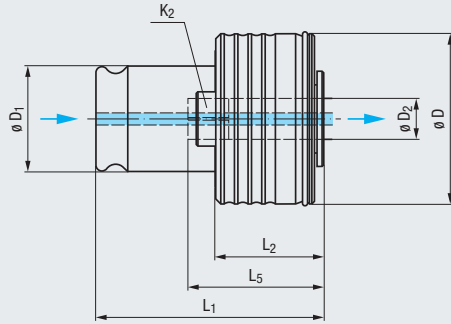
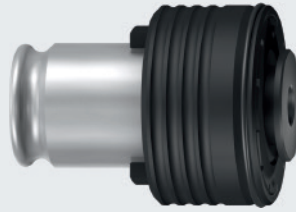

- Product Finder
- Soft-synchro
- Speed-synchro
- KSN
- MQL MMS
- SFM
- SWITCH-MASTER
- GR, GR-S
- HF
- EM**
- Zubehör Accessories

Tech. Info

Typ - Type	EM 00-U/ISO	EM 01-U/ISO	EM 03-U/ISO	EM 04-U/ISO	EM 05-U/ISO
	M2,2 - M9	M3,5 - M14	M6 - M24	M14 - M42	M24 - M48
$\varnothing D$	24	33	50	72	95
$\varnothing D_1$	13	19	31	48	60
L_1	41,5	47	69	101	138
L_2	22	25	34	45	75

ISO				Artikel-Nr. Article no.	L_5	Artikel-Nr. Article no.	L_5	Artikel-Nr. Article no.	L_5	Artikel-Nr. Article no.	L_5	Artikel-Nr. Article no.	L_5		
2,8	2,24	M2,2 - M2,5		F0570202	21	●									
3,15	2,5	M3		F0570203.1	21	●									
3,15	2,5		M4	F0570203.2	21	●									
3,55	2,8	M3,5		F0570204.1	21	●	F0571204.1	22	●						
3,55	2,8		M4,5	F0570204.2	21	●	F0571204.2	22	●						
4	3,15	M4		F0570205.1	22	●	F0571205.1	23	●						
4	3,15		M5	F0570205.2	22	●	F0571205.2	23	●						
4,5	3,55	M4,5		F0570206.1	22	●	F0571206.1	23	●						
4,5	3,55		M6	F0570206.2	22	●	F0571206.2	23	●						
5	4	M5		F0570207	23	●	F0571207	24	●						
5,6	4,5		M7	F0570208	23	●	F0571208	24	●						
6,3	5	M6		F0570209.1	24	●	F0571209.1	25	●	F0573209.1	38	●			
6,3	5		M8	F0570209.2	24	●	F0571209.2	25	●	F0573209.2	38	●			
7,1	5,6	M7	M9	F0570210	24	●	F0571210	25	●	F0573210	38	●			
8	6,3	M8	M10 - M11	2)			F0571211	26	●	F0573211	39	●			
9	7,1	M9	M12				F0571212	27	●	F0573212	40	●			
10	8	M10					F0571110	28	●	F0573110	41	●			
11,2	9		M14				F0571214	29	●	F0573214	42	●	F0574214	56	●
12,5	10		M16				2)			F0573215	43	●	F0574215	57	●
14	11,2		M18 - M20							F0573216	44	●	F0574216	58	●
16	12,5		M22							F0573217	46	●	F0574217	60	●
18	14		M24							F0573218	48	●	F0574218	62	●
20	16		M27 - M30							2)			F0574116	64	●
22,4	18		M33							2)			F0574220	66	●
25	20		M36										F0574118	67	●
28	22,4		M39 - M42										F0574222	70	●
31,5	25		M45 - M48							2)					●
35,5	28		M52 - M56							2)					●
40	31,5		M60 - M64												●
45	35,5		M68												●

1) Bei Verwendung von Gewindebohrern / Gewindefornern mit innerer Kühlschmierstoff-Zufuhr
If used with taps / cold-forming taps with internal coolant supply

2) Schnellwechsel-Einsätze mit erweitertem Spannbereich Typ EM-U-E siehe Seite 766
Quick-change adapters with extended clamping range type EM-U-E, see page 766

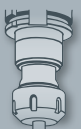

- Product Finder
- Soft-synchro
- Speed-synchro
- KSN
- MQL MMS
- SFM
- SWITCH-MASTER
- GR, GR-S
- HF
- EM
- Zubehör Accessories
- Tech. Info

EM-U-E

DIN
ISO

p_{max}
50bar
(700psi)

p_{max}
6bar
(85psi)

Zum Schneiden von Feingewinden **MF**
For the cutting of fine threads

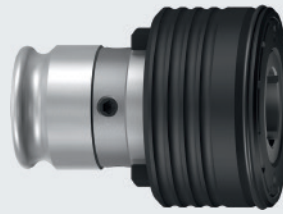

Mit Überlastkupplung
With overload clutch

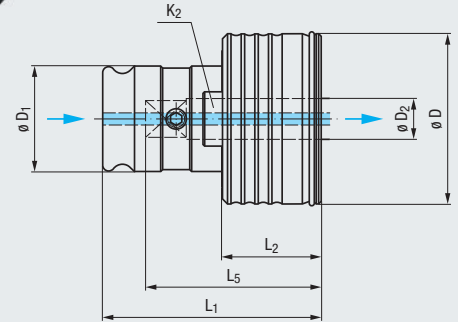

Typ · Type	EM 00-U-E	EM 01-U-E	EM 03-U-E	EM 04-U-E	EM 05-U-E
$\varnothing D$	24	33	50	72	95
$\varnothing D_1$	13	19	31	48	60
L_1	38,5	44	64,5	96	125
L_2	19	22,5	29,5	40,5	62

Typ · Type		EM 00-U-E/DIN		EM 01-U-E/DIN		EM 03-U-E/DIN		EM 04-U-E/DIN		EM 05-U-E/DIN	
Feingewinde Fine thread MF		M8 - M11		M16		M27 - M30		M39 - M48		M52 - M60	
DIN		$\varnothing D_2$	K_2	Artikel-Nr. Article no.	L_5	Artikel-Nr. Article no.	L_5	Artikel-Nr. Article no.	L_5	Artikel-Nr. Article no.	L_5
8	6,2	M8	M11	F0810108	28	F0811112	37	F0813116	50	F0814120	66
12	9		M16			F0813117	52	F0814121	71	F0815122	91
20	16		M27							F0815123	94
22	18		M30								
32	24		M39 - M42								
36	29		M45 - M48								
40	32		M52 - M56								
45	35		M60								

Typ · Type		EM 00-U-E/ISO		EM 01-U-E/ISO		EM 03-U-E/ISO		EM 04-U-E/ISO		EM 05-U-E/ISO	
Feingewinde Fine thread MF		M8 - M11		M16		M27 - M33		M45 - M56		M52 - M68	
ISO		$\varnothing D_2$	K_2	Artikel-Nr. Article no.	L_5	Artikel-Nr. Article no.	L_5	Artikel-Nr. Article no.	L_5	Artikel-Nr. Article no.	L_5
8	6,3	M8	M10 - M11	F0810211	28	F0811215	38	F0813116	50	F0814223	69
12,5	10		M16			F0813220	53	F0814224	72	F0815224	96
20	16		M27 - M30							F0815225	103
22,4	18		M33							F0815226	107
31,5	25		M45 - M48								
35,5	28		M52 - M56								
40	31,5		M60 - M64								
45	35,5		M68								

1) Bei Verwendung von Gewindebohrern mit innerer Kühlschmierstoff-Zufuhr
If used with taps with internal coolant supply

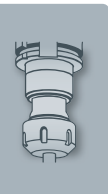

Für Gewindebohrer / Gewindeformer ohne innere Kühlschmierstoff-Zufuhr
For taps / cold-forming taps without internal coolant supply

EM-U/IKZ
DIN

Mit Überlastkupplung
With overload clutch

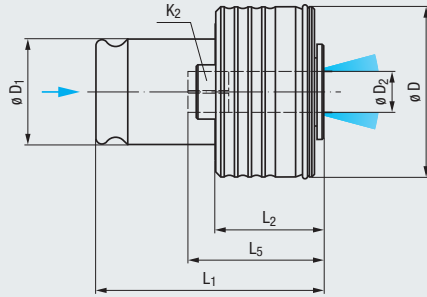
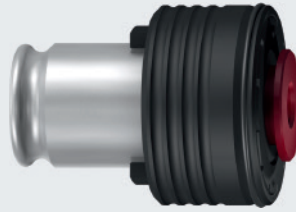

Entlang des Werkzeugschafts
Along the tool shank















- Product Finder
- Soft-synchro
- Speed-synchro
- KSN
- MQL MMS
- SFM
- SWITCH-MASTER
- GR, GR-S
- HF
- EM**
- Zubehör Accessories
- Tech. Info

Typ · Type	EM 01-U/IKZ/DIN	EM 03-U/IKZ/DIN	EM 04-U/IKZ/DIN	EM 05-U/IKZ/DIN
	M3 - M14	M4,5 - M24	M14 - M36	M22 - M48
$\varnothing D$	33	50	72	95
$\varnothing D_1$	19	31	48	60
L_1	47	69	101	138
L_2	25	34	45	75

DIN				Artikel-Nr. Article no.		Artikel-Nr. Article no.		Artikel-Nr. Article no.		Artikel-Nr. Article no.	
$\varnothing D_2$	K_2			L ₅		L ₅		L ₅		L ₅	
2,5	2,1	M1 - M1,8	M3,5								
2,8	2,1	M2 - M2,5	M4								
3,5	2,7	M3		F0571102.1.5	22 ●						
3,5	2,7		M4,5 - M5	F0571102.2.5	22 ●						
4	3	M3,5		F0571103.5	22 ●						
4,5	3,4	M4		F0571104.1.5	23 ●						
4,5	3,4		M6	F0571104.2.5	23 ●						
6	4,9	M4,5 - M5		F0571106.1.5	25 ●	F0573106.1.5	38 ●				
6	4,9	M6		F0571106.2.5	25 ●	F0573106.2.5	38 ●				
6	4,9		M8	F0571106.3.5	25 ●	F0573106.3.5	38 ●				
7	5,5		M10	F0571107.5	25 ●	F0573107.5	38 ●				
8	6,2	M8		F0571108.5	26 ●	F0573108.5	39 ●				
9	7		M12	F0571109.5	27 ●	F0573109.5	40 ●				
10	8	M10		F0571110.5	28 ●	F0573110.5	41 ●				
11	9		M14	F0571111.5	29 ●	F0573111.5	42 ●	F0574111.5	56 ●		
12	9		M16			F0573112.5	42 ●	F0574112.5	56 ●		
14	11		M18			F0573113.5	44 ●	F0574113.5	58 ●		
16	12		M20			F0573114.5	45 ●	F0574114.5	59 ●		
18	14,5		M22 - M24			F0573115.5	47 ●	F0574115.5	61 ●	F0575115.5	94 ●
20	16		M27					F0574116.5	63 ●	F0575116.5	96 ●
22	18		M30					F0574117.5	65 ●	F0575117.5	98 ●
25	20		M33					F0574118.5	67 ●	F0575118.5	100 ●
28	22		M36					F0574119.5	69 ●	F0575119.5	102 ●
32	24		M39 - M42							F0575120.5	104 ●
36	29		M45 - M48							F0575121.5	109 ●

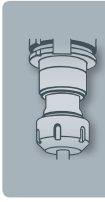
● = Lagerwerkzeug, siehe Preisliste · Stock tool, see price list
○ = Kurzfristig lieferbar, Preis auf Anfrage · Available on short notice, price upon inquiry



Mit Längennachstellung
With length adjustment

EM-L DIN

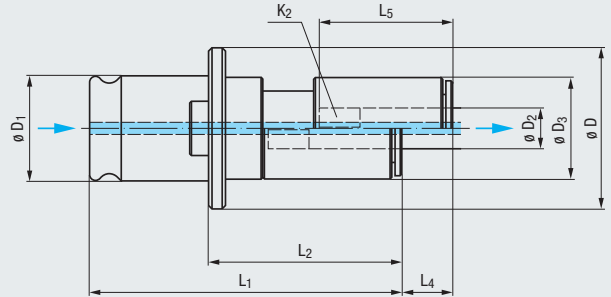
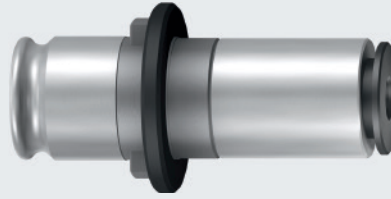

IKZ 1)

MMS
MQL

ρ_{max}
50bar
(700psi)

ρ_{max}
6bar
(85psi)

E-Lock

Typ · Type	EM 00-L/DIN	EM 01-L/DIN	EM 03-L/DIN	EM 04-L/DIN	EM 05-L/DIN
------------	-------------	-------------	-------------	-------------	-------------



	M1 - M10	M3 - M14	M4,5 - M24	M14 - M36	M22 - M48
$\varnothing D$	23	30	48	70	92
$\varnothing D_1$	13	19	31	48	60
$\varnothing D_3$	13	18	30	47	58
L_1	48	55	94	137	205
L_2	29	33	59	81	142
L_4	8	10	15	25	40

DIN

$\varnothing D_2$	K_2			Artikel-Nr. Article no.	L_5	Artikel-Nr. Article no.	L_5	Artikel-Nr. Article no.	L_5	Artikel-Nr. Article no.	L_5	Artikel-Nr. Article no.	L_5		
2,5	2,1	M1 - M1,8	M3,5	F0580100.6	21	●									
2,8	2,1	M2 - M2,6	M4	F0580101.6	21	●									
3,5	2,7	M3	M4,5 - M5	F0580102.6	22	●	F0581102.6	23	●						
4	3	M3,5	M5,5	F0580103.6	22	●	F0581103.6	22	●						
4,5	3,4	M4	M6	F0580104.6	22	●	F0581104.6	23	●						
6	4,9	M4,5 - M6	M8	F0580106.6	24	●	F0581106.6	25	●	F0583106.6	38	●			
7	5,5	M7	M9 - M10	F0580107.6	24	●	F0581107.6	25	●	F0583107.6	38	●			
8	6,2	M8	M11	2)		●	F0581108.6	26	●	F0583108.6	39	●			
9	7	M9	M12			●	F0581109.6	27	●	F0583109.6	40	●			
10	8	M10				●	F0581110.6	28	●	F0583110.6	41	●			
11	9		M14			●	F0581111.6	29	●	F0583111.6	42	●	F0584111.6	55	●
12	9		M16			2)	F0583112.6	42	●	F0584112.6	55	●			
14	11		M18				F0583113.6	44	●	F0584113.6	57	●			
16	12		M20				F0583114.6	45	●	F0584114.6	58	●			
18	14,5		M22 - M24				F0583115.6	47	●	F0584115.6	60	●	F0585115.6	94	●
20	16		M27				2)			F0584116.6	62	●	F0585116.6	96	●
22	18		M30				2)			F0584117.6	64	●	F0585117.6	98	●
25	20		M33							F0584118.6	66	●	F0585118.6	100	●
28	22		M36							F0584119.6	68	●	F0585119.6	102	●
32	24		M39 - M42							2)			F0585120.6	104	●
36	29		M45 - M48							2)			F0585121.6	109	●
40	32		M52 - M56										2)		
45	35		M60										2)		

1) Bei Verwendung von Gewindebohrern / Gewindeformern mit innerer Kühlschmierstoff-Zufuhr
If used with taps / cold-forming taps with internal coolant supply

2) Schnellwechsel-Einsätze mit erweitertem Spannbereich Typ EM-L-E siehe Seite 770
Quick-change adapters with extended clamping range type EM-L-E, see page 770

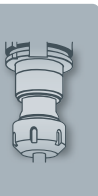

Mit Längennachstellung
With length adjustment

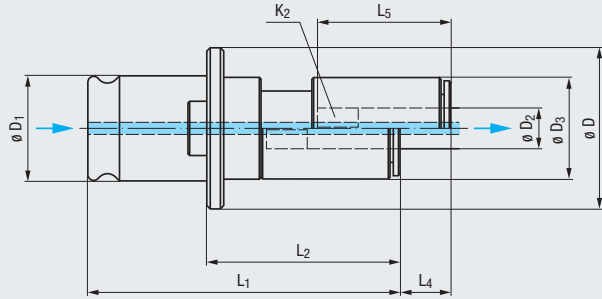
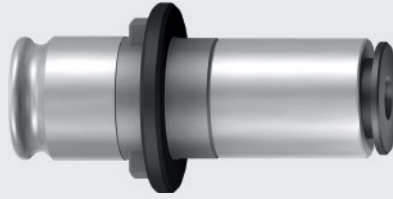

EM-L
ISO

p_{max}
50bar
(700psi)

p_{max}
6bar
(85psi)

Typ · Type	EM 00-L/ISO	EM 01-L/ISO	EM 03-L/ISO	EM 04-L/ISO	EM 05-L/ISO
	M1 - M9	M3,5 - M14	M6 - M24	M14 - M42	M24 - M48
$\varnothing D$	23	30	48	70	92
$\varnothing D_1$	13	19	31	48	60
$\varnothing D_3$	13	18	30	47	58
L ₁	48	55	94	137	205
L ₂	29	33	59	81	142
L ₄	8	10	15	25	40

DIN				Artikel-Nr. Article no.	L ₅	•	○	Artikel-Nr. Article no.	L ₅	•	○	Artikel-Nr. Article no.	L ₅	•	○	Artikel-Nr. Article no.	L ₅	•	○	Artikel-Nr. Article no.	L ₅	•	○	
2,24	1,8		M3	F0580200.6	20	●																		
2,5	2	M1 - M2	M3,5	F0580201.6	20	●																		
2,8	2,24	M2,2 - M2,6		F0580202.6	21	●																		
3,15	2,5	M3	M4	F0580203.6	21	●																		
3,55	2,8	M3,5	M4,5	F0580204.6	21	●	F0581204.6	22	●															
4	3,15	M4	M5	F0580205.6	22	●	F0581205.6	23	●															
4,5	3,55	M4,5	M6	F0580206.6	22	●	F0581206.6	23	●															
5	4	M5		F0580207.6	23	●	F0581207.6	24	●															
5,6	4,5		M7	F0580208.6	23	●	F0581208.6	24	●															
6,3	5	M6	M8	F0580209.6	24	●	F0581209.6	25	●	F0583209.6	38	●												
7,1	5,6	M7	M9	F0580210.6	24	●	F0581210.6	25	●	F0583210.6	38	●												
8	6,3	M8	M10 - M11	2)			F0581211.6	26	●	F0583211.6	39	●												
9	7,1	M9	M12				F0581212.6	27	●	F0583212.6	40	●												
10	8	M10					F0581110.6	28	●	F0583110.6	41	●												
11,2	9		M14				F0581214.6	29	●	F0583214.6	42	●	F0584214.6	55	●									
12,5	10		M16				2)			F0583215.6	43	●	F0584215.6	56	●									
14	11,2		M18 - M20							F0583216.6	44	●	F0584216.6	57	●									
16	12,5		M22							F0583217.6	46	●	F0584217.6	59	●									
18	14		M24							F0583218.6	48	●	F0584218.6	61	●	F0585218.6	95	●						
20	16		M27 - M30				2)			F0584116.6	63	●	F0585116.6	97	●									
22,4	18		M33				2)			F0584220.6	65	●	F0585220.6	99	●									
25	20		M36							F0584118.6	67	●	F0585118.6	101	●									
28	22,4		M39 - M42							F0584222.6	69	●	F0585222.6	103	●									
31,5	25		M45 - M48							2)			F0585223.6	105	●									
35,5	28		M52 - M56							2)			2)											
40	31,5		M60 - M64										2)											
45	35,5		M68										2)											

1) Bei Verwendung von Gewindebohrern / Gewindeformern mit innerer Kühlschmierstoff-Zufuhr
If used with taps / cold-forming taps with internal coolant supply

2) Schnellwechsel-Einsätze mit erweitertem Spannungsbereich Typ EM-L-E siehe Seite 770
Quick-change adapters with extended clamping range type EM-L-E, see page 770

Product Finder

- Soft-synchro
- Speed-synchro
- KSN
- MQL MMS
- SFM
- SWITCH-MASTER
- GR, GR-S
- HF
- EM
- Zubehör Accessories

Tech. Info

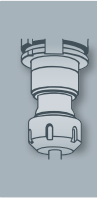

EM-L-E

DIN
ISO

Zum Schneiden von Feingewinden **MF**
For the cutting of fine threads

Mit Längennachstellung
With length adjustment

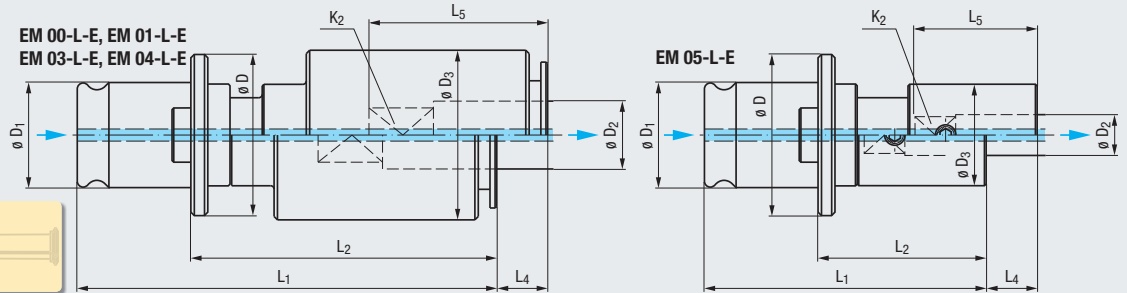
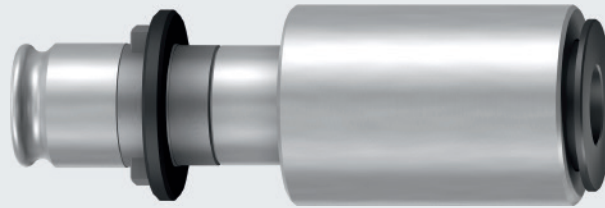

IKZ 1)

MMS MQL

p_{max} 50bar (700psi)

p_{max} 6bar (85psi)

Typ · Type	EM 00-L-E	EM 01-L-E	EM 03-L-E	EM 04-L-E	EM 05-L-E
$\varnothing D$	23	30	48	70	92
$\varnothing D_1$	13	19	31	48	60
$\varnothing D_3$	18	30	50	60	58
L_1	73	89	147	191	190
L_2	54	67	112	135	127
L_4	8	10	15	25	40

Typ · Type		EM 00-L-E/DIN		EM 01-L-E/DIN		EM 03-L-E/DIN		EM 04-L-E/DIN		EM 05-L-E/DIN	
Feingewinde Fine thread MF		M8 - M11		M16		M27 - M30		M39 - M48		M52 - M60	
$\varnothing D_2$	K_2			Artikel-Nr. Article no.	L_5	Artikel-Nr. Article no.	L_5	Artikel-Nr. Article no.	L_5	Artikel-Nr. Article no.	L_5
8	6,2	M8	M11	F0820108.6	26	●					
12	9		M16			F0821112.6	41	●			
20	16		M27					F0823116.6	64	●	
22	18		M30					F0823117.6	66	●	
32	24		M39 - M42					F0824120.6	102	●	
36	29		M45 - M48					F0824121.6	107	●	
40	32		M52 - M56							F0825122.6	83
45	35		M60							F0825123.6	83

Typ · Type		EM 00-L-E/ISO		EM 01-L-E/ISO		EM 03-L-E/ISO		EM 04-L-E/ISO		EM 05-L-E/ISO		
Feingewinde Fine thread MF		M8 - M11		M16		M27 - M33		M45 - M56		M52 - M68		
$\varnothing D_2$	K_2			Artikel-Nr. Article no.	L_5	Artikel-Nr. Article no.	L_5	Artikel-Nr. Article no.	L_5	Artikel-Nr. Article no.	L_5	
8	6,3	M8	M10 - M11	F0820211.6	26	●						
12,5	10		M16			F0821215.6	42	●				
20	16		M27 - M30					F0823116.6	65	●		
22,4	18		M33					F0823220.6	67	●		
31,5	25		M45 - M48					F0824223.6	103	●		
35,5	28		M52 - M56					F0824224.6	106	●	F0825224.6	76
40	31,5		M60 - M64							F0825225.6	79	
45	35,5		M68							F0825226.6	83	

1) Bei Verwendung von Gewindebohrern mit innerer Kühlschmierstoff-Zufuhr
If used with taps with internal coolant supply

Mit Längennachstellung, mit Überlastkupplung
 With length adjustment, with overload clutch

EM-UL
 DIN

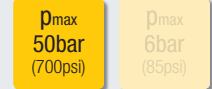
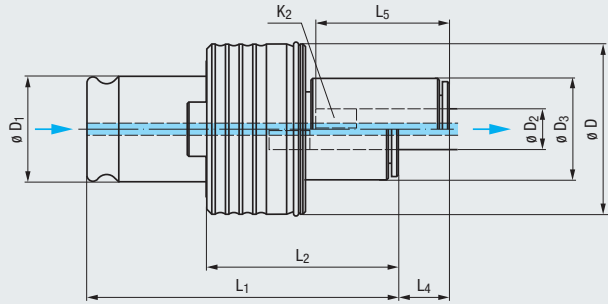
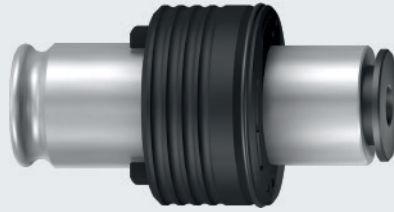

- Product Finder
- Soft-synchro
- Speed-synchro
- KSN
- MQL MMS
- SFM
- SWITCH-MASTER
- GR, GR-S
- HF
- EM
- Zubehör Accessories

Typ · Type	EM 00-UL/DIN	EM 01-UL/DIN	EM 03-UL/DIN	EM 04-UL/DIN	EM 05-UL/DIN
	M1 - M10	M3 - M14	M4,5 - M24	M14 - M36	M22 - M48
∅ D	24	33	50	72	95
∅ D ₁	13	19	31	48	60
∅ D ₃	13	18	30	47	58
L ₁	49	55	94	137	205
L ₂	29	33	59	81	142
L ₄	8	10	15	25	40

DIN		∅ D ₂		K ₂		Artikel-Nr. Article no.		L ₅		Artikel-Nr. Article no.		L ₅		Artikel-Nr. Article no.		L ₅		Artikel-Nr. Article no.		L ₅	
2,5	2,1	M1 - M1,8				F0590100.1.6	21	●													
2,5	2,1		M3,5			F0590100.2.6	21	●													
2,8	2,1	M2				F0590101.1.6	21	●													
2,8	2,1	M2,5				F0590101.2.6	21	●													
2,8	2,1		M4			F0590101.3.6	21	●													
3,5	2,7	M3				F0590102.1.6	22	●	F0591102.1.6	23	●										
3,5	2,7		M4,5 - M5			F0590102.2.6	22	●	F0591102.2.6	23	●										
4	3	M3,5				F0590103.6	22	●	F0591103.6	22	●										
4,5	3,4	M4				F0590104.1.6	22	●	F0591104.1.6	23	●										
4,5	3,4		M6			F0590104.2.6	22	●	F0591104.2.6	23	●										
6	4,9	M4,5 - M5				F0590106.1.6	24	●	F0591106.1.6	25	●	F0593106.1.6	38	●							
6	4,9	M6				F0590106.2.6	24	●	F0591106.2.6	25	●	F0593106.2.6	38	●							
6	4,9		M8			F0590106.3.6	24	●	F0591106.3.6	25	●	F0593106.3.6	38	●							
7	5,5		M10			F0590107.6	24	●	F0591107.6	25	●	F0593107.6	38	●							
8	6,2	M8				2)			F0591108.6	26	●	F0593108.6	39	●							
9	7		M12						F0591109.6	27	●	F0593109.6	40	●							
10	8	M10							F0591110.6	28	●	F0593110.6	41	●							
11	9		M14						F0591111.6	29	●	F0593111.6	42	●	F0594111.6	55	●				
12	9		M16						2)			F0593112.6	42	●	F0594112.6	55	●				
14	11		M18									F0593113.6	44	●	F0594113.6	57	●				
16	12		M20									F0593114.6	45	●	F0594114.6	58	●				
18	14,5		M22 - M24									F0593115.6	47	●	F0594115.6	60	●	F0595115.6	94	●	
20	16		M27									2)			F0594116.6	62	●	F0595116.6	96	●	
22	18		M30									2)			F0594117.6	64	●	F0595117.6	98	●	
25	20		M33												F0594118.6	66	●	F0595118.6	100	●	
28	22		M36												F0594119.6	68	●	F0595119.6	102	●	
32	24		M39 - M42												2)			F0595120.6	104	●	
36	29		M45 - M48												2)			F0595121.6	109	●	
40	32		M60 - M64															2)			
45	35		M68															2)			

2) Schnellwechsel-Einsätze mit erweitertem Spannbereich Typ EM-UL-E siehe Seite 773
 Quick-change adapters with extended clamping range type EM-UL-E, see page 773



EM-UL

ISO

Mit Längennachstellung, mit Überlastkupplung
With length adjustment, with overload clutch

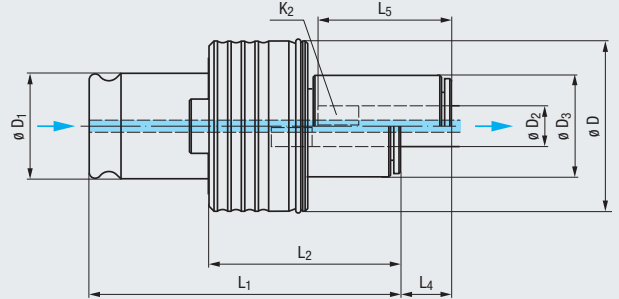
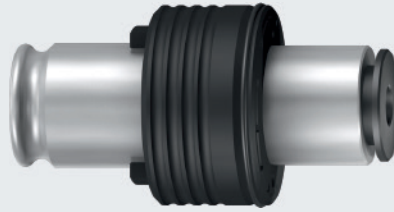

IKZ 1)

MMS
MQL

p_{max}
50bar
(700psi)

p_{max}
6bar
(85psi)

E-Lock

Typ · Type	EM 00-UL/ISO	EM 01-UL/ISO	EM 03-UL/ISO	EM 04-UL/ISO	EM 05-UL/ISO
	M1 - M9	M3,5 - M14	M6 - M24	M14 - M42	M24 - M48
$\varnothing D$	24	33	50	72	95
$\varnothing D_1$	13	19	31	48	60
$\varnothing D_3$	13	18	30	47	58
L_1	49	55	94	137	205
L_2	29	33	59	81	142
L_4	8	10	15	25	40

DIN				Artikel-Nr. Article no.	L_5	Artikel-Nr. Article no.	L_5	Artikel-Nr. Article no.	L_5	Artikel-Nr. Article no.	L_5	Artikel-Nr. Article no.	L_5		
$\varnothing D_2$	K_2														
2,24	1,8		M3	F0590200.6	20	●									
2,5	2	M1 - M2		F0590201.1.6	20	●									
2,5	2		M3,5	F0590201.2.6	20	●									
2,8	2,24	M2,2 - M2,6		F0590202.6	21	●									
3,15	2,5	M3		F0590203.1.6	21	●									
3,15	2,5		M4	F0590203.2.6	21	●									
3,55	2,8	M3,5		F0590204.1.6	21	●	F0591204.1.6	22	●						
3,55	2,8		M4,5	F0590204.2.6	21	●	F0591204.2.6	22	●						
4	3,15	M4		F0590205.1.6	22	●	F0591205.1.6	23	●						
4	3,15		M5	F0590205.2.6	22	●	F0591205.2.6	23	●						
4,5	3,55	M4,5		F0590206.1.6	22	●	F0591206.1.6	23	●						
4,5	3,55		M6	F0590206.2.6	22	●	F0591206.2.6	23	●						
5	4	M5		F0590207.6	23	●	F0591207.6	24	●						
5,6	4,5		M7	F0590208.6	23	●	F0591208.6	24	●						
6,3	5	M6		F0590209.1.6	24	●	F0591209.1.6	25	●	F0593209.1.6	38	●			
6,3	5		M8	F0590209.2.6	24	●	F0591209.2.6	25	●	F0593209.2.6	38	●			
7,1	5,6	M7	M9	F0590210.6	24	●	F0591210.6	25	●	F0593210.6	38	●			
8	6,3	M8	M10 - M11	2)			F0591211.6	26	●	F0593211.6	39	●			
9	7,1	M9	M12				F0591212.6	27	●	F0593212.6	40	●			
10	8	M10					F0591110.6	28	●	F0593110.6	41	●			
11,2	9		M14				F0591214.6	29	●	F0593214.6	42	●	F0594214.6	55	●
12,5	10		M16				2)			F0593215.6	43	●	F0594215.6	56	●
14	11,2		M18 - M20							F0593216.6	44	●	F0594216.6	57	●
16	12,5		M22							F0593217.6	46	●	F0594217.6	59	●
18	14		M24							F0593218.6	48	●	F0594218.6	61	●
20	16		M27 - M30				2)			F0594116.6	63	●	F0595218.6	95	●
22,4	18		M33				2)			F0594220.6	65	●	F0595116.6	97	●
25	20		M36							F0594118.6	67	●	F0595220.6	99	●
28	22,4		M39 - M42							F0594222.6	69	●	F0595118.6	101	●
31,5	25		M45 - M48							2)			F0595222.6	103	●
35,5	28		M52 - M56							2)			F0595223.6	105	●
40	31,5		M60 - M64							2)			2)		
45	35,5		M68							2)			2)		

2) Schnellwechsel-Einsätze mit erweitertem Spannbereich Typ EM-UL-E siehe Seite 773
Quick-change adapters with extended clamping range type EM-UL-E, see page 773

MF Zum Schneiden von Feingewinden
For the cutting of fine threads

Mit Längennachstellung, mit Überlastkupplung
With length adjustment, with overload clutch



EM-UL-E

DIN
ISO

IKZ 1)

MMS MQL

p_{max} 50bar (700psi)

p_{max} 6bar (85psi)

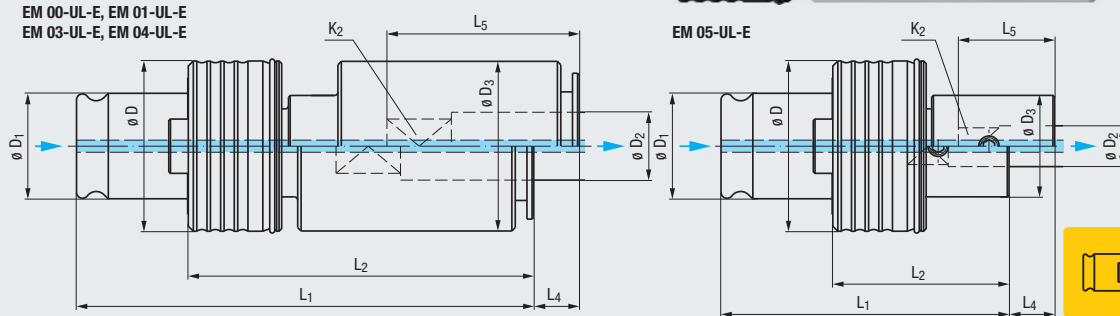

Typ · Type	EM 00-UL-E	EM 01-UL-E	EM 03-UL-E	EM 04-UL-E	EM 05-UL-E
ϕD	24	33	50	72	95
ϕD_1	13	19	31	48	60
ϕD_3	18	30	50	60	58
L_1	73	89	147	191	190
L_2	53,5	67	112	135	127
L_4	8	10	15	25	40

Typ · Type	EM 00-UL-E/DIN	EM 01-UL-E/DIN	EM 03-UL-E/DIN	EM 04-UL-E/DIN	EM 05-UL-E/DIN
Feingewinde Fine thread MF	M8 - M11	M16	M27 - M30	M39 - M48	M52 - M60

DIN				Artikel-Nr. Article no.		L_5	●	Artikel-Nr. Article no.		L_5	●	Artikel-Nr. Article no.		L_5	●	Artikel-Nr. Article no.		L_5	●		
ϕD_2	K_2																				
8	6,2	M8	M11	F0830108.6	26	●	F0831112.6	41	●												
12	9		M16																		
20	16		M27																		
22	18		M30																		
32	24		M39 - M42										F0834120.6	102	●						
36	29		M45 - M48										F0834121.6	107	●						
40	32		M52 - M56																F0835122.6	83	●
45	35		M60																F0835123.6	83	●

Typ · Type	EM 00-UL-E/ISO	EM 01-UL-E/ISO	EM 03-UL-E/ISO	EM 04-UL-E/ISO	EM 05-UL-E/ISO
Feingewinde Fine thread MF	M8 - M11	M16	M27 - M33	M45 - M56	M52 - M68

ISO				Artikel-Nr. Article no.		L_5	●	Artikel-Nr. Article no.		L_5	●	Artikel-Nr. Article no.		L_5	●	Artikel-Nr. Article no.		L_5	●		
ϕD_2	K_2																				
8	6,3	M8	M10 - M11	F0830211.6	26	●	F0831215.6	42	●												
12,5	10		M16																		
20	16		M27 - M30																		
22,4	18		M33																		
31,5	25		M45 - M48										F0834223.6	103	●						
35,5	28		M52 - M56										F0834224.6	106	●				F0835224.6	76	●
40	31,5		M60 - M64																F0835225.6	79	●
45	35,5		M68																F0835226.6	83	●

1) Bei Verwendung von Gewindebohrern / Gewindefornern mit innerer Kühlschmierstoff-Zufuhr
If used with taps / cold-forming taps with internal coolant supply

Product Finder

Soft-synchro

Speed-synchro

KSN

MQL MMS

SFM

SWITCH-MASTER

GR, GR-S

HF

EM

Zubehör
Accessories

Tech. Info

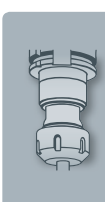

- Product Finder
- Soft-synchro
- Speed-synchro
- KSN
- MQL MMS
- SFM
- SWITCH-MASTER
- GR, GR-S
- HF
- EM
- Zubehör Accessories
- Tech. Info

EM-Z/ER/IKZ

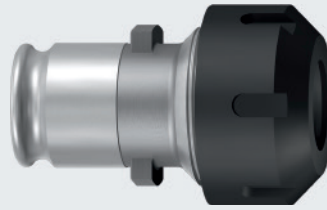

IKZ 1)

MMS MQL

ρ_{max}
50bar
(700psi)

ρ_{max}
6bar
(85psi)

E-Lock

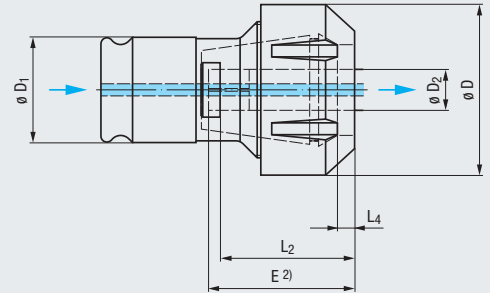

Typ Type		$\varnothing D_2$			$\varnothing D$	$\varnothing D_1$	L_2	L_4	Artikel-Nr. Article no.	
EM 00-Z/ER/IKZ	M2 - M8 (Nr.2 - 5/16)	2,5 - 7	ER 11 (GB)	Hi-Q/ER 11	19	13	23	0,9	F0860001	●
EM 01-Z/ER/IKZ	M4 - M12 (Nr.8 - 7/16)	4,5 - 10	ER 20 (GB)	Hi-Q/ERC 20	34	19	34,5	5	F0861001.13	●
EM 03-Z/ER/IKZ	M4 - M20 (Nr.8 - 3/4)	4,5 - 16	ER 32 (GB)	Hi-Q/ERC 32	50	31	41,5	5	F0863001.13	●

1) Bei Verwendung von Gewindebohrern / Gewindeformern mit innerer Kühlschmierstoff-Zufuhr
If used with taps / cold-forming taps with internal coolant supply

2) Einstecktiefen E siehe Seite 797
Clamping depths E, see page 797

EM00-Z/ER/IKZ:

Spannmutter ohne integrierte Abdichtung ist im Lieferumfang enthalten
Clamping nut without integrated seal is included in the delivery

EM01-Z/ER/IKZ, EM03-Z/ER/IKZ:

Spannmutter für Dichtscheiben ist im Lieferumfang enthalten
Clamping nut for sealing disks is included in the delivery

Zubehör Accessories

- Spannzangen Typ ER (GB)
Collets type ER (GB)
▶▶ 786 - 787
- Dichtscheiben Typ DS/ER
Sealing disks type DS/ER
▶▶ 789
- Spannmutter mit integrierter Abdichtung Typ Hi-Q/ERC 11
Clamping nut with integrated seal, type Hi-Q/ERC 11
▶▶ 791
- Spannschlüssel
Clamping wrench
▶▶ 794

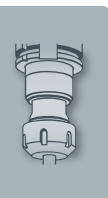

Mit Längennachstellung
With length adjustment

EM-L/ER/IKZ

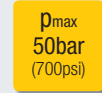
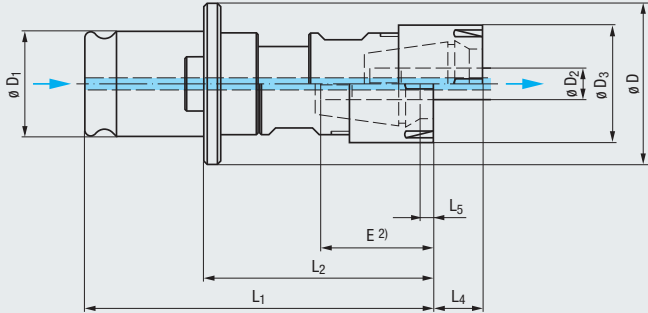
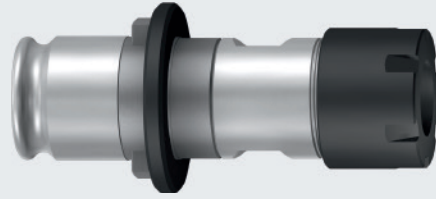

Product Finder

Soft-synchro

Speed-synchro

KSN

MQL MMS

SFM

SWITCH-MASTER

GR, GR-S

HF

EM

Zubehör Accessories

Tech. Info

Typ Type		$\varnothing D_2$			$\varnothing D$	$\varnothing D_1$	$\varnothing D_3$	L_1	L_2	L_4	L_5	Artikel-Nr. Article no.	
EM 00-L/ER/IKZ	M2 - M8 (Nr.2 - 5/16)	2,5 - 7	ER 11 (GB)	Hi-Q/ERM 11	23	13	16	57,5	38	8	0,9	F3500011	●
EM 01-L/ER/IKZ	M4 - M12 (Nr.8 - 7/16)	4,5 - 9	ER 16 (GB)	Hi-Q/ERMC 16	30	19	22	72	50,5	10	5	F3501016	●
EM 03-L/ER/IKZ	M4 - M20 (Nr.8 - 3/4)	4,5 - 16	ER 25 (GB)	Hi-Q/ERMC 25	48	31	35	103	68	15	5	F3503025	●

1) Bei Verwendung von Gewindebohrern / Gewindeformern mit innerer Kühlschmierstoff-Zufuhr
If used with taps / cold-forming taps with internal coolant supply

2) Einstecktiefen E siehe Seite 797
Clamping depths E, see page 797

EM00-L/ER/IKZ:

Spannmutter ohne integrierte Abdichtung ist im Lieferumfang enthalten
Clamping nut without integrated seal is included in the delivery

EM01-L/ER/IKZ, EM03-L/ER/IKZ:

Spannmutter für Dichtscheiben ist im Lieferumfang enthalten
Clamping nut for sealing disks is included in the delivery

Zubehör

Accessories



Spannzangen Typ ER (GB)
Collets type ER (GB)

» 786 - 787



Dichtscheiben Typ DS/ER
Sealing disks type DS/ER

» 789



Spannmutter mit integrierter Abdichtung Typ Hi-Q/ERMC 11
Clamping nut with integrated seal, type Hi-Q/ERMC 11

» 790



Spannschlüsselsatz
Set of clamping wrenches

» 794



- Product Finder
- Soft-synchro
- Speed-synchro
- KSN
- MQL MMS
- SFM
- SWITCH-MASTER
- GR, GR-S
- HF
- EM**
- Zubehör Accessories
- Tech. Info

EM/PGR/IKZ

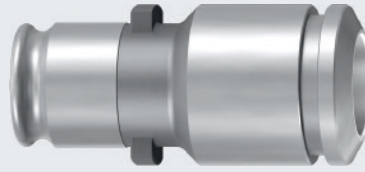

IKZ 1)

MMS MQL

ρ_{max}
50bar
(700psi)

ρ_{max}
6bar
(85psi)

E-Lock

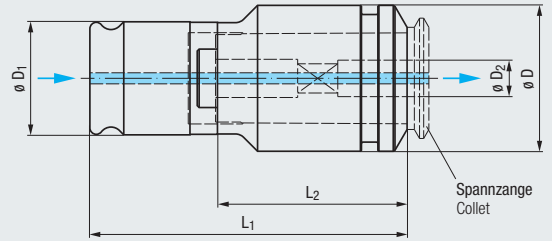

Typ Type		ø D ₂		ø D	ø D ₁	L ₁	L ₂	Artikel-Nr. Article no.	
EM 01/PGR/IKZ	M4 - M12 (Nr.8 - 7/16)	4,5 - 10	PGR 15 (GB)	24	19	64	42	F3561015	●
EM 03/PGR/IKZ	M8 - M20 (5/16 - 3/4)	8 - 16	PGR 25 (GB)	40	31	87	52	F3563025	●

1) Bei Verwendung von Gewindebohrern / Gewindeformern mit innerer Kühlschmierstoff-Zufuhr
If used with taps / cold-forming taps with internal coolant supply

Zubehör Accessories



Spannzangen Typ PGR-GB
Collets type PGR-GB ▶▶ 796

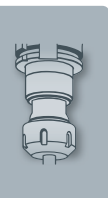

EM-SE

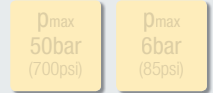
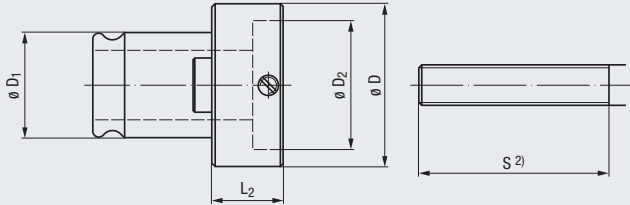
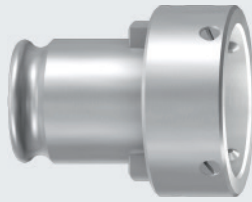

Product Finder

Soft-synchro

Speed-synchro

KSN

MQL MMS

SFM

SWITCH-MASTER

GR, GR-S

HF

EM

Zubehör Accessories

Tech. Info

Typ Type			$\varnothing D$	$\varnothing D_1$	S ²⁾	$\varnothing D_2$	L ₂	Artikel-Nr. Article no.	
	$\varnothing d_2 \times h_1$								
EM 01-SE	16 x 5	M1 - M4	30	19	36	16	15	F0621600	●
	20 x 5	M3 - M4	30	19	36	20	15	F0621601	●
	20 x 7	M4,5 - M6	30	19	38	20	17	F0621602	●
	25 x 9	M7 - M9	35	19	40	25	19	F0621603	●
	30 x 11	M10 - M11	40	19	42	30	20,5	F0621604	●
	38 x 10	M12x1 - M15x1,5	48	19	41 (M12); 10 (M14-M15)	38	19,5	F0621605	●
	38 x 14	M12 - M14	48	19	45 (M12); 14 (M14)	38	23,5	F0621606	●
EM 03-SE	20 x 5	M3 - M4	40	31	55	20	20	F0623601	●
	20 x 7	M4,5 - M6	40	31	56	20	21,5	F0623602	●
	25 x 9	M7 - M9	40	31	58	25	23,5	F0623603	●
	30 x 11	M10 - M11	40	31	60	30	25	F0623604	●
	38 x 10	M12x1 - M15x1,5	48	31	56	38	21	F0623605	●
	38 x 14	M12 - M14	48	31	60	38	25	F0623606	●
	45 x 14	M16x1 - M20x2	57	31	60	45	25	F0623607	●
	45 x 18	M16 - M20	57	31	64	45	29	F0623608	●
EM 04-SE	30 x 11	M10 - M11	60	48	84	30	29	F0624604	●
	38 x 10	M12x1 - M15x1,5	60	48	83	38	28	F0624605	●
	38 x 14	M12 - M14	60	48	87	38	32	F0624606	●
	45 x 14	M16x1 - M20x2	60	48	87	45	32	F0624607	●
	45 x 18	M16 - M20	60	48	91	45	36	F0624608	●
	55 x 16	M22x1 - M26x1,5	72	48	85	55	30	F0624609	●
	55 x 22	M22 - M24	72	48	90	55	35	F0624610	●
	65 x 18	M27x1 - M36x2	82	48	87	65	32	F0624611	●
	65 x 25	M27 - M36	82	48	93	65	38	F0624612	●

²⁾ Max. zu schneidende Gewindelänge
Max. thread length to be cut

Weitere Größen auf Anfrage
Further sizes upon request



- Product Finder
- Soft-synchro
- Speed-synchro
- KSN
- MQL MMS
- SFM
- SWITCH-MASTER
- GR, GR-S
- HF
- EM
- Zubehör Accessories
- Tech. Info

EM-R

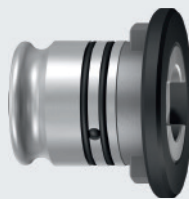

p_{max} 50bar (700psi)	p_{max} 6bar (85psi)	

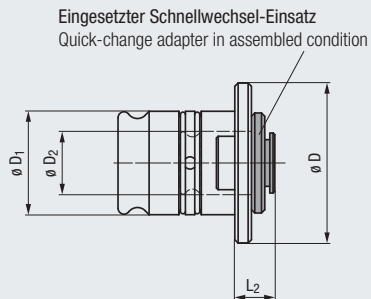

Typ Type		$\varnothing D$	$\varnothing D_1$	$\varnothing D_2$	L_2	Artikel-Nr. Article no.	
EM 01/00-R	EM 00	30	19	13	11	F0891000	●
EM 03/00-R	EM 00	48	31	13	12	F0893000	●
EM 03/01-R	EM 01	48	31	19	12	F0893001	●
EM 04/01-R	EM 01	70	48	19	13	F0894001	●
EM 04/03-R	EM 03	70	48	31	17	F0894003	●
EM 05/03-R	EM 03	92	60	31	24	F0895003	●
EM 05/04-R	EM 04	92	60	48	27	F0895004	●

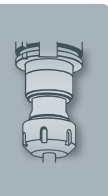

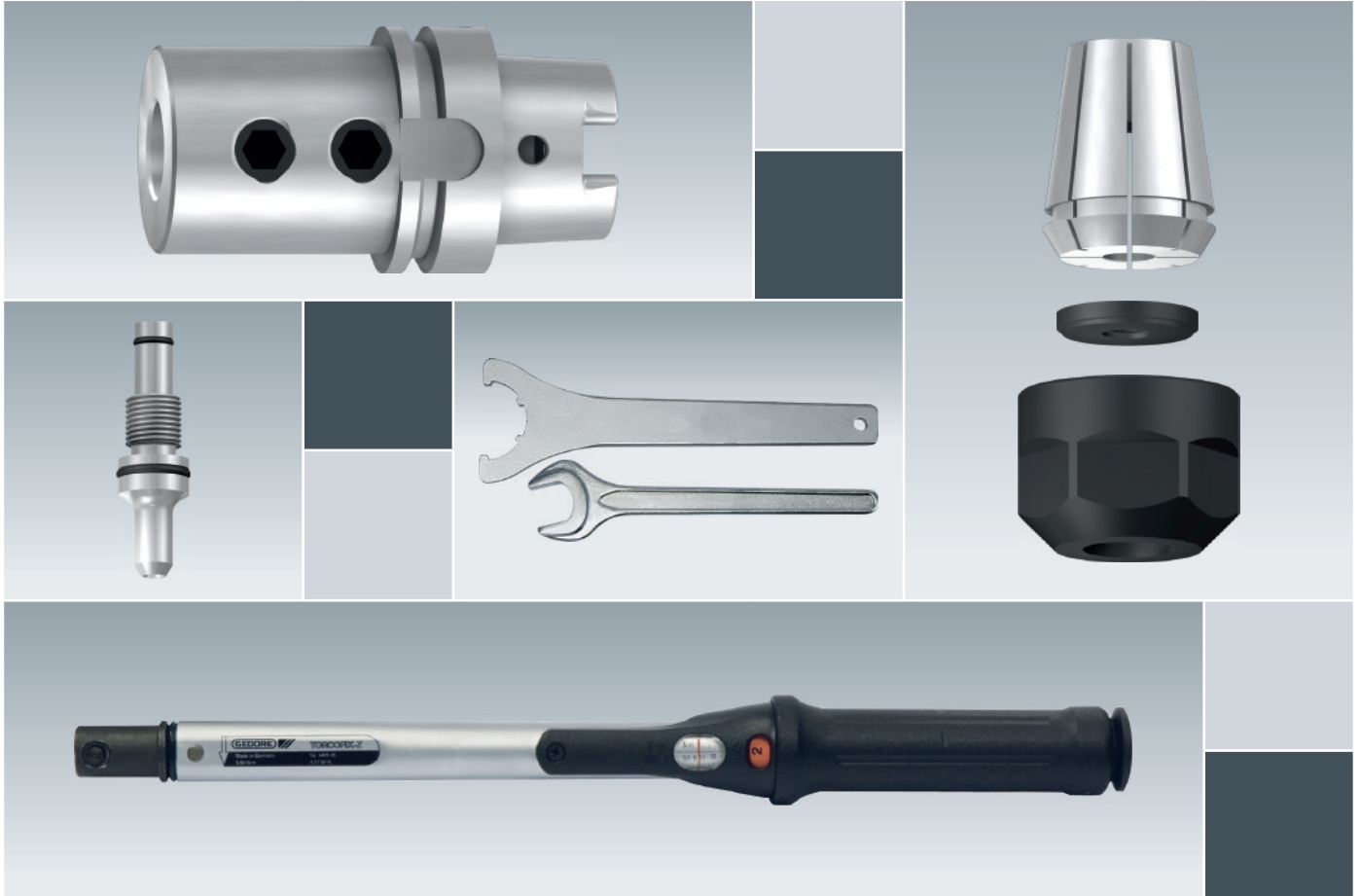

Zubehör für Aufnahmen und Gewindeschneidapparate Accessories for Tap Holders and Tapping Attachments



- Product Finder
- Soft-synchro
- Speed-synchro
- KSN
- MQL MMS
- SFM
- SWITCH-MASTER
- GR, GR-S
- HF
- EM
- Zubehör Accessories
- Tech. Info

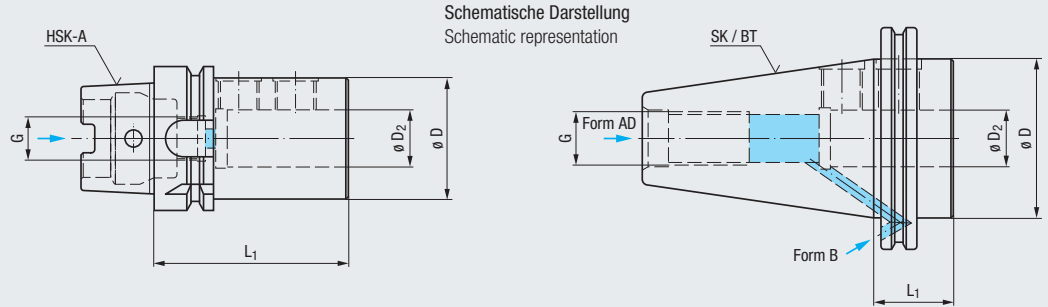
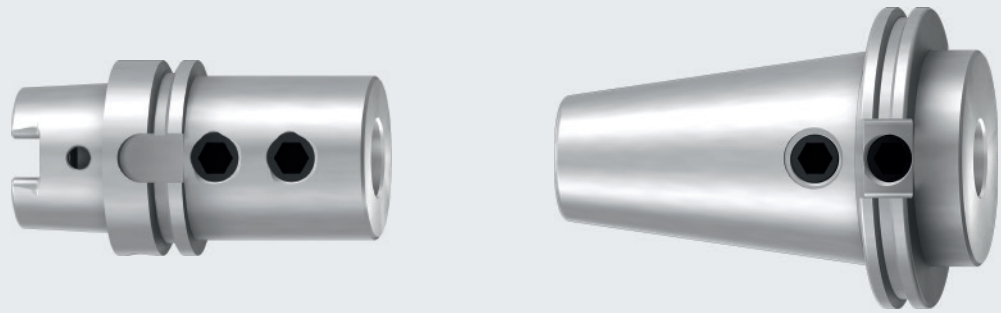

Typ Type	Form Form	Schaftgröße Shank size	$\varnothing D_2$	$\varnothing D$	G	L ₁	Artikel-Nr. Article no.	
DIN 69893 A 1) 2)		HSK-A40	20	52	M12 x 1	75	F33000C.02	●
		HSK-A40	25	65	M12 x 1	105	F33000C.03	●
		HSK-A50	20	52	M16 x 1	80	F33000C.04	●
		HSK-A50	25	65	M16 x 1	107	F33000C.05	●
		HSK-A50	32	77	M16 x 1	114	F33000C.06	●
		HSK-A63	25	53	M18 x 1	85	F33000C.07	●
		HSK-A63	32	72	M18 x 1	110	F33000C.08	●
		HSK-A80	25	65	M20 x 1,5	90	F33000C.09	●
		HSK-A80	32	72	M20 x 1,5	110	F33000C.10	●
DIN 69871 AD 1)	AD	SK 40	25	45	M16	35	F330006.01	●
		SK 50	25	70	M24	35	F330006.02	●
		SK 50	32	70	M24	35	F330006.05	●
DIN 69871 B 1)	B	SK 40	25	45	M16	35	F330006.03	●
		SK 50	25	70	M24	35	F330006.04	●
		SK 50	32	70	M24	35	F330006.06	●
DIN 2080	AD	SK 30	20	36	M12	34	F330005.03	●
		SK 40	25	44	M16	22	F330005.01	●
		SK 50	25	70	M24	16	F330005.02	●
		SK 50	32	70	M24	16	F330005.04	●
ASME B5.50 Metr.	AD	SK 40	25	45	M16	35	F330007.01	○
		SK 50	25	70	M24	35	F330007.02	○
		SK 50	32	70	M24	35	F330007.06	○
ASME B5.50 UNC	AD	SK 40	25	44,5	5/8 - 11	35	F330007.03	○
		SK 50	25	70	1" - 8	35	F330007.04	○
		SK 50	32	70	1" - 8	35	F330007.05	○
JIS B 6339 (MAS 403 BT)	AD	BT 30	20	36	M12	35	F330008.04	●
		BT 40	25	45	M16	35	F330008.01	●
		BT 50	25	70	M24	44	F330008.02	●
		BT 50	32	70	M24	44	F330008.03	●

1) Mit Bohrung für Datenträger DIN 69873
With bore for data chip according to DIN 69873

Weitere Ausführungen auf Anfrage
Further designs upon request

2) Kühlschmierstoffrohre und Schlüssel siehe Seite 782 - 783, bitte extra bestellen
Coolant tubes and wrenches see page 782 - 783, please order separately

Spannschraube ist im Lieferumfang enthalten
The locking screw is included in the delivery

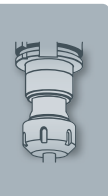

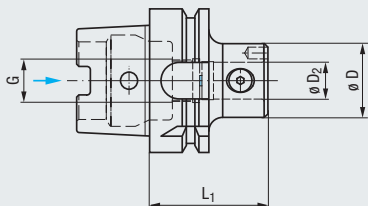
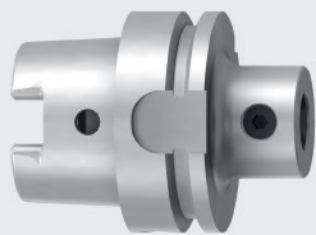

Product Finder

Soft-synchro

Speed-synchro

KSN

MQL MMS

SFM

SWITCH-MASTER

GR, GR-S

HF

EM

Zubehör Accessories

Tech. Info

new

Typ Type	Schaftgröße Shank size	ø D ₂	ø D	G	L ₁	Artikel-Nr. Article no.	
DIN 69893 A 1)	HSK-A63	16	ABS 32	M18 x 1	50	F33000C.48	●
	HSK-A100	16	ABS 32	M24 x 1,5	60	F33000C.50	●

1) Mit Bohrung für Datenträger DIN 69873
With bore for data chip according to DIN 69873

Weitere Ausführungen auf Anfrage
Further designs upon request

Spannschraube ist im Lieferumfang enthalten
The locking screw is included in the delivery

Zubehör
Accessories



Kühlschmierstoffrohre, Füllstücke und Schlüssel
Coolant tubes, adapters and wrenches

» 782 - 783



- Product Finder
- Softsynchro
- Speedsynchro
- KSN
- MQL MMS
- SFM
- SWITCH-MASTER
- GR, GR-S
- HF
- EM
- Zubehör Accessories
- Tech. Info

Kühlschmierstoffrohre Coolant tubes

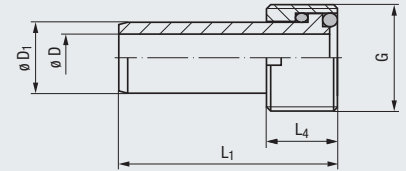

DIN 69895

Für Schaftgröße For shank size	$\varnothing D$	$\varnothing D_1$	L_4	L_1	G	Artikel-Nr. Article no.	
HSK-A40	5	8	8	29,5	M12 x 1	F330049.02	●
HSK-A50	6,4	10	10	33	M16 x 1	F330049.03	●
HSK-A63	8	12	12	36,5	M18 x 1	F330049.04	●
HSK-A80	10	14	14	40	M20 x 1,5	F330049.05	●
HSK-A100	12	16	16	44	M24 x 1,5	F330049.06	●

Kühlschmierstoffrohre Coolant tubes

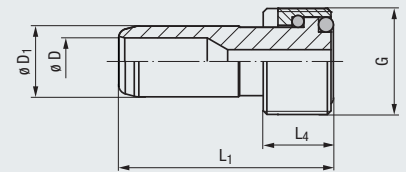

Geeignet für Softsynchro® Modular/MQL
und Speedsynchro® Modular/MQL

Suitable for Softsynchro® Modular/MQL
and Speedsynchro® Modular/MQL

DIN 69090-4

new							
Für Schaftgröße For shank size	$\varnothing D$	$\varnothing D_1$	L_4	L_1	G	Artikel-Nr. Article no.	
HSK-A40	5	8	8	29,5	M12 x 1	F355149.13	●
HSK-A63	8	12	12	36,5	M18 x 1	F355149.03	●
HSK-A100	12	16	16	44	M24 x 1,5	F355149.06	●

Kühlschmierstoffrohre Coolant tubes

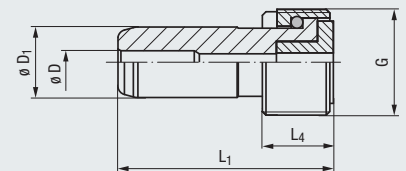

Geeignet für Softsynchro® Modular/MQL
und Speedsynchro® Modular/MQL

Suitable for Softsynchro® Modular/MQL
and Speedsynchro® Modular/MQL

DIN 69090-4

new								
Für Schaftgröße For shank size	Für Schaftgröße For shank size	$\varnothing D$	$\varnothing D_1$	L_4	L_1	G	Artikel-Nr. Article no.	
Softsynchro® 1 Modular/MQL Speedsynchro® Modular/MQL	HSK-A40	4	8	8	29,5	M12 x 1	F355149.11	●
	HSK-A63	4	12	12	36,5	M18 x 1	F355149.04	●
	HSK-A100	4	16	16	44	M24 x 1,5	F355149.08	●
Softsynchro® 3 Modular/MQL	HSK-A63	4	12	12	36,5	M18 x 1	F355349.02	●
	HSK-A100	4	16	16	44	M24 x 1,5	F355349.04	●

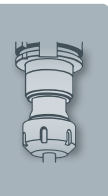

Füllstücke 1)
Adapters

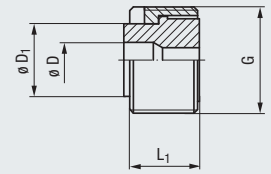

Geeignet für Softsynchro® Modular/MQL
und Speedsynchro® Modular/MQL

Suitable for Softsynchro® Modular/MQL
and Speedsynchro® Modular/MQL

DIN 69090-4

new					
Für Schaftgröße For shank size	$\varnothing D$	$\varnothing D_1$	L_1	G	Artikel-Nr. Article no.
HSK-A40	4	8,4	8,3	M12 x 1	F355335.01
HSK-A63	6	12,4	12,3	M18 x 1	F355135.01
HSK-A100	10	16,4	16,4	M24 x 1,5	F355135.02

1) Füllstücke werden für HSK-A-Schäfte verwendet, d.h. Außenkontur entspricht DIN 69893 A, Innenkontur nach DIN 69893 C
Adapters are used for HSK-A shanks, that means outside contour acc. DIN 69893 A, inside contour acc. DIN 69893 C

Montageschlüssel
Assembly wrenches

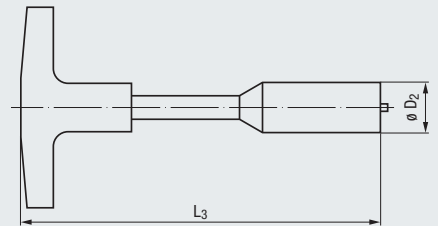
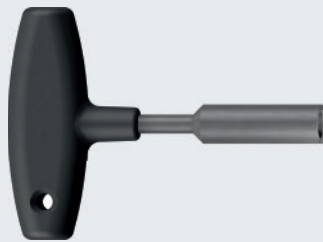

Für Schaftgröße For shank size	$\varnothing D_2$	L_3	Artikel-Nr. Article no.
HSK-A40	11	111	F330099.02
HSK-A50	15	120	F330099.03
HSK-A63	17	122	F330099.04
HSK-A80	18,5	126	F330099.05
HSK-A100	22	141	F330099.06

Montage des Kühlschmierstoffrohrs im HSK-Schaft

1. Montageschlüssel auf das Kühlschmierstoffrohr stecken.
Wichtig: Auf die Stellung der Zapfen zu den Nuten achten!

Assembly of the coolant tube in the hollow taper (HSK) shank

1. Put assembly wrench on the coolant tube.
Important: Watch the position of the pins against the grooves

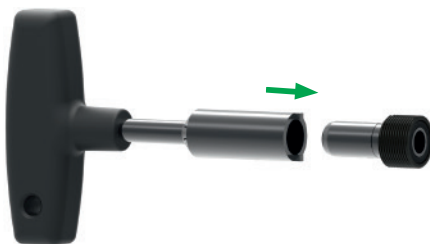

2. Kühlschmierstoffrohr in den Schaft einschrauben.

2. Screw coolant tube into the shank.

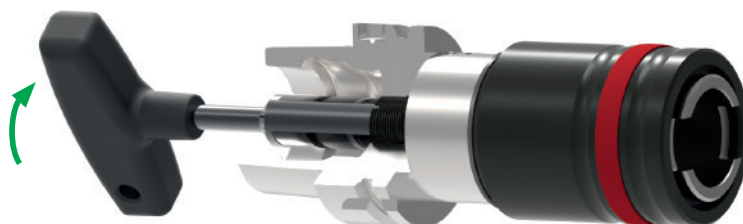

- Product Finder
- Softsynchro
- Speedsynchro
- KSN
- MQL MMS
- SFM
- SWITCH-MASTER
- GR, GR-S
- HF
- EM
- Zubehör Accessories
- Tech. Info

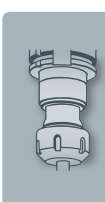

- Product Finder
- Softsynchro
- Speedsynchro
- KSN
- MQL MMS
- SFM
- SWITCH-MASTER
- GR, GR-S
- HF
- EM
- Zubehör Accessories
- Tech. Info

Von beiden Seiten justierbar, für Werkzeugschäfte mit Innenzentrierung 60°
 Adjustable from both sides, for tool shanks with female centre 60°

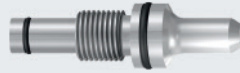

Geeignet für Softsynchro® Modular/IKZ und Softsynchro® Modular/MQL

Suitable for Softsynchro® Modular/IKZ and Softsynchro® Modular/MQL

new						
Für Ausführung For design	Werkzeugkegel Tool taper		∅ D ₁		Artikel-Nr. Article no.	
Softsynchro® 1 Modular/IKZ Softsynchro® 1 Modular/MQL	Innenkegel Internal taper 60° 	M4,5 - M10	6 / 7		F355188.01	●
		M8, M9, M11, M12	8 / 9		F355188.02	●
		M10	10		F355188.03	●
Softsynchro® 3 Modular/IKZ Softsynchro® 3 Modular/MQL		M12	9		F355388.01	●
		M10 - M16	10 - 12		F355388.02	●
		M18 - M20	14 - 16		F355388.03	●

Von beidenSeiten justierbar, für Werkzeugschäfte mit Außenzentrierung 90°
 Adjustable from both sides, for tool shanks wit male centre 90°

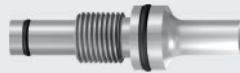

Geeignet für Softsynchro® Modular/MQL

Suitable for Softsynchro® Modular/MQL

new						
Für Ausführung For design	Werkzeugkegel Tool taper		∅ D ₁		Artikel-Nr. Article no.	
Softsynchro® 1 Modular/MQL	Außenkegel External taper 90° 	M4,5 - M6, M8	6		F355188.04	●
		M7, M10	7		F355188.05	●
		M8	8		F355188.06	●
		M12	9		F355188.07	●
		M10	10		F355188.08	●
Softsynchro® 3 Modular/MQL		M12	9		F355388.04	●
		M10	10		F355388.05	●
		M14 - M16	11 - 12		F355388.06	●
		M18	14		F355388.07	●
		M20	16		F355388.08	●

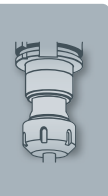

Für Werkzeugschäfte mit Innenzentrierung 60°
For tool shanks with female centre 60°

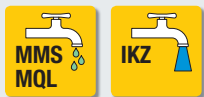

Geeignet für Speedsynchro® Modular/IKZ
und Speedsynchro® Modular/MQL

Suitable for Speedsynchro® Modular/IKZ
and Speedsynchro® Modular/MQL

new							
Für Ausführung For design	Werkzeugkegel Tool taper		$\varnothing D_1$		Artikel-Nr. Article no.		
Speedsynchro® Modular/IKZ Speedsynchro® Modular/MQL	Innenkegel Internal taper 60° 	M4,5 - M10	6 / 7		F375188.01	●	
		M8	8		F375188.02	●	

Für Werkzeugschäfte mit Außenzentrierung 90°
For tool shanks with male centre 90°



Geeignet für Speedsynchro® Modular/MQL

Suitable for Speedsynchro® Modular/MQL

new						
Für Ausführung For design	Werkzeugkegel Tool taper		$\varnothing D_1$		Artikel-Nr. Article no.	
Speedsynchro® Modular/MQL	Außenkegel External taper 90° 	M4,5 - M6. M8	6		F375188.03	●
		M7	7		F375188.04	●
		M8	8		F375188.05	●

Product
Finder

Soft-
synchro

Speed-
synchro

KSN

MQL
MMS

SFM

SWITCH-
MASTER

GR, GR-S

HF

EM

Zubehör
Accessories

Tech. Info



ER-GB

DIN ISO 15488 (DIN 6499)

Mit Vierkantmitnahme
With square drive

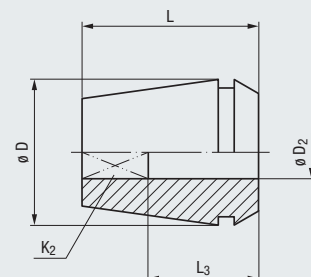
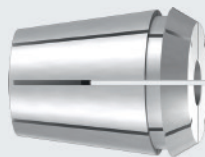

- Product Finder
- Soft-synchro
- Speed-synchro
- KSN
- MQL MMS
- SFM
- SWITCH-MASTER
- GR, GR-S
- HF
- EM
- Zubehör Accessories
- Tech. Info

IKZ

MMS MQL

p_{max}
50bar
(700psi)

p_{max}
100bar
(1400psi)

Typ · Type		ER 11 GB		ER 16 GB		ER 20 GB		ER 25 GB		ER 32 GB		ER 40 GB		ER 50 GB		
		M2 - M8		M4 - M12		M4 - M12		M4 - M20		M4 - M20		M10 - M30		M30 - M42		
$\varnothing D$		11		16		20		25		32		40		51		
L		18		27,5		31,5		34		40		46		60		
DIN				Artikel-Nr. Article no.		Artikel-Nr. Article no.		Artikel-Nr. Article no.		Artikel-Nr. Article no.		Artikel-Nr. Article no.		Artikel-Nr. Article no.		
$\varnothing D_2$	K_2			L ₃	L ₃	L ₃	L ₃	L ₃	L ₃	L ₃	L ₃	L ₃	L ₃	L ₃	L ₃	
2,8	2,1	M2 - M2,6	M4	F0942011.2.8	12											
3,5	2,7	M3	M4,5 - M5	F0942011.3.5	14											
4	3	M3,5	M5,5	F0942011.4	14											
4,5	3,4	M4	M6	F0942011.4.5	14	F0942016.4.5	15	F0942020.4.5	15	F0942025.4.5	15	F0942032.4.5	15			
6	4,9	M4,5 - M6	M8	F0942011.6	14	F0942016.6	18	F0942020.6	18	F0942025.6	18	F0942032.6	18			
7	5,5	M7	M9 - M10			F0942016.7	18	F0942020.7	18	F0942025.7	18	F0942032.7	18			
8	6,2	M8	M11			F0942016.8	22	F0942020.8	22	F0942025.8	22	F0942032.8	22			
9	7	M9	M12			F0942016.9	22	F0942020.9	22	F0942025.9	22	F0942032.9	22	F0942040.9	22	
10	8	M10						F0942020.10	25	F0942025.10	25	F0942032.10	25	F0942040.10	25	
11	9		M14							F0942025.11	25	F0942032.11	25	F0942040.11	25	
12	9		M16							F0942025.12	25	F0942032.12	25	F0942040.12	25	
14	11		M18							F0942025.14	25	F0942032.14	25	F0942040.14	25	
16	12		M20							F0942025.16	25	F0942032.16	25	F0942040.16	25	
18	14,5		M22 - M24											F0942040.18	25	
20	16		M27											F0942040.20	28	
22	18		M30											F0942040.22	28	
25	20		M33												F0942050.22	41
28	22		M36												F0942050.25	41
32	24		M39 - M42												F0942050.28	41
															F0942050.32	41

Weitere Ausführungen auf Anfrage
Further designs upon request

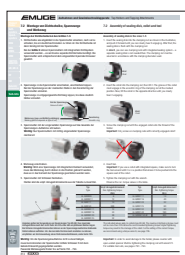

Montage von Dichtscheibe,
Spannzange und Werkzeug
siehe Seite 812

Assembly of sealing disk,
collet and tool,
see page 812

Ohne Vierkantmitnahme
Without square drive

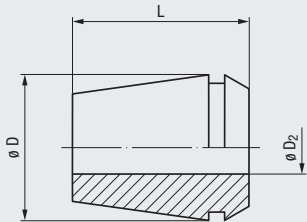
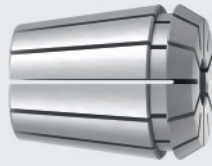

ER
DIN ISO 15488
(DIN 6499)

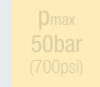

Product Finder

Soft-synchro

Speed-synchro

KSN

MQL MMS

SFM

SWITCH-MASTER

GR, GR-S

HF

EM

Zubehör
Accessories

Tech. Info

Typ · Type	ER 08	ER 11	ER 16	ER 20	ER 32	ER 40	ER 50
	1 - 4,5	1,5 - 7	9 - 10	3 - 11	3 - 18	12 - 22	36
∅ D	8	11	16	20	32	40	50
L	13,6	18	27,5	31,5	40	46	60
∅ D ₂	Artikel-Nr. Article no.	Artikel-Nr. Article no.	Artikel-Nr. Article no.	Artikel-Nr. Article no.	Artikel-Nr. Article no.	Artikel-Nr. Article no.	Artikel-Nr. Article no.
2 - 1,5	F0943008.2 ●	F0943011.2 ●					
2,5 - 2	F0943008.2.5 ●	F0943011.2.5 ●					
3 - 2,5	F0943008.3 ●	F0943011.3 ●					
3 - 2			F0943016.3 ●				
3,5 - 3	F0943008.3.5 ●	F0943011.3.5 ●					
4 - 3,5	F0943008.4 ●	F0943011.4 ●					
4 - 3			F0943016.4 ●	F0943020.4 ●	F0943032.4 ●		
4,5 - 4	F0943008.4.5 ●	F0943011.4.5 ●					
5 - 4,5		F0943011.5 ●					
5 - 4			F0943016.5 ●	F0943020.5 ●	F0943032.5 ●		
6 - 5,5		F0943011.6 ●					
6 - 5			F0943016.6 ●	F0943020.6 ●	F0943032.6 ●		
7 - 6,5		F0943011.7 ●					
7 - 6			F0943016.7 ●	F0943020.7 ●	F0943032.7 ●		
9 - 8			F0943016.9 ●	F0943020.9 ●	F0943032.9 ●		
10 - 9			F0943016.10 ●				
11 - 10				F0943020.11 ●	F0943032.11 ●		
12 - 11					F0943032.12 ●	F0943040.12 ●	
14 - 13					F0943032.14 ●	F0943040.14 ●	
16 - 15					F0943032.16 ●	F0943040.16 ●	
18 - 17					F0943032.18 ●	F0943040.18 ●	
20 - 19						F0943040.20 ●	
22 - 21						F0943040.22 ●	
36 - 34							F0943050.36 ●

Weitere Ausführungen auf Anfrage
Further designs upon request



- Product Finder
- Soft-synchro
- Speed-synchro
- KSN
- MQL MMS
- SFM
- SWITCH-MASTER
- GR, GR-S
- HF
- EM
- Zubehör Accessories

PCM ET1

Mit Vierkantmitnahme und Längenausgleich auf Zug
With square drive and length compensation on tension



IKZ

MMS MQL

p_{max}
50bar
(700psi)

p_{max}
100bar
(1400psi)

T

EM

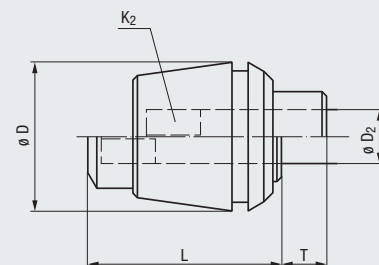

Typ · Type		PCM ET1-12		PCM ET1-20		PCM ET1-32		PCM ET1-40	
		M2 - M4		M2 - M10		M4 - M16		M4,5 - M20	
T		5,5		7		10		13	
ø D		11,5		21		33		41	
L		21,5		31		43		54	

DIN				Artikel-Nr. Article no.		Artikel-Nr. Article no.		Artikel-Nr. Article no.		Artikel-Nr. Article no.	
ø D ₂	K ₂										
2,8	2,1	M2 - M2,6	M4	F0945011.2.8	●	F0945020.2.8	●				
3,5	2,7	M3	M4,5 - M5			F0945020.3.5	●				
4	3	M3,5	M5,5			F0945020.4	●				
4,5	3,4	M4	M6			F0945020.4.5	●	F0945032.4.5	●		
6	4,9	M4,5 - M6	M8			F0945020.6	●	F0945032.6	●	F0945040.6	●
7	5,5	M7	M9 - M10			F0945020.7	●	F0945032.7	●	F0945040.7	●
8	6,2	M8	M11					F0945032.8	●	F0945040.8	●
9	7	M9	M12					F0945032.9	●	F0945040.9	●
10	8	M10						F0945032.10	●	F0945040.10	●
11	9		M14					F0945032.11	●	F0945040.11	●
12	9		M16					F0945032.12	●	F0945040.12	●
14	11		M18							F0945040.14	●
16	12		M20							F0945040.16	●

Die Klemmung des Gewindewerkzeugs erfolgt über 4 Gewindestifte am Vierkant
The threading tool is clamped by means of 4 worm screws on the square

Weitere Ausführungen auf Anfrage
Further designs upon request

Auf Grund des Längenausgleichs können keine Dichtscheiben in die Spannmutter gesetzt werden
Due to the length compensation, sealing disks cannot be used in the clamping nut

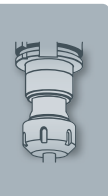

Dichtscheiben
Sealing disks

DS/ER

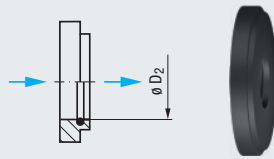

p_{max}
100bar
(1400psi)

Typ · Type		DS/ER 16		DS/ER 20		DS/ER 25		DS/ER 32		DS/ER 40		DS/ER 50		
DIN				Artikel-Nr. Article no.	Artikel-Nr. Article no.	Artikel-Nr. Article no.	Artikel-Nr. Article no.	Artikel-Nr. Article no.	Artikel-Nr. Article no.	Artikel-Nr. Article no.	Artikel-Nr. Article no.	Artikel-Nr. Article no.	Artikel-Nr. Article no.	
$\varnothing D_2$	K_2													
4	3	M3,5	M5,5	F0941516.4	●									
4,5	3,4	M4	M6	F0941516.4.5	●	F0941520.4.5	●	F0941525.4.5	●	F0941532.4.5	○			
6	4,9	M4,5 - M6	M8	F0941516.6	●	F0941520.6	●	F0941525.6	●	F0941532.6	●			
7	5,5	M7	M9 - M10	F0941516.7	●	F0941520.7	●	F0941525.7	●	F0941532.7	●			
8	6,2	M8	M11	F0941516.8	●	F0941520.8	●	F0941525.8	●	F0941532.8	●			
9	7	M9	M12	F0941516.9	●	F0941520.9	●	F0941525.9	●	F0941532.9	●	F0941540.9	●	
10	8	M10		F0941516.10	●	F0941520.10	●	F0941525.10	●	F0941532.10	●	F0941540.10	●	
11	9		M14					F0941525.11	●	F0941532.11	●	F0941540.11	●	
12	9		M16					F0941525.12	●	F0941532.12	●	F0941540.12	●	
14	11		M18					F0941525.14	●	F0941532.14	●	F0941540.14	●	
16	12		M20					F0941525.16	●	F0941532.16	●	F0941540.16	●	
18	14,5		M22 - M24									F0941540.18	●	
20	16		M27									F0941540.20	●	
22	18		M30									F0941540.22	●	
25	20		M33										F0941550.22	●
28	22		M36										F0941550.25	●
32	24		M39 - M42										F0941550.28	●
36	29		M45 - M48										F0941550.32	●
													F0941550.36	●

Kùhlscheiben
Coolant flush disks

KS/ER

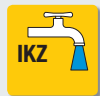
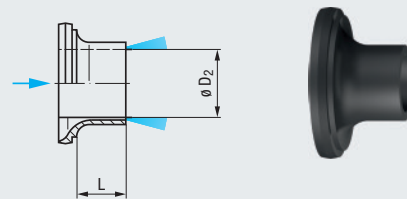

p_{max}
100bar
(1400psi)

Typ · Type		KS/ER 16		KS/ER 20		KS/ER 32				
DIN				Artikel-Nr. Article no.	L	Artikel-Nr. Article no.	L	Artikel-Nr. Article no.	L	
$\varnothing D_2$	K_2									
4	3	M3,5	M5,5	F0941716.4	11	●				
6	4,9	M4,5 - M6	M8	F0941716.6	11	●	F0941720.6	11	●	
7	5,5	M7	M9 - M10	F0941716.7	11	●	F0941720.7	11	●	
8	6,2	M8	M11	F0941716.8	11	●	F0941720.8	11	●	
9	7	M9	M12	F0941716.9	11	●	F0941720.9	11	●	
10	8	M10		F0941716.10	2	●	F0941720.10	11	●	
11	9		M14					F0941732.10	11	●
12	9		M16					F0941732.11	11	●
14	11		M18					F0941732.12	11	●
16	12		M20					F0941732.14	11	●
								F0941732.16	11	●

● = Lagerwerkzeug, siehe Preisliste · Stock tool, see price list
○ = Kurzfristig lieferbar, Preis auf Anfrage · Available on short notice, price upon inquiry

- Product Finder
- Soft-synchro
- Speed-synchro
- KSN
- MQL MMS
- SFM
- SWITCH-MASTER
- GR, GR-S
- HF
- EM
- Zubehôr
Accessories
- Tech. Info

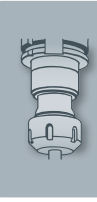

- Product Finder
- Soft-synchro
- Speed-synchro
- KSN
- MQL MMS
- SFM
- SWITCH-MASTER
- GR, GR-S
- HF
- EM
- Zubehör Accessories
- Tech. Info

Hi-Q/ERM

Ohne Abdichtung
Without sealing



p_{max}
100bar
(1400psi)

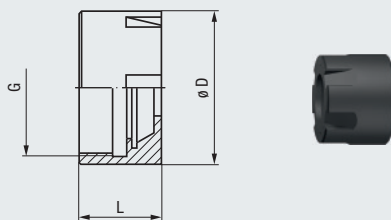

Typ · Type	Hi-Q/ERM 8	Hi-Q/ERM 11
$\emptyset D$	12	16
L	10,8	12
G	M10 x 0,75	M13 x 0,75
Für Spannzange For collet	Artikel-Nr. Article no.	Artikel-Nr. Article no.
ER 08	F0940308	F0940311
ER 11 (GB)		

Hi-Q/ERMC

Mit integrierter Abdichtung
With integrated sealing



p_{max}
100bar
(1400psi)

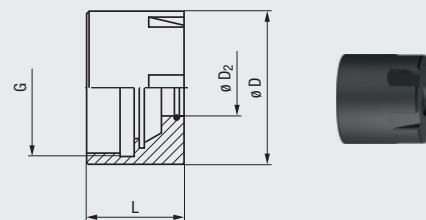

Typ · Type	Hi-Q/ERMC 11	
$\emptyset D$	16	
L	14,6	
G	M13 x 0,75	
DIN		
$\emptyset D_2$ K ₂	Für Spannzange For collet	Artikel-Nr. Article no.
6 4,9 M4,5 - M6 M8	ER 11 (GB)	F0943511.6
7 5,5 M7 M9 - M10	ER 11 (GB)	F0943511.7

Hi-Q/ERMC

Für Dichtscheiben
For sealing disks



p_{max}
100bar
(1400psi)

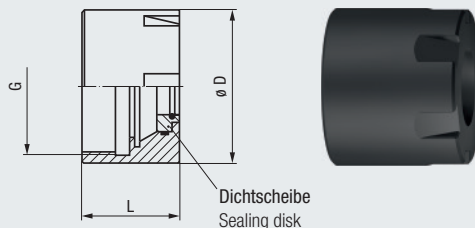

Typ · Type	Hi-Q/ERMC 16	Hi-Q/ERMC 20	Hi-Q/ERMC 25
$\emptyset D$	22	28	35
L	22	24	25
G	M19 x 1	M24 x 1	M30 x 1
Für Spannzange For collet	Dichtscheibe Sealing disk	Artikel-Nr. Article no.	Artikel-Nr. Article no.
ER 16 (GB)	DS/ER 16	F0943516	F0943520
ER 20 (GB)	DS/ER 20		F0943525
ER 25 (GB)	DS/ER 25		

Dichtscheiben sind nicht im Lieferumfang enthalten, bitte extra bestellen (siehe Seite 789)
Sealing disks are not included in the delivery, please order separately (see page 789)



Ohne Abdichtung
Without sealing

Hi-Q/ER

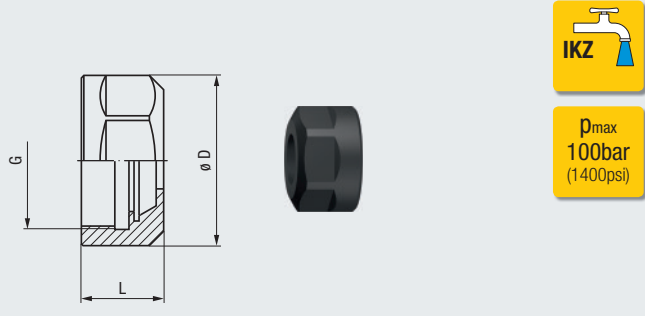

p_{max}
100bar
(1400psi)

Typ · Type	Hi-Q/ER 11	
ø D	19	
L	11,3	
G	M14 x 0,75	
Für Spannzange For collet	Artikel-Nr. Article no.	
ER 11 (GB)	F0940911	●

Mit integrierter Abdichtung
With integrated sealing

Hi-Q/ERC

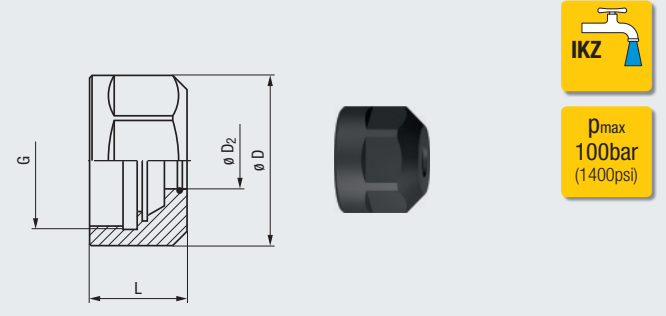

p_{max}
100bar
(1400psi)

Typ · Type	Hi-Q/ERC 11	
ø D	19	
L	14,6	
G	M14 x 0,75	
DIN		
ø D ₂	K ₂	für Spannzange for collet
6	4,9	M4,5 - M6
7	5,5	M7
		Artikel-Nr. Article no.
		ER 11 (GB)
		ER 11 (GB)
		F0940711.6
		F0940711.7

Für Dichtscheiben
For sealing disks

Hi-Q/ERC

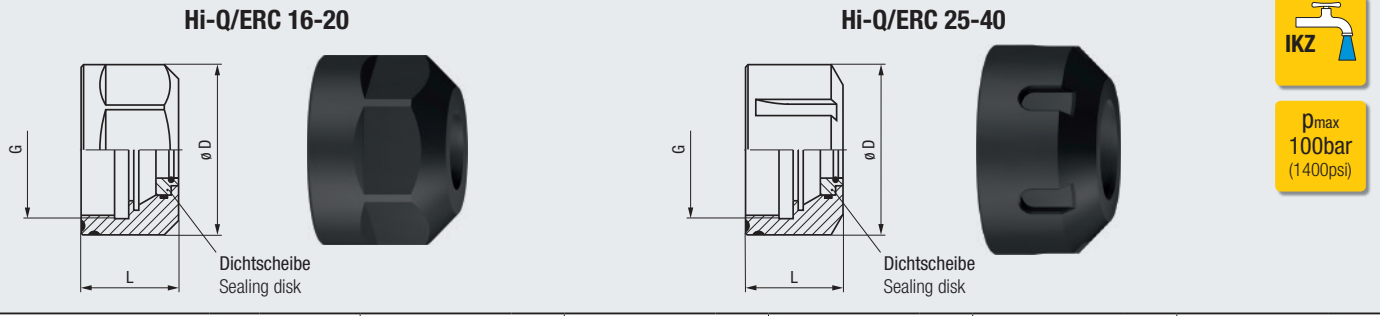

p_{max}
100bar
(1400psi)

Typ · Type		Hi-Q/ERC 16	Hi-Q/ERC 20	Hi-Q/ERC 25	Hi-Q/ERC 32	Hi-Q/ERC 40
ø D		28	34	42	50	63
L		22,5	24	25	27,5	30,5
G		M22 x 1,5	M25 x 1,5	M32 x 1,5	M40 x 1,5	M50 x 1,5
Für Spannzange For collet	Dichtscheibe Sealing disk	Artikel-Nr. Article no.	Artikel-Nr. Article no.	Artikel-Nr. Article no.	Artikel-Nr. Article no.	Artikel-Nr. Article no.
ER 16 (GB)	DS/ER 16	F0940716	●			
ER 20 (GB)	DS/ER 20		F0940720	●		
ER 25 (GB)	DS/ER 25			F0940725	●	
ER 32 (GB)	DS/ER 32				F0940732	●
ER 40 (GB)	DS/ER 40					F0940740

Dichtscheiben sind nicht im Lieferumfang enthalten, bitte extra bestellen (siehe Seite 789)
Sealing disks are not included in the delivery, please order separately (see page 789)

- Product Finder
- Soft-synchro
- Speed-synchro
- KSN
- MQL MMS
- SFM
- SWITCH-MASTER
- GR, GR-S
- HF
- EM
- Zubehör
Accessories
- Tech. Info

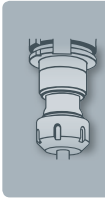

Für Dichtscheiben
For sealing disks

Hi-Q/ERBC



p_{max}
100bar
(1400psi)

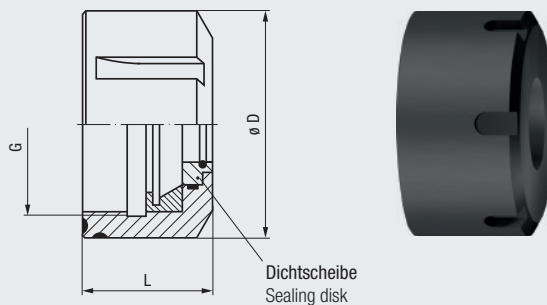

Dichtscheibe
Sealing disk

Typ · Type		Hi-Q/ERBC 50 AF					
	ø D	77,7					
	L	42,5					
	G	M64 x 2					
Für Spannzange For collet	Dichtscheibe Sealing disk	Artikel-Nr. Article no.					
ER 50 (GB)	DS/ER 50	F0941650	●				

Dichtscheiben sind nicht im Lieferumfang enthalten, bitte extra bestellen (siehe Seite 789)
Sealing disks are not included in the delivery, please order separately (see page 789)

Spannschlüsselsätze
Sets of clamping wrenches

Softsynchro®

Softsynchro® Micro, Softsynchro® 0



Softsynchro® 1

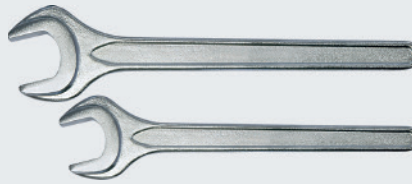

Softsynchro® 3, Softsynchro® 4



Softsynchro® 5



Product Finder

Softsynchro

Speedsynchro

KSN

MQL MMS

SFM

SWITCH-MASTER

GR, GR-S

HF

EM

Zubehör
Accessories

Tech. Info

Für Spannzangen-Aufnahmen For collet holders	Bestandteile Components	Artikel-Nr. Article no.	
Softsynchro® Micro	E8M / SW8	F315098.03	●
Softsynchro® 0	E11M / SW14	F315098.02	●
Softsynchro® 1	SW30 / SW19	F315198.02	●
Softsynchro® 1 für angetriebene Werkzeuge · for driven tools	SW25 / SW17	F315198.03	●
Softsynchro® 3	E32 / SW32	F315398.01	●
Softsynchro® 4	E40 / SW41	F315498.01	●
Softsynchro® 5	E50	F315598.02	●

Montagevorrichtung
Assembly device

Softsynchro®

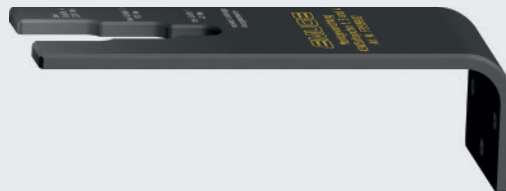

Für Spannzangen-Aufnahmen For collet holders	Artikel-Nr. Article no.	
Softsynchro® 1 - Softsynchro® 4	F315199.02	●

Montagevorrichtung
Assembly device

Speedsynchro® Modular



Für Spannzangen-Aufnahmen mit integrierter Übersetzung For collet holders with integrated transmission	Artikel-Nr. Article no.	
Speedsynchro® Modular	F3741909	●



- Product Finder
- Soft-synchro
- Speed-synchro
- KSN
- ML MMS
- SFM
- SWITCH-MASTER
- GR, GR-S
- HF
- EM
- Zubehör Accessories
- Tech. Info

KSN/HD/ER

Spannschlüsselsätze
Sets of clamping wrenches

KSN 1/HD/ER

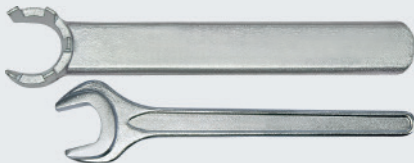

KSN 3/HD/ER



	Für Spannzangen-Aufnahmen For collet holders	Bestandteile Components	Artikel-Nr. Article no.	
	KSN 1/HD/ER	E20M / SW24	F323198.01	●
	KSN 3/HD/ER	E32 / SW34	F323398.01	●

EM-L/ER/IKZ

Spannschlüsselsätze
Sets of clamping wrenches

EM 00-L/ER/IKZ - EM 03-L/ER/IKZ



	Für Spannzangen-Aufnahmen For collet holders	Bestandteile Components	Artikel-Nr. Article no.	
	EM 00-L/ER/IKZ	E11M / SW11	F350098.01	●
	EM 01-L/ER/IKZ	E16M / SW17	F350198.01	●
	EM 03-L/ER/IKZ	E25M / SW26	F350398.01	●

Hi-Q/ER, Hi-Q/ERC

Spannschlüssel
Clamping wrenches

Hi-Q/ER 11, Hi-Q/ERC 20



Hi-Q/ERC 32, Hi-Q/ERC 40



	Für Spannmuttern For clamping nuts	Artikel-Nr. Article no.	
	Hi-Q/ER 11	QB002002.00170	●
	Hi-Q/ERC 20	QB002002.00300	●
	Hi-Q/ERC 32	QB002003.0320	●
	Hi-Q/ERC 40	QB002003.0400	●

Drehmomentschlüssel
Torque wrenches

TORCO-FIX

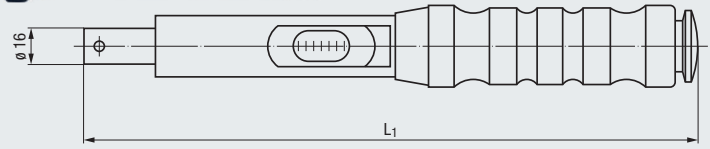

Typ Type	Drehmoment Torque		L_1	Artikel-Nr. Article no.	
	Nm				
TORCO-FIX 0	2 - 25		290	F0908002	●
TORCO-FIX I	10 - 50		335	F0908005	●
TORCO-FIX II	20 - 200		465	F0908020	●
TORCO-FIX III	60 - 300		565	F0908060	●

Typ Type	Für Spannmutter For clamping nut	TORCO-FIX	A	B	Artikel-Nr. Article no.	
A-E 11 M	Hi-Q/ERMC 11, Hi-Q/ERM 11	0	16,8	54	F0908500.AE11M	●
A-E 16 M	Hi-Q/ERMC 16	I, II	22,5	56	F0908500.AE16M	●
A-E 20 M	Hi-Q/ERMC 20	I, II	29	68	F0908500.AE20M	●
A-E 25 M	Hi-Q/ERMC 25	II	36	70	F0908500.AE25M	●

Aufsteckschlüssel
Shell-type wrenches

A-EM

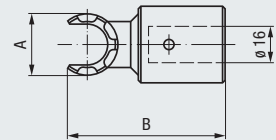

Typ Type	Für Spannmutter For clamping nut	TORCO-FIX	A	B	Artikel-Nr. Article no.	
A-E 16 P	Hi-Q/ERC 16	I, II	44	71	F0908500.AE16P	●
A-E 20 P	Hi-Q/ERC 20	I, II	52	81	F0908500.AE20P	●

Aufsteckschlüssel
Shell-type wrenches

A-EP

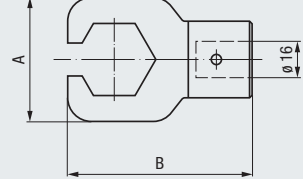

Typ Type	Für Spannmutter For clamping nut	TORCO-FIX	A	B	Artikel-Nr. Article no.	
A-E 32	Hi-Q/ERC 32	II, III	80	72	F0908500.AE32	●
A-E 40	Hi-Q/ERC 40	III	96	82	F0908500.AE40	●
A-E 50	Hi-Q/ERC 50	III	111	94	F0908500.AE50	●

Aufsteckschlüssel
Shell-type wrenches

A-E

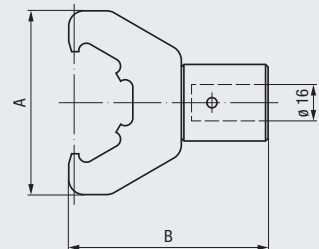
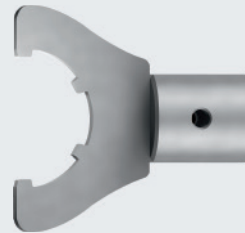

Typ Type	Größe für Spezial-Schaftverlängerung Size for special shank extension	TORCO-FIX	A	B	Artikel-Nr. Article no.	
A-SW 8	02	0	20,5	55	F0908500.08	●
A-SW 9	03, 04	0	20,5	55	F0908500.09	●
A-SW 12	05, 06	0	29	57	F0908500.12	●
A-SW 13	07	0	34,5	59	F0908500.13	●
A-SW 15	08, 09	0	34,5	59	F0908500.15	●
A-SW 18	10, 11	0, I	41,5	59	F0908500.18	●
A-SW 22	12, 13	I	56	64	F0908500.22	●
A-SW 26	14	II	56	64	F0908500.26	●
A-SW 28	15	II	68	65	F0908500.28	●
A-SW 30	16	II	68	65	F0908500.30	●
A-SW 36	17	II	68	65	F0908500.36	●

Aufsteckschlüssel
Shell-type wrenches

A-SW

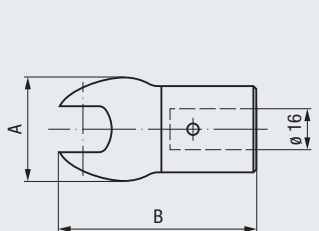
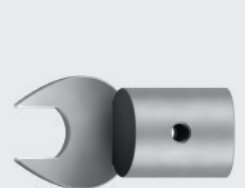

● = Lagerwerkzeug, siehe Preisliste · Stock tool, see price list
○ = Kurzfristig lieferbar, Preis auf Anfrage · Available on short notice, price upon inquiry



- Product Finder
- Soft-synchro
- Speed-synchro
- KSN
- MQL MMS
- SFM
- SWITCH-MASTER
- GR, GR-S
- HF
- EM
- Zubehör Accessories
- Tech. Info

PGR-GB

Mit Vierkantmitnahme und Längennachstellung
With square drive and length adjustment







ρ_{max}
50bar
(700psi)



ρ_{max}
100bar
(1400psi)

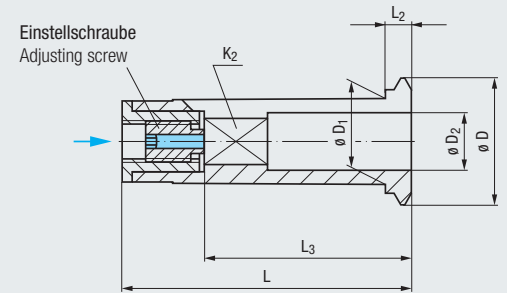





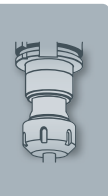

Typ · Type	PGR 15 GB	PGR 25 GB
	M4 - M12	M8 - M20
ø D	22	33
ø D ₁	15	25
L	50,5	60,5
L ₂	4,5	6

DIN				Artikel-Nr. Article no.	L ₃			Artikel-Nr. Article no.	L ₃		
ø D ₂	K ₂				min.	max.			min.	max.	
4,5	3,4	M4	M6	F0942615.4.5	27	29	●				
6	4,9	M4,5 - M6	M8	F0942615.6	29	31	●				
7	5,5	M7	M9 - M10	F0942615.7	29	31	●				
8	6,2	M8	M11	F0942615.8	33,5	36	●	F0942625.8	33,5	36	●
9	7	M9	M12	F0942615.9	34,5	37	●	F0942625.9	34,5	37	●
10	8	M10		F0942615.10	35,5	38	●	F0942625.10	38,5	41	●
11	9		M14					F0942625.11	39,5	42	●
12	9		M16					F0942625.12	39,5	42	●
14	11		M18					F0942625.14	41,5	44	●
16	12		M20					F0942625.16	42,5	45	●





PGR-Spannzangen ohne Vierkantmitnahme auf Anfrage

PGR collets without square drive upon request

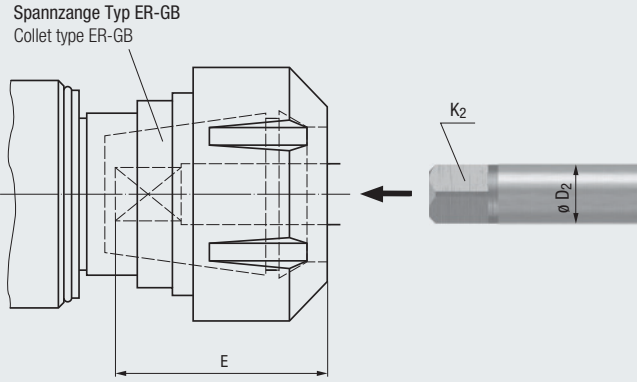

Spannzangen Collets		ER 8		ER 11 GB			ER 16 GB		
Spannmuttern Clamping nuts		Hi-Q/ERM 8		Hi-Q/ERM 11	Hi-Q/ER 11	Hi-Q/ERMC 11 Hi-Q/ERC 11	Hi-Q/ERMC 16 Hi-Q/ERC 16		
DIN		Einstecktiefen E Clamping depths E				Einstecktiefen E Clamping depths E			
ø D ₂	K ₂			min.	max.				
2	–	M0,5 - M0,9		9	20				
2,2	–		M3	9	20				
2,5	2,1	M1 - M1,8	M3,5	14	20				
2,8	2,1	M2 - M2,6	M4	15	20	18	17	21	
3,5	2,7	M3	M4,5 - M5	15	19,5	21	20	24	
4	3	M3,5	M5,5	15	19	21	20	24	
4,5	3,4	M4	M6	15	19	21	20	24	29
6	4,9	M4,5 - M6	M8			23	22	26	31
7	5,5	M7	M9 - M10						31
8	6,2	M8	M11						36
9	7	M9	M12						37 / 48 ¹⁾
10	8	M10							43 ¹⁾

¹⁾ In Kombination mit Spannzangen Typ ER 16 und Softsynchro® 1 für angetriebene Werkzeuge
In combination with collets type ER 16 and Softsynchro® 1 for driven tools

Spannzangen Collets		ER 20 GB		ER 25 GB		ER 32 GB		ER 40 GB		ER 50 GB	
Spannmuttern Clamping nuts		Hi-Q/ERMC 20 Hi-Q/ERC 20		Hi-Q/ERMC 25 Hi-Q/ERC 25		Hi-Q/ERC 32		Hi-Q/ERC 40		Hi-Q/ERBC 50 AF	
DIN		Einstecktiefen E Clamping depths E									
ø D ₂	K ₂										
4,5	3,4	M4	M6	26	26	26					
6	4,9	M4,5 - M6	M8	31	31	31					
7	5,5	M7	M9 - M10	31	31	31					
8	6,2	M8	M11	36	36	36					
9	7	M9	M12	37	37	37			37		
10	8	M10		41	41	41			41		
11	9		M14		42	42			42		
12	9		M16		42	42			42		
14	11		M18		44	44			44		
16	12		M20		45	45			45		
18	14,5		M22 - M24						47		
20	16		M27						52		
22	18		M30						54		
25	20		M33								70
28	22		M36								72
32	24		M39 - M42								74
36	29		M45 - M48								76
											111 ²⁾

²⁾ In Kombination mit Spannzangen Typ ER 50 und Softsynchro® 5
In combination with collets type ER 50 and Softsynchro® 5

- Product Finder
- Softsynchro
- Speedsynchro
- KSN
- MQL MMS
- SFM
- SWITCH-MASTER
- GR, GR-S
- HF
- EM
- Zubehör Accessories
- Tech. Info



- Product Finder
- Soft-synchro
- Speed-synchro
- KSN
- MQL MMS
- SFM
- SWITCH-MASTER
- GR, GR-S
- HF
- EM
- Zubehör Accessories
- Tech. Info

DEU

Einarmer Drehmomentschlüssel Single-armed torque wrench

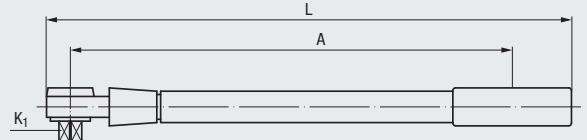

Typ Type	Für Einsatzgröße For adapter size	Drehmoment Torque Nm	Messbereich Measuring range	A	L	K ₁	Artikel-Nr. Article no.	
DEU-00/1	00	0 - 6	M2 - M6 (Nr.2 - Nr.12)	220	260	1/4"	F0900001	●
DEU-00/1	00/01 (03)	3 - 25	M6 - M12 (Nr.10 - 7/16)	200	245	3/8"	F0900004	●
DEU-10/1	03/04	20 - 200	M12 - M27 (7/16 - 1")	410	500	1/2"	F0901002	●
DEU-20/1	04/05	70 - 700	M24 - M52 (7/8 - 1 3/4)	1150	1260	3/4"	F0902002	●

DEU

Zweiarmiger Drehmomentschlüssel Double-armed torque wrench

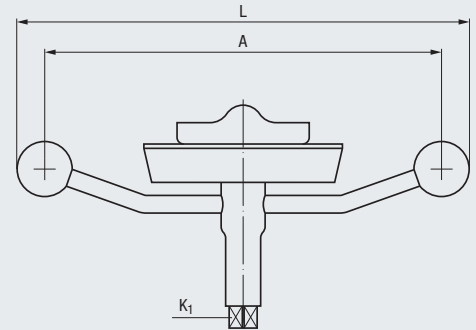

Typ Type	Für Einsatzgröße For adapter size	Drehmoment Torque Nm	Messbereich Measuring range	A	L	K ₁	Artikel-Nr. Article no.	
DEU-00	00/01 (03)	3 - 23	M6 - M12 (Nr.10 - 7/16)	180	205	3/8"	F0900000	○
DEU-10	03/04	20 - 180	M12 - M27 (7/16 - 1")	620	656	1/2"	F0901000	○
DEU-20	04/05	70 - 700	M24 - M52 (7/8 - 1 3/4)	1150	1300	3/4"	F0902000	○

AEU

Aufnahmekopf Adapter head

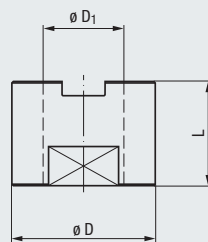
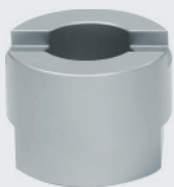

Typ Type	Für Einsatzgröße For adapter size	ø D	ø D ₁	L	Artikel-Nr. Article no.	
AEU-00	00	25	13	25	F0920000	●
AEU-01	01	35	19	28	F0921000	●
AEU-03	03	55	31	40	F0923000	●
AEU-04	04	75	48	60	F0924000	●
AEU-05	05	100	60	70	F0925000	●

VS

Stirnlochschlüssel Spanner with pins

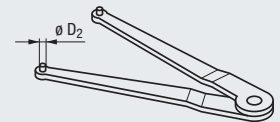

Typ Type	Für Einsatzgröße For adapter size	ø D ₂	Artikel-Nr. Article no.	
VS-00	00	2	F0930000	●
VS-01	01	2,5	F0931000	●
VS-03	03	4	F0933000	●
VS-04	04	5	F0934000	●
VS-05	05	6	F0935000	●

Der Aufnahmekopf dient zur Aufnahme der Schnellwechsel-Einsätze und wird mit seiner Schlüssel­fläche in einen Schraubstock gespannt.
The adapter head serves for holding the quick-change adapters and features clamping flats for holding in a vise.

VEU



Vierkantbolzen
Square pin



Typ Type	Für Drehmomentschlüssel For torque wrench	K ₁ inch	Ø D ₂ mm	K ₂ mm	Artikel-Nr. Article no.	
VEU-00	DEU-00	3/8"	2,5	2,1	F0910100	●
			2,8	2,1	F0910101	●
			3,5	2,7	F0910102	●
			4	3	F0910103	●
			4,5	3,4	F0910104	●
			6	4,9	F0910106	●
			7	5,5	F0910107	●
			8	6,2	F0910108	●
			9	7	F0910109	●
			10	8	F0910110	●
			11	9	F0910111	●
			12	9	F0910112	●
			14	11	F0910113	●
			16	12	F0910114	●
			18	14,5	F0910115	●
VEU-10	DEU-10	1/2"	4,5	3,4	F0911104	●
			6	4,9	F0911106	●
			7	5,5	F0911107	●
			8	6,2	F0911108	●
			9	7	F0911109	●
			10	8	F0911110	●
			11	9	F0911111	●
			12	9	F0911112	●
			14	11	F0911113	●
			16	12	F0911114	●
			18	14,5	F0911115	●
			20	16	F0911116	●
			22	18	F0911117	●
25	20	F0911118	●			
28	22	F0911119	●			
32	24	F0911120	●			
36	29	F0911121	●			
VEU-20	DEU-20	3/4"	18	14,5	F0912115	●
			20	16	F0912116	●
			22	18	F0912117	●
			25	20	F0912118	●
			28	22	F0912119	●
			32	24	F0912120	●
			36	29	F0912121	●
			40	32	F0912122	●
45	35	F0912123	●			

Diese Vierkantbolzen stellen die Verbindung zwischen Drehmomentschlüssel und Schnellwechsel-Einsatz her, wobei das Vierkant K₁ in das Vierkant des Drehmomentschlüssels eingesteckt und der Schaft D₂ mit Vierkant K₂ in den Einsatz eingespannt wird
 These square pins establish the connection between torque wrench and adapter: the square K₁ is inserted into the square seat of the torque wrench, and the shank end D₂ with square K₂ is clamped in the adapter

- Product Finder
- Soft-synchro
- Speed-synchro
- KSN
- MOQ MMS
- SFM
- SWITCH-MASTER
- GR, GR-S
- HF
- EM
- Zubehör Accessories
- Tech. Info

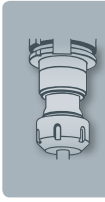

- Product Finder
- Soft-synchro
- Speed-synchro
- KSN
- MQL MMS
- SFM
- SWITCH-MASTER
- GR, GR-S
- HF
- EM
- Zubehör Accessories
- Tech. Info

Einstellen und Prüfen der Überlastkupplung von Schnellwechsel-Einsätzen der Typen EM-U, EM-UL und HF:

Grundsätzlich richtet sich das einzustellende Drehmoment nach

- Abmessung
- Geometrie und Beschichtung des Werkzeuges
- Zu bearbeitender Werkstoff
- Art und Qualität des Kühlschmierstoffes
- Kernlochdurchmesser

Die Tabelle zeigt Richtwerte zum Gewindebohren in Stahl mit einer Zugfestigkeit von 600-800 N/mm².

Eventuell müssen die Einstellwerte dem jeweiligen Bearbeitungsfall angepasst werden (z.B. beim Gewindeformen).

Setting and checking of the overload clutch on quick-change adapters of types EM-U, EM-UL and HF:

Generally speaking, the torque to be set depends on

- Size
- Geometry and coating of the tool
- Workpiece material
- Type and quality of the coolant-lubricant
- Drilled hole diameter

The table contains standard values for thread cutting in steel with a tensile strength of 600-800 N/mm².

These values generally need to be adjusted to the individual work case (e.g. for cold-forming of threads).

Drehmoment Torque		Gewindesystem Thread system								
Nm	Ft. lbs	M	UNC	UNF	BSW	BSF	G (Whw.)	NPT NPTF	Rc (BSPT)	Pg
0,3	0,2	M2	Nr. 2	Nr. 2						
0,4	0,3	M2,5		Nr. 3						
0,5	0,4		Nr. 3	Nr. 4						
0,6	0,5	M3								
0,8	0,6		Nr. 4	Nr. 5						
1	0,7	M3,5	Nr. 5	Nr. 6	1/8					
1,2	0,9		Nr. 6	Nr. 8						
1,6	1,2	M4	Nr. 8		5/32					
2	1,5			Nr. 10						
2,5	1,8	M5		Nr. 12		3/16				
3	2,2		Nr. 10	1/4						
4	3		Nr. 12		3/16	7/32				
5	3,7	M6		5/16	7/32	1/4				
6	4,4		1/4	3/8	1/4	9/32	G 1/8			
8	6					5/16				
10	7,4	M8	5/16	7/16	5/16					
12	8,9			1/2		3/8				
16	12		3/8		3/8			1/16	Rc 1/16	Pg 7
18	13	M10		9/16		7/16	G 1/4			
20	15			5/8						
22	16		7/16		7/16		G 3/8			Pg 9
25	18	M12				1/2		1/8	Rc 1/8	Pg 11
28	21									Pg 13,5
32	24		1/2	3/4	1/2	9/16				Pg 16
40	30		9/16		9/16	5/8				
45	33	M14		7/8		11/16				Pg 21
50	37	M16	5/8		5/8		G 1/2			
56	41						G 5/8		Rc 1/4	
63	46							1/4		Pg 29
70	52		3/4	1"	3/4	3/4	G 3/4			
80	59	M18		1 1/8		13/16	G 7/8			Pg 36
90	66	M20		1 1/4		7/8		3/8	Rc 3/8	Pg 42
100	74	M22	7/8	1 3/8	7/8					Pg 48
110	81			1 1/2						
125	92					1"				
140	103	M24	1"		1"		G 1"			
160	118	M27					G 1 1/8	1/2	Rc 1/2	
180	133						1 1/8	G 1 1/4		
200	148						1 1/4	G 1 3/8	3/4	Rc 3/4

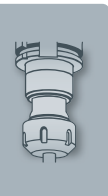

Einstellen und Prüfen der Überlastkupplung von Schnellwechsel-Einsätzen der Typen EM-U, EM-UL und HF:

Grundsätzlich richtet sich das einzustellende Drehmoment nach

- Abmessung
- Geometrie und Beschichtung des Werkzeuges
- Zu bearbeitender Werkstoff
- Art und Qualität des Kühlschmierstoffes
- Kernlochdurchmesser

Die Tabelle zeigt Richtwerte zum Gewindebohren in Stahl mit einer Zugfestigkeit von 600-800 N/mm².

Eventuell müssen die Einstellwerte dem jeweiligen Bearbeitungsfall angepasst werden (z.B. beim Gewindeformen).

Setting and checking of the overload clutch on quick-change adapters of types EM-U, EM-UL and HF:

Generally speaking, the torque to be set depends on

- Size
- Geometry and coating of the tool
- Workpiece material
- Type and quality of the coolant-lubricant
- Drilled hole diameter

The table contains standard values for thread cutting in steel with a tensile strength of 600-800 N/mm².

These values generally need to be adjusted to the individual work case (e.g. for cold-forming of threads).

Drehmoment Torque		Gewindesystem Thread system								
Nm	Ft. lbs	M	UNC	UNF	BSW	BSF	G (Whw.)	NPT NPTF	Rc (BSPT)	Pg
220	162	M30	1 1/8		1 1/8		G 1 1/2			
240	177	M33	1 1/4		1 1/4		G 1 3/4			
260	192					1 3/8	G 2"			
280	207	M36								
300	221					1 1/2	G 2 1/4			
320	236	M39				1 5/8				
340	250		1 3/8		1 3/8		G 2 1/2	1"	Rc 1"	
360	266		1 1/2		1 1/2		G 2 3/4			
400	295	M42					G 3"			
420	310	M45					G 3 1/4			
450	332					1 3/4	G 3 1/2	1 1/4	Rc 1 1/4	
480	354						G 3 3/4			
500	369					2"	G 4"			
560	413	M48			1 5/8			1 1/2	Rc 1 1/2	
630	465	M52	1 3/4		1 3/4					
710	524	M56				2 1/4		2"	Rc 2"	
800	590	M60			1 7/8	2 1/2				
900	664	M64				2 3/4				
1000	738	M68	2"		2"					
1100	811		2 1/4		2 1/4	3"				
1170	863	M72								
1230	907	M76								
1300	959	M80								
1380	1018	M85								
1400	1033		2 1/2		2 1/2			2 1/2	Rc 2 1/2	
1460	1077	M90								
1540	1136	M95								
1620	1195	M100								
1700	1254	M105								
1780	1313	M110								
1860	1372	M115								
1940	1431	M120								
2000	1475		2 3/4		2 3/4			3"	Rc 3"	
2020	1490	M125								
2110	1556	M130								
2200	1623				3"					
2270	1674	M140								
2430	1792	M150								
2680	1977	M160								

- Product Finder
- Soft-synchro
- Speed-synchro
- KSN
- MQL MMS
- SFM
- SWITCH-MASTER
- GR, GR-S
- HF
- EM
- Zubehör Accessories
- Tech. Info

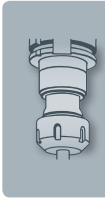

- Product Finder
- Soft-synchro
- Speed-synchro
- KSN
- MQL MMS
- SFM
- SWITCH-MASTER
- GR, GR-S
- HF
- EM
- Zubehör Accessories
- Tech. Info

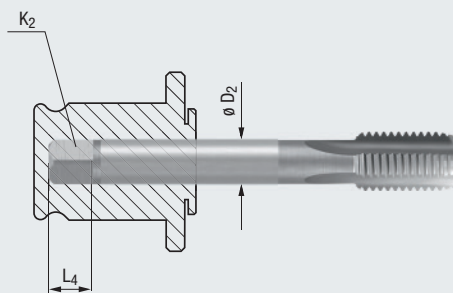

DIN			ISO		
ø D ₂ mm	K ₂ mm	L ₄ mm	ø D ₂ mm	K ₂ mm	L ₄ mm
2,5	2,1	5	2,24	1,8	4
2,8	2,1	5	2,5	2	4
3,5	2,7	6	2,8	2,24	5
4	3	6	3,15	2,5	5
4,5	3,4	6	3,55	2,8	5
6	4,9	8	4	3,15	6
7	5,5	8	4,5	3,55	6
8	6,2	9	5	4	7
9	7	10	5,6	4,5	7
10	8	11	6,3	5	8
11	9	12	7,1	5,6	8
12	9	12	8	6,3	9
14	11	14	9	7,1	10
16	12	15	10	8	11
18	14,5	17	11,2	9	12
20	16	19	12,5	10	13
22	18	21	14	11,2	14
25	20	23	16	12,5	16
28	22	25	18	14	18
32	24	27	20	16	20
36	29	32	22,4	18	22
40	32	35	25	20	24
45	35	38	28	22,4	26
			31,5	25	28
			35,5	28	31
			40	31,5	34
			45	35,5	38

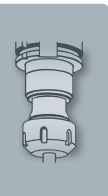

Technische Informationen**Technical Information**

Seite · Page

7.1	Symbolbeschreibungen der Leistungsmerkmale Description of the symbols for performance characteristics	804 - 811
7.2	Montage von Dichtscheibe, Spannzange und Werkzeug Assembly of sealing disk, collet and tool	812
7.3	Übersicht der Kegel-Hohlschäfte mit Plananlage (HSK) Overview of hollow taper shanks with flange contact surface (HSK)	813
7.4	Synchrone Gewindeherstellung Rigid tapping	814 - 820
7.5	Spannzangen-Aufnahmen Softsynchro® Modular Collet holders Softsynchro® Modular	821 - 822
7.6	Minimalmengenschmierung (MMS) Minimum-quantity lubrication (MQL)	823 - 824
7.7	Spannzangen-Aufnahmen Speedsynchro® Modular Collet holders Speedsynchro® Modular	825 - 827
7.8	Werkzeugüberwachungssystem DDU4 Tool monitoring system DDU4	828
7.9	Gewindeschneidapparate SWITCH-MASTER® Tapping attachments SWITCH-MASTER®	829 - 832
7.10	Einstellen der Überlastkupplung bei Schnellwechsel-Aufnahmen Typ HF Adjusting the overload clutch of quick-change tap holders type HF	833 - 834
7.11	Reinigung von Spannzangen-Aufnahme und Spannzange Typ PGR Cleaning of collet holder and collet type PGR	835
7.12	Längeneinstellung von Spannzangen-Aufnahmen Typ PGR Length adjustment of collet holders type PGR	836

Product
FinderSoft-
synchroSpeed-
synchro

KSN

MQL
MMS

SFM

SWITCH-
MASTER

GR, GR-S

HF

EM

Zubehör
Accessories**Tech. Info**

Die Technischen Informationen der jeweiligen Kapitel dieses Kataloges sind in vielen Landessprachen auch als separate Druckerzeugnisse verfügbar. Bitte wenden Sie sich an den für Sie zuständigen Vertriebspartner.

The technical information complementing the various chapters of this catalogue is available also as a separate printed booklet in many different languages. Please speak to your usual sales contact.



- Product Finder
- Soft-synchro
- Speed-synchro
- KSN
- MQL MMS
- SFM
- SWITCH-MASTER
- GR, GR-S
- HF
- EM
- Zubehör Accessories
- Tech. Info

7.1 Symbolbeschreibung der Leistungsmerkmale



Innere Kühlschmierstoff-Zufuhr (IKZ)

Ist eine Werkzeugmaschine mit innerer Kühlschmierstoff-Zufuhr durch die Maschinenspindel ausgestattet, gestaltet sich der Gewindeherstellzyklus besonders wirtschaftlich, wenn der Kühlschmierstoff durch die axiale Bohrung im Werkzeug bzw. entlang des Werkzeugschafts austritt.

Die Vorteile sind:

- Optimale Schmierung an der Werkzeugschneide
- Verbesserung der Gewindegüte
- Herausschwemmen der Späne aus der Kernlochbohrung

Hier muss darauf geachtet werden, dass der verwendete Kühlschmierstoff entsprechend gefiltert wird und das verwendete Gewindeschneidfutter für den herrschenden Kühlschmierstoff-Druck ausgelegt ist. Je nach Ausführung des Werkzeugs, mit oder ohne innerer Kühlschmierstoff-Zufuhr, sind die Schnellwechsel-Einsätze in zwei Varianten erhältlich:

Durchführung der inneren Kühlschmierstoff-Zufuhr bei Werkzeugen mit IKZ

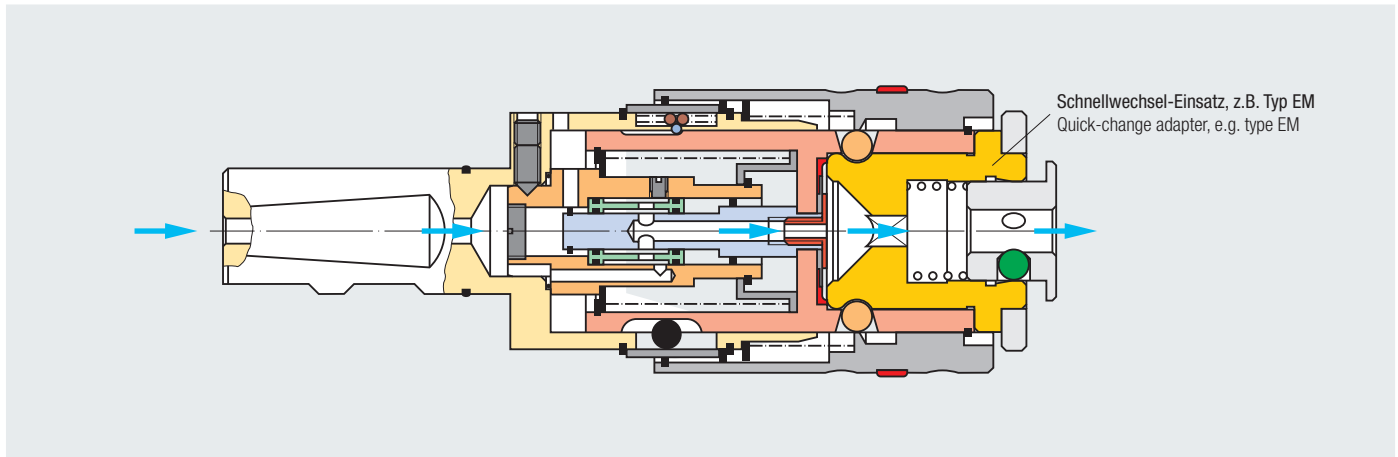

Durchführung der inneren Kühlschmierstoff-Zufuhr bei Werkzeugen ohne IKZ

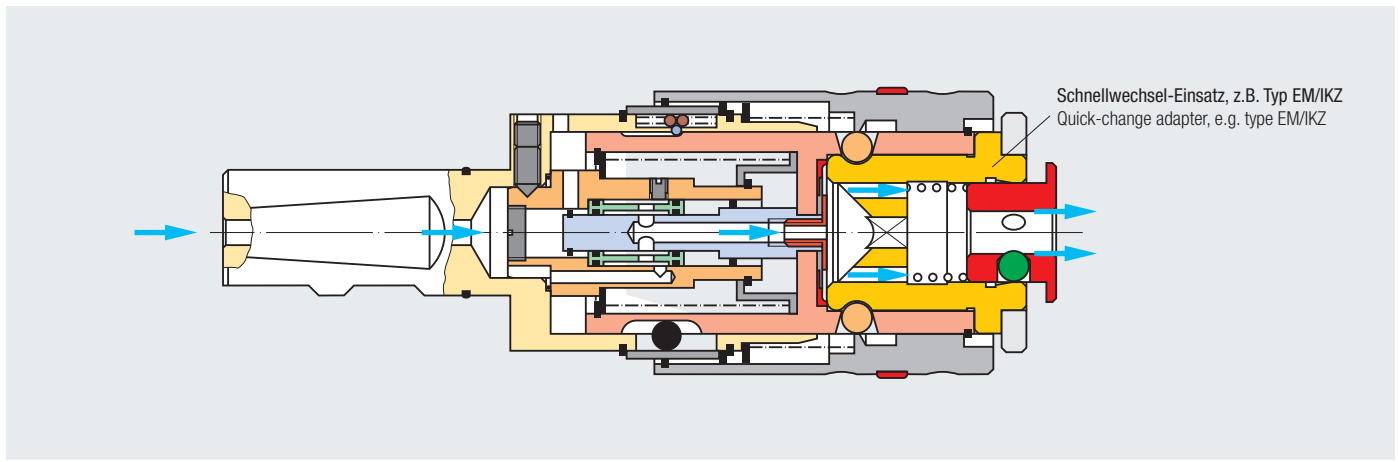

7.1 Description of the symbols for performance characteristics



Internal coolant supply (IKZ)

If a machine tool is equipped with internal coolant supply through the machine spindle, then the thread production cycle can be done with special economic efficiency by conducting the coolant-lubricant through the axial bore in the tool, or along the tool shank.

The advantages of this arrangement are:

- Perfect lubrication at the cutting edge of the tool
- Improved thread quality
- Chips are washed out of the thread hole

It is, however, necessary to make sure that the coolant-lubricant used is appropriately filtered and that the tap holder used is suitable for the coolant-lubricant pressure of the machine. Depending on the design of the tool, with or without internal coolant supply, the quick-change adapters are available in two versions:

Conduction of internal coolant supply with tools with IKZ

Conduction of internal coolant supply with tools without IKZ

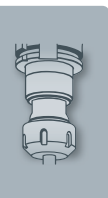

7.1 Symbolbeschreibung der Leistungsmerkmale

7.1 Description of the symbols for performance characteristics

**Minimalmengenschmierung (MMS)**

Geeignet für Maschinen, die mit einem zentralen Minimalmengenschmier-System ausgerüstet sind – man spricht auch von „Trockenbearbeitung“. Zusätzlich zu den unter IKZ beschriebenen Vorteilen kommt noch die Umweltfreundlichkeit dieser Werkzeugschmierung hinzu. Die hohen Schnittwerte können wie bei der Nassbearbeitung beibehalten werden. Außerdem werden die Kosten durch Wegfall der Beschaffung und Wartung von aufwendigen Filtereinrichtungen, sowie der Entsorgung der Emulsionen reduziert. Ausführliche Informationen siehe **7.6 Minimalmengenschmierung (MMS)**.

**Minimum-quantity lubrication (MQL)**

Suitable for machines which are equipped with a central minimum-quantity lubrication system – this is often called “dry machining”. In addition to the advantages described under “IKZ” this lubrication technology is very friendly to the environment. The high cutting data common in wet machining can be used without any change. Another advantage is the reduction of costs, since there is no need to purchase and maintain expensive filter installations, or to dispose of used emulsions. For more detailed information, see **7.6 Minimum-quantity lubrication (MQL)**.

**Minimalmengenschmierung (1-Kanal-MMS-System)**

Beim **1-Kanal-MMS-System** wird das Luft-Öl-Gemisch vor dem Eintritt in die Maschinenspindel im MMS-Gerät erzeugt und durch die Arbeitsspindel und das Spannsystem zur Wirkstelle geleitet. Ausführliche Informationen siehe **7.6 Minimalmengenschmierung (MMS)**.

**Minimum-quantity lubrication (1-channel MQL system)**

In a **1-channel MQL system**, the aerosol is generated in the MQL device before it enters into the machine spindle, and is then conducted through the work spindle and the clamping system to the point where it is needed. For more detailed information, see **7.6 Minimum-quantity lubrication (MQL)**.

**Minimalmengenschmierung (2-Kanal-MMS-System)**

Beim **2-Kanal-MMS-System** werden Öl und Luft getrennt durch die Spindel geführt, die Mischung der beiden Medien erfolgt beim Eintritt in den Werkzeughalter. Ausführliche Informationen siehe **7.6 Minimalmengenschmierung (MMS)**.

**Minimum-quantity lubrication (2-channel MQL system)**

In a **2-channel MQL system**, oil and air are conducted through the spindle separately, the mixing of the two media is done only at the point where they enter the tool holder. For more detailed information, see **7.6 Minimum-quantity lubrication (MQL)**.

p_{max} 6bar (85psi)	p_{max} 10bar (140psi)	p_{max} 50bar (700psi)	p_{max} 70bar (1015psi)	p_{max} 100bar (1400psi)
------------------------------	--------------------------------	--------------------------------	---------------------------------	----------------------------------

Kühlschmierstoff-Druck am Futtereintritt

Zur Sicherstellung der störungsfreien Funktion der Werkzeug-Aufnahme darf der angegebene Kühlschmierstoff-Druck nicht überschritten werden.

p_{max} 6bar (85psi)	p_{max} 10bar (140psi)	p_{max} 50bar (700psi)	p_{max} 70bar (1015psi)	p_{max} 100bar (1400psi)
------------------------------	--------------------------------	--------------------------------	---------------------------------	----------------------------------

Coolant-lubricant pressure at the entry to the holder

For the sake of trouble-free operation of the tool holders, it is vital not to exceed the specified maximum coolant-lubricant pressures.

Product Finder

Soft-synchro

Speed-synchro

KSN

MQL MMS

SFM

SWITCH-MASTER

GR, GR-S

HF

EM

Zubehör Accessories

Tech. Info



- Product Finder
- Soft-synchro
- Speed-synchro
- KSN
- MQL MMS
- SFM
- SWITCH-MASTER
- GR, GR-S
- HF
- EM
- Zubehör Accessories
- Tech. Info

7.1 Symbolbeschreibung der Leistungsmerkmale



Längenausgleich in Druck- und Zugrichtung

Längenausgleich in Druckrichtung

Dieser Längenausgleich kompensiert Differenzen zwischen Spindelvorschub und Steigung des herzustellenden Gewindes. Bei Verwendung eines Schnellwechsel-Einsatzes mit Überlastkupplung nimmt der Längenausgleich auf Druck beim Ansprechen der Überlastkupplung den Spindelvorschub auf.

Betätigter Längenausgleich in Druckrichtung bei

- Plusprogrammierung der Steuerung
- Überlastung des Schnellwechsel-Einsatzes mit Überlastkupplung

Activated length compensation on compression at

- Plus programming of the control
- Overload on the quick-change adapter with overload clutch

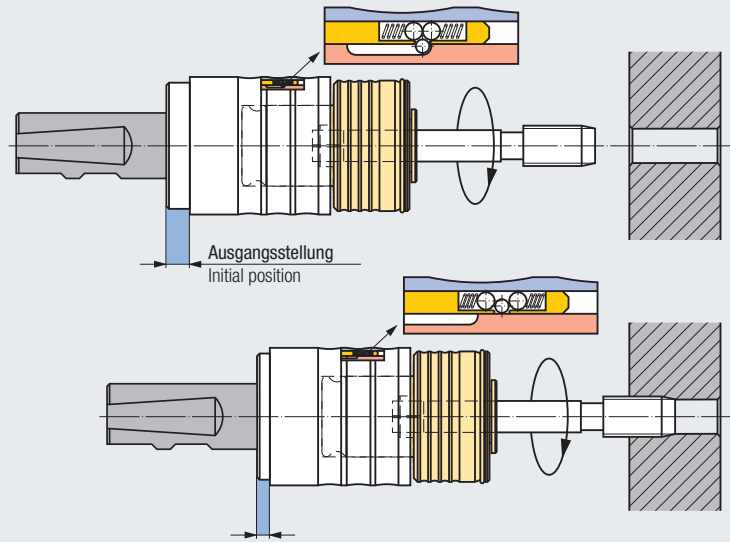

7.1 Description of the symbols for performance characteristics



Length compensation on compression and tension

Length compensation on compression

This type of length compensation compensates differences between spindle feed and the pitch of the thread to be produced. If a quick-change adapter with overload clutch is used, the length compensation on compression accommodates spindle feed as soon as the overload clutch responds.

Längenausgleich in Zugrichtung

Dieser Längenausgleich kompensiert Differenzen zwischen Spindelvorschub und Steigung des herzustellenden Gewindes, sowie ein Nachlaufen der Spindel im Umkehrpunkt des Gewindeherstellzyklus. Bei den Gewindeschneidapparaten übernimmt der Längenausgleich auf Zug die Umschaltfunktion der Drehrichtung von Rechts- auf Linkslauf.

Betätigter Längenausgleich in Zugrichtung bei

- Minusprogrammierung der Steuerung
- Manuellem Rückzug

Activated length compensation on tension at

- Minus programming of the control
- Manual retraction

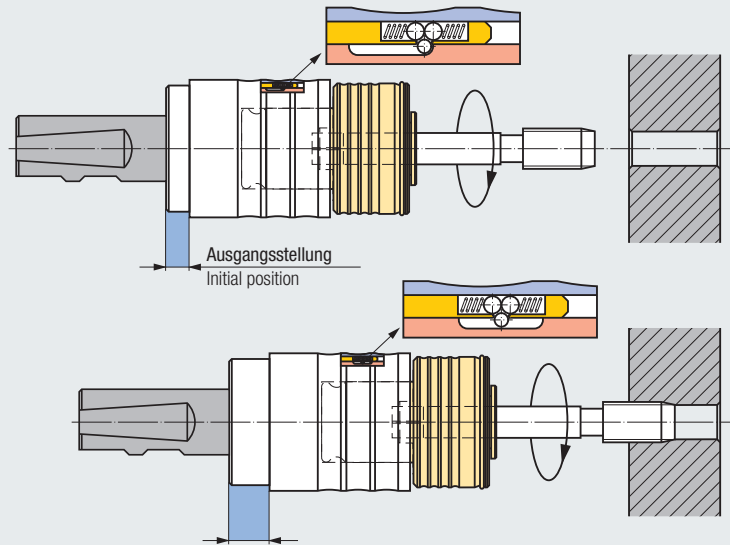

Length compensation on tension

This type of length compensation compensates differences between spindle feed and the pitch of the thread to be produced, as well as a spindle overrun at the point of reversal of the thread production cycle. With the tapping attachments, the length compensation on tension assumes the function of switching the sense of rotation from right-hand to left-hand rotation.

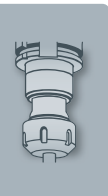

7.1 Symbolbeschreibung der Leistungsmerkmale

7.1 Description of the symbols for performance characteristics

**Minimallängenausgleich**

Durch den Einbau eines Minimallängenausgleiches in Druck- und Zugrichtung werden auftretende Minimalsteigungsdifferenzen zwischen Synchronspindel und dem Werkzeug, die zu hohen Gewindeflankenreibkräften führen würden, ausgeglichen. Eine eventuelle Axialkraftehöhung während des Gewindeherstellzyklus wird auf ein Minimum reduziert.

Die daraus resultierenden Vorteile sind:

- Kein Verschneiden der Gewinde
- Optimierte Standzeit des Werkzeugs
- Geeignet für innere Kühlschmierstoff-Zufuhr

Ausführliche Informationen siehe **7.4 Synchronre Gewindeherstellung**.

**Minimal length compensation**

An integrated minimal length compensation on compression and tension compensates minimal pitch differences between synchronous spindle and tool which would lead to excessive friction forces on the thread flanks. A possible increase of axial force during the thread production cycle is reduced to a minimum.

The resulting advantages are:

- No miscut threads
- Optimised tool life
- Suitable for internal coolant supply

For more detailed information, see **7.4 Rigid tapping**.

**Druckpunktmechanismus**

Der patentierte Druckpunktmechanismus gewährleistet ein sicheres Anschneiden des Werkzeugs. Erst wenn die effektiv auftretende Axialkraft die normal zulässige Schneidkraft übersteigt, gibt der Druckpunktmechanismus die Längenausgleichsbewegung frei. Dadurch werden reproduzierbare, gleichmäßige Gewindetiefen erreicht.

**Pressure-point mechanism**

The patented pressure-point mechanism guarantees a safe start of the thread cutting process. The length compensation movement is released by the pressure-point mechanism only when the effective axial force exceeds the normal, permissible start-of-cut force. This helps to achieve reproducible, uniform thread depths.

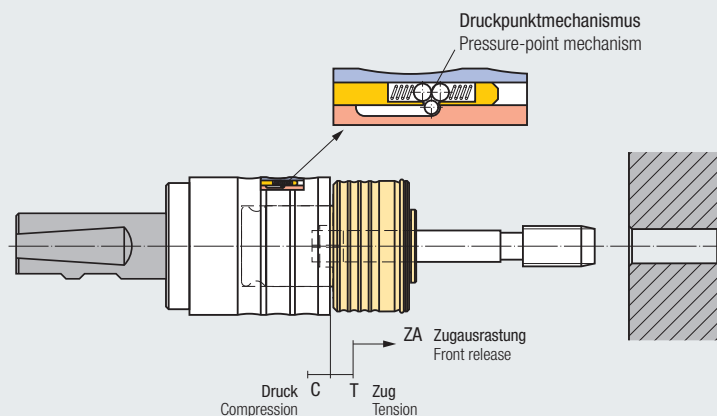

Product Finder

Soft-synchro

Speed-synchro

KSN

MQL MMS

SFM

SWITCH-MASTER

GR, GR-S

HF

EM

Zubehör Accessories

Tech. Info



- Product Finder
- Soft-synchro
- Speed-synchro
- KSN
- MQL MMS
- SFM
- SWITCH-MASTER
- GR, GR-S
- HF
- EM
- Zubehör Accessories
- Tech. Info

7.1 Symbolbeschreibung der Leistungsmerkmale



Zugausrastung

Die Zugausrastung schützt die Schnellwechsel-Aufnahme, den verwendeten Schnellwechsel-Einsatz und das Werkzeug, sowie das Werkstück vor Beschädigungen infolge übergroßer axialer Zugbelastungen. Diese Belastungen können auftreten, wenn der Längenausgleichsweg überschritten wird, weil z.B. die Maschinenspindel im Umkehrpunkt des Gewindeherstellzykluses nachläuft oder der Eilvorschub bei der Rückzugbewegung des Werkzeugs einsetzt, bevor das Werkzeug vollkommen aus dem Werkstück ausgetreten ist. In diesen Situationen rastet der Schnellwechsel-Einsatz automatisch aus der Schnellwechsel-Aufnahme aus und vermeidet kostspielige Schäden.

Stellung vor dem Auslösen der Zugausrastung Situation before the triggering of the front release

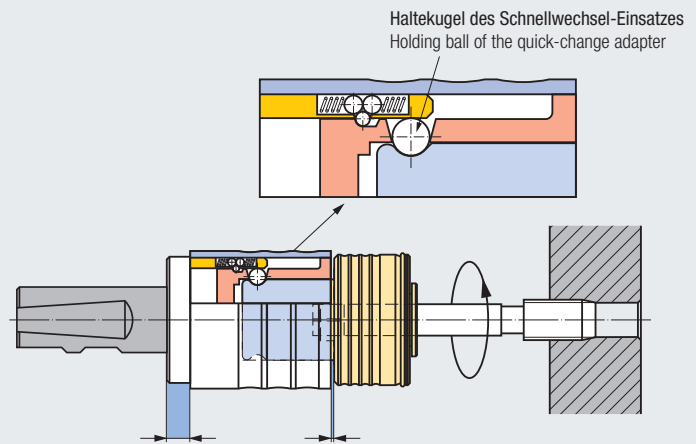

Stellung nach dem Auslösen der Zugausrastung Situation after the triggering of the front release

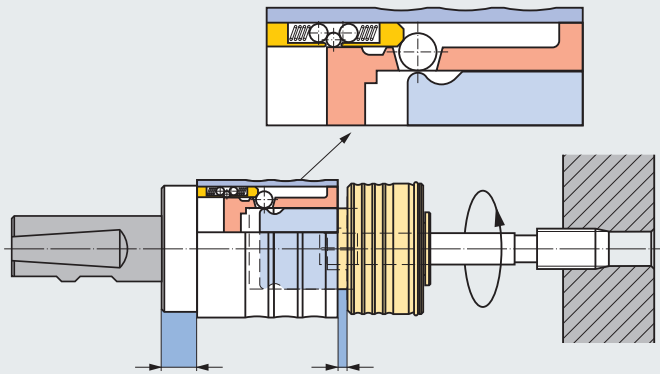

Übersetzung ins Schnelle

Durch das integrierte Übersetzungsgetriebe ins Schnelle wird die Spindeldrehzahl vervielfacht. Die Drehzahl des Gewindegewindes erhöht sich dadurch um den Übersetzungsfaktor.



Transmission gearing rapid traverse

Due to the integrated transmission gearing rapid traverse, the spindle speed is multiplied. Consequently the threading tool speed is increased by the transmission factor.

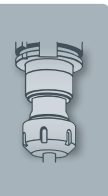

7.1 Symbolbeschreibung der Leistungsmerkmale

7.1 Description of the symbols for performance characteristics



Achspanparallele Pendelung

Ein Kugelpendelsystem stellt sicher, dass Fluchtungsfehler zwischen Maschinenspindel und Werkstückbohrung oder Rundlauffehler der Maschinenspindel ausgeglichen werden.

Zwei parallel und um 90° versetzte Bohrungen bilden eine präzise Kugel-Linearführung. Durch diese Anordnung ist die Funktion der „Parallel-Pendelung“ optimal gelöst.



Axial-parallel floating

A ball-based floating system guarantees that small errors of alignment between machine spindle and thread hole, or concentricity run-out on the side of the machine spindle, are compensated.

Two parallel drilled holes, offset by 90°, form a precise ball-based linear guide. This arrangement is the perfect solution for the function of the “parallel floating” feature.

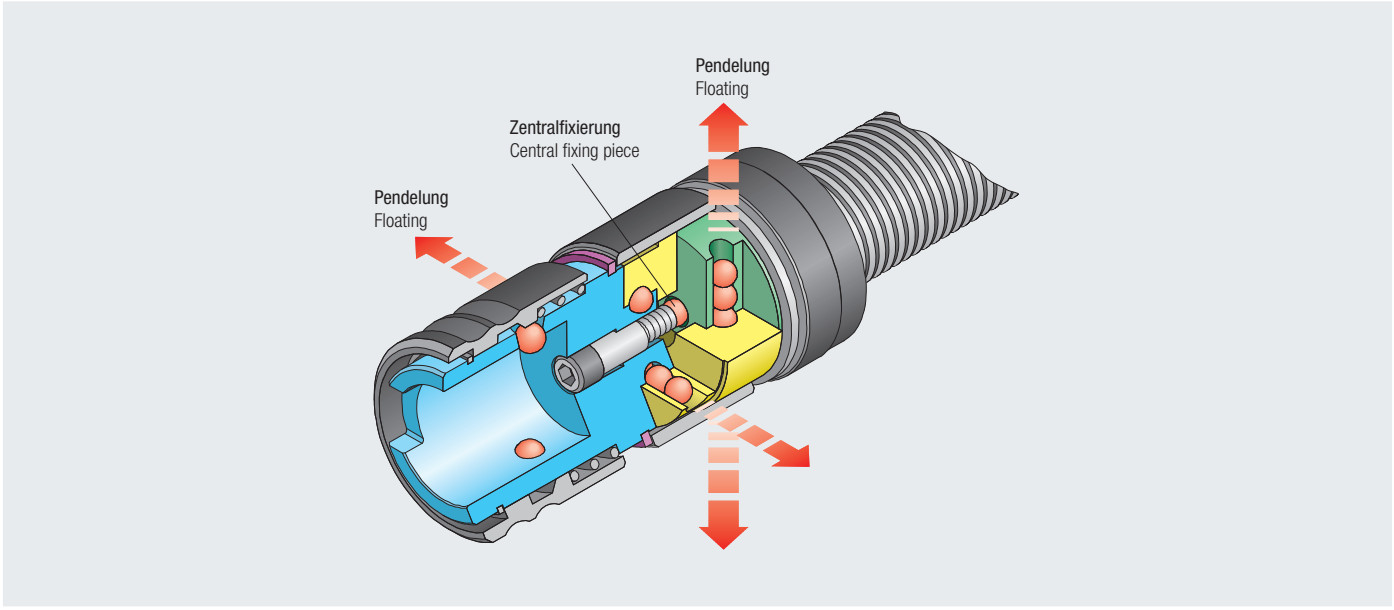

Überlastkupplung

Die von EMUGE entwickelte **Wellenprofilüberlastkupplung** zeichnet sich durch eine hohe Verschleißfestigkeit aus. Fettkammern zwischen dem oberen und unteren Kupplungsring sorgen für eine Permanschmierung während des Überlastprozesses. Beim Überschreiten des eingestellten Drehmomentes unterbricht die Überlastkupplung die Drehmomentübertragung zwischen Maschinenspindel und Werkzeug während des Gewindeherstellvorganges. Dadurch wird das Werkzeug vor Bruch geschützt.



Overload clutch

The **wave-line profile overload clutch** as developed by EMUGE is characterised by its great wear resistance. Grease chambers between the upper and lower clutch ring provide permanent lubrication during the overload process. When the set torque is exceeded during a threading process, the overload clutch immediately interrupts the torque transfer between machine spindle and tool. This protects the tap against damage.

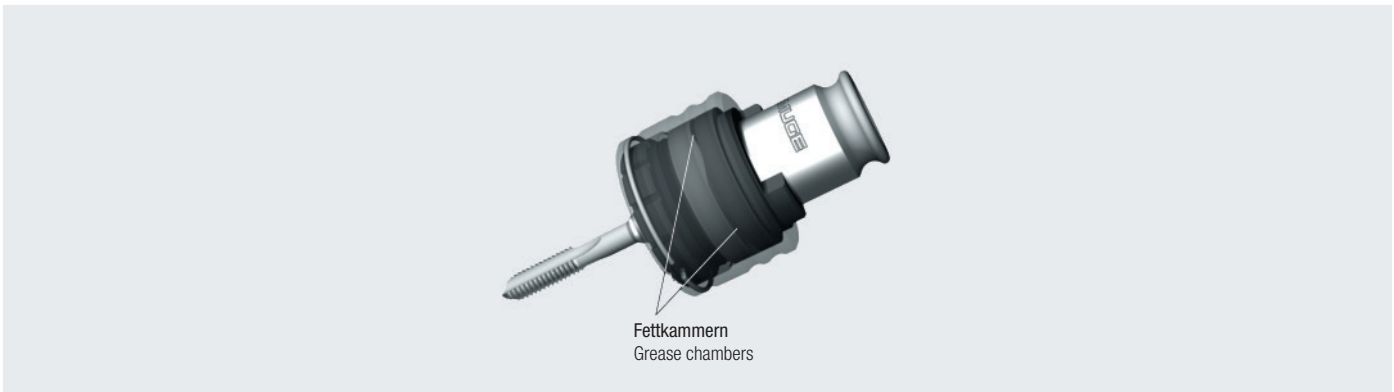

- Product Finder
- Soft-synchro
- Speed-synchro
- KSN
- MQL MMS
- SFM
- SWITCH-MASTER
- GR, GR-S
- HF
- EM
- Zubehör Accessories
- Tech. Info

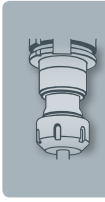

- Product Finder
- Soft-synchro
- Speed-synchro
- KSN
- MQL MMS
- SFM
- SWITCH-MASTER
- GR, GR-S
- HF
- EM
- Zubehör Accessories
- Tech. Info

7.1 Symbolbeschreibung der Leistungsmerkmale



Wendegetriebe

Durch das integrierte Wendegetriebe entfällt der Drehrichtungswechsel der Maschinenspindel beim Rücklauf.

Die daraus resultierenden Vorteile sind:

- Zeitersparnis durch kürzere Taktzeiten
- Schonung der Maschinenspindel durch konstanten Rechtslauf
- Energieeinsparung durch nahezu gleichbleibende Stromaufnahme

7.1 Description of the symbols for performance characteristics



Reverse gear

The integrated reverse gear makes a change of the sense of rotation of the machine spindle for reversing superfluous.

The resulting advantages are:

- Time savings due to reduced cycle times
- Reduced stress on the machine spindle due to constant right-hand rotation
- Energy savings due to nearly constant power consumption



Längennachstellung

Durch die Längennachstellung kann die Auskraglänge des Schnellwechsel-Einsatzes bei Bedarf nachgestellt/vergrößert werden.



Length adjustment

With the length adjustment, the projection length of the quick-change adapter can be re-adjusted or increased in case of need.



Längennachstellung von 2 mm

Die Auskraglänge des Werkzeuges kann durch die Längeneinstellschraube um 2 mm vergrößert werden.



Length adjustment by 2 mm

The projecting length of the tool can be extended by 2 mm with the length adjustment screw.



E-Lock

Arretierung des Werkzeugs mit formschlüssiger Rille am Vierkant des Werkzeugschafts. Voraussetzung für die Aufnahme des Werkzeugs in den E-Lock-Einsatz ist, dass das Werkzeug an einer Vierkantfläche mit einer Rille versehen ist. Um vorhandene Werkzeuge nachträglich mit dieser Rille versehen zu können, sind die erforderlichen Maßangaben und die dazugehörigen Prüflöhren zu verwenden. Das Ein- bzw. Auswechseln des Werkzeugs erfolgt bei herausgenommenen Einsatz aus der Schnellwechsel-Aufnahme.



E-Lock

Locking of the tool with form-positive slot on the square of the tool shank. For clamping the tool in an E-Lock adapter, it is necessary that the tool be provided with a slot on one of the flats of the square. In case existing tools have to be provided with this slot, it is necessary to use suitable dimensional specifications, and the appropriate inspection gauges. For the clamping and exchange of tools, the adapter must always be detached from the quick-change holder.

EM-E-Lock Rillenformen am Vierkant EM-E-Lock slot shapes on the driving square

Form A

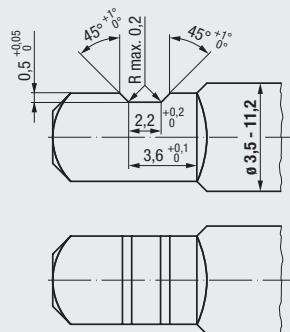

Form B

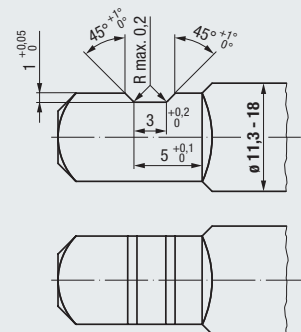

Bohren und Senken

Durch Blockieren des Längenausgleichs über eine Arretierschraube kann die Bohr- oder Senkoperation ohne Auswechseln der Schnellwechsel-Aufnahme durchgeführt werden.

Die daraus resultierenden Vorteile sind:

- Geringe Abweichung der Koaxialität zwischen Bohrung und Gewinde
- Kein zeitintensives Umrüsten mit entsprechender Kostenreduzierung



Drilling and countersinking

Drilling and countersinking operations can be done without exchanging the quick-change holder, simply by blocking the length compensation with a locking screw.

The resulting advantages are:

- Alignment offset between drilled hole and thread reduced to a minimum
- No time-consuming re-tooling, with according cost reduction

7.1 Symbolbeschreibung der Leistungsmerkmale

7.1 Description of the symbols for performance characteristics

**Werkzeugadaptierung über Schnellwechsel-Einsätze, Typenreihe EM**

Die Schnellwechsel-Einsätze der Typenreihe EM sind zum Einsatz in unseren Schnellwechsel-Aufnahmen der Typenreihe KSN und SFM bestimmt. Die fünf Größen sind in entsprechende Gewindeabmessungsbereiche eingeteilt und in verschiedenen Ausführungen lieferbar. Die Adaptierung des Werkzeugs erfolgt bei den meisten Schnellwechsel-Einsätzen über ein Schnellwechsel-Kugelspannsystem, wobei für jeden Schaftdurchmesser ein separater Einsatz erforderlich ist. Die Schnellwechsel-Einsätze sind zur Herstellung von Rechts- und Linksgewinden geeignet.

**Tool adaptation by means of quick-change adapters, EM series**

The quick-change adapters of our EM series have been designed for use in the quick-change tap holders of our KSN and SFM series. The five sizes have been divided into corresponding thread size ranges, and are available in different types. The adaptation of the tool is made by means of a quick-change ball clamping system in most quick-change adapters, with a separate adapter being necessary for each shank diameter. Our quick-change adapters are suitable for the production of right-hand and left-hand threads.

**Werkzeugadaptierung über Schnellwechsel-Einsätze, Typenreihe HE**

Die Adaptierung der Werkzeuge erfolgt über Schnellwechsel-Einsätze der Typenreihe HE. Die Klemmung des Werkzeugs erfolgt durch Gewindestifte. Für die Einsätze HE 2/IKZZ wird ein Anzugsmoment von 15 Nm empfohlen.

**Tool adaptation by means of quick-change adapters, HE series**

The tool adaptation is effected by means of quick-change adapters of our HE series. The clamping of the tool is provided by threaded pins. For our adapters type HE 2/IKZZ, we recommend a fastening torque of 15 Nm.

**Werkzeugadaptierung über Spannzangen, Typ ER (GB)**

Die Adaptierung der Werkzeuge erfolgt über Spannzangen der Typenreihe ER bzw. ER-GB (mit integriertem Vierkant) nach DIN ISO 15488 (ehemals DIN 6499). Dadurch wird eine hohe Rundlaufgenauigkeit und eine sichere Klemmung des Werkzeugs erreicht, vor allem bei hohen Schnittgeschwindigkeiten und Kühlschmierstoff-Drücken.

**Tool adaptation by means of collets, type ER (GB)**

The tool adaptation is effected by means of collets of our ER, or our ER-GB series (with integrated square) acc. DIN ISO 15488 (formerly DIN 6499). This type of clamping helps to achieve very good concentricity and a safe clamping of the tool, especially with high cutting speeds and coolant-lubricant pressures.

**Werkzeugadaptierung über Spannzangen, Typ PGR-GB**

Die Adaptierung der Werkzeuge erfolgt über Spannzangen Typ PGR-GB (mit integriertem Vierkant).

**Tool adaptation by means of collets, type PGR-GB**

The tool adaptation is effected by means of collets of type PGR-GB (with integrated square).

**Werkzeugadaptierung über Spannzangen, Typ Rubber-Flex**

Die Adaptierung der Werkzeuge erfolgt über Rubber-Flex-Spannzangen. Diese sind Gummispannzangen mit einvulkanisierten Stahlsegmenten.

**Tool adaptation by means of collets, type Rubber-Flex**

The tool adaptation is effected by means of Rubber-Flex collets. These are rubber collets with steel segments integrated by means of vulcanisation.

Product Finder

Soft-synchro

Speed-synchro

KSN

MQL MMS

SFM

SWITCH-MASTER

GR, GR-S

HF

EM

Zubehör Accessories

Tech. Info



- Product Finder
- Soft-synchro
- Speed-synchro
- KSN
- MQL MMS
- SFM
- SWITCH-MASTER
- GR, GR-S
- HF
- EM
- Zubehör Accessories
- Tech. Info

7.2 Montage von Dichtscheibe, Spannzange und Werkzeug

Montage der Dichtscheibe bei den Größen 1-5

1. Dichtscheibe wie abgebildet in die Spannmutter einsetzen, nach vorne schieben, bis ein deutliches Einrasten zu hören ist. Die Dichtscheibe ist dann bündig mit der Spannmutter.

Bei der **Größe 0** können Spannmuttern mit integriertem Dichtsystem verwendet werden – es wird keine separate Dichtscheibe benötigt. Die Spannmutter wird entsprechend dem eingesetzten Spanndurchmesser gewählt.

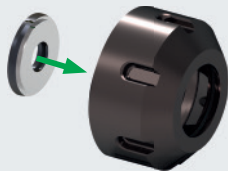

7.2 Assembly of sealing disk, collet and tool

Assembly of sealing disk in the sizes 1-5

1. Insert the sealing disk into the clamping nut as shown in the illustration, and push it forward until you can clearly hear it engaging. After that, the sealing disk is flush with the clamping nut.

In **size 0**, you can use clamping nuts with integrated sealing system – a separate sealing disk is not needed then. The clamping nut must be selected in accordance with the clamping diameter used.



2. Spannzange in die Spannmutter einschieben, anschließend kippen. Nut der Spannzange an der markierten Stelle in den Exzenterring der Spannmutter einrasten.

Spannzange in entgegengesetzte Richtung kippen, bis diese deutlich hörbar einrastet.

2. Insert the collet into the clamping nut, then tilt it. The groove of the collet must engage in the eccentric ring of the clamping nut at the marked position. Now, tilt the collet in the opposite direction until you clearly hear it engaging.

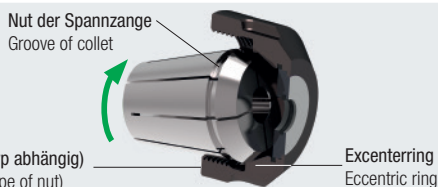

3. Spannmutter mit der eingerasteten Spannzange auf das Gewinde der Spannzangen-Aufnahme schrauben.

Wichtig: Nur Spannmuttern mit richtig eingerasteter Spannzange montieren!

3. Screw the clamping nut with the engaged collet onto the thread of the holder.

Important: Only screw on clamping nuts with correctly engaged collet!



4. Werkzeug einschieben. **Wichtig:** Wird eine Spannzange mit integriertem Vierkant verwendet, muss das Werkzeug durch drehen in die Position gebracht werden, dass es in das Vierkant der Spannzange geschoben werden kann.

4. Insert tool. **Important:** If you use a collet with integrated square, make sure to turn the tool around until it is in a position that allows it to be pushed into the square seat of the collet.

5. Spannmutter mit Schlüssel festziehen. Hierbei sind die empf. Anzugsdrehmomente aus der Tabelle zu beachten.

5. Tighten the clamping nut with the wrench. Observe the rec. torque values in the table.

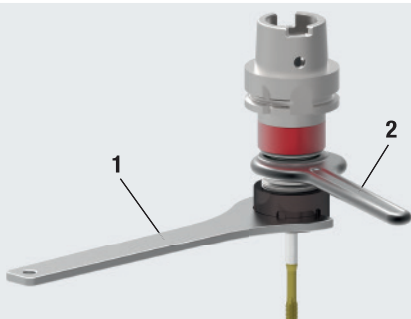

Typ Type	Empf. Anzugsdrehmoment Rec. tightening torque (Nm)
Hi-Q/ERM 8	6
Hi-Q/ERM 11	12
Hi-Q/ER 11	14
Hi-Q/ER 50	300
Hi-Q/ERMC 11	12
Hi-Q/ERMC 16	24
Hi-Q/ERMC 20	28
Hi-Q/ERMC 25	32

Typ Type	Empf. Anzugsdrehmoment Rec. tightening torque (Nm)
Hi-Q/ERC 11	14
Hi-Q/ERC 16	40
Hi-Q/ERC 20	32
Hi-Q/ERC 25	80
Hi-Q/ERC 32	90
Hi-Q/ERC 40	180
Hi-Q/ERBC 50 AF	300

Angaben gelten bei Verwendung von Spannzangen Typ ER-GB. Das maximale Anzugsdrehmoment darf nicht mehr als 25% über den empfohlenen Werten liegen. Bei höheren Anzugsdrehmomenten können an der Spannzangenaufnahme bleibende Deformationen auftreten. Um das korrekte Drehmoment einstellen zu können, empfehlen wir die Verwendung eines Drehmomentschlüssels, siehe Seite 795.

The indicated values apply to collets type ER-GB. The maximum tightening torque must not be more than 25% above the recommended tightening torque. Higher tightening torque may result in the damage of the collet. For the setting of the correct torque, we recommend using a torque wrench, see page 795.

Wichtig: Um die Spannzangenaufnahme nicht zu beschädigen, muss beim Anziehen der Spannmutter mittels Schlüssel 1 mit dem Gabelschlüssel 2 gegengehalten werden. Passende Werkzeugsets finden Sie auf Seite 793 - 794.

Important: In order to avoid damage to the holder, please counter with open-ended spanner 2 while tightening the clamping nut with wrench 1. For suitable tool sets, see pages 793 - 794.

7.3 Übersicht der Kegel-Hohlschäfte mit Plananlage (HSK)**7.3 Overview of hollow taper shanks with flange contact surface (HSK)****DIN 69893-1, ISO 12164-1****Form A**

- Standardausführung für Bearbeitungszentren
- Für automatischen Werkzeugwechsel mit Greif- und Indexiernut
- Zentrale Kühlschmierstoff-Zufuhr über Kühlschmierstoffrohr
- Mitnehmernuten am Kegelumlauf
- Bohrung für Datenträger (DIN 69873)
- Auch als Form C verwendbar, da Spanneinleitungsbohrung vorhanden

Form A

- Standard design for machining centres
- For automatic tool change with gripper and indexing groove
- Central coolant supply by way of coolant tube
- Drive-key slots at the end of the taper
- Bore for data chip (DIN 69873)
- Useable as Form C also, since clamping activation bore is included

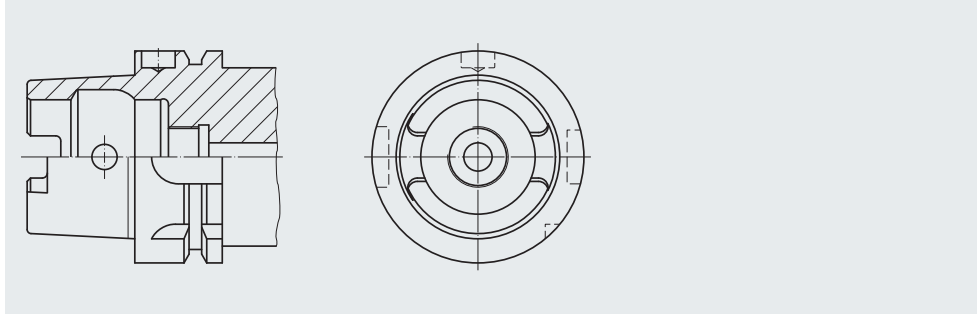
**Form C**

- Für Sondermaschinen und modulare Werkzeugsysteme
- Für manuellen Werkzeugwechsel
- Zentrale Kühlschmierstoff-Zufuhr
- Mitnehmernuten am Kegelumlauf

Form C

- For special machines and modular tool systems
- For manual tool change
- Central coolant supply
- Drive-key slots at the end of the taper

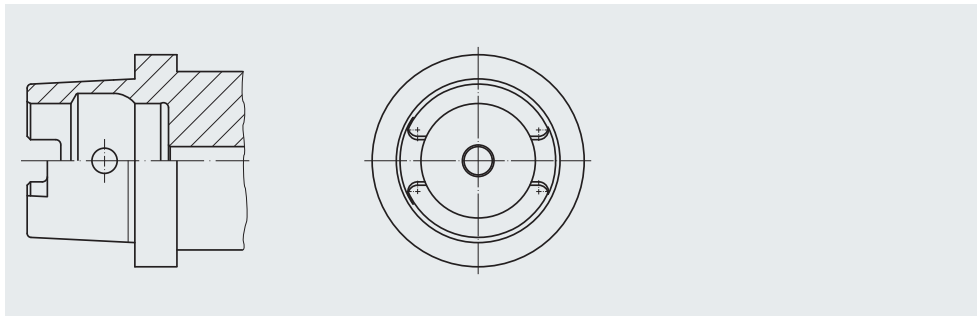
**ISO 12164-2****Form T**

- Für Dreh- und Fräsmaschinen
- Für automatischen Werkzeugwechsel
- Zentrale Kühlschmierstoff-Zufuhr über Kühlschmierstoffrohr
- Eingeeigte Mitnehmernuten
- Bohrung für Datenträger (DIN 69873)
- Auch als Form C verwendbar, da Spanneinleitungsbohrung vorhanden

Form T

- For turning and milling machines
- For automatic tool change
- Central coolant supply by way of coolant tube
- Modified drive-key slots
- Bore for data chip (DIN 69873)
- Useable as Form C also, since clamping activation bore is included

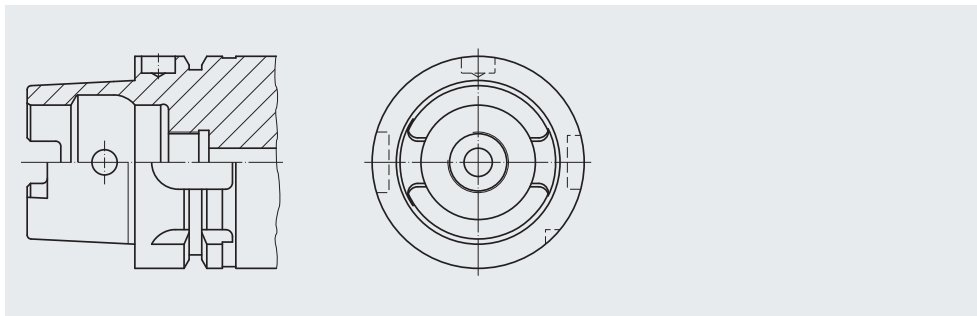

Product Finder

Soft-synchro

Speed-synchro

KSN

MQL MMS

SFM

SWITCH-MASTER

GR, GR-S

HF

EM

Zubehör Accessories

Tech. Info



- Product Finder
- Soft-synchro
- Speed-synchro
- KSN
- MQL MMS
- SFM
- SWITCH-MASTER
- GR, GR-S
- HF
- EM
- Zubehör Accessories
- Tech. Info

7.4 Synchrone Gewindeherstellung

Warum synchrone Gewindeherstellung mit starren Spannzangen-Aufnahmen nicht zu optimalen Werkzeugstandzeiten führt.

Bei der Herstellung eines Gewindes auf einer CNC-Maschine mit Gewindebohrern oder -formern (nachfolgend zur Vereinfachung mit Gewindewerkzeug bezeichnet) muss die Geschwindigkeit der Drehbewegung der Maschinenspindel mit der Geschwindigkeit der Vorschubachse erfasst, verrechnet und synchronisiert werden.

Bei der Verrechnung der Gewindesteigung und der Schnittgeschwindigkeit, aus der sich die Vorschubgeschwindigkeit ableitet, entstehen Fehler durch Parameter, die bei der Regelung nicht berücksichtigt werden können.

Zu erwähnen sind hier die zwei Haupteinflussgrößen:

1. Einflussgrößen durch das CNC-Bearbeitungszentrum

Rechnergeschwindigkeit, Auflösung der Achsensensorik (lineare Achse, Drehachse, C-Achse), mechanischer Zustand der Maschine.

2. Einflussgrößen durch das Gewindewerkzeug

- a) Toleranzen der Gewindesteigung nach DIN EN 22857
- b) Temperaturgang der Gewindesteigung, Längenausdehnung des Gewindewerkzeugs bei $t_{\text{Arbeit}} \neq t_{\text{Messen}}$

1. Einflussgrößen durch das CNC-Bearbeitungszentrum

Das Schneiden und Formen von Gewinden mit Synchronspindeln erfordert wegen des Formschlusses zwischen Werkzeug und Werkstück ein ständiges μ -genaues Überwachen und Regeln der Vorschubachsenbewegung in Relation zur Drehbewegung der Werkzeugspindel.

Damit unterscheidet sich die Gewindeherstellung von sonst bekannten Bearbeitungen wie z.B. Bohren, Reiben oder Fräsen. Bei diesen Bearbeitungen wird von der Steuerung lediglich eine exakte Linearbewegung zur Positionierung gefordert, da diese Werkzeuge nicht formschlüssig mit dem Werkstück verbunden sind. Dies hat zur Folge, dass das Hauptaugenmerk der Maschinenhersteller auf der Kontrolle der Linearachsen liegt. In der Praxis werden heute zur Regelung der Rotationsachse lediglich Rotgeber mit 256 Impulsen pro Spindelumdrehung (360°) eingesetzt. Dies entspricht einem Winkel und somit Überwachungsloch von 1,4° pro Impuls.

- Es entstehen Axialkräfte bei der Gewindebearbeitung durch Regelungsfehler oder Regelungsungenauigkeiten.

Beispiel:

Gewindewerkzeug M10

Gewindesteigung 1,5 mm

Mögliche unkontrollierte Spindeldrehung 1,4°

- Möglicher axialer Positionsfehler von ca. 5,8 μm zwischen Gewindewerkzeug-Sollposition und Maschinenspindel-Istposition

7.4 Rigid tapping

Why synchronous thread production with rigid collet holders will not result in optimum tool lives.

When producing a thread on a CNC machine with taps or cold-forming taps (for simplicity's sake, we will call them threading tools in the following) the speed of the rotation movement of the machine spindle with the speed of the feed axis must be registered, accounted and synchronised.

When accounting the threading tool pitch and the cutting speed – giving the feed speed, faults may occur caused by parameters not being considered during the control.

Two main influencing variables are:

1. Influencing factors by the CNC machining centre

Computer speed, resolution of the axis detection (linear axis, turning axis, C-axis), mechanical condition of the machine.

2. Influencing factors by the threading tool

- a) Tolerances of the thread pitch acc. to DIN EN 22857
- b) Change of thread pitch and length of the threading tool when $t_{\text{Work}} \neq t_{\text{Measurement}}$

1. Influencing factors by the CNC machining centre

Regarding the formfitting between tool and workpiece, the cutting and forming of threads with synchronous spindles requires permanent μ -exact control and adjusting of the feed axis movement in relation to the rotation movement of the tool spindle. Thus the thread production differs from other known kinds of machining eg drilling, reaming or milling. These processings only require an exact linear movement of the control for positioning purposes, as these tools are not connected formfitting with the workpiece. Consequently, the main emphasis of machine manufacturers is on the control of the linear axis. In practice today simply rotary pick-ups with 256 impulses per spindle rotation (360°) are used to control the rotation axis. This corresponds to an angle and so a control gap of 1.4° per impulse.

- Axial forces during thread machining arise caused by control faults or control inaccuracies.

Example:

Tap M10

Thread pitch 1.5 mm

Possible uncontrolled spindle rotation 1.4°

- Possible axial position fault of about 5.8 μm between threading tool specified position and machine spindle real position.

Diagramm Maschinenspindelrehpositionsfehler / axiale Steigungsfehler (gewindesteigungsabhängig)

Auswirkung des Fehlers der Maschinendrehbewegung auf das Gewindewerkzeug

Graph machine spindle turning position fault / axial pitch fault (depends on thread pitch)

Effect of machine turning movement fault on the tool

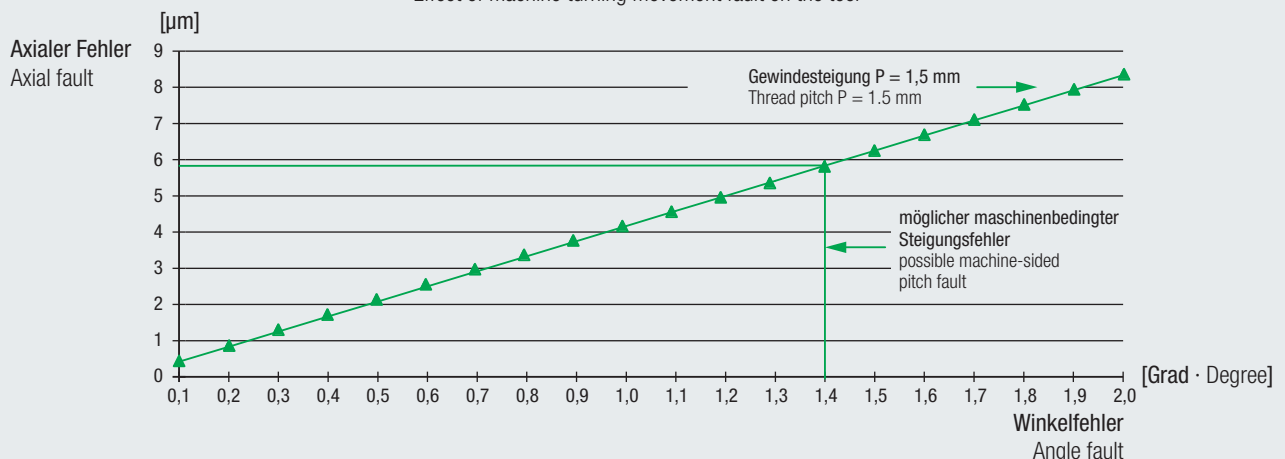

7.4 Synchrone Gewindeherstellung

7.4 Rigid tapping

Hinzu kommt, dass die Rechnergeschwindigkeit moderner CNC-Bearbeitungsmaschinen nicht ausreicht, um eine höhere Anzahl von Impulsen des Rotgebers im Bereich von $n = 0$ bis zur max. Spindeldrehzahl zu verarbeiten und die zu synchronisierenden Achsen einzuregeln. Am Beispiel eines CNC-Bearbeitungszentrums mit 256 Impulsen pro Spindelumdrehung kann man aufzeigen, dass die Axialkraft, die auf die Gewindegewindewerkzeugflanken wirkt, mit zunehmender Schnittgeschwindigkeit ansteigt. Die folgenden Diagramme zeigen, dass die Axialkraft für das Formen eines Gewindes M10 bei 500 min^{-1} (ca. $15,7 \text{ m/min}$) bei ca. 1900 N liegt und mit einer Steigerung der Drehzahl auf 2000 min^{-1} ($62,8 \text{ m/min}$) bei über 2500 N . Dadurch ist deutlich zu erkennen, dass die entstehende Axialkraft, verursacht durch Synchronisierungsfehler, drehzahlabhängig ist.

Additionally, the computer speed of modern CNC machining centers is not sufficient to handle a higher number of impulses of the rotary pick-up in the range of $n = 0$ up to the max. spindle speed and to adjust the axis to be synchronised. The example of a CNC machining center with 256 impulses per spindle rotation shows that the axial force working on the tool flanks, increases with growing cutting speed. The following graphs show that the axial force for forming an M10 thread with 500 rpm (about 15.7 m/min) is at about 1900 N ; with an increase of the speed to 2000 rpm (about 62.8 m/min) at over 2500 N . This clearly shows that the arising axial force, caused by the synchronisation fault, depends on the speed.

Drehzahl 500 min^{-1} Gewindeformer M10 in C45
Speed 500 rpm Cold-forming tap M10 in C45

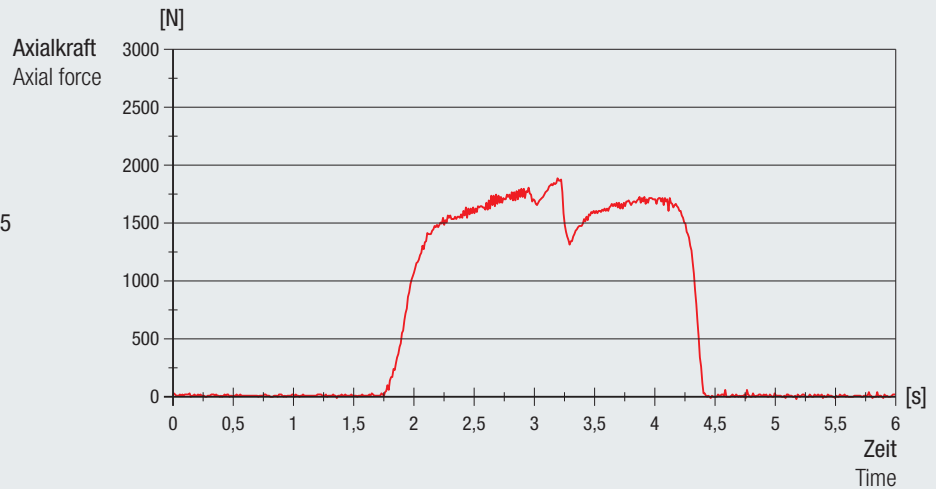

Drehzahl 2000 min^{-1} Gewindeformer M10 in C45
Speed 2000 rpm Cold-forming tap M10 in C45

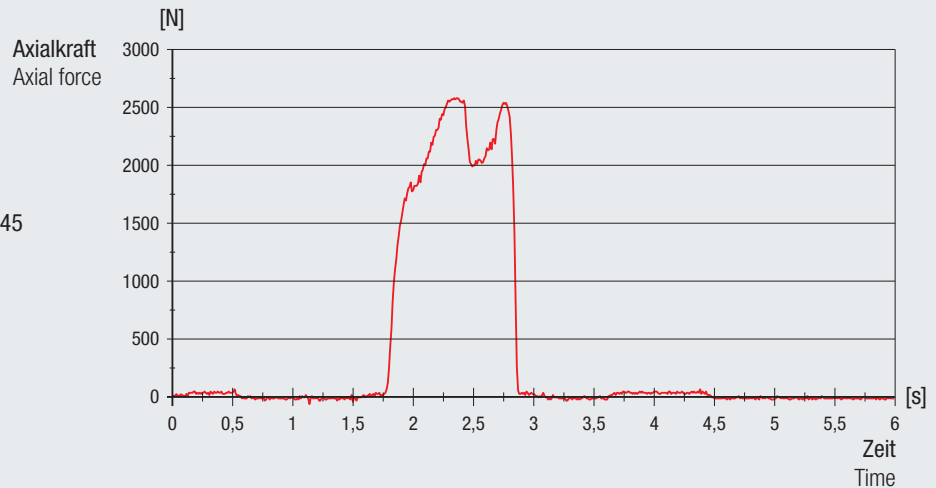

- Product Finder
- Soft-synchro
- Speed-synchro
- KSN
- MQL MMS
- SFM
- SWITCH-MASTER
- GR, GR-S
- HF
- EM
- Zubehör Accessories
- Tech. Info**

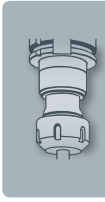

- Product Finder
- Soft-synchro
- Speed-synchro
- KSN
- ML MMS
- SFM
- SWITCH-MASTER
- GR, GR-S
- HF
- EM
- Zubehör Accessories
- Tech. Info

7.4 Synchrone Gewindeherstellung

7.4 Rigid tapping

2. Einflussgrößen durch das Gewindewerkzeug

a) Toleranzen der Gewindesteigung

Für Gewindewerkzeuge sind in der europäischen Norm DIN EN 22857 die Abmessungen und Toleranzen für geschliffene Gewinde festgelegt.

Aus der Norm ist zu entnehmen, dass für die Gewindewerkzeugtoleranz eine kleinste Abweichung von $\pm 8 \mu\text{m}$, bezogen auf eine definierte Anzahl von Gewindegängen, zugelassen ist.

Beispiel:

Gewindewerkzeug M10

Gewindesteigung 1,5 mm

Prüflänge 7 Gänge

► Zulässige Steigungstoleranz $\pm 8 \mu\text{m}$

2. Influencing factors by the threading tool

a) Tolerances of the thread pitch

For threading tools the European standard DIN EN 22857 defines the dimensions and tolerances for ground threads. Extract from the standard DIN EN 22857

For the tool tolerance the standard allows a smallest deviation of $\pm 8 \mu\text{m}$ referred to a defined number of threads.

Example:

Tap M10

Thread pitch 1.5 mm

Check length 7 threads

► Allowed pitch tolerance $\pm 8 \mu\text{m}$

Kraft/Weg-Diagramm

Benötigte Kraft für die Längenänderung eines Gewindewerkzeugs mit Schaftdurchmesser 10 mm

Force/Movement graph

Required force for the length change of threading tool with shank diameter 10 mm

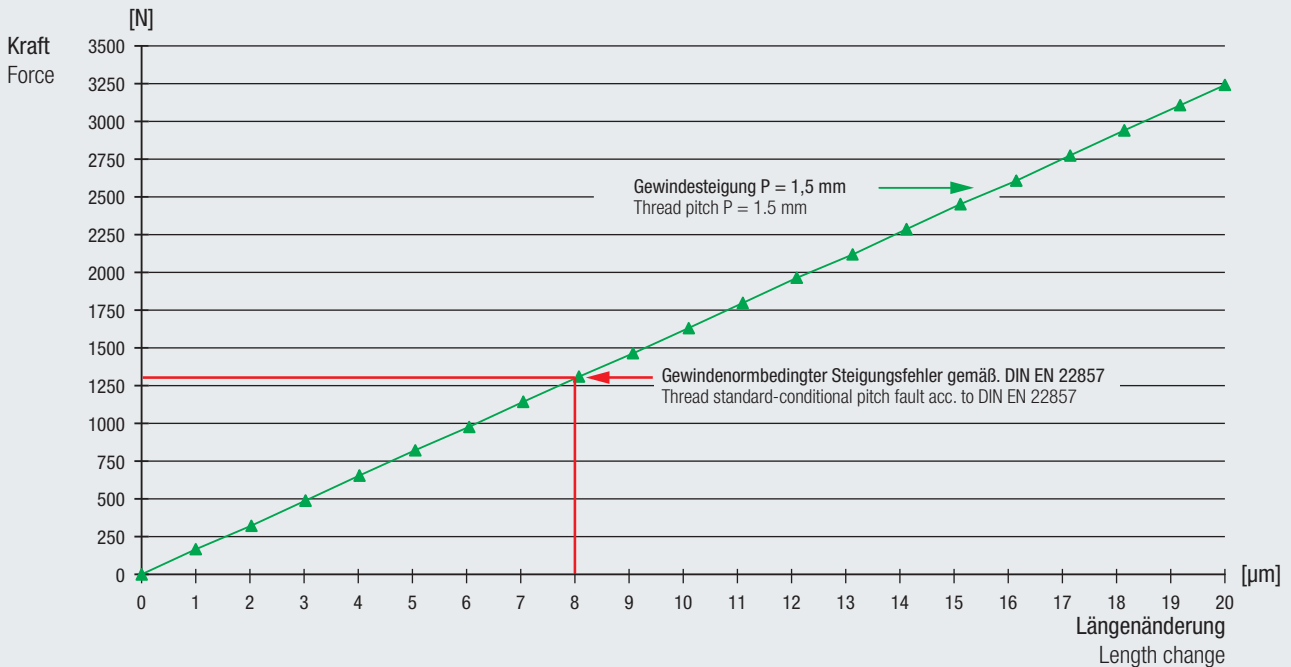

b) Temperaturgang der Gewindesteigung, Längenausdehnung des Gewindewerkzeugs bei $t_{\text{Arbeit}} \neq t_{\text{Messen}}$

Jede von der Messtemperatur 20°C abweichende Werkzeugtemperatur führt zu einer Längenänderung. Bezogen auf ein Gewindewerkzeug M10 mit 100 mm Länge ergibt sich bei einer Temperaturänderung von 20°C auf z.B. 40°C eine Längenänderung von $32 \mu\text{m}$.

Bezogen auf die Prüflänge von 7 Gang gemäß DIN EN 22857 ergibt sich folgendes **Beispiel**:

Gewindewerkzeug M10

Gewindesteigung 1,5 mm

Gewindewerkzeuglänge 100 mm

Prüflänge 7 Gänge = 10,5 mm

► Axiales Wachsen des Werkzeugs und somit der Gewindesteigung von $3,4 \mu\text{m}$

b) Change of thread pitch and length of the threading tool when $t_{\text{Work}} \neq t_{\text{Measurement}}$

Each tool temperature – differing from the measuring temperature 20°C – causes a change in length. For an M10 tap with 100 mm length the temperature change from 20°C to eg 40°C causes length change of $32 \mu\text{m}$.

Considering a check length of 7 threads acc. to standard DIN EN 22857 the following **example** results:

Tap M10

Thread pitch 1.5 mm

Tap length 100 mm

Check length 7 threads = 10.5

► Axial growth of the tool and thread pitch of $3,4 \mu\text{m}$

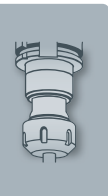

7.4 Synchrone Gewindeherstellung

7.4 Rigid tapping

- Product Finder
- Soft-synchro
- Speed-synchro
- KSN
- MQL MMS
- SFM
- SWITCH-MASTER
- GR, GR-S
- HF
- EM
- Zubehör Accessories
- Tech. Info

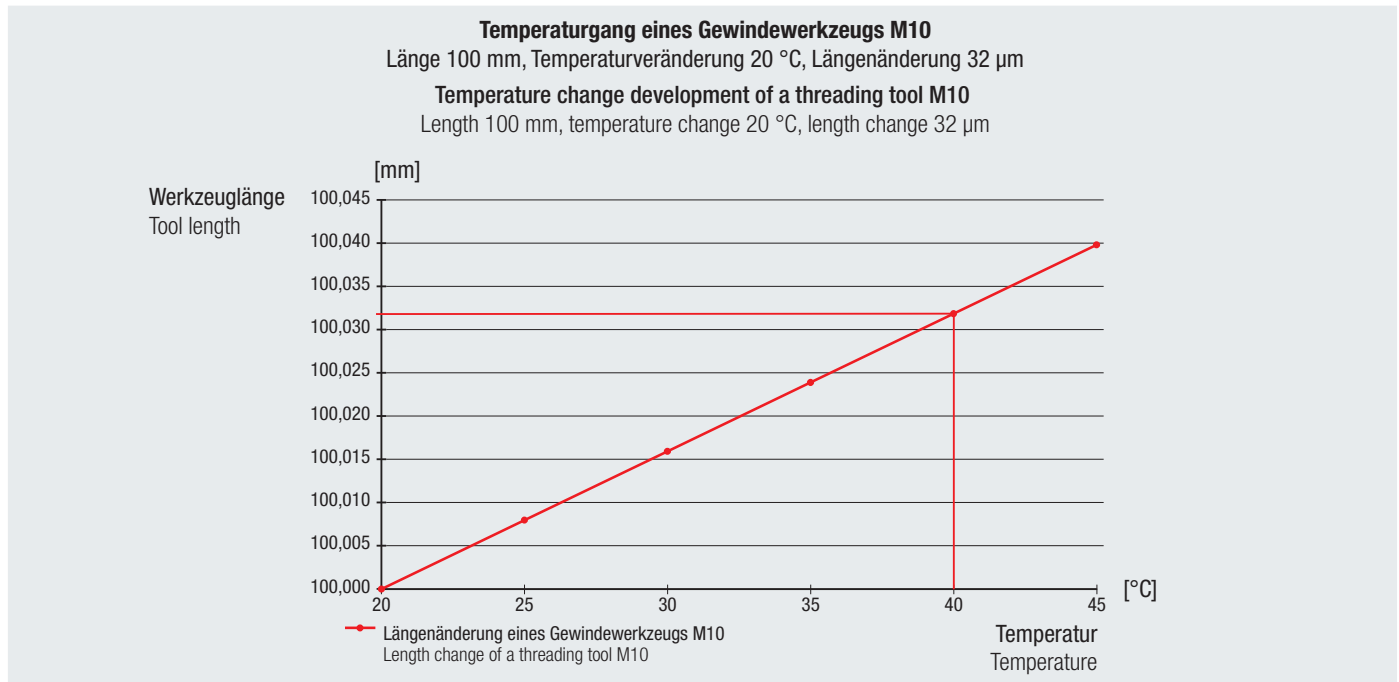

Bezogen auf eine Prüflänge von 7 Gang gemäß DIN EN 22857 ergibt sich bei einer Gewindesteigung von 1,5 mm eine **axiale Längenänderung von 3,4 µm**.

Referred to a check length of 7 threads acc. to DIN EN 22857 and a pitch of 1.5 mm the **axial length would change by 3.4 µm**.

Der Nachweis einer Temperaturänderung des Gewindewerkzeugs kann durch die Messung der Temperatur an der während der Gewindeherstellung meist belasteten Spanfläche erfolgen. Im folgenden Diagramm ist die Temperatur der Spanfläche für ein Gewindewerkzeug M10 bei verschiedenen Schnittgeschwindigkeiten aufgetragen. Als Werkstoff wurde C45, als Kühlschmierstoff 5%ige Emulsion verwendet.

The proof of a change in temperature of the threading tool can be given by measuring the cutting face being heaviest used during the thread production. The following graph shows the temperature of the cutting face for a threading tool M10 with various cutting speeds. Material used is C45, coolant-lubricant is 5% emulsion.

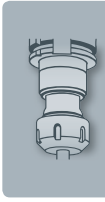
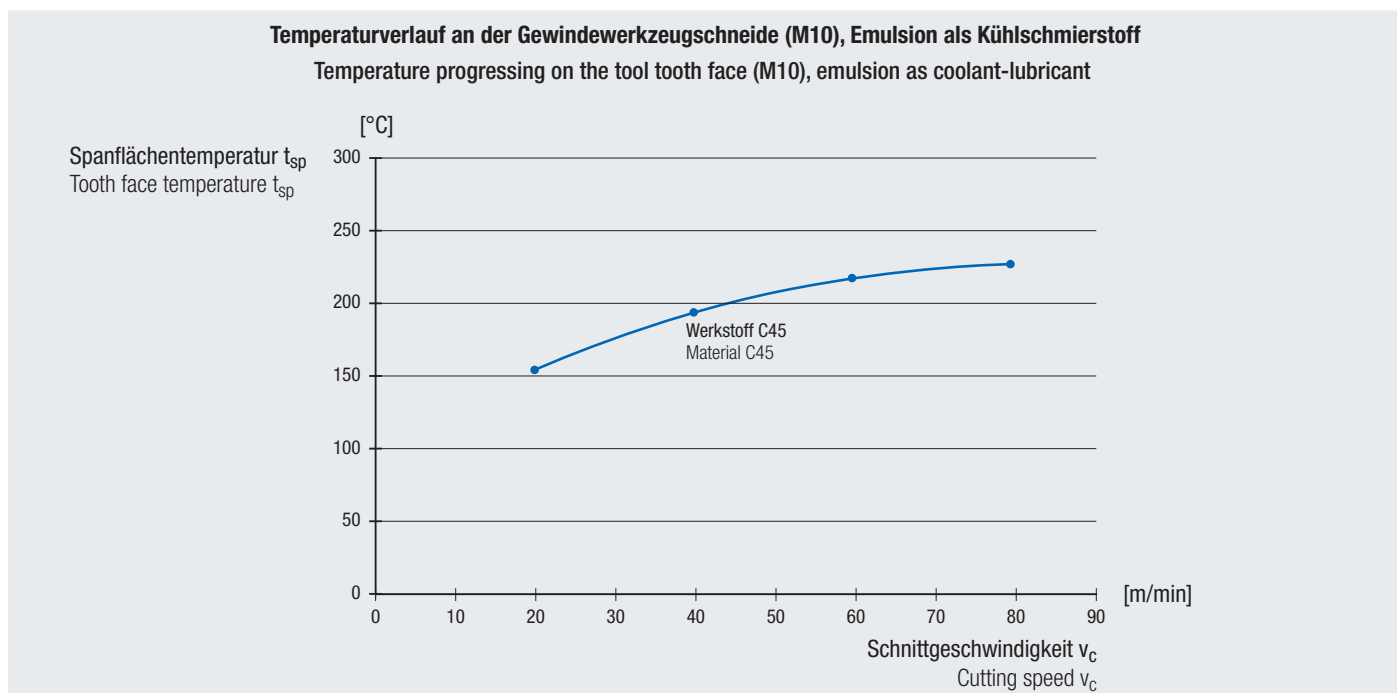

- Product Finder
- Soft-synchro
- Speed-synchro
- KSN
- MQL MMS
- SFM
- SWITCH-MASTER
- GR, GR-S
- HF
- EM
- Zubehör Accessories
- Tech. Info

7.4 Synchrone Gewindeherstellung

Zusammenfassung

Um die gesamte Auswirkung der einzelnen Einflussfaktoren, die hier angesprochen wurden, auf die Axialkraftkomponente des Gewindeherstellungsprozesses zu erkennen, müssen die aufgeführten möglichen Positionsfehler, Längenänderungen bzw. Kräfte, die zu Längenänderungen führen, zusammengefasst werden.

Das folgende **Diagramm** zeigt auf:

- Bei einer Addition der möglichen Axialfehler durch maschinen-, steigungstoleranz- und temperaturbedingte Einflussgrößen kann im ungünstigsten Fall ein Positionsfehler zwischen Soll-Position des Gewindewerkzeugs und Ist-Position der Maschinenspindel von über 17 µm entstehen,
- **Dieser Positionsfehler führt zu einer Axialkraft von ca. 2800 N** in dem hier gezeigten Beispiel mit einem Gewindewerkzeug M10,
- Diese Kraft wird von den Gewindeflanken des Gewindewerkzeugs aufgenommen, was erhöhte Flankenreibung und dadurch erhöhten Werkzeugverschleiß zur Folge hat.

7.4 Rigid tapping

Summary

To realise the total effect of the individual influencing factors mentioned before on the axial force component of the thread producing process, the shown possible position faults, length changes resp. the forces causing length changes must be combined.

The following **graph** shows:

- With an addition of possible axial faults caused by machine pitch tolerance or temperature influencing factors a position fault between specified position of the tap and real position of the machine spindle of more than 17 µm may arise
- **This position fault results in an axial force of about 2800 N** in the shown example with a threading tool M10.
- This force is taken up by the flanks of the tool resulting in increasing flank friction and increased tool wear.

Kraft/Weg-Diagramm
Benötigte Kraft für die Längenänderung eines Gewindewerkzeugs mit Schaftdurchmesser 10 mm
Force/Movement graph
Required force for the length change of threading tool with shank diameter 10 mm

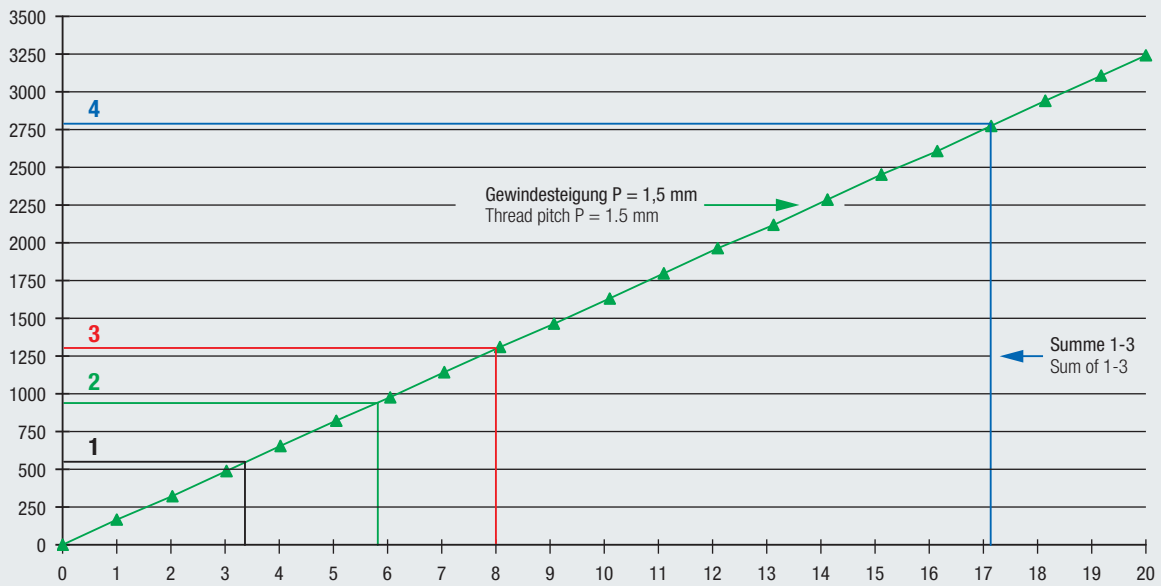

- 1** Möglicher temperaturbedingter Steigungsfehler
Possible temperature-caused pitch fault
- 2** Möglicher maschinenbedingter Steigungsfehler
Possible machine-caused pitch fault
- 3** Möglicher norm-, bzw. gewindewerkzeugbedingter Steigungsfehler
Possible standard resp. threading tool caused pitch fault
- 4** Mögliche Axialkraft auf die Werkzeugflanken
Possible axial force on the tool flanks

Diese zugegebenermaßen theoretischen Betrachtungen der Vorgänge bei der Herstellung eines Gewindes lassen sich jedoch praktisch belegen.

These perhaps theoretical reflections of the processes during production of a thread can be proven in practice.

7.4 Synchrone Gewindeherstellung

Als **Beispiel** wird ein Gewinde M10 mit drei unterschiedlichen Werkzeughaltern in den Werkstoff C45 geformt. Die Axialkräfte wurden dabei bei zwei Drehzahlen, $500 \text{ min}^{-1} = 15,7 \text{ m/min}$ und $2000 \text{ min}^{-1} = 62,8 \text{ m/min}$, aufgezeichnet. Folgende Spannzangen-Aufnahmen wurden getestet:

- Starre Synchron-Spannzangen-Aufnahme,
- EMUGE Spannzangen-Aufnahme Softsynchro® der Größe 1 mit Minimallängenausgleich auf Druck und Zug,
- Synchron-Spannzangen-Aufnahme eines Wettbewerbers mit Minimallängenausgleich mit axialer Dämpfung

Bei allen getesteten Spannzangen-Aufnahmen wurde eine Spannzange Typ ER20-GB, also mit integriertem Vierkant, verwendet.

7.4 Rigid tapping

As an **example** an M10 thread with three different tool holders is formed in material C45. The axial forces were recorded at two speeds which were $500 \text{ rpm} = 15.7 \text{ m/min}$ and $2000 \text{ rpm} = 62.8 \text{ m/min}$. The following collet adaptations have been tested:

- Rigid synchronous collet adaptation
- EMUGE collet adaptation Softsynchro® size 1 with minimum length compensation on compression and tension
- Synchronous collet adaptation of a competitor with minimum length compensation with axial damping

With all tested collet adaptations a collet type ER20-GB with integrated square was used.

Drehzahl 500 min^{-1} Gewindeformer M10 in C45
Speed 500 rpm Cold-forming tap M10 in C45

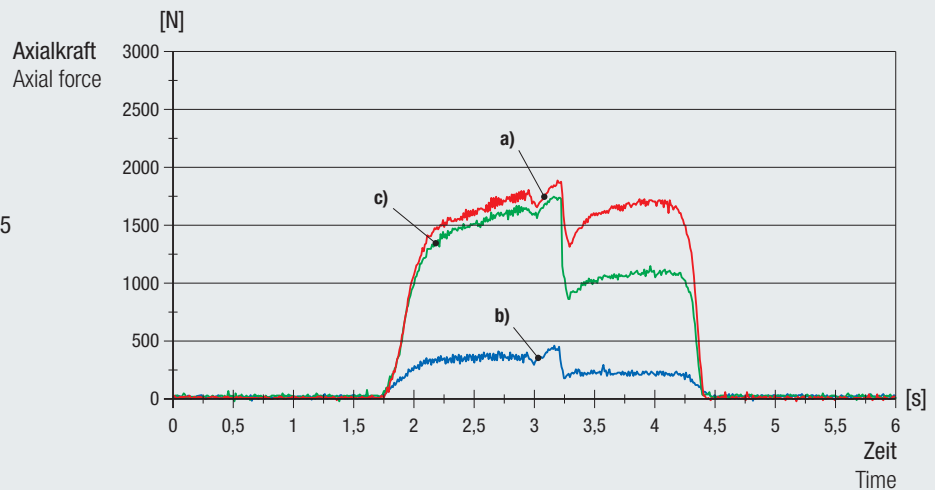

Drehzahl 2000 min^{-1} Gewindeformer M10 in C45
Speed 2000 rpm Cold-forming tap M10 in C45

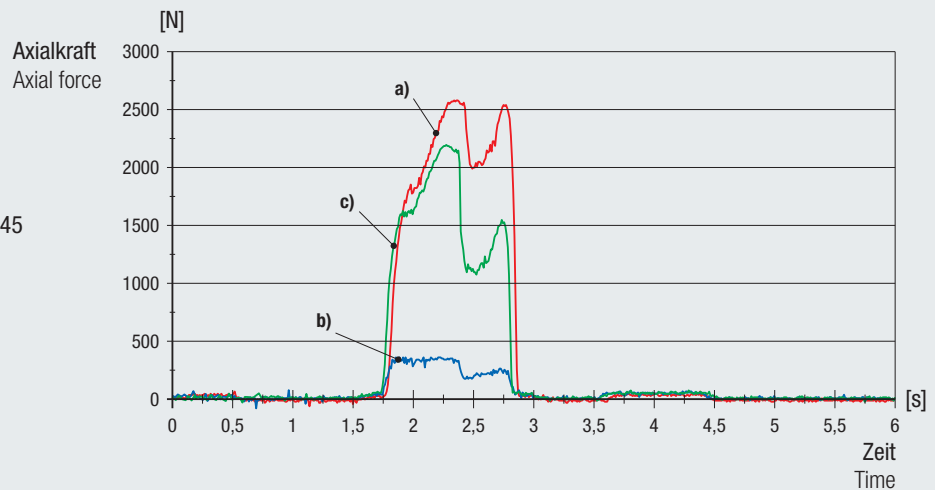

Folgende Erkenntnisse können aus den Versuchen gewonnen werden:

- Die Axialkräfte nehmen mit steigender Drehzahl zu
- Die auftretenden Kräfte beim Gewindeformen mit einer starren Spannzangenaufnahme sind erheblich höher als beim Gewindeformen mit der EMUGE Spannzangen-Aufnahme Typ Softsynchro®
- Die Wettbewerbs-Spannzangen-Aufnahme dämpft im Vergleich zur starren Spannzangen-Aufnahme die Kräfte nur leicht

The following results were verified in these tests:

- Axial forces increase with the raise of speed
- The forces which come into play in the coldforming of threads are considerably higher with a rigid collet holder than with an EMUGE collet holder type Softsynchro®
- The competition collet holder can absorb the upcoming forces only lightly, in comparison with the rigid collet holder

Product Finder

Soft-synchro

Speed-synchro

KSN

MQL MMS

SFM

SWITCH-MASTER

GR, GR-S

HF

EM

Zubehör Accessories

Tech. Info



- Product Finder
- Soft-synchro
- Speed-synchro
- KSN
- ML MMS
- SFM
- SWITCH-MASTER
- GR, GR-S
- HF
- EM
- Zubehör Accessories
- Tech. Info

7.4 Synchrone Gewindeherstellung

Was ist die Ursache für das hervorragende Axialkraftverhalten der EMUGE Spannzangen-Aufnahmen Softsynchro® mit Minimal-längenausgleich?

Wichtiges Merkmal ist die patentierte konstruktive Trennung der Übertragung von Drehmoment und Axialkraft.

Weitere konstruktive Merkmale der EMUGE Spannzangen-Aufnahmen Softsynchro® sind:

- **C-Achsen-Spielfreiheit des Gewindegewindeschneidfutters durch form-schlüssige Drehmomentübertragung über Stahlkugeln**
- **Weiches Ansprechen des vorgespannten Minimallängenausgleichs nach Überschreitung der konstruktiv vorgegebenen Führungskraft durch nahezu verlustfreie Rollreibung der Drehmomentübertragungskugeln in ihren Kugellaufbahnen**
- **Minimaler Längenausgleich und Axialkraftübertragung über vorgespannte Elastomerfedern**
- **Elastomerfedern, die durch ihre Dämpfungseigenschaften ein Aufschwingen der Werkzeugschneide verhindern**

Wird die Trennung der Übertragung von Axialkraft und Drehmoment nicht berücksichtigt, dann wird – wie bei dem Beispiel des Wettbewerb-futters zu sehen – schon zu Beginn der Gewindebearbeitung ein Axialfehler erzeugt. Die Folge ist – wie in den Diagrammen auf der vorhergehenden Seite zu erkennen – ein sofortiges starkes Ansteigen der Axialkraft. Dies wird durch eine praxisbezogene Konstruktion der Spannzangen-Aufnahmen wie beim Softsynchro® verhindert.

Für Werkzeugmaschinen, die die Eigenschaft einer synchronen Gewindebearbeitung nicht zur Verfügung stellen, ist es notwendig, einen größeren Längenausgleich als beim Minimallängenausgleich der Softsynchro® Futter zu verwenden.

Dafür stellt EMUGE Längenausgleichsfutter KSN/HD mit Zangenaufnahme und innerer Kühlschmierstoff-Zufuhr zur Verfügung. Hierbei werden die Vorteile der Spannung des Gewindewerkzeugs über Spannzangen mit denen eines klassischen Längenausgleichsfutters kombiniert.

7.4 Rigid tapping

What is the reason for the outstanding axial force performance of the EMUGE Softsynchro® tap holders with minimum length compensation? Important feature is the patented designed separation of torque and axial force transmission.

Further design features of the EMUGE Softsynchro® tap holders are:

- **Clearance-free C-axes by formfitting torque transmission over steel balls.**
- **Smooth response of the pre-stressed minimum length compensation after exceeding the constructive defined guiding force by nearly loss-free roll friction of the torque transmission balls in their ball tracks.**
- **Minimum length compensation and axial force transmission over pre-stressed elastomer springs.**
- **Elastomer springs preventing the tool cutting edge from bracing by their damping characteristics.**

If the separation of torque and axial force transmission is disregarded, an axial fault is caused immediately when starting the thread cutting process, see example of the competition collet holder. Consequently, the axial force immediately increases heavily, see graphs on the preceding page. This is avoided by the practical-related design of the Softsynchro®.

For machine tools not providing the feature of synchronous thread machining it is necessary to use a larger length compensation than the minimum length compensation of the Softsynchro® holders.

EMUGE supplies length compensation holders KSN/HD with collet adaptation and internal coolant supply. The advantages of clamping the tool over collets are combined with those of a classic length compensation holder.

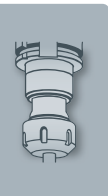

7.5 Spannzangen-Aufnahmen Softsynchro® Modular

Ergänzung der Typenreihe Softsynchro®

Auf Grund der Anforderung verschiedenster Anwender aus dem Automobilbereich wurde die erfolgreiche Typenreihe Softsynchro® um die Variante Softsynchro® Modular erweitert.

Die **Modularität** der Spannzangen-Aufnahmen besteht aus **variabel austauschbaren Übergabeelementen** und **Längeneinstellschrauben**.

Ein Gewindedrahteinsatz erlaubt eine kraftabhängige, minimale Axialbewegung der Längeneinstellschraube. Die beim Anziehen der Spannmutter auf das vorgeschriebene Anzugsdrehmoment entstehende Axialkraft zwischen Längeneinstellschraube und Gewindewerkzeug wird dabei minimiert.

Moderne Werkzeugmaschinen zeichnen sich durch eine hohe Rotationsbeschleunigung der Spindel aus. Durch den Gewindedrahteinsatz wird die Längeneinstellschraube zusätzlich gegen Verdrehen beim Umschalten der Spindeldrehrichtung gesichert.

Die neue Variante Softsynchro® Modular ist für die Minimalmengenschmierung (MMS) als Ausführung **Softsynchro® Modular/MQL** und für die innere Kühlschmierstoff-Zufuhr (IKZ) als Ausführung **Softsynchro® Modular/IKZ** erhältlich.

7.5 Collet holders Softsynchro® Modular

Completion of the Softsynchro® series

Because of the requirement of various users from the automotive industry, the successful Softsynchro® series has been expanded by the version Softsynchro® Modular.

The **modularity** of the collet holders consists of **variable exchangeable transfer elements** and **length adjustment screws**.

A wire thread insert allows a force-dependent minimal axial movement of the length adjustment screw. The axial force between length adjustment screw and threading tool – arising during tightening the clamping nut to the required tightening torque – is minimised by this design.

Modern machine tools stand out with a high rotation acceleration of the spindle. The wire thread insert secures the length adjustment screw additionally against twisting during switching of the spindle rotation direction.

The new version Softsynchro® Modular is available for minimum quantity lubrication (MQL) as **Softsynchro® Modular/MQL** and for internal coolant supply (IKZ) as **Softsynchro® Modular/IKZ**.

- Product Finder
- Softsynchro
- Speedsynchro
- KSN
- MQL MMS
- SFM
- SWITCH-MASTER
- GR, GR-S
- HF
- EM
- Zubehör Accessories
- Tech. Info**

Softsynchro® Modular/MQL

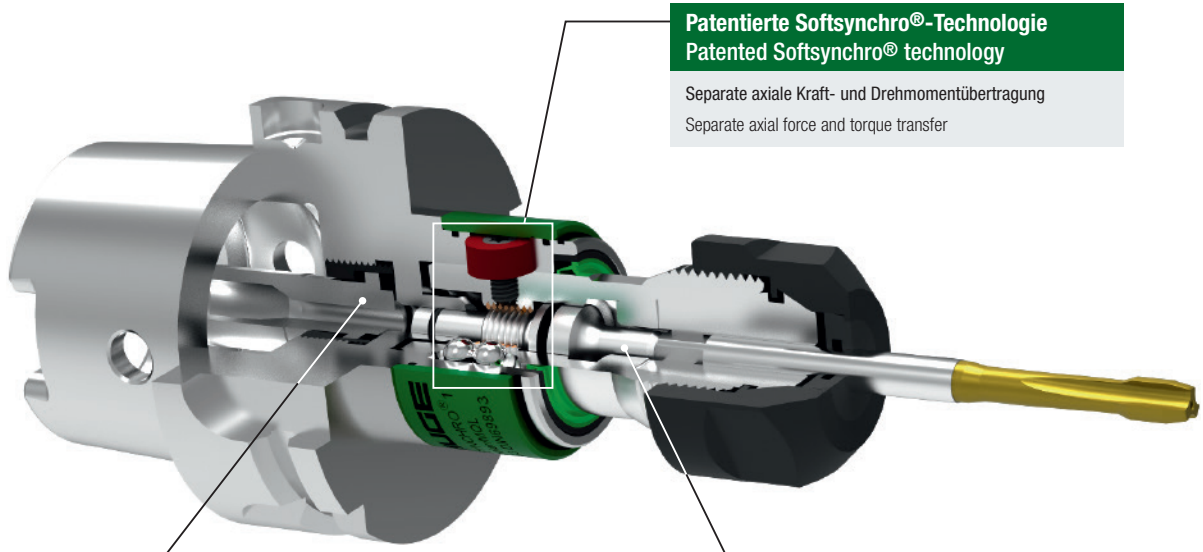

Patentierte Softsynchro®-Technologie
Patented Softsynchro® technology
 Separate axiale Kraft- und Drehmomentübertragung
 Separate axial force and torque transfer

MMS-Übergabeelement
MQL transfer element

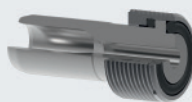
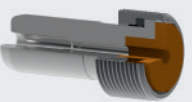
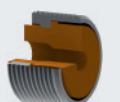
-  Kühlschmierstoff-Rohr HSK-A für 1-Kanal-MMS-System
Coolant tube HSK-A for 1-channel MQL system
-  Kühlschmierstoff-Rohr HSK-A für 2-Kanal-MMS-System
Coolant tube HSK-A for 2-channel MQL system
-  Füllstück bei Verwendung von HSK-A als HSK-C für 1-Kanal-MMS-System
Adapter for application of HSK-A as HSK-C for 1-channel MQL system

Längeneinstellschraube
Length adjustment screw

-  Innenkegel, für Werkzeugschaft mit Außenzentrierung 90°
Internal taper, for tool shank with male centre 90°
-  Außenkegel, für Werkzeugschaft mit Innenzentrierung 60°
External taper, for tool shank with female centre 60°

- Product Finder
- Softsynchro
- Speedsynchro
- KSN
- MQL MMS
- SFM
- SWITCH-MASTER
- GR, GR-S
- HF
- EM
- Zubehör Accessories
- Tech. Info

7.5 Spannzangen-Aufnahmen Softsynchro® Modular

7.5 Collet holders Softsynchro® Modular

Softsynchro® Modular/IKZ

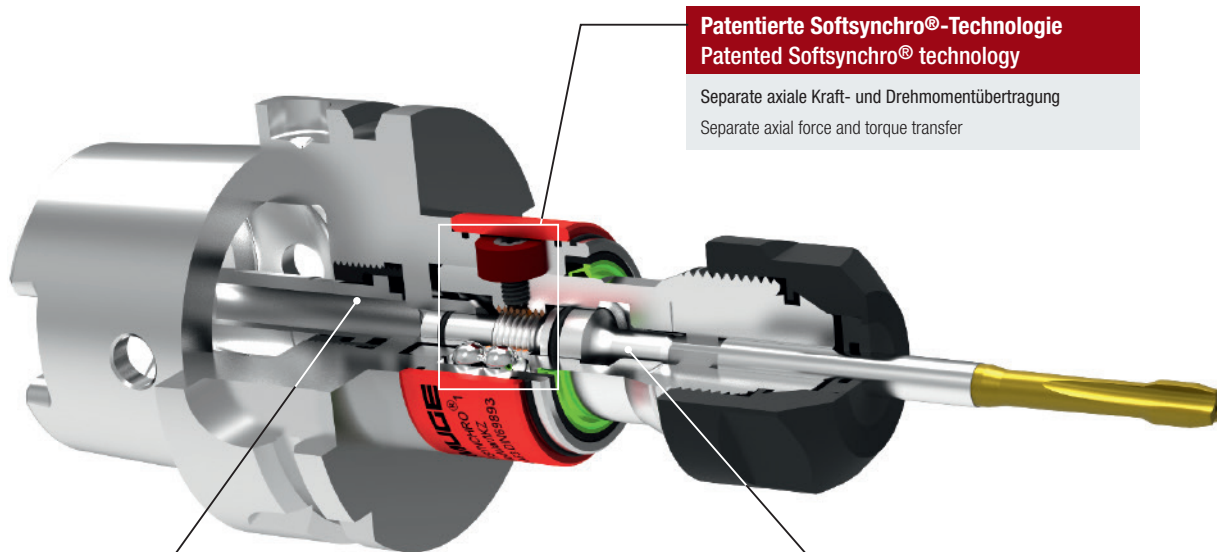

Patentierte Softsynchro®-Technologie Patented Softsynchro® technology

Separate axiale Kraft- und Drehmomentübertragung
Separate axial force and torque transfer

MMS-Übergabeelement MQL transfer element

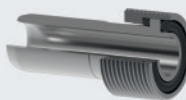

Standard-Kühlschmierstoff-Rohr HSK-A nach DIN 69895
Standard coolant tube HSK-A acc. DIN 69895

Längeneinstellschraube Length adjustment screw



Für Werkzeugschaft mit Innen- oder Außenzentrierung
For tool shank with male or female centre

Das Softsynchro® Modular bietet die gleichen Vorteile des Minimallängenausgleichs wie bei der synchronen Gewindebearbeitung. Mehr zum Thema siehe **7.4 Synchrone Gewindeherstellung**.

The Softsynchro® Modular offers the same advantages of the minimum length compensation as in a synchronous thread machining. For more information on this topic, see **7.4 Rigid Tapping**.

Eine Anleitung zur Montage der Dichtscheibe, Spannzange und Werkzeug sowie korrekte Anzugsdrehmomente siehe **Kapitel 7.2 Montage von Dichtscheibe, Spannzange und Werkzeug**.

For an instruction on how to assemble the sealing disk, collet and tool as well as correct torques, please refer to chapter **7.2 Assembly of sealing disk, collet and tool**.

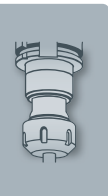

7.6 Minimalmengenschmierung (MMS)

Allgemeines

Unter Minimalmengenschmierung versteht man das Kühlen von Zerspanungsprozessen mit sehr geringen Mengen Kühlschmierstoff. Dabei ist es wichtig, dass der Kühlschmierstoff geradlinig an die Wirkstelle Werkzeug/Werkstück geführt wird, um dort die Entstehung von Reibwärme zu reduzieren. Der Kühlschmierstoff muss auch bei häufigem Werkzeugwechsel prozesssicher dosiert und zum Werkzeug geleitet werden. Von Minimalmengenschmierung spricht man, wenn eine Menge von 5 bis 50 ml/h des MMS-Mediums verbraucht wird, als Trägermedium dient Luft. Das Verfahren ist eine Weiterentwicklung der Nassbearbeitung, bei der die Bearbeitungsstelle mit Kühlschmierstoff geflutet wird. Eine weitere Variante ist die Trockenbearbeitung, die ganz auf Kühlschmierstoffe bei der Zerspanung verzichtet.

Unterscheidung der MMS-Systeme

Generell wird zwischen **externen** und **internen** MMS-Systemen unterschieden:

- Bei der **externen** Zuführung wird das Luft-Öl-Gemisch von außen an die Bearbeitungsstelle über eine im Bearbeitungsraum der Werkzeugmaschine installierte Düse zugeführt. Es sind keine speziellen Halter oder Werkzeuge notwendig.
- Bei der **internen** Zuführung wird das MMS-Medium durch eine für Minimalmengenschmierung geeignete Drehdurchführung, die Arbeitsspindel, den Werkzeughalter und das Werkzeug direkt bis zur Werkzeugschneide geführt. Hierfür sind spezielle Halter mit einer geraden, strömungsgünstigen Durchführung des MMS-Mediums notwendig. Ebenso werden MMS-optimierte Werkzeuge mit einer an den Halter angepassten Übergabefase und optimierten Austritten benötigt.

Bei der **internen** Zuführung wird wiederum zwischen **1-Kanal-MMS-System** und **2-Kanal-MMS-System** unterschieden:

- Beim **1-Kanal-MMS-System** wird das Luft-Öl-Gemisch vor dem Eintritt in die Maschinenspindel im MMS-Gerät erzeugt und durch die Arbeitsspindel und das Spannsystem zur Wirkstelle geleitet.
- Beim **2-Kanal-MMS-System** werden Öl und Luft getrennt durch die Spindel geführt, die Mischung der beiden Medien erfolgt beim Eintritt in den Werkzeughalter.

7.6 Minimum-quantity lubrication (MQL)

General information

By minimum-quantity lubrication, we mean the cooling of machining processes with very small amounts of coolant-lubricant. In this, it is important that the coolant-lubricant is conveyed directly to the point of contact between tool and workpiece in order to reduce the generation of heat by friction there. Even with repeated tool changes, the coolant-lubricant must be dosed and transported to the tool with the highest possible degree of process safety. The term minimum-quantity lubrication applies when a quantity of 5 to 50 ml/h of the MQL medium is consumed, air is used as a carrier medium. This technique is a redeveloped version of wet machining where the machining area is flooded with coolant-lubricant. Another technique is dry machining which is done completely without coolant-lubricant.

Different MQL systems

Generally, we make a distinction between **external** and **internal** MQL systems:

- With **external** supply systems, the aerosol containing the oil is sprayed onto the point of machining through a jet installed in the machining space of the machine tool. No special holders or tools are needed.
- With **internal** supply systems, the MQL medium is conveyed through a rotary transmission, the work spindle, the tool holder and the tool itself, directly to the cutting edge of the tool. For such systems, special holders with a straight feed-through of the MQL medium for perfect flow are necessary. What is also needed are tools specially designed for MQL, with a transfer chamfer adjusted to the holder and with optimised coolant-lubricant outlets.

With the **internal** supply systems, we make a further distinction between **1-channel MQL** systems and **2-channel MQL** systems:

- In a **1-channel MQL** system, the aerosol is generated in the MQL device before it enters into the machine spindle, and is then conducted through the work spindle and the clamping system to the point where it is needed.
- In a **2-channel MQL** system, oil and air are conducted through the spindle separately, the mixing of the two media is done only at the point where they enter the tool holder.

1-Kanal-MMS-System
1-channel MQL system

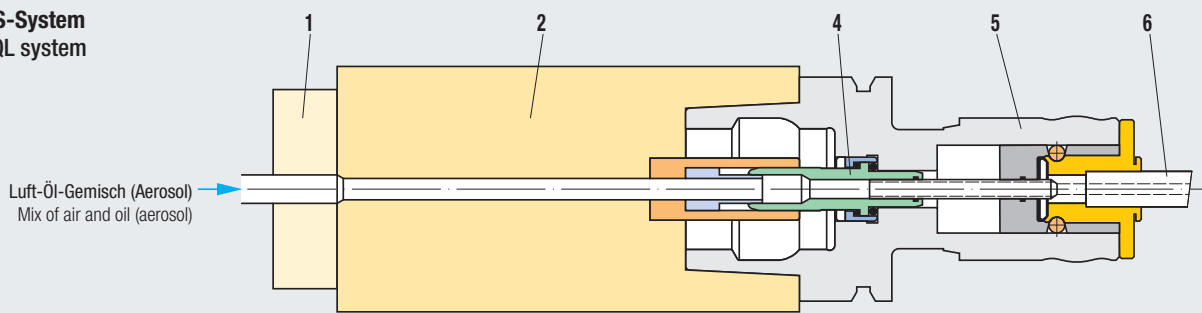

2-Kanal-MMS-System
2-channel MQL system

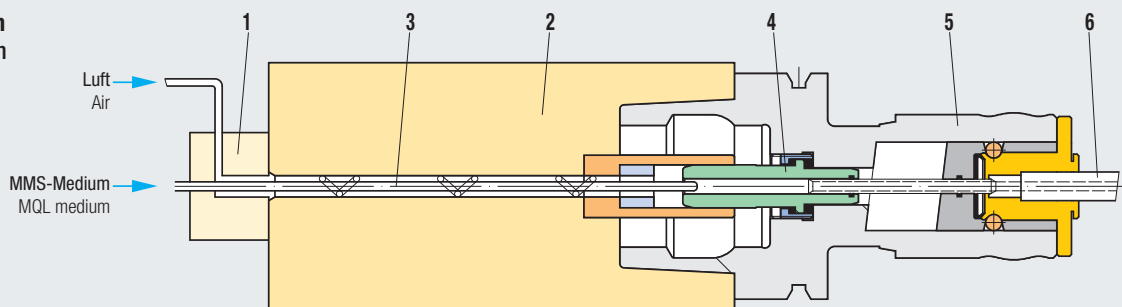

- | | | |
|--|---|---|
| 1 Drehdurchführung
Rotary transmission | 3 MMS-Medium-Lanze
MQL medium lance | 5 Werkzeug-Aufnahme
Tool holder |
| 2 Arbeitsspindel
Work spindle | 4 Übernahmeeinheit
Transfer unit | 6 Werkzeug
Tool |

- Product Finder
- Soft-synchro
- Speed-synchro
- KSN
- MQL MMS
- SFM
- SWITCH-MASTER
- GR, GR-S
- HF
- EM
- Zubehör Accessories
- Tech. Info**

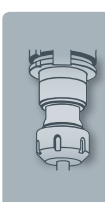

- Product Finder
- Softsynchro
- Speedsynchro
- KSN
- ML MMS
- SFM
- SWITCH-MASTER
- GR, GR-S
- HF
- EM
- Zubehör Accessories
- Tech. Info

7.6 Minimalmengenschmierung (MMS)

Die Werkzeug-Aufnahmen

Die Werkzeug-Aufnahmen für Minimalmengenschmierung müssen nicht nur das Werkzeug sicher spannen, sondern auch einen ungehinderten, verlustfreien und strömungsoptimierten Durchfluss des Luft-Öl-Gemisches ermöglichen. Beim 2-Kanal-MMS-System muss zusätzlich noch bei der Übergabe von der Spindel zum Schaft das Gemisch aus Luft und Öl erzeugt werden. Durch diese Anforderungen sind spezielle Schnellwechsel- und Spannzangen-Aufnahmen entstanden, die den jeweiligen Anforderungen der MMS-Systeme gerecht werden. Zusätzlich wurden Werknormen bzw. die Norm E DIN 69090 erarbeitet, welche die Übergabestellen von der Spindel zur Werkzeug-Aufnahme festlegen. Auch diesen Normen werden die EMUGE-Aufnahmen gerecht.

Um Toträume und Versackungen zu vermeiden, bietet EMUGE auch die für die Minimalmengenschmierung passenden Werkzeuge an. Die Übergabe von der Werkzeug-Aufnahme zum Werkzeug kann somit optimal aufeinander abgestimmt werden.

Folgende Werkzeug-Aufnahmen stehen zur Verfügung:

1. KSN/MQL

Diese Schnellwechsel-Aufnahmen sind mit einem Längenausgleich auf Zug und Druck, dem von EMUGE patentierten Druckpunktmechanismus und der bewährten Zugausrastung ausgestattet. Zusätzlich wird durch ein angefedertes Rohr eine hindernisfreie Führung des Luft-Öl-Gemisches erreicht. Dieses Rohr sorgt auch für eine permanente Übergabe des Gemisches von der Werkzeug-Aufnahme zum Werkzeug. Dazu passend bietet EMUGE Einsätze vom Typ EM/MQL an, die planseitig zwischen Schnellwechsel-Aufnahme und Schnellwechsel-Einsatz abdichten. Diese planseitige Abdichtung ist vor allem bei der Gussbearbeitung und bei „Überkopf“-Bearbeitungen vorteilhaft.

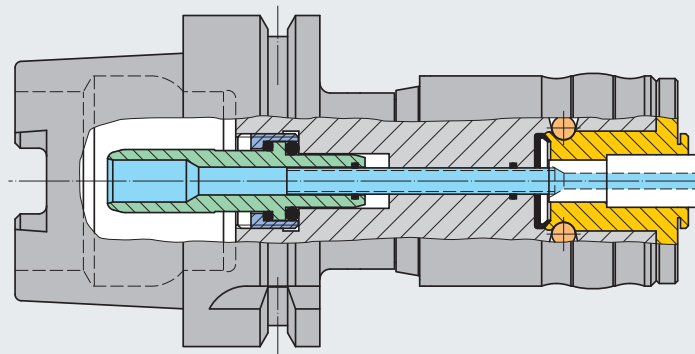

2. Softsynchro®/MMS

Diese Spannzangen-Aufnahmen sind mit dem bekannten Minimal­längen­ausgleich mit getrennter Drehmoment- und Kraftübertragung ausgestattet, siehe auch **7.4 Synchrone Gewindeherstellung**. Auch hier ist eine strömungsoptimierte Führung durch ein angefedertes Rohr gegeben. Dieses steht durch die Anfederung immer sicher am Ende des Werkzeugschaftes an und garantiert eine verlustfreie Übergabe.

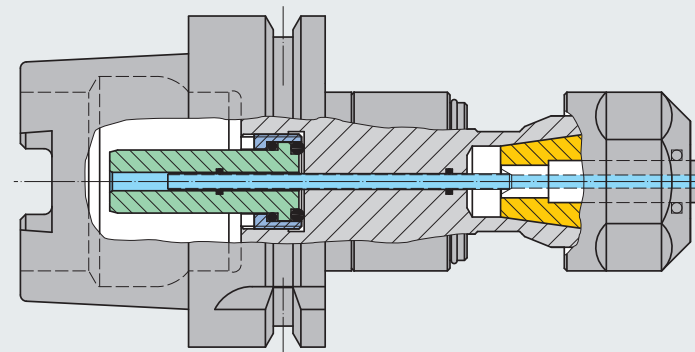

7.6 Minimum-quantity lubrication (MQL)

The tool holders

Tool holders for minimum-quantity lubrication must not only provide safe clamping for the tool, but must also permit unhindered, loss-free and free-flow through-feed of the aerosol. In 2-channel MQL systems, it is also necessary to produce the mix of oil and air during the transfer from the spindle to the shank. These challenges have led to the design of special quick-change and collet holders which meet the requirements of the different MQL systems.

Additionally, several company standards and the standard E DIN 69090 were established for a clear specification of the point of transfer from spindle to tool holder. Our EMUGE holders, needless to say, meet all the requirements of these standards, too.

In order to avoid dead spaces and oil clogs, EMUGE offers also the suitable tools for minimum-quantity lubrication. With their detailed adjustment to the holders, an optimised transfer from tool holder to tool can be guaranteed.

The following tool holders are available:

1. KSN/MQL

These quick-change holders are equipped with length compensation on tension and compression, with the EMUGE patented pressure-point mechanism and the proven front release. In addition, a spring-loaded tube guarantees a disturbance-free feed-through of the aerosol. This same tube also provides the permanent transfer of the aerosol from the tool holder to the tool. As a complement, EMUGE offers adapters type EM/MQL which provide a sealing surface between quick-change holder and quick-change adapter. This sealing surface is especially helpful in the machining of cast materials and in "overhead" machining situations.

2. Softsynchro®/MQL

These collet holders are equipped with the well-known minimal length compensation with separate transfer of torque and axial force, see also chapter **7.4 Rigid tapping**. Again, there is an optimised feed-through for perfect flow ensured by a spring-loaded tube. This tube is always in firm contact with the end of the tool shank due to the spring pressure, and guarantees loss-free transfer.

7.7 Spannzangen-Aufnahmen Speedsynchro® Modular

Anwendungsbereich

Speedsynchro® Modular sind für den Einsatz auf CNC-gesteuerten Werkzeugmaschinen konzipiert.

Funktionsweise

Das Speedsynchro® Modular verfügt über ein integriertes Übersetzungsgetriebe mit einem Übersetzungsverhältnis von 1 : 4,412 und ist mit der patentierten Softsynchro®-Minimallängenausgleichsfunktion kombiniert.

Das Übersetzungsgetriebe ermöglicht

- Sich im unproblematischen, relativ niedrigen synchronen Spindel-drehzahlbereich ($< 1500 \text{ min}^{-1}$) der Werkzeugmaschine zu bewegen
- Hohe Schnittgeschwindigkeiten des Gewindewerkzeuges durch die Vervielfachung der Spindeldrehzahl zu realisieren

Allgemeine Spezifikationen

- **Höhere Schnittgeschwindigkeit**
Maschinenspindeln erreichen bei der synchronen Gewindeherstellung ab einer bestimmten Spindeldrehzahl nicht mehr die programmierten Drehzahlen. Durch das Übersetzungsgetriebe im Speedsynchro® Modular werden diese wieder ermöglicht.
- **Höhere Werkzeugstandzeit**
Durch die patentierte Minimallängenausgleichsfunktion wird die Axialkraft am Gewindewerkzeug reduziert.
- **Reduzierung der Energieaufnahme**
Durch das Übersetzungsgetriebe ergibt sich eine geringere Drehzahl der Maschinenspindel und damit über 90% Energieeinsparung im Vergleich zur synchronen Gewindeherstellung.
- **Geringere Anlagenkosten**
Geringerer Energieverbrauch durch den Einsatz von Minimalmengenschmierung (MMS).
 - **Modulare MQL-Rohre**
Umbau von 1- auf 2-kanalige MQL-Systeme.
 - **Modulare Längeneinstellschrauben**
Anpassung der Längeneinstellschrauben an innen- oder außenzentrierte Gewindewerkzeuge.

Technische Eigenschaften

- Schneidbereich: M1 - M8
- Spannzangenaufnahme: ER16
- Übersetzungsverhältnis: 1 : 4,412
- Max. Spindeldrehzahl: 2000 min^{-1}
- Max. Werkzeugdrehzahl: 8824 min^{-1}
- Innere Kühlschmierstoff-Zufuhr
- MMS für 1- oder 2-Kanal-Systeme

7.7 Collet holders Speedsynchro® Modular

Application range

Speedsynchro® Modular are designed for use on CNC-controlled machine tools.

Functionality

The Speedsynchro® Modular uses an integrated transmission gearing with a transmission ratio of 1 : 4.412 and combines it with the patented Softsynchro® minimal length compensation function.

The transmission gearing allows

- To work in the unproblematic and relatively low synchronous spindle speed range ($< 1500 \text{ rpm}$) of the machine tool
- To achieve high cutting speeds of the threading tool due to a multiplication of the spindle speed

General specifications

- **Higher cutting speeds**
In a synchronous thread production machine spindles do not achieve the programmed rotational speeds above a certain spindle speed. The transmission gearing of the Speedsynchro® Modular keeps up with the programmed speeds.
- **Longer tool life**
The patented minimal length compensation function reduces the axial force on the tap.
- **Reduction of energy consumption**
Thanks to the transmission gearing the rotational speed of the machine spindle is reduced which results in energy savings of more than 90% compared to synchronous thread machining..
- **Reduced installation costs**
Lower energy consumption due to the use of minimum quantity lubrication (MQL).
 - **Modular MQL tubes**
Conversion from 1-channel to 2-channel MQL-systems.
 - **Modular length adjustment screws**
Adaptation of length adjustment screws to threading tools with male or female centre.

Technical characteristics

- Cutting range: M1 - M8
- Collet: ER16
- Transmission ratio: 1 : 4.412
- Max. spindle speed: 2000 rpm
- Max. tool speed: 8824 rpm
- Internal coolant supply
- MQL for 1-channel or 2-channel systems

Mehr Informationen zum Speedsynchro® Modular unter

www.speedsynchro.com

More information regarding Speedsynchro® Modular at



- Product Finder
- Soft-synchro
- Speed-synchro
- KSN
- MQL MMS
- SFM
- SWITCH-MASTER
- GR, GR-S
- HF
- EM
- Zubehör Accessories
- Tech. Info

7.7 Spannzangen-Aufnahmen Speedsynchro® Modular

Vorteile des Speedsynchro® Modular

- Einfache Programmierung als Synchronzyklus mit einer dem Übersetzungsverhältnis angepassten Vorschubprogrammierung
- Ermittlung der Zeitvorteile Speedsynchro® Modular / Synchronzyklus durch „Simulation“ ohne Speedsynchro® Modular und Werkzeug möglich
- Exakte Gewindetiefen – keine von Gewindeschneidapparaten bekannten Gewindetiefenstreuungen, da der Speedsynchro® Modular anders als Gewindeschneidapparate kein Umschalten der Drehrichtung ausführt
- Das Reversieren des Gewindewerkzeuges erfolgt durch die Maschinenantriebs spindle:
 - Keine umschaltenden Bauteile im Speedsynchro® Modular
 - Geringer Verschleiß und geringere Wartungszyklen
 - Wartung unabhängig von der produzierten Gewindeanzahl
- Patentierte, konstruktiv eigenständige Übertragung des Bearbeitungs Drehmoments bei der Gewindeherstellung
- Mechanisch unabhängige Kompensierung der durch Synchronisationsfehler entstehenden Axialkräfte an den Gewindewerkzeugflanken
- Minimallängenausgleich $\pm 0,5$ mm
- Federnde Lagerung der Längeneinstellschraube zum Ausgleichen der entstehenden Axialkraft zwischen Längeneinstellschraube und Gewindewerkzeug beim Anziehen der Spannmutter
- Selbsthemmung der Längeneinstellschraube gegen unerwünschte Längenverstellung durch Rotationsbeschleunigung während der Drehrichtungsumkehr der Maschinenspindel

Zyklus zur Gewindeherstellung beim Speedsynchro® Modular

Der Speedsynchro® Modular wird mittels Werkzeugwechsler in die Maschinenspindel eingewechselt, dabei rastet der Fixierbolzen in den Arretierblock ein, die Arretierung wird gelöst und der Speedsynchro® Modular ist bereit.

Hinweise zur Programmierung

Das Übersetzungsverhältnis des Speedsynchro® Modular beträgt 1:4,412. Daraus ergeben sich folgende Programmiervorschriften:

- Vorschub f

$$f = P \times 4,412 \quad [\text{mm/U}]$$

- Drehzahl n der Maschinenspindel für die gewünschte Werkzeugdrehzahl

$$n_{\text{MSP}} = n_{\text{WZG}} / 4,412 \quad [\text{min}^{-1}]$$

- P = Gewindewerkzeugsteigung [mm]
- n_{MSP} = Drehzahl Maschinenspindel [min^{-1}]
- n_{WZG} = Drehzahl Gewindewerkzeug [min^{-1}]

Beispiel Gewinde M6 / Gewindesteigung P = 1 mm:

- Gewünschte Drehzahl am Gewindewerkzeug:
 $n_{\text{WZG}} = 3000 \text{ min}^{-1}$
- Erforderliche Drehzahl an der Maschinenspindel:
 $n_{\text{MSP}} = 3000 \text{ min}^{-1} / 4,412 = 680 \text{ min}^{-1}$
- Erforderlicher Vorschub:
 $f = 1 \times 4,412 \text{ mm/U} = 4,412 \text{ mm/U}$

Serviceleistung

Für den Austausch von Verschleißteilen bietet EMUGE einen Reparaturservice an. Dieser beinhaltet die fachgerechte Instandsetzung, Durchführung einer Druckprüfung und Funktionskontrolle mit Übernahme der vollen Garantie.

7.7 Collet holders Speedsynchro® Modular

Advantages of the Speedsynchro® Modular

- Simple programming as synchronous cycle with feed programme adapted to the transmission ratio
- Evaluation of time benefit of the Speedsynchro® Modular / synchronous cycle by a "simulation" without Speedsynchro® Modular and tool
- Accurate thread depths – no variations in thread depths associated with conventional tapping attachments since the Speedsynchro® Modular in contrast to tapping attachments does not reverse the sense of rotation
- The reversal of the threading tool is done by the machine drive spindle:
 - No switching components in the Speedsynchro® Modular
 - Low wear and longer maintenance intervals
 - Maintenance independent of number of threads produced
- Patented constructive independent transfer of the machining torque in the production of threads
- Mechanically independent compensation of the axial forces at the threading tool flanks caused by synchronisation faults
- Minimum length compensation ± 0.5 mm
- Spring-loaded bearing of the length adjustment screw for compensation of the occurring axial force between length adjustment screw and threading tool when tightening the clamping nut
- Self-locking of the length adjustment screw against unwanted length displacement caused by rotation acceleration during reversal of rotation direction of the machine spindle

Thread production cycle with the Speedsynchro® Modular

The Speedsynchro® Modular is changed into the machine by means of the tool exchanging device, the stop fixture bolt engages in the stop block, the locking device is released and the Speedsynchro® Modular is ready for operation.

Some programming references

The transmission ratio of the Speedsynchro® Modular is 1:4.412 which results in the following programming guidelines:

- Feed f

$$f = P \times 4.412 \quad [\text{mm/rev.}]$$

- Rotational speed n of machine spindle for the desired tool speed

$$n_{\text{MSP}} = n_{\text{TOOL}} / 4.412 \quad [\text{rpm}]$$

- P = Pitch of threading tool [mm]
- n_{MSP} = Rotational speed of machine spindle [rpm]
- n_{TOOL} = Rotational speed of threading tool [rpm]

Example thread M6 / pitch P = 1 mm:

- Desired rotational speed of threading tool:
 $n_{\text{TOOL}} = 3000 \text{ rpm}$
- Required rotational speed of machine spindle:
 $n_{\text{MSP}} = 3000 \text{ rpm} / 4.412 = 680 \text{ rpm}$
- Required feed:
 $f = 1 \times 4.412 \text{ mm/rev.} = 4.412 \text{ mm/rev.}$

Service

In case spare parts need to be exchanged, EMUGE offers you a repair service that includes e.g. competent repair and maintenance, a professional pressure check and function control with full guarantee.



7.7 Spannzangen-Aufnahmen Speedsynchro® Modular

7.7 Collet holders Speedsynchro® Modular

Auslegung der Transportarretierung für Speedsynchro® Modular

Zum Einsatz des Gewindeschneidapparates ist eine Transportarretierung erforderlich, die folgende Aufgaben übernimmt:

- Abstützung der beim Arbeitseinsatz entstehenden Drehmomente
- Korrekte Positionsbestimmung zwischen Maschinenspindel und Transportarretierung bei Verwendung von automatischen Werkzeugwechslern

Die Transportarretierung wird in der Regel vor Auslieferung individuell an die Maschine angepasst.

Technical design of the stop fixture for the Speedsynchro® Modular

For the use of our tapping attachments, a stop fixture is needed for the following functions:

- Supporting the torque caused by the operation of the attachment
- Correct definition of the position between machine spindle and stop fixture whenever automatic tool exchange devices are used

The stop fixture is normally fitted individually to the customer's machine before shipping of the attachment.

Maßangaben zur Transportarretierung
Specifications of the stop fixture

Adresse:
.....
.....
.....

Maschinenhersteller/-bezeichnung:
.....

Arretierblock an der Maschine vorhanden?
 Ja Nein

Schaftausführung und Größe:
.....

Spindelbezeichnung mit den Anschlussmaßen für die Transportarretierung vorhanden?
 Ja (bitte Kopie beilegen)
 Nein, Maße: A: B:
E: W:

Address:
.....
.....
.....

Machine manufacturer / designation:
.....

Locking block available on machine?
 Yes No

Shank type and size:
.....

Spindle designation with connecting dimensions for stop fixture available?
 Yes (please enclose a copy)
 No, dimensions: A: B:
E: W:

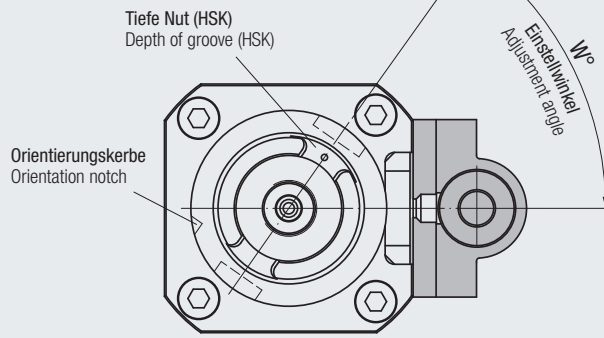
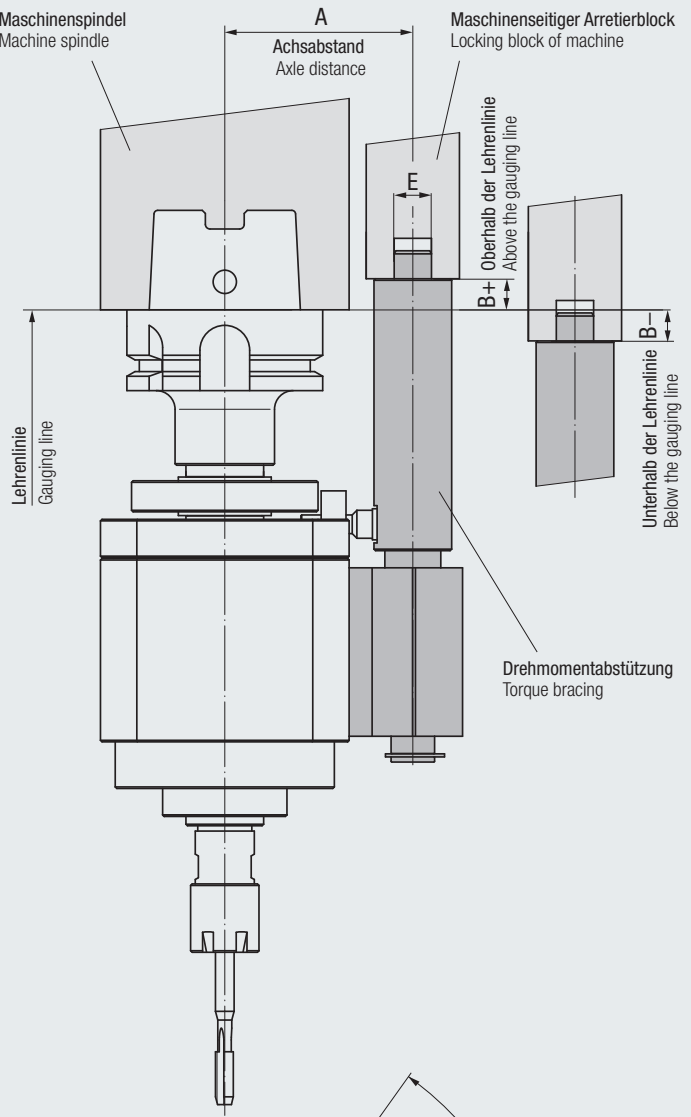

- Product Finder
- Softsynchro
- Speedsynchro
- KSN
- MQL MMS
- SFM
- SWITCH-MASTER
- GR, GR-S
- HF
- EM
- Zubehör Accessories
- Tech. Info

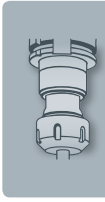

- Product Finder
- Soft-synchro
- Speed-synchro
- KSN
- ML MMS
- SFM
- SWITCH-MASTER
- GR, GR-S
- HF
- EM
- Zubehör Accessories
- Tech. Info

7.8 Werkzeugüberwachungssystem DDU4

Das Werkzeugüberwachungssystem DDU4 ist die konsequente Weiterentwicklung der bislang bekannten ICS- bzw. TTS-Systeme. Zusätzlich zum aktuellen Drehmoment kann nun gleichzeitig auch die Axialkraft berührungslos in Echtzeit ermittelt werden. Mit fest einstellbaren Regelungs- und Bruchgrenzen in N bzw. Nm in Kombination mit den ARTIS Prozessüberwachungssystemen ist zusätzlich zu den Standardfunktionen folgende Erkennung möglich:

- Werkzeugverschleiß
- Fehlendes Werkzeug
- Fehlerhafte Kernlochbohrung
- Unterschiedliche Gewindetiefen
- Materialberührung
- Werkzeugbruch

Durch digitale Messsignalverarbeitung konnte der Drehmoment- und Axialkraft-Messbereich erweitert werden. Diese Messbereiche sind in jeweils drei Stufen unterteilt und können extern angewählt werden.

Das DDU4 ist in zwei Ausführungen erhältlich:

1. Basislösung DDU4 als „Stand-alone System“

Hierbei handelt es sich um ein preisgünstiges Nachrüstsystem zur Werkzeugüberwachung. Es können für das Drehmoment und die Axialkraft je zwei feste Grenzwerte in Nm bzw. kN eingestellt werden. Durch ein integriertes LCD-Display wird der Kurvenverlauf visualisiert und die Einstellungen vorgenommen. Die Alarmsignale werden über je einen Schaltausgang für das Drehmoment und die Axialkraft ausgegeben. In Kombination mit dem Prozessüberwachungssystem CTM dient das DDU4-System als 2-kanaliger Messumformer.



2. DDU4 in Kombination mit CTM

Die Anbindung an das CTM-Prozessüberwachungssystem bietet neben den Standardfunktionen noch weitere Leistungsmerkmale zur Erkennung von:

- Werkzeugverschleiß
- Fehlerhafte Kernlochbohrungen
- Materialberührung
- Späneklemmer
- Fehlendes Werkzeug
- Unterschiedliche Gewindetiefen
- Werkzeugbruch
- Auswertung für statistische Aufzeichnungen

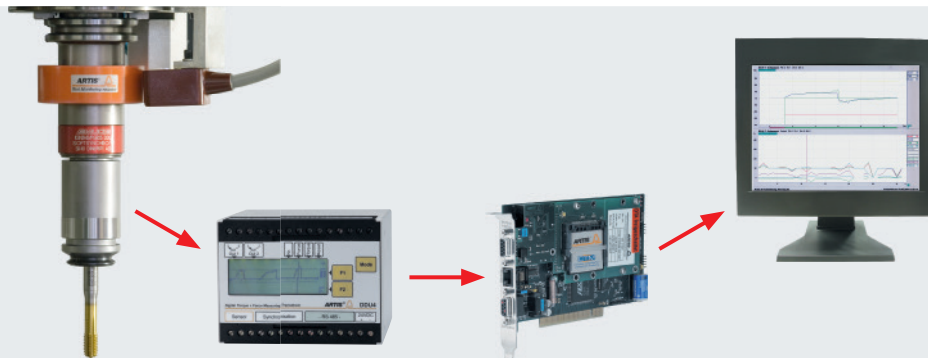

7.8 Tool monitoring system DDU4

The new tool monitoring system DDU4 is a newly developed system, consequently following upon the already successful ICS and TTS systems. In addition to the current torque indication, you can now also monitor the axial force, contact-free, in real-time. With the option to set fixed response and breakage limits in N or Nm in combination with the ARTIS process monitoring systems, the following recognition features become possible in addition to the standard functions:

- Tool wear
- Missing tool
- Defective thread holes
- Different thread depths
- Material contact
- Tool breakage

Digital signal processing made it possible also to enlarge the measuring range for torque and axial force. These measuring ranges are each subdivided into three steps, each of which can be called off externally.

The DDU4 system is available in two versions:

1. Basic solution: DDU4 as “stand-alone system”

This is an economically efficient upgrading system for tool monitoring. For both torque and axial force, two fixed limit values in Nm or kN can be set. An integrated LCD display will visualize the curve progress, and serve for entering the requested values. Alarm signals are emitted by one switch each for torque and axial force.

In combination with the process monitoring system CTM, the DDU4 system will serve as a 2-channel measuring converter.

2. DDU4 in combination with CTM

In combination with the CTM process monitoring system, the DDU4 system will offer you as additional performance characteristics the recognition of:

- Tool wear
- Defective thread holes
- Material contact
- Chip clogging
- Missing tool
- Different thread depths
- Tool breakage
- Evaluation for statistical purposes

7.9 Gewindeschneidapparate SWITCH-MASTER®

7.9 Tapping attachments SWITCH-MASTER®

Anwendungsbereich

Gewindeschneidapparate der Typenreihen SWITCH-MASTER® sind für den Einsatz auf CNC-gesteuerten Werkzeugmaschinen konzipiert.

Allgemeine Spezifikationen

- Durch das integrierte Wendegetriebe entfällt der Drehrichtungswechsel der Maschinenspindel beim Rücklauf. Die im Wendegetriebe eingebauten Dämpfungselemente kompensieren die durch den Drehrichtungswechsel des Apparate-Spannkopfes auftretenden Beschleunigungskräfte. Die daraus resultierenden Vorteile sind:
 - Zeitersparnis durch kürzere Taktzeiten
 - Schonung der Maschinenspindel durch konstanten Rechtslauf
 - maximale Standzeit der Gewindewerkzeuge
 - Energieeinsparung durch nahezu gleichbleibende Stromaufnahme
- Auslegung für Kühlschmierstoff-Druck bis 50 bar (700 psi)
- Sichere und rundlaufgenaue Klemmung des Gewindewerkzeugs über Spannzangen (für bessere Drehmomentübertragung empfehlen wir Spannzangen Typ ER-GB mit integriertem Vierkant zu verwenden)
- Als Schnittstelle zur Maschinenspindel dient ein Zylinderschaft $\varnothing 25$ mm nach DIN 1835 B+E; durch die Verwendung von Adaptionsschäften ist ein schneller und kostengünstiger Einsatz auf allen gängigen Spindelaufnahmen sichergestellt
- Die Gewindeschneidapparate SWITCH-MASTER® sind zur Herstellung von Rechtsgewinden ausgelegt; es besteht auf Wunsch jedoch die Möglichkeit, den Apparat für Linksgewinde auszuführen – die Drehrichtung der Maschinenspindel bleibt in beiden Fällen immer rechtsdrehend.

Application range

The tapping attachments of our SWITCH-MASTER® series are designed for use on CNC-controlled machine tools.

General specifications

- The integrated reverse gear makes a change of the sense of rotation of the machine spindle for reversal superfluous. The absorption elements integrated in the reverse gear compensate the acceleration forces caused by the change of the sense of rotation of the clamping head. The resulting advantages are as follows:
 - Time savings due to reduced cycle times
 - Reduced stress on the machine spindle due to constant right-hand rotation
 - Maximum tool life of the threading tools
 - Energy savings due to almost constant power consumption
- Design for coolant-lubricant pressure up to 50 bar (700 psi)
- Safe and high-concentricity clamping of the tool by means of collets (for improved torque transfer we recommend using collets type ER-GB with integrated square)
- The connection to the machine spindle is a straight shank dia. 25 mm according to DIN 1835 B+E; the use of adapter shanks is a fast and economically efficient way of guaranteeing the compatibility with all the usual spindle adaptations
- The tapping attachments SWITCH-MASTER® are designed for the production of right-hand threads only, however, there is a possibility of designing the attachment for left-hand threads – the sense of rotation of the machine spindle will always remain right-hand.

- Product Finder
- Soft-synchro
- Speed-synchro
- KSN
- MQL MMS
- SFM
- SWITCH-MASTER
- GR, GR-S
- HF
- EM
- Zubehör Accessories
- Tech. Info

Zeitbedarf bei der Gewindeherstellung mit verschiedenen Werkzeug-Aufnahmen
Time spent on thread production with different tool holders

Konventionelle Werkzeug-Aufnahme
Conventional tool holder

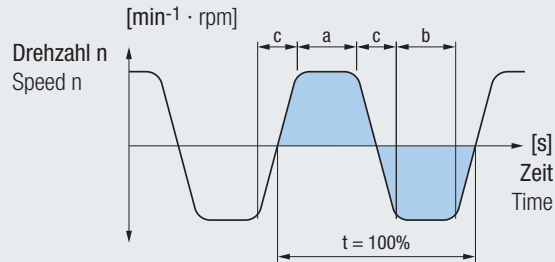

Gewindeschneidapparat SWITCH-MASTER® oder GRN-NC
Tapping attachment SWITCH-MASTER® or GRN-NC

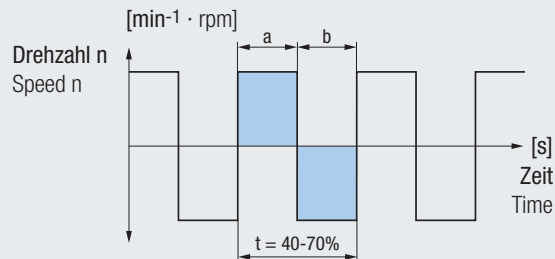

- a = Zeit für Gewindeherstellung
Time for thread production
- b = Zeit für Rücklauf des Gewindewerkzeugs
Time for reversal of the threading tool
- c = Umschaltzeit zwischen Rechts- und Linkslauf des Gewindewerkzeugs
Time for switching from right-hand to left-hand rotation of the threading tool
- t = Zeitbedarf bei der Gewindeherstellung
time spent on thread production

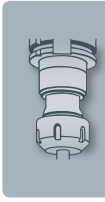

- Product Finder
- Soft-synchro
- Speed-synchro
- KSN
- MQL MMS
- SFM
- SWITCH-MASTER
- GR, GR-S
- HF
- EM
- Zubehör Accessories
- Tech. Info**

7.9 Gewindeschneidapparate SWITCH-MASTER®

Zusätzliche Spezifikationen Typ SWITCH-MASTER®

- Gewindeschneidapparate Typ SWITCH-MASTER® sind in zwei Ausführungen (90°, 180°) erhältlich
- Geeignet für Drehzahlen bis max. 3000 min⁻¹
- Ruhiges, verschleißarmes Laufverhalten durch Ölbad Schmierung
- Sichere Abdichtung gegen Eindringung von Kühlschmierstoff in das Gehäuse durch Trennung der Längs- und Drehbewegung des Spannkopfes
- Minimierter Verschleiß an den Schaltgliedern durch extrem schnelles Umschalten (35 ms) der Drehrichtung
- Erzielung von gleichbleibenden Gewindetiefen durch exakt definierten Umschaltpunkt
- Reduzierter Sicherheitsabstand auf 5 mm zwischen Werkstück und Werkzeug auf Grund kurzer Schaltwege; dadurch wird eine zusätzliche Verringerung der Taktzeit erzielt
- Nahezu konstante Schnittgeschwindigkeit, dadurch Erhöhung der Werkzeugstandzeit
- Für den Drehrichtungswechsel wird maschinenseitig als Hilfsenergie Druckluft (6 $\begin{smallmatrix} +1 \\ -0,5 \end{smallmatrix}$ bar) benötigt

Serviceleistung

Für den Austausch von Verschleißteilen bietet EMUGE einen Reparaturservice an. Dieser beinhaltet die fachgerechte Instandsetzung, Durchführung einer Druckprüfung und Funktionskontrolle mit Übernahme der vollen Garantie.

7.9 Tapping attachments SWITCH-MASTER®

Additional specifications type SWITCH-MASTER®

- Tapping attachments of type SWITCH-MASTER® are available in two designs (90°, 180°)
- Suitable for speeds up to max. 3000 rpm
- Smooth, low-wear operation thanks to oil-bath lubrication
- Safe sealing against the penetration of coolant-lubricant into the housing, by separating the axial and rotational movement of the clamping head
- Minimised wear on the gear elements due to extremely fast changes of the sense of rotation (35 ms)
- Constant thread depths thanks to an exactly defined switching point
- Reduced safety distance of 5 mm between workpiece and tool thanks to short gear change paths; this yields an additional reduction of cycle times
- Almost constant cutting speed, resulting in an increase of tool life
- On the machine side, pressurised air (6 $\begin{smallmatrix} +1 \\ -0,5 \end{smallmatrix}$ bar) is needed as auxiliary energy for the change of the sense of rotation

Service

In case spare parts need to be exchanged, EMUGE offers you a repair service that includes e.g. competent repair and maintenance, a professional pressure check and function control with full guarantee.

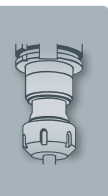

7.9 Gewindeschneidapparate SWITCH-MASTER®

7.9 Tapping attachments SWITCH-MASTER®

Zum Einsatz des Gewindeschneidapparates ist eine Transportarretierung erforderlich:

Ausführliche Informationen zur Auslegung der Transportarretierung für SWITCH-MASTER® siehe Seite 832.

Zyklus zur Gewindeherstellung (Beispiel):

Der Gewindeschneidapparat wird mittels Werkzeugwechsler in die Maschinenspindel eingewechselt, dabei rastet der Fixierbolzen in den Arretierblock ein, die Arretierung wird gelöst und der Apparat ist bereit.

Über den Eilvorschub wird die Startposition angefahren. Der Sicherheitsabstand x ist zu berücksichtigen.

Der Arbeitszyklus wird abgefahren. Während des kompletten Vorgangs rotiert die Maschinenspindel rechtsdrehend. Nach Erreichen der programmierten Vorschubtiefe steuert die Z-Achse ohne Verweilzeit auf Rücklauf um. Beim Zusammenspiel zwischen Vorschubumkehr der Z-Achse und dem Zwangsvorschub durch die Steigung des rotierenden Werkzeugs wird der Werkzeugaufnahme-Spannkopf axial aus dem Gewindeschneidapparat gezogen. Dieser Auszug bewirkt das Reversieren der Drehrichtung (Rücklauf). Nach dem Austritt des Werkzeugs aus dem erzeugten Gewinde wird der federbeaufschlagte Werkzeugaufnahme-Spannkopf in seine axiale Ausgangsposition zurückgezogen und das Werkzeug wechselt erneut die Drehrichtung.

Die Maschinenspindel befindet sich in der Startposition.

For the use of our tapping attachments, a stop fixture is needed for the following functions:

For more detailed information regarding technical design of the stop fixture for the SWITCH-MASTER®, see page 832.

Thread production cycle (example):

The tapping attachment is changed into the machine by means of the tool exchanging device, the stop fixture bolt engages in the stop block, the locking device is released and the attachment is ready for operation.

The attachment is moved to start position in the fast-feed mode. The safety distance x must be observed.

The work cycle is performed. During the whole cycle, the machine spindle rotates in a right-hand direction. After reaching the programmed feed depth, the Z-axis switches to reverse without any delay. In the interaction between feed reversal of the Z-axis and the positive feed caused by the pitch of the rotating tool the clamping head of the tool holder is pulled axially from the tapping attachment. This movement operates the change of the sense of rotation (reversal). When the tool has come entirely free from the workpiece the spring-loaded clamping head retracts to its original position, and the sense of rotation of the tool is changed again.

The machine spindle is again in start position.

- Product Finder
- Soft-synchro
- Speed-synchro
- KSN
- MQL MMS
- SFM
- SWITCH-MASTER
- GR, GR-S
- HF
- EM
- Zubehör Accessories
- Tech. Info**

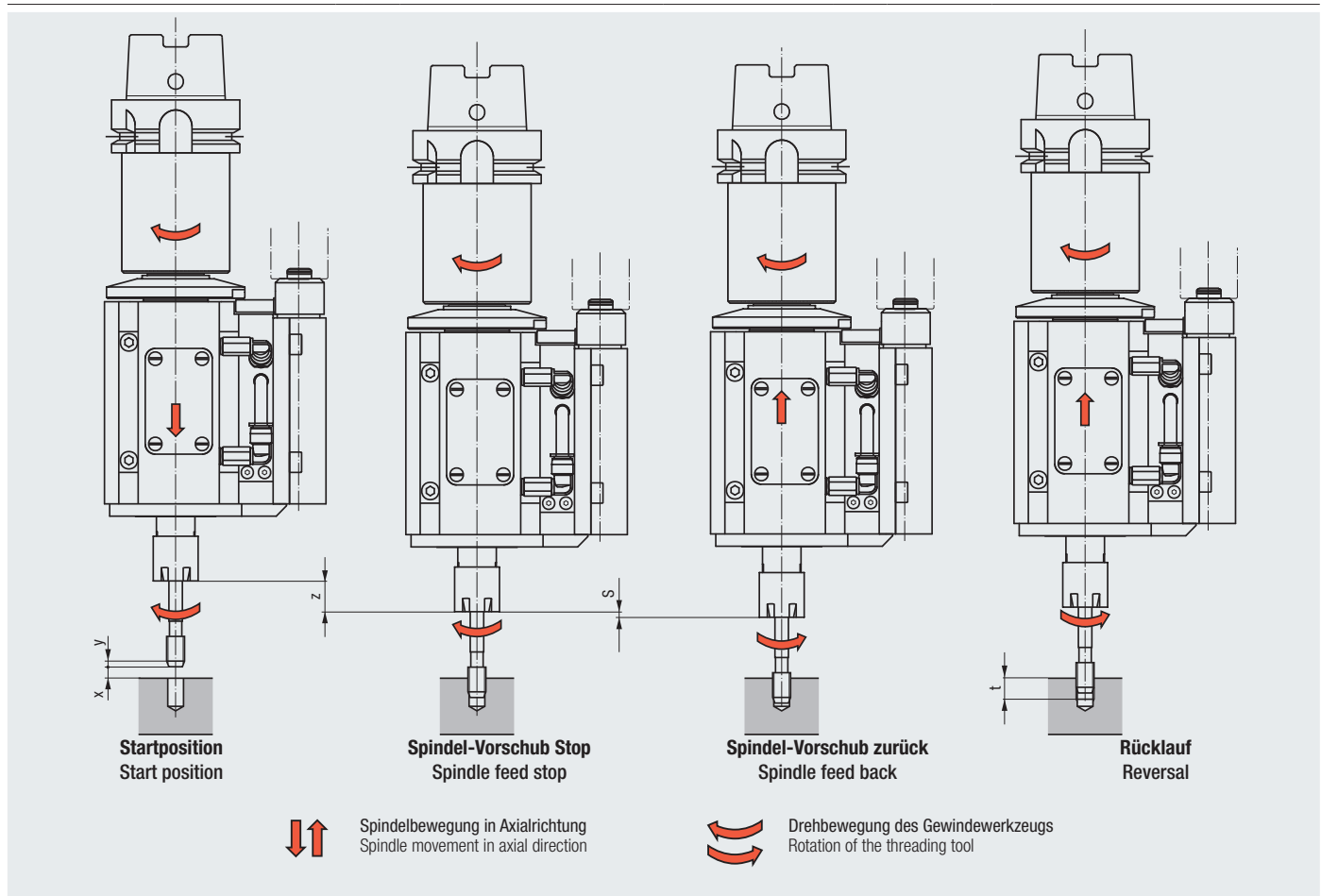

$z = y + x + t - S$

Beispiel des zu programmierenden Verfahrenweges z:

- z = Verfahrenweg
- y = Anschnittlänge des Gewindebohrers bzw. Anformkegellänge des Gewindeformers
- x = Sicherheitsabstand 5 mm
- t = Herzustellende Gewindetiefe
- S = Schaltweg = 3 mm

Example for the travel z to be programmed:

- z = Travel
- y = Chamfer length of tap or lead taper length of cold-forming tap
- x = Safety distance 5 mm
- t = Thread depth to be produced
- S = Gear change path = 3 mm

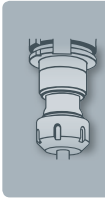

- Product Finder
- Soft-synchro
- Speed-synchro
- KSN
- MQL MMS
- SFM
- SWITCH-MASTER
- GR, GR-S
- HF
- EM
- Zubehör Accessories
- Tech. Info

7.9 Gewindeschneidapparate SWITCH-MASTER®

Auslegung der Transportarretierung für SWITCH-MASTER®

Zum Einsatz des Gewindeschneidapparates ist eine Transportarretierung erforderlich, die folgende Aufgaben übernimmt:

- Abstützung der beim Arbeitseinsatz entstehenden Drehmomente
- Korrekte Positionsbestimmung zwischen Maschinenspindel und Transportarretierung bei Verwendung von automatischen Werkzeugwechslern
- Zuführung der zum Umschalten der Drehrichtung benötigten Hilfsenergie beim Typ SWITCH-MASTER® = Druckluft ($6^{+1}_{-0,5}$ bar)

Die Transportarretierung wird in der Regel vor Auslieferung individuell an die Maschine angepasst.

7.9 Tapping attachments SWITCH-MASTER®

Technical design of the stop fixture for the SWITCH-MASTER®

For the use of our tapping attachments, a stop fixture is needed for the following functions:

- Supporting the torque caused by the operation of the attachment
- Correct definition of the position between machine spindle and stop fixture whenever automatic tool exchange devices are used
- Supply of the auxiliary energy necessary for the change of the sense of rotation on the SWITCH-MASTER® = pressurised air ($6^{+1}_{-0,5}$ bar)

The stop fixture is normally fitted individually to the customer's machine before shipping of the attachment.

Maßangaben zur Transportarretierung Specifications for the stop fixture

Adresse:

Maschinenhersteller/-bezeichnung:

Arretierblock an der Maschine vorhanden?

Ja Nein

Schaftausführung und Größe:

Spindelbezeichnung mit den Anschlussmaßen für die Transportarretierung vorhanden?

Ja (bitte Kopie beilegen)

Nein, Maße: A: B:
E: W:

Address:

Machine manufacturer / designation:

Locking block available on machine?

Yes No

Shank type and size:

Spindle designation with connecting dimensions for stop fixture available?

Yes (please enclose a copy)

No, dimensions: A: B:
E: W:

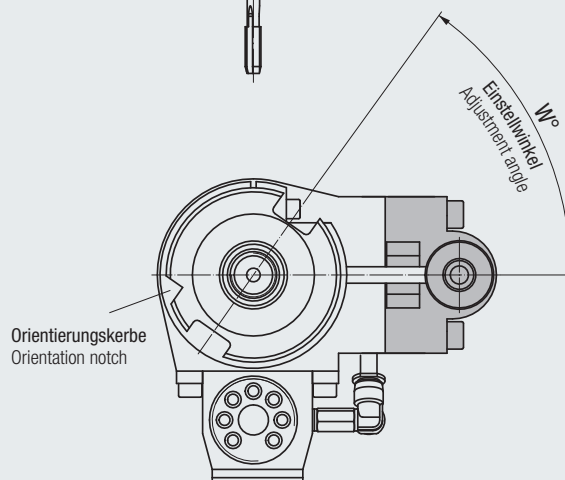
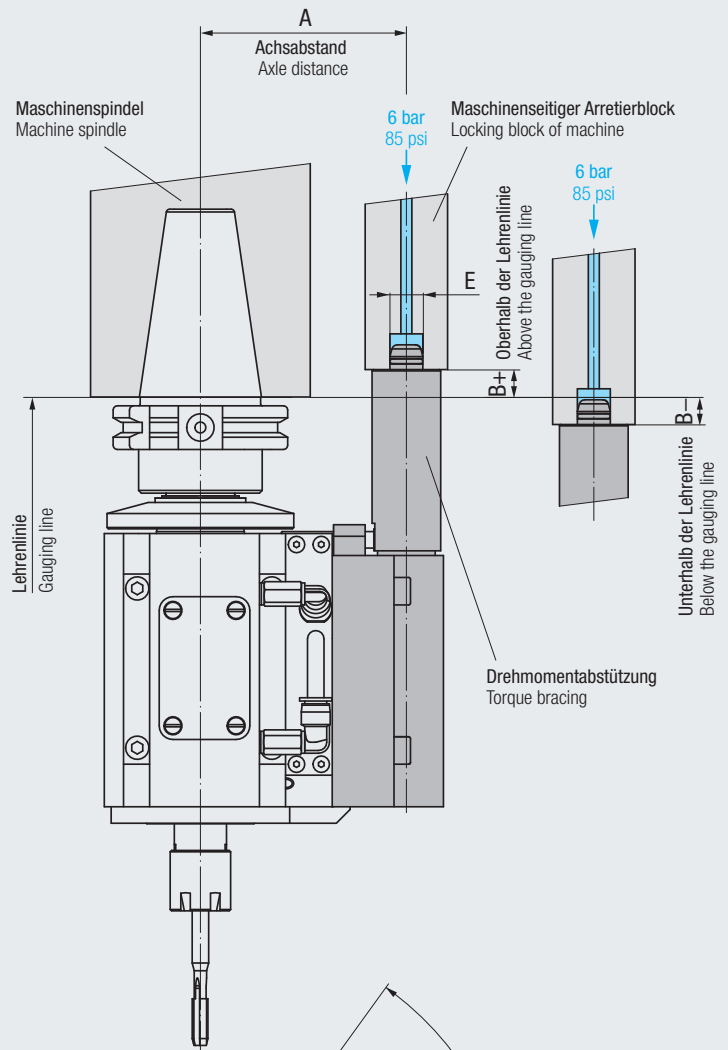

7.10 Einstellen der Überlastkupplung bei Schnellwechsel-Aufnahmen Typ HF

Drehmoment der Überlastkupplung einstellen

Das einzustellende Drehmoment richtet sich u.a. nach der Bearbeitung und dem zu bearbeitenden Werkstoff. Falls das Drehmoment nicht bekannt ist, sollte ein niedriger Wert eingestellt und sich dem richtigen Drehmoment schrittweise angenähert werden.

Achtung:

Die Einstellung darf nicht bei rotierender Maschinenspindel erfolgen!

Benötigte Werkzeuge:

- Innensechskantschlüssel mit Zapfen, Schlüsselweite 10 mm
- Tiefenmesser bzw. Messschieber mit Tiefenmaß

1. Schnellwechsel-Aufnahme in die Maschinenspindel einspannen.

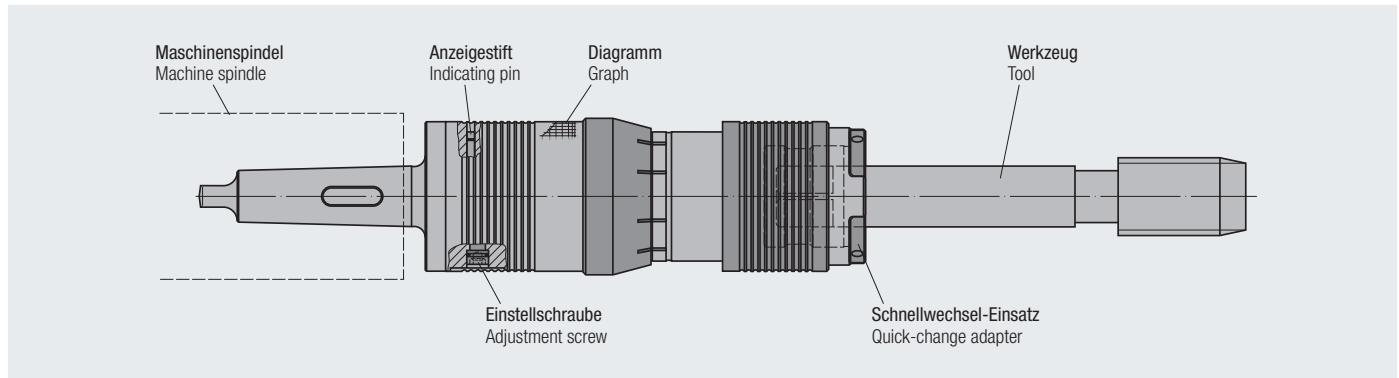

2. Zur Drehmomenteinstellung müssen sich die Markierungsstriche decken. Ist dies nicht der Fall, ist wie folgt vorzugehen:

- Maschine in Betrieb nehmen
- Werkzeug anschneiden lassen
- Maschine stoppen

Achtung:

Vorgang so lange wiederholen, bis sich die Markierungsstriche decken!

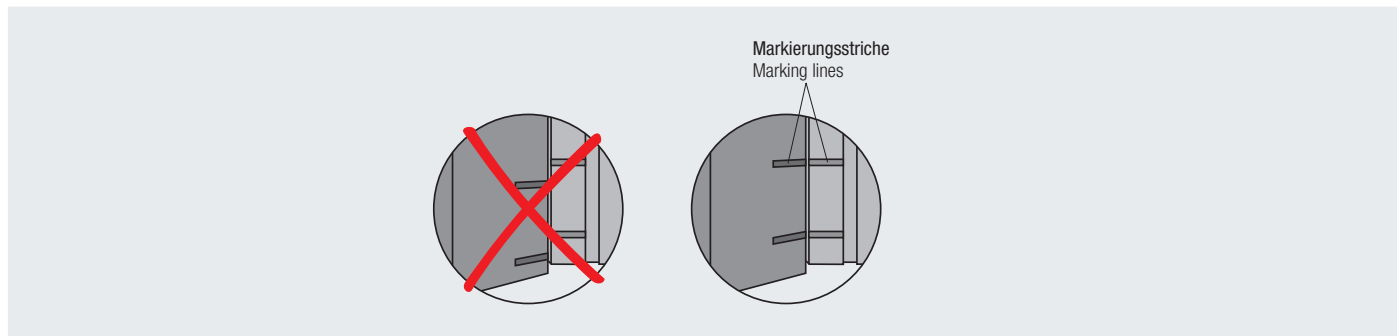

3. Drehmoment einstellen. Hierzu muss die Einstellschraube verdreht werden.

Achtung:

Keine Verlängerung zur Drehmomenteinstellung verwenden!

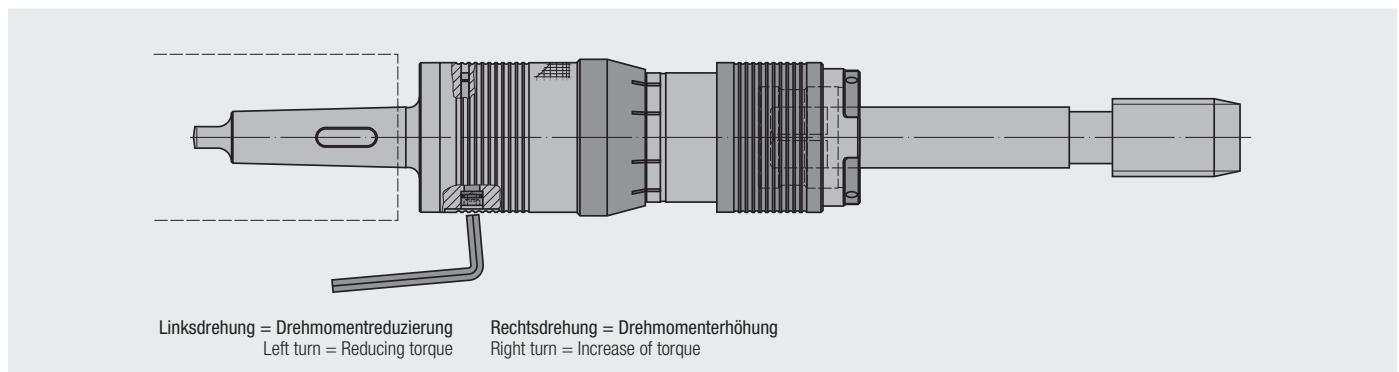

7.10 Adjusting the overload clutch of quick-change tap holders type HF

Adjusting the torque of the overload clutch

The torque to be set depends, among other things, on the type of machining and on the workpiece material to be machined. If the exact torque is not known, we recommend setting a low value first, and approaching the correct torque value step by step.

Attention:

The adjustment must not be carried out while the machine spindle rotates!

Required tools:

- Hexagon socket wrench with pin, width across flats 10 mm
- Depth measurement device or caliper gauge with depth measurement

1. Clamp the quick-change tap holder in the machine spindle.

2. For torque adjustment, the marking rings must coincide. If this is not the case, proceed as follows:

- Put machine into operation
- Let the tool start the cutting process
- Stop machine

Attention:

Repeat this until the marking lines coincide!

3. Adjust torque by turning adjustment screw.

Attention:

Do not use any extension for adjusting the torque!

- Product Finder
- Soft-synchro
- Speed-synchro
- KSN
- MQL MMS
- SFM
- SWITCH-MASTER
- GR, GR-S
- HF
- EM
- Zubehör Accessories
- Tech. Info

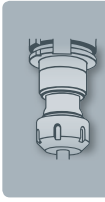

- Product Finder
- Soft-synchro
- Speed-synchro
- KSN
- MQL MMS
- SFM
- SWITCH-MASTER
- GR, GR-S
- HF
- EM
- Zubehör Accessories
- Tech. Info

7.10 Einstellen der Überlastkupplung bei Schnellwechsel-Aufnahmen Typ HF

4. Drehmoment folgendermaßen überprüfen:
- Lage des Anzeigestiftes mit Tiefenmesser messen
 - Drehmoment aus Diagramm ablesen (Diagramm befindet sich auf der Schnellwechsel-Aufnahme)

7.10 Adjusting the overload clutch of quick-change tap holders type HF

4. Check torque by:
- Measuring the position of the indicating pin using the depth measurement device
 - Reading the torque from the graph (the graph is fixed on the quick-change tap holder body)

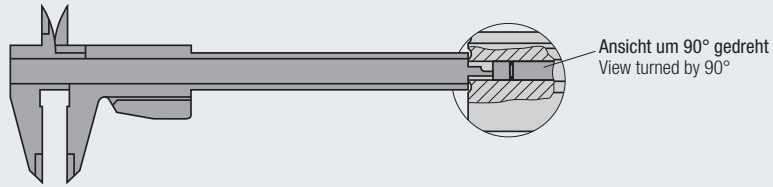

Beispiel: HF 20, Messtiefe 2,7 mm
Von Diagramm abgelesenes Drehmoment: 625 Nm

Example: HF 20, measuring depth 2.7 mm
Torque read from graph: 625 Nm

Das maximale Drehmoment ist eingestellt, wenn der Anzeigestift bündig mit dem Aufnahmedurchmesser ist.

The max. torque is adjusted if the indicating pin matches with the quick-change tap holder diameter.

Drehmomentverlauf

Die nachfolgenden Diagramme sind in ähnlicher Form auf den Schnellwechsel-Aufnahmen im Bereich der Einstelleinheit aufgedruckt.

Torque progression

The following graphs are printed onto the quick-change tap holder near the adjustment unit in similar form.

Drehmomentverlauf für die Schnellwechsel-Aufnahme HF 20

Beispiel: Messtiefe 2,2 mm
Aus Diagramm: 750 Nm Drehmoment eingestellt

Torque progression for the quick-change tap holder HF 20

Example: Measuring depth 2.2 mm
From graph: 750 Nm adjusted torque

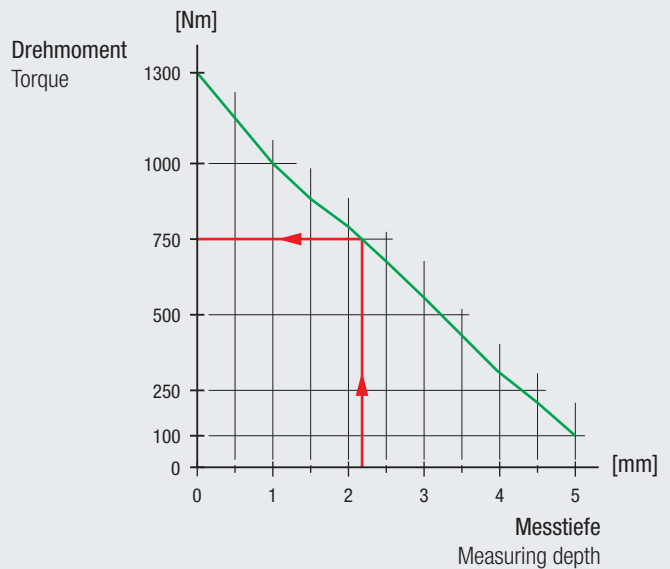

Drehmomentverlauf für die Schnellwechsel-Aufnahme HF 30

Beispiel: Messtiefe 2,75 mm
Aus Diagramm: 2000 Nm Drehmoment eingestellt

Torque progression for the quick-change tap holder HF 30

Example: Measuring depth 2.75 mm
From graph: 2000 Nm adjusted torque

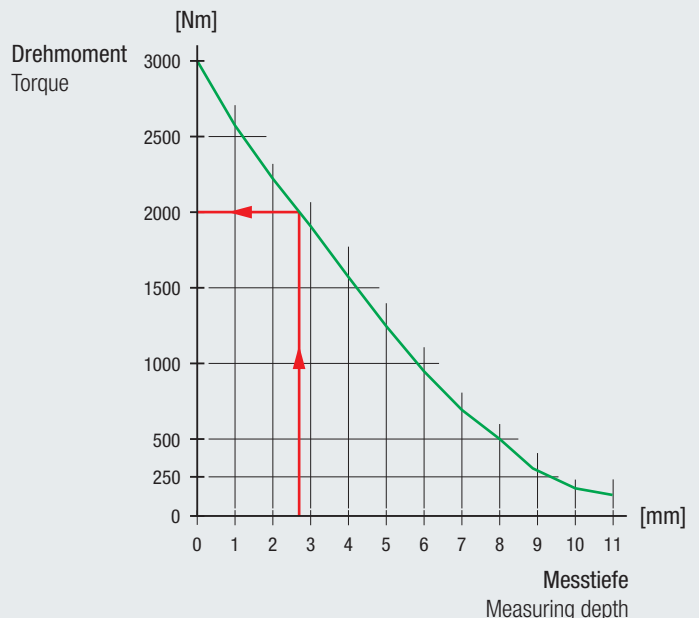

7.11 Reinigung von Spannzangen-Aufnahme und Spannzange Typ PGR

7.11 Cleaning of collet holder and collet type PGR



PGR-Schnittstelle der Spannzangen-Aufnahme reinigen, z.B. mit Hilfe des Kegelreinigers oder eines sauberen, fusselfreien Tuchs.

Clean the PGR interface of the collet holder, e.g. with a taper cleaner or with a clean towel.



PGR-Spannzange entfetten, am besten durch Eintauchen in einer sauberen, fettlösenden und ölfreien Flüssigkeit, z.B. Alkohol oder Kaltreiniger. Zange trocknen. Pressluft nur verwenden, wenn diese sauber und ölfrei ist (keine davorgeschaltete Wartungseinheit).

Degrease PGR collet, dip in a clean, fat-dissolving and oil-free solvent, e.g. alcohol or cleaning solvent. Dry collet. Only use compressed air if it is clean and oil-free (no preceding maintenance unit).



Zange in den Halter einsetzen.

Set collet into tool holder.

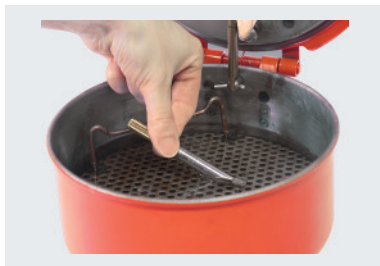

Werkzeugschaft entfetten, am besten durch Eintauchen in einer sauberen, fettlösenden und ölfreien Flüssigkeit, z.B. Alkohol oder Kaltreiniger.

Degrease tool shank by dipping into clean, fat-dissolving and oil-free solvent, e.g. alcohol or cleaning solvent.



Werkzeug in PGR-Spannzange stecken. Bei Verwendung einer Spannzange Typ PGR-GB mit integriertem Vierkant, muss das Werkzeug durch Drehen in die Position gebracht werden, in der es in das Vierkant der Spannzange geschoben werden kann.

Insert tool into the PGR collet. When using a PGR-GB collet with integrated square, the tool must be turned into position in order to be inserted into the square of the collet.

Werkzeug mittels PGR-Spanneinheit einpressen oder Längeneinstellung vornehmen wie unter **7.12 Längeneinstellung von Spannzangen-Aufnahmen Typ PGR** beschrieben.

Press in tool by means of PGR clamping unit, or perform length adjustment as described under **7.12 Length adjustment of collet holders type PGR**.

Product Finder

Soft-synchro

Speed-synchro

KSN

MQL MMS

SFM

SWITCH-MASTER

GR, GR-S

HF

EM

Zubehör Accessories

Tech. Info



- Product Finder
- Soft-synchro
- Speed-synchro
- KSN
- MQL MMS
- SFM
- SWITCH-MASTER
- GR, GR-S
- HF
- EM
- Zubehör Accessories
- Tech. Info**

7.12 Längeneinstellung von Spannzangen-Aufnahmen Typ PGR

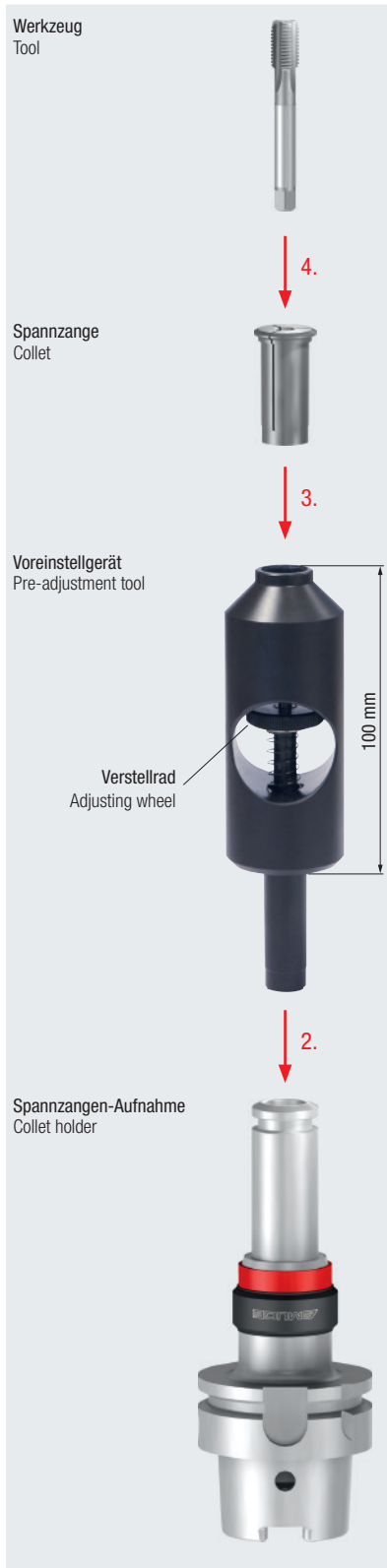

7.12 Length adjustment of collet holders type PGR

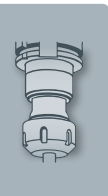

1. Spannzangen-Aufnahme aufnehmen
2. Voreinstellgerät in Spannzangen-Aufnahme einsetzen
3. Spannzange in Voreinstellgerät schieben
4. Werkzeug in Spannzange einsetzen
5. Werkzeuglänge durch Drehen am Verstellrad einstellen
Achtung:
Min./max. Einspannlänge für Werkzeugschäfte beachten
6. Gesamtlänge messen, 100 mm von der mit Voreinstellgerät gemessenen Gesamtlänge abziehen
7. Voreinstellgerät entfernen
8. Werkzeug mittels Spanneinheit einpressen

1. Pick up collet holder
2. Insert pre-adjustment tool in the collet holder
3. Insert collet into pre-adjustment tool
4. Insert tool into collet
5. Adjust tool length by turning the adjusting wheel
Attention:
Observe min./max. clamping length for tool shanks
6. Measure overall length, deduct 100 mm from the overall length measured with pre-adjustment tool
7. Remove pre-adjustment tool
8. Press in tool using the clamping unit





	R _m [N/mm ²]	Rockwell [HRC]							
			Mat.-Nr.	DIN	AFNOR	BS	EN		
P	Automatenstähle · Free-cutting steels								
1.1	> 500		1.0711	9S20	-	220 M 07	-		
1.1	380 - 570		1.0715	9SMn28	S 250	230 M 07	-		
1.1	380 - 570		1.0718	9SMnPb28	S 250 Pb	-	-		
1.1	360 - 530		1.0721	10S20	10 F 1	210 M 15	-		
1.1	360 - 530		1.0722	10SPb20	10 PbF 2	-	-		
1.1	380 - 570		1.0723	15S20	-	210 A 15	-		
1.1	390 - 590		1.0736	9SMn36	S 300	240 M 07	1B		
1.1	390 - 580		1.0737	9SMnPb36	S 300 Pb	-	-		
1.2	580 - 730		1.0726	35S20	35 MF 4	212 M 36	8M		
1.2	660 - 800		1.0727	45S20	45 MF 4	212 M 44	-		
1.2	740 - 880		1.0728	60S20	60 MF 4	-	-		
P	Baustähle legiert · Alloyed construction steels								
1.1	440 - 590		1.5415	15Mo3	15 D 3	1501-240	-		
1.1	450 - 590		1.5423	16Mo5	-	1503-245-420	-		
2.1	490 - 640		1.5622	14Ni6	16 N 6	-	-		
2.1	530 - 710		1.5680	12Ni19	Z 18 N 5	-	-		
2.1	450 - 660		1.7335	13CrMo4-4	15 CD 3.5	1501-620 Gr. 27	-		
2.1	540 - 690		1.7337	16CrMo4-4	15 CD 4.5	1501-620 Gr. 27	-		
2.1	480 - 630		1.7380	10CrMo9-10	10 CD 9.10	1501-622 Gr. 31; 45	-		
3.1	700 - 850		1.7709	21CrMoV5-7	-	-	-		
2.1	490 - 640		1.7715	14MoV6-3	14 Mo 6	1503-660-440	-		
P	Baustähle unlegiert / Unalloyed construction steels								
1.1	> 500		1.0037	St37-2	-	-	-		
1.1	410 - 560		1.0044	St44-2	E 28-2	4360-43 B	-		
1.1	340 - 470		1.0116	St37-3	E 24-3; E 24-4	4360-40 C	-		
1.1	410 - 560		1.0144	St44-3	E 28-3; E 28-4	4360-43 C	-		
2.1	470 - 610		1.0050	St50-2	A 50-2	4360-50 B	-		
2.1	490 - 630		1.0570	St52-3	E 36-3; E 36-4	4360-50 B	-		
2.1	570 - 710		1.0060	St60-2	A 60-2	4360-SSE; SS	-		
1.1	340 - 470		1.0038	RSt37-2	E24-2 Ne	4360 40C	1A		
P	Stahlguss · Steel castings								
2.1	> 380		1.0420	GS-38	-	AM 1	-		
2.1	700 - 800		1.1118	GS-24Mn6	-	-	-		
2.1	480 - 620		1.1120	GS-20Mn5	-	-	-		
2.1	> 500		1.5419	GS-22Mo4	-	245	-		
2.1	> 500		1.5633	GS-24Ni8	-	-	-		
2.1	> 500		1.5681	GS-10Ni19	-	-	-		
2.1	> 500		1.6309	GS-20MnMoNi5-5	-	-	-		
3.1	< 850		1.6582	GS-34CrNiMo6	-	-	24		
3.1	> 800		1.6748	GS-40NiCrMo6-5-6	-	-	-		
3.1	> 800		1.6750	GS-20NiCrMo3-7	-	-	-		
3.1	> 800		1.6760	GS-22NiMoCr5-6	-	-	-		
2.1	490 - 640		1.7357	GS-17CrMo5-5	-	621	-		
2.1	> 500		1.7379	GS-18CrMo9-10	-	622	-		
P	Einsatzstähle / Case-hardening steels								
1.1	< 500		1.0301	C10	AF 34 C 10; XC 10	045 M 10	-		
1.1	< 500		1.0401	C15	AF 34 C 12; XC 18	080 M 15	-		
1.1	< 500		1.0402	C22	CC20	050 A 20	2C		
1.1	< 500		1.1121	CK10	XC 10	045 M 10	-		
1.1	< 500		1.1141	CK15	XC 15; XC 18	080 M 15	32C		
1.1	< 500		1.7012	13Cr2	-	-	-		
2.1	500 - 700		1.7015	15Cr3	12 C 3	523 M 15	-		
2.1	500 - 700		1.5732	14NiCr10	14 NC 11	-	-		
3.1	700 - 850	< 24	1.5752	14NiCr14	12 NC 15	655 M 13	36A		
3.1	700 - 850	< 24	1.5860	14NiCr18	-	-	-		
3.1	700 - 850	< 24	1.5919	15CrNi6	16 NC 6	S 107	-		
3.1	700 - 850	< 24	1.5920	18NiCr8	20 NC 6	-	-		
3.1	700 - 850	< 24	1.6523	21NiCrMo2	20 NCD 2	805 M 20	362		
3.1	700 - 850	< 24	1.6587	17CrNiMo6	18 NCD 6	820 A 16	-		
3.1	700 - 850	< 24	1.7131	16MnCr5	16 MC 5	527 M 17	-		
3.1	700 - 850	< 24	1.7139	16MnCrS5	-	-	-		
3.1	700 - 850	< 24	1.7147	20MnCr5	20 MC 5	-	-		
3.1	700 - 850	< 24	1.7149	20MnCrS5	-	-	-		
3.1	700 - 850	< 24	1.7262	15CrMo5	12 CD 4	-	-		
3.1	700 - 850	< 24	1.7264	20CrMo5	18 CD 4	-	-		
3.1	700 - 850	< 24	1.7271	23CrMoB3-3	-	-	-		
2.1	500 - 700	< 24	1.7311	20CrMo2	-	-	-		
3.1	700 - 850	< 24	1.7321	20MoCr4	-	-	-		
3.1	700 - 850	< 24	1.7323	20MoCrS4	-	-	-		
3.1	700 - 850	< 24	1.7325	25MoCr4	-	-	-		







	UNI	UNE	JIS	SIS	AISI/SAE/ASTM	
						P
	CF 9 S 22	-	SUM 21	-	1212	1.1
	CF 9 SMn 28	11SMn28	SUM 22	1912	1213	1.1
	CF 9 SMnPb 2	11SMnPb28	SUM 22 L	1914	12 L 13	1.1
	CF 10 S 20	10S20	-	-	1108	1.1
	CF 10 SPb 20	10SPb20	-	-	11 L 08	1.1
	-	F.210.F	SUM 32	1922	-	1.1
	CF 9 SMn 36	12SMn36	-	-	1215	1.1
	CF 9 SMnPb 36	12SMnPb36	-	1926	12 L 14	1.1
	-	F210G	-	1957	1140	1.2
	-	-	-	1973	1146	1.2
	-	-	-	-	-	1.2
						P
	16 Mo 3	16Mo3	-	2912	A 204; Gr. A	1.1
	16 Mo 5	16Mo5	-	-	4520	1.1
	14 Ni 6	15Ni6	-	-	A 350-LF 5	2.1
	-	-	-	-	2515	2.1
	14 CrMo 4 5	14CrMo45	-	2216	A 182-F11; F12	2.1
	15 CrMo 4 5	-	-	2216	A 387; Gr. 12 C	2.1
	12 CrMo 9 10	-	-	2218	A 182-F22	2.1
	-	-	-	-	-	3.1
	-	13MoCrV6	-	-	-	2.1
						P
	-	-	STKM 12 C	-	-	1.1
	Fe 430 B FN	-	SM 41 B	1412	A 570; Gr. 40	1.1
	Fe 360 D FF	-	-	1312; 1313	A 573; Gr. 58	1.1
	Fe 430 D FF	-	SM 41 C	1412; 1414	A 573; Gr. 70	1.1
	Fe 490	-	SS 50	2172	A 570; Gr. 50	2.1
	Fe 510 B; C; D	-	SM 50 YA	2132	-	2.1
	Fe 590; Fe 600	-	SM 58	-	-	2.1
	-	-	STKM 12A;C	1311	A570.36	1.1
						P
	-	-	-	-	A 27	2.1
	-	-	-	-	-	2.1
	-	F.8310	-	-	-	2.1
	-	-	SCPH 11	-	-	2.1
	-	-	-	-	-	2.1
	-	-	-	-	A 757	2.1
	-	-	-	-	-	2.1
	-	-	SNCM 9	2541	-	3.1
	-	-	-	-	-	3.1
	-	-	-	-	-	3.1
	-	-	-	-	-	3.1
	-	F-8383	SCPH 21	-	A 217	2.1
	-	-	SCPH 32	-	-	2.1
						P
	C 10	-	S 10 C	-	1010	1.1
	C 15; C 16	F.111	-	1350	1015	1.1
	C20;C21	F.112	-	1450	1020	1.1
	C 10	-	S 10 C; S 9 CK	1265	1010	1.1
	C 15; C 16	C15K	S 15 C; S 15 CK	1370	1015	1.1
	-	-	-	-	-	1.1
	-	-	SCR 415 (H)	-	5015	2.1
	16 NiCr 11	15NiCr11	SNC 415 (H)	-	3415	2.1
	-	-	SNC 815 (H)	-	3310; 9314	3.1
	-	-	-	-	-	3.1
	16 CrNi 4	-	-	-	-	3.1
	-	-	-	-	-	3.1
	20 NiCrMo 2	20NiCrMo2	SNCM 220 (H)	2506	8620	3.1
	18 NiCrMo 7	14NiCrMo13	-	-	-	3.1
	16 MnCr 5	16MnCr5	SCR 415	2511	5115	3.1
	-	-	-	-	-	3.1
	20 MnCr 5	-	SMnC 420 (H)	-	5120	3.1
	-	-	-	-	-	3.1
	12 CrMo 4	F.155	SCM 415 (H)	-	-	3.1
	-	-	SCM 421	-	-	3.1
	-	-	-	-	-	3.1
	-	-	-	-	-	2.1
	-	-	-	-	-	3.1
	-	-	-	-	-	3.1
	-	-	-	-	-	3.1





	R _m [N/mm ²]	Rockwell [HRC]						
			Mat.-Nr.	DIN	AFNOR	BS	EN	
P Federstähle · Spring steels								
3.1	< 850	< 24	1.0904	55Si7	55 S 7	250 A 53	45	
3.1	< 850	< 24	1.0961	60SiCr7	60 SC 7		-	
3.1	< 850	< 24	1.1231	CK67	XC 68	060 A 67		
3.1	< 850	< 24	1.1248	CK75	XC 75	060 A 78		
3.1	< 850	< 24	1.1274	CK101	XC 100	060 A 96		
3.1	< 850	< 24	1.7103	67SiCr5	-	-		
3.1	< 850	< 24	1.7176	55Cr3	55 C 3	527 A 60	48	
3.1	< 850	< 24	1.8159	50CrV4	50 CV 4	735 A 50	47	
3.1	< 850	< 24	1.5026	55 Si 7	55 S 7	250 A 53	-	
P Vergütungsstähle legiert · Alloyed heat-treatable steels								
2.1	< 800	< 21	1.1133	20Mn5	20 M 5	120 M 19	-	
2.1	< 800	< 21	1.7735	14CrMoV6-9	15 CDV 6	-	-	
2.1	< 800	< 21	1.3505	100Cr6	100 C 6	534 A 99	31	
2.1	< 800	< 21	1.5120	38MnSi4	-	-	-	
2.1	< 800	< 21	1.5121	46MnSi4	-	-	-	
2.1	< 800	< 21	1.5141	53MnSi4	-	-	-	
2.1	< 800	< 21	1.5710	36NiCr6	35 NC 6	640 A 35	111A	
2.1	< 800	< 21	1.6546	40NiCrMo2-2	40 NCD 2	311-Type7	-	
2.1	< 800	< 21	1.6565	40NiCrMo6	-	311-Type6	-	
2.1	< 800	< 21	1.7003	38Cr2	38 C 2	-	-	
2.1	< 800	< 21	1.7006	46Cr2	42 C 2	-	-	
2.1	< 800	< 21	1.7020	32Cr2	-	-	-	
2.1	< 800	< 21	1.7030	28Cr4	-	530 A 30	-	
2.1	< 800	< 21	1.7033	34Cr4	32 C 4	530 A 32	18B	
2.1	< 800	< 21	1.7218	25CrMo4	25 CD 4 S	1717 CDS 110	-	
2.1	< 800	< 21	1.7220	34CrMo4	35 CD 4	708 A 37	19B	
2.1	< 800	< 21	1.7223	41CrMo4	42 CD 4 TS	708 M 40	19A	
2.1	< 800	< 21	1.7225	42CrMo4	42 CD 4 TS	708 M 40	19A	
2.1	< 800	< 21	1.7228	50CrMo4	-	708 A 47	-	
3.1	> 800 - 1000	> 21 - 30	1.7182	27MnCrB5-2	-	-	-	
3.1	> 800 - 1000	> 21 - 30	1.5532	38MnB5	-	-	-	
3.1	> 800 - 1000	> 21 - 30	1.1157	40Mn4	35 M 5	150 M 36	15	
3.1	> 800 - 1000	> 21 - 30	1.1165	30Mn5	35 M 5	120 M 36	-	
3.1	> 800 - 1000	> 21 - 30	1.1167	36Mn5	40 M 5	150 M 36	-	
3.1	> 800 - 1000	> 21 - 30	1.1170	28Mn5	20 M 5	150 M 28	14A	
3.1	> 800 - 1000	> 21 - 30	1.3561	44Cr2	-	-	-	
3.1	> 800 - 1000	> 21 - 30	1.3563	43CrMo4	-	-	-	
3.1	> 800 - 1000	> 21 - 30	1.3565	48CrMo4	-	817 M 40	-	
3.1	> 800 - 1000	> 21 - 30	1.5120	38MnSi4	-	-	-	
3.1	> 800 - 1000	> 21 - 30	1.5121	46MnSi4	-	-	-	
3.1	> 800 - 1000	> 21 - 30	1.5122	37MnSi4	-	-	-	
3.1	> 800 - 1000	> 21 - 30	1.5131	50MnSi4	-	-	-	
3.1	> 800 - 1000	> 21 - 30	1.5141	53MnSi4	-	-	-	
3.1	> 800 - 1000	> 21 - 30	1.5223	42MnV7	-	-	-	
3.1	> 800 - 1000	> 21 - 30	1.5710	36NiCr6	35 NC 6	640 A 35	111A	
3.1	> 800 - 1000	> 21 - 30	1.5736	36NiCr10	30 NC 11	-	-	
3.1	> 800 - 1000	> 21 - 30	1.5755	31NiCr14	18 NC 13	653 M 31	-	
3.1	> 800 - 1000	> 21 - 30	1.6511	36CrNiMo4	40 NCD 3	816 M 40	110	
3.1	> 800 - 1000	> 21 - 30	1.6513	28NiCrMo4	-	-	-	
3.1	> 800 - 1000	> 21 - 30	1.7003	38Cr2	38 C 2	-	-	
3.1	> 800 - 1000	> 21 - 30	1.7006	46Cr2	42 C 2	-	-	
3.1	> 800 - 1000	> 21 - 30	1.7030	28Cr4	-	530 A 30	-	
3.1	> 800 - 1000	> 21 - 30	1.7033	34Cr4	32 C 4	530 A 32	18B	
3.1	> 800 - 1000	> 21 - 30	1.7034	37Cr4	38 C 4	530 A 36	-	
3.1	> 800 - 1000	> 21 - 30	1.7035	41Cr4	42 C 4	530 M 40	18	
3.1	> 800 - 1000	> 21 - 30	1.7218	25CrMo4	25 CD 4 S	1717 CDS 110	-	
3.1	> 800 - 1000	> 21 - 30	1.7220	34CrMo4	35 CD 4	708 A 37	19B	
3.1	> 800 - 1000	> 21 - 30	1.7223	41CrMo4	42 CD 4 TS	708 M 40	19A	
3.1	> 800 - 1000	> 21 - 30	1.7225	42CrMo4	42 CD 4 TS	708 M 40	19A	
3.1	> 800 - 1000	> 21 - 30	1.7228	50CrMo4	-	708 A 47	-	
3.1	> 800 - 1000	> 21 - 30	1.7561	42CrV6	-	-	-	
3.1	> 800 - 1000	> 21 - 30	1.7735	14CrMoV6-9	15 CDV 6	-	-	
3.1	> 800 - 1000	> 24 - 30	1.8159	50CrV4	50 CV 4	735 A 50	47	
5.1	> 1000 - 1300	> 30 - 40	1.3563	43CrMo4	-	-	-	
5.1	> 1000 - 1300	> 30 - 40	1.3565	48CrMo4	-	817 M 40	-	
5.1	> 1000 - 1300	> 30 - 40	1.5120	38MnSi4	-	-	-	
5.1	> 1000 - 1300	> 30 - 40	1.5121	46MnSi4	-	-	-	
5.1	> 1000 - 1300	> 30 - 40	1.5122	37MnSi4	-	-	-	
5.1	> 1000 - 1300	> 30 - 40	1.5223	42MnV7	-	-	-	
5.1	> 1000 - 1300	> 30 - 40	1.5710	36NiCr6	35 NC 6	640 A 35	111A	



	 UNI	 UNE	 JIS	 SIS	 AISI/SAE/ASTM	
						P
	55 Si 8	-	-	2085; 2090	9255	3.1
	60 SiCr 8	-	SUP 7	-	9262	3.1
	C 70	-	-	1770	1070	3.1
	C 75	-	-	1774; 1778	1078; 1080	3.1
	-	-	SUP 4	1870	1095	3.1
	-	-	-	-	-	3.1
	55 Cr 3	-	SUP 9 (A)	2253	5155	3.1
	51 CrV 4	51CrV4	SUP 10	2230	6150	3.1
	55 Si 8	-	-	2085; 2090	9255	3.1
						P
	G 22 Mn 3	-	-	-	1022; 1518	2.1
	-	-	-	-	-	2.1
	100 Cr 6	-	SUJ 2	2258	52100	2.1
	-	-	-	-	-	2.1
	-	-	-	-	-	2.1
	-	-	-	-	-	2.1
	-	-	SNC 236	-	3135	2.1
	40 NiCrMo 2 (KB)	40NiCrMo2	SNCM 240	-	8740	2.1
	-	-	SNCM 439	-	4340	2.1
	38 Cr 2	-	-	-	-	2.1
	45 Cr 2	-	-	-	5045	2.1
	-	-	-	-	-	2.1
	-	-	-	-	5130	2.1
	34 Cr 4 (KB)	35Cr4	SCr 430 (H)	-	5132	2.1
	25 CrMo 4 (KB)	55Cr3	SCM 420; SCM 430	2225	4130	2.1
	35 CrMo4	34CrMo4	SCM 432; SCCrM 3	2234	4135; 4137	2.1
	41 CrMo 4	42CrMo4	SCM 440	2244	4142; 4140	2.1
	41 CrMo 4	F-1252	SCM 440	2244	4142; 4140	2.1
	-	-	SCM 445 (H)	-	4150	2.1
	-	-	-	-	-	3.1
	-	-	-	-	-	3.1
	-	-	-	-	1039	3.1
	-	-	SMn 433 H; SCMn 2	-	1330	3.1
	-	-	SMn 438 H; SCMn 3	2120	1335	3.1
	C 28 Mn	-	SCMn 1	-	1330	3.1
	-	-	-	-	-	3.1
	-	-	-	-	-	3.1
	-	-	SNC 836	-	-	3.1
	-	-	-	-	-	3.1
	-	-	-	-	-	3.1
	-	-	-	-	-	3.1
	-	-	-	-	-	3.1
	-	-	-	-	-	3.1
	-	-	SNC 236	-	3135	3.1
	35 NiCr 9	-	SNC 631 (H)	-	3435	3.1
	-	-	SNC 836	-	-	3.1
	38 NiCrMo 4 (KB)	33NiCrMo4	SNC 836	-	9840	3.1
	-	-	-	-	-	3.1
	38 Cr 2	-	-	-	-	3.1
	45 Cr 2	-	-	-	5045	3.1
	-	-	-	-	5130	3.1
	34 Cr 4 (KB)	35Cr4	SCr 430 (H)	-	5132	3.1
	38 Cr 4	-	SCr 435 (H)	-	5135	3.1
	41 Cr 4	42Cr4	SCr 440 (H)	-	5140	3.1
	25 CrMo 4 (KB)	55Cr3	SCM 420; SCM 430	2225	4130	3.1
	35 CrMo4	34CrMo4	SCM 432; SCCrM 3	2234	4135; 4137	3.1
	41 CrMo 4	42CrMo4	SCM 440	2244	4142; 4140	3.1
	41 CrMo 4	F-1252	SCM 440	2244	4142; 4140	3.1
	-	-	SCM 445 (H)	-	4150	3.1
	-	-	-	-	-	3.1
	-	-	-	-	-	3.1
	51 CrV 4	51CrV4	SUP 10	2230	6150	3.1
	-	-	-	-	-	5.1
	-	-	SNC 836	-	-	5.1
	-	-	-	-	-	5.1
	-	-	-	-	-	5.1
	-	-	-	-	-	5.1
	-	-	-	-	-	5.1
	-	-	-	-	-	5.1
	-	-	SNC 236	-	3135	5.1





	R _m [N/mm ²]	Rockwell [HRC]						
			Mat.-Nr.	DIN	AFNOR	BS	EN	
5.1	> 1000 - 1300	> 30 - 40	1.5736	36NiCr10	30 NC 11	-	-	
5.1	> 1000 - 1300	> 30 - 40	1.5864	35NiCr18	-	-	-	
5.1	> 1000 - 1300	> 30 - 40	1.6511	36CrNiMo4	40 NCD 3	816 M 40	110	
5.1	> 1000 - 1300	> 30 - 40	1.6580	30CrNiMo8	30 CND 8	823 M 30	-	
5.1	> 1000 - 1300	> 30 - 40	1.6582	34CrNiMo6	35 NCD 6	817 M 40	24	
5.1	> 1000 - 1300	> 30 - 40	1.7033	34Cr4	32 C 4	530 A 32	18B	
5.1	> 1000 - 1300	> 30 - 40	1.7034	37Cr4	38 C 4	530 A 36	-	
5.1	> 1000 - 1300	> 30 - 40	1.7035	41Cr4	42 C 4	530 M 40	18	
5.1	> 1000 - 1300	> 30 - 40	1.7045	42Cr4	42 C 4 TS	530 A 40	-	
5.1	> 1000 - 1300	> 30 - 40	1.7218	25CrMo4	25 CD 4 S	1717 CDS 110	-	
5.1	> 1000 - 1300	> 30 - 40	1.7220	34CrMo4	35 CD 4	708 A 37	19B	
5.1	> 1000 - 1300	> 30 - 40	1.7223	41CrMo4	42 CD 4 TS	708 M 40	19A	
5.1	> 1000 - 1300	> 30 - 40	1.7225	42CrMo4	42 CD 4 TS	708 M 40	19A	
5.1	> 1000 - 1300	> 30 - 40	1.7228	50CrMo4	-	708 A 47	-	
5.1	> 1000 - 1300	> 30 - 40	1.7361	32CrMo12	30 CD 12	722 M 24	40B	
5.1	> 1000 - 1300	> 30 - 40	1.7561	42CrV6	-	-	-	
5.1	> 1000 - 1300	> 30 - 40	1.7707	30CrMoV9	-	-	-	
5.1	> 1000 - 1300	> 30 - 40	1.7735	14CrMoV6-9	15 CDV 6	-	-	
5.1	> 1000 - 1300	> 30 - 40	1.8159	50CrV4	50 CV 4	735 A 50	47	
5.1	> 1000 - 1300	> 30 - 40	1.8161	58CrV4	-	-	-	
P Vergütungsstähle unlegiert · Unalloyed heat-treatable steels								
2.1	< 800	< 21	1.0402	C22	AF 42 C 20	050 A 20	2D	
2.1	< 800	< 21	1.0406	C25	AF 50 C 30	070 M 26	-	
2.1	< 800	< 21	1.0501	C35	AF 55 C 35	060 A 35	-	
2.1	< 800	< 21	1.0503	C45	AF 65 C 45	080 M 46	-	
2.1	< 800	< 21	1.0511	C40	AF 60 C 40	-	-	
2.1	< 800	< 21	1.0528	C30	-	-	-	
2.1	< 800	< 21	1.1151	Ck22	XC 25; XC 18	050 A 20	-	
2.1	< 800	< 21	1.1158	Ck25	XC 25	070 M 26	-	
2.1	< 800	< 21	1.1178	Ck30	-	-	-	
2.1	< 800	< 21	1.1181	Ck35	XC 38 H1; XC 32	080 M 36	-	
2.1	< 800	< 21	1.1186	Ck40	XC 42 H1	080 M 40	-	
2.1	< 800	< 21	1.1191	Ck45	XC 42	080 M 46	-	
3.1	> 800 - 1000	> 21 - 30	1.0535	C55	-	070 M 55	-	
3.1	> 800 - 1000	> 21 - 30	1.0540	C50	-	-	-	
3.1	> 800 - 1000	> 21 - 30	1.0601	C60	CC 55	080 A 62	43D	
3.1	> 800 - 1000	> 21 - 30	1.1203	Ck55	XC 55	070 M 55	-	
3.1	> 800 - 1000	> 21 - 30	1.1206	Ck50	XC 48 H1	080 M 50	-	
3.1	> 800 - 1000	> 21 - 30	1.1221	Ck60	XC 60	080 A 62	43D	
P Kaltarbeitstähle · Cold work steels								
3.1	760	19	1.2067	100Cr6	Y 100 C 6	BL 3	-	
3.1	760	19	1.2103	58SiCr8	-	-	-	
3.1	760	19	1.2108	90CrSi5	-	-	-	
3.1	720		1.2162	21MnCr5	20 NC 5	-	-	
3.1	730		1.2210	115CrV3	100 C 3	-	-	
3.1	730		1.2330	35CrMo4	34 CD 4	708 A 37	-	
3.1	750		1.2332	47CrMo4	42 CD 4	709 M 40	-	
3.1	760	19	1.2419	105WCr6	105 WC 13	-	-	
3.1	720		1.2510	100MnCrW4	90 MWCV 5	BO 1	-	
3.1	730		1.2516	120W4	110 WC 20	BF 1	-	
3.1	750		1.2542	45WCrV7	-	BS 1	-	
3.1	750		1.2550	60WCrV7	55 WC 20	-	-	
3.1	830	23	1.2721	50NiCr13	-	-	-	
3.1	670		1.2735	15NiCr14	10 NC 12	-	-	
3.1	710		1.2762	75CrMoNiW6-7	-	-	-	
3.1	750		1.2826	60MnSiCr4	-	-	-	
3.1	760	19	1.2833	100V1	Y1 105 V	BW 2	-	
3.1	730		1.2842	90MnCrV8	90 MV 8	BO 2	-	
3.1	830	23	1.2080	X210Cr12	Z 200 C 12	BD 3	-	
3.1	380		1.2341	X6CrMo4	-	-	-	
3.1	760	19	1.2363	X100CrMoV5-1	Z 100 CDV 5	BA 2	-	
3.1	640 - 840		1.5662	X8Ni9	9 Ni	1501.509	-	
3.1	760	19	1.2379	X155CrVMo12-1	Z 160 CDV 12	BD 2	-	
3.1	760	19	1.2436	X210CrW12	-	-	-	
3.1	760	19	1.2601	X165CrMoV12	-	-	-	
P Werkzeugstähle unlegiert · Unalloyed tool steels								
2.1	640		1.1520	C70W1	-	-	-	
2.1	640		1.1525	C80W1	Y1 90; Y1 80	-	-	
2.1	640		1.1545	C105W1	Y1 105	-	-	
2.1	640		1.1620	C70W2	-	-	-	
2.1	640		1.1625	C80W2	Y1 80	BW 1B	-	



UNI	UNE	JIS	SIS	AISI/SAE/ASTM	
35 NiCr 9	-	SNC 631 (H)	-	3435	5.1
-	-	-	-	-	5.1
38 NiCrMo 4 (KB)	33NiCrMo4	SNC 836	-	9840	5.1
30 NiCrMo 8	-	SNCM 431	-	-	5.1
35 NiCrMo 6 (KW)	-	SNCM 447	2541	4340	5.1
34 Cr 4 (KB)	35Cr4	SCr 430 (H)	-	5132	5.1
38 Cr 4	-	SCr 435 (H)	-	5135	5.1
41 Cr 4	42Cr4	SCr 440 (H)	-	5140	5.1
41 Cr 4	42Cr4	SCr 440	2245	5140	5.1
25 CrMo 4 (KB)	55Cr3	SCM 420; SCM 430	2225	4130	5.1
35 CrMo4	34CrMo4	SCM 432; SCCrM 3	2234	4135; 4137	5.1
41 CrMo 4	42CrMo4	SCM 440	2244	4142; 4140	5.1
41 CrMo 4	F-1252	SCM 440	2244	4142; 4140	5.1
-	-	SCM 445 (H)	-	4150	5.1
31 CrMo 12	F.124.A	-	2240	-	5.1
-	-	-	-	-	5.1
-	-	-	-	-	5.1
-	-	-	-	-	5.1
51 CrV 4	51CrV4	SUP 10	2230	6150	5.1
-	-	-	-	-	5.1
					P
C 20; C 21	F.112	-	1450	1020	2.1
C 25	-	-	-	1025	2.1
C 35	F.113	-	1550	1035	2.1
C 45	F.114	-	1650	1045	2.1
C 40	-	-	-	1040	2.1
-	-	-	-	-	2.1
C 20	-	S 20 C; S 20 CK	-	1023	2.1
C 25	-	S 25 C	-	1025	2.1
-	-	-	-	-	2.1
C 35	-	S 35 C	1572	1035	2.1
C 40	-	S 40 C	-	1040	2.1
C 45	C45K	S 45 C	1672	1045	2.1
C 55	-	-	1655	1055	3.1
-	-	-	-	-	3.1
C 60	-	-	-	1060	3.1
C 50	C55K	S 55 C	-	1055	3.1
-	-	-	-	1050	3.1
C 60	-	S 58 C	1665; 1678	1060	3.1
					P
-	100Cr6	-	-	L 3	3.1
-	-	-	-	-	3.1
-	-	-	-	-	3.1
-	-	SCR 420 H	-	-	3.1
107 CrV 3 KU	-	-	-	L 2	3.1
35 CrMo4	-	-	2234	4135	3.1
40 CrMo 4	-	-	2244	4142	3.1
107 Wv 5 KU	105WCr5	SKS 31	-	-	3.1
95 MnWCr 5 KU	-	SKS 3	2140	O 1	3.1
110 W 4 KU	-	-	-	-	3.1
45 WCrV 8 KU	45WCrSi8	-	2710	S 1	3.1
55 WCrV 8 KU	-	-	-	-	3.1
-	-	-	-	-	3.1
-	-	SNC 22	-	-	3.1
-	-	-	-	-	3.1
-	-	-	-	-	3.1
102 V 2 KU	-	SKS 43	-	W 210	3.1
90 MnVCr 8 KU	-	-	-	O 2	3.1
X 210 Cr 13 KU	X210Cr12	SKD 1	-	D 3	3.1
-	-	-	-	-	3.1
X 100 CrMoV 5 1KU	-	SKD 12	2260	A 2	3.1
X 10Ni9	XBNi09	STBL 690	-	A353	3.1
X 155 CrVMo 12 1KU	-	SKD 11	-	D 2	3.1
X 215 CrW 12 1KU	X210CrW12	SKD 2	2312	-	3.1
X 165 CrMoV 12 KU	X160crMoV12	-	2310	-	3.1
					P
-	-	-	-	-	2.1
C 80 KU	-	-	-	W 108	2.1
C 100 KU	-	-	-	W 110	2.1
-	-	-	-	-	2.1
C 80 KU	-	SKC 3; SK 5; SK 6	-	W 1	2.1





	R _m [N/mm ²]	Rockwell [HRC]					EN
			Mat.-Nr.	DIN	AFNOR	BS	
2.1	640		1.1645	C105W2	Y1 105		-
2.1	660		1.1654	C110W	-	-	-
2.1	710		1.1663	C125W	Y2 120		-
2.1	760	19	1.1673	C135W	Y2 140	-	-
2.1	640		1.1730	C45W	Y3 42	-	-
2.1	760	19	1.1740	C60W	Y3 55	-	-
2.1	730		1.1744	C67W	-	-	-
2.1	730		1.1750	C75W	-	BW 1A	-
2.1	570		1.1820	C55W	-	-	-
2.1	750		1.1830	C85W	Y3 90	-	-
P Warmarbeitsstähle · Hot work steels							
2.1	< 770		1.2311	40CrMnMo7	-	-	-
2.1	< 770		1.2312	40CrMnMoS8-6	-	-	-
2.1	< 770		1.2711	54NiCrMoV6	55 NCDV 6	-	-
2.1	< 800		1.2713	55NiCrMoV6	55 NCDV 7	Bh 224	-
2.1	> 800		1.2738	40CrMnNiMo8	-	-	-
3.1	> 840		1.2744	57NiCrMoV7-7	-	-	-
3.1	> 860		1.2764	X19NiCrMo4	-	-	-
3.1	< 870		1.2767	X45NiCrMo4	Y 35 NCD 16	-	-
2.1	< 770		1.2083	X42Cr13	Z 40 C 14	-	-
2.1	< 800		1.2343	X38CrMoV5-1	Z 38 CDV 5	BH 11	-
2.1	< 800		1.2344	X40CrMoV5-1	Z 40 CDV 5	BH 13	-
2.1	< 800		1.2365	X32CrMoV3-3	Z 32 CDV 28	BH 10	-
2.1	< 800		1.2567	X30WCrV5-3	Z 32 WCV 5	-	-
2.1	< 800		1.2581	X30WCrV9-3	Z 30 WCV 9	BH 21	-
2.1	< 770		1.2885	X32CrMoV3-3-3	-	BH 10 A	-
3.1	< 840		1.2316	X36CrMo17	-	-	-
4.1	1080	> 29	Toolox 33	-	-	-	-
4.1	1250	43	Hardox 400	-	-	-	-
5.1	1450	45	Toolox 44	-	-	-	-
P Nitrierstähle · Nitriding steels							
3.1	< 1000	< 30	1.8504	34CrAl6	-	-	-
3.1	< 1000	< 30	1.8506	34CrAlS5	-	-	-
3.1	< 1000	< 30	1.8507	34CrAlMo5	30 CAD 6.12	905 M 31	-
3.1	< 1000	< 30	1.8509	41CrAlMo7	40 CAD 6.12	905 M 39	41B
3.1	> 1000	> 30	1.8515	31CrMo12	30 CD 12	722 M 24	-
3.1	> 1000	> 30	1.8519	31CrMoV9	-	-	-
3.1	> 1000	> 30	1.8521	15CrMoV5-9	-	-	-
3.1	> 1000	> 30	1.8523	39CrMoV13-9	-	897 M 39	40C
3.1	> 1000	> 30	1.8550	34CrAlNi7	-	-	-
M Rost- und säurebeständige Stähle – ferritisch · Corrosion and acid proof steels – ferritic							
1.1	400 - 600		1.4002	X6CrAl13	Z 6 CA 13	405 S 17	-
1.1	380 - 560		1.4512	X5CrTi12	Z 6 CT 12	409 S 19	-
1.1	400 - 600		1.4000	X6Cr13	Z 6 C 13	403 S 17	-
1.1	450 - 600		1.4016	X6Cr17	Z 8 C 17	430 S 15	960
1.1	500 - 700		1.4742	X10CrAlSi18	Z 10 CAS 18	430 S 15	60
1.1	450 - 630		1.4113	X6CrMo17	Z 8 CD 17.01	434 S 17	-
1.1	420 - 600		1.4510	X3CrTi17	Z 8 CT 17	-	-
1.1	400 - 600		1.4521	X2CrMoTi18-2	Z 3 CDT 18-02	-	-
1.1	450 - 650		1.4724	X10CrAlSi13	Z 13 C 13	-	-
1.1	520 - 720		1.4762	X10CrAl24	Z 10 CAS 24	-	-
M Rost- und säurebeständige Stähle – austenitisch · Corrosion and acid proof steels – austenitic							
2.1	750 - 950		1.4372	X12CrMnNiN17-7-5	Z 12 CMN 17-07 Az	-	-
2.1	680 - 880		1.4373	X12CrMnNiN18-9-5	-	284 S 16	-
2.1	600 - 950		1.4310	X10CrNi18-8, X12CrNi17-7	Z 11 CN 17-08	301 S 21	-
2.1	630 - 850		1.4318	X2CrNi18-7	Z 3 CN 18-07 Az	-	-
2.1	500 - 700		1.4305	X10CrNiS18-9	Z 10 CNF 18.09	303 S 21	58M
2.1	600 - 951		1.4350	X5CrNi18-9	Z 6 CN 18.09	304 S 31	58E
2.1	520 - 720		1.4301	X5CrNi18-9	Z 6 CN 18.09	304 S 15	58E
2.1	460 - 680		1.4306	X2CrNi19-11	Z 2 CN 18.10	304 S 12	-
2.1	550 - 750		1.4311	X2CrNi18-10	Z 2 CN 18.10	304 S 62	-
2.1	510 - 710		1.4948	X6CrNi18-11	-	304 S 50	-
2.1	520 - 700		1.4307	X2CrNi18-9	Z 2 CN 19-09	-	-
2.1	500 - 750		1.4315	X5CrNi19-9	-	-	-
2.1	500 - 650		1.4303	X5CrNi18-12	Z 8 CN 18.12	305 S 19	-
2.1	500 - 700		1.4833	X12CrNi23-13	Z 15 CN 23-13	309 S 24	-
2.1	500 - 700		1.4845	X8CrNi25-21	Z 8 CN 25-20	310 S 24	-
2.1	550 - 750		1.4841	X15CrNiSi25-21	Z 15 CNS 25-20	314 S 25	-
2.1	520 - 680		1.4401	X5CrNiMo18-10	Z 6 CND 17.11	316 S 16	58J
2.1	530 - 730		1.4436	X5CrNiMo17-13-3	Z 6 CND 17.12	316 S 16	-
2.1	520 - 680		1.4404	X2CrNiMo17-13-2	Z 2 CND 17.12	316 S 11	-



UNI	UNE	JIS	SIS	AISI/SAE/ASTM	
C 100 KU	-	SK 3	-	-	2.1
-	-	-	-	-	2.1
C 120 KU	-	SK 2	-	W 112	2.1
C 140 KU	-	SK 1	-	-	2.1
-	-	-	-	-	2.1
-	-	SK 7	-	-	2.1
-	-	-	-	-	2.1
-	-	-	-	W 1	2.1
-	-	-	-	-	2.1
-	-	SK 5	-	-	2.1
					P
35 CrMo8	-	-	-	-	2.1
40 CrMnMo 7	F-5302	-	-	-	2.1
-	-	-	-	-	2.1
-	F.520.S	SKT 4	-	L 6	2.1
-	-	-	-	P20	2.1
-	-	-	-	-	3.1
-	-	-	-	-	3.1
42 NiCrMo 15 7	-	-	-	-	3.1
X 41 Cr 13 KU	F-5263	SUS 420 J 2	-	-	2.1
X 37 CrMoV 5 1 KU	F-5317	SKD 6	-	H 11	2.1
X 40 CrMoV 5 1 1 KU	F-5318	SKD 61	-	H 13	2.1
X 30 CrMoV 12 27 KU	F-5313	SKD 7	-	H 10	2.1
X 30 WCrV 5 3 KU	-	SKD 4	-	-	2.1
X 30 WCrV 9 3 KU	X30WCrV9	SKD 5	-	H 21	2.1
-	F-5314	-	-	-	2.1
X 38 CrMo 16 1 KU	F-5267	-	-	-	3.1
-	-	-	-	Toolox 33	4.1
-	-	-	-	Hardox 400	4.1
-	-	-	-	Toolox 44	5.1
					P
-	-	-	-	-	3.1
-	-	-	-	-	3.1
34 CrAlMo 7	-	-	-	A 355 Cl. D	3.1
41 CrAlMo 7	41CrAlMo7	SACM 645	2940	A 355 Cl. A	3.1
31 CrMo 12	-	-	2240	-	3.1
-	-	-	-	-	3.1
-	-	-	-	-	3.1
39 CrMoV 13 9	-	-	-	-	3.1
-	-	-	-	-	3.1
					M
X 6 CrAl 13	-	SUS 405	2302	405	1.1
X 6 CrTi 12	-	SUH 409	-	409	1.1
X 6 Cr 13	F.3110	SUS 403	2301	403	1.1
X 8 Cr 17	F.3113	SUS 430	2320	430	1.1
X 8 Cr 17	F-3153	SUS 430; SUH 21	-	430	1.1
X 8 CrMo 17	F.3116	SUS 434	2325	434	1.1
X 6 CrTi 17	-	SUS 430 LX	-	XM 8; 430 Ti	1.1
-	F-3123	SUS 444	2326	444	1.1
-	F-3152	-	-	-	1.1
X 16 Cr 26	F.3154	SUH 446	-	446	1.1
					M
-	-	-	-	201	2.1
-	-	-	-	202	2.1
X10CrNi18-8	F-3517	SUS 301	2331	301	2.1
-	-	-	-	301LN	2.1
X 10 CrNi 18 9	F.3508	SUS 303	2346	303	2.1
X 5 CrNi 18 10	F.3551	SUS 302	-	304	2.1
X 5 CrNi 18 10	F.3551	SUS 304	2332; 2333	304; 304 H	2.1
X 2 CrNi 18 11	F.3503	SCS 19	2352; 2333	304 L	2.1
X 2 CrNiN 18 11	-	SUS 304 LN	2371	304 LN	2.1
-	-	-	-	304H	2.1
-	-	-	-	304 L	2.1
-	-	-	-	304 N	2.1
X 8 CrNi 19 10	-	SUS 305	-	308; 305	2.1
X 6 CrNi 23 14	-	SUS 309S	-	309 S	2.1
X 6 CrNi 25 20	F.331	SUS 310S	2361	310 S	2.1
-	F.3310	SUH 310	-	314	2.1
X 5 CrNiMo 17 12	F.3543	SUS 316	2347	316	2.1
X 5 CrNiMo 17 13	F.3538	SUS 316	2343	316	2.1
X 2 CrNiMo 17 12	F.3533	SUS 316 L	2348	316 L	2.1



	R _m [N/mm ²]	Rockwell [HRC]					EN
			Mat.-Nr.	DIN	AFNOR	BS	
2.1	520 - 700		1.4435	X2CrNiMo18-14-3	Z 2 CND 17.13	317 S 12	-
2.1	520 - 700		1.4432	X2CrNiMo17-12-3	Z 3 CND 17-02-03	316 S 13	-
2.1	580 - 780		1.4406	X2CrNiMoN17-12-2	Z 2 CND 17.12 AZ	316 S 61	58C
2.1	580 - 780		1.4429	X2CrNiMoN17-13-3	Z 2 CND 17.13 AZ	316 S 62	-
2.1	490 - 740		1.4573	X10CrNiMoTi18-12	-	320 S 33	-
2.1	520 - 690		1.4571	X6CrNiMoTi17-12-2	Z 6 CNT 17.12	320 S 31	58J
2.1	520 - 720		1.4580	X6CrNiMoNb17-12-2	Z 6 CNDNb 17.12	318 S 17	-
2.1	550 - 700		1.4438	X2CrNiMo18-16-4	Z 2 CND 19.15	317 S 12	-
2.1	580 - 780		1.4439	X2CrNiMoN17-13-5	Z 3 CND 18-14-05 Az	-	-
2.1	490 - 740		1.4583	X10CrNiMoNb18-12	-	-	-
2.1	500 - 720		1.4541	X6CrNiTi18-10	Z 6 CNT 18.10	321 S 12	58B
2.1	500 - 720		1.4878	X8CrNiTi18-10	Z 6 CNT 18-10	321 S 31	-
2.1	500 - 720		1.4550	X6CrNiNb18-10	Z 6 CNNb 18.10	347 S 17	58F
2.1	500 - 700		1.4563	X1NiCrMoCu31-27-4	Z 2 NCDU 31-27	-	-
2.1	520 - 730		1.4539	X1NiCrMoCu25-20-5	Z 2 NCDU 25-20	904 S 13	-
2.1	550 - 750		1.4864	X12NiCrSi35-16	Z 20 NCS 33-16	NA 17	-
2.1	620 - 880		1.4460	X8CrNiMo27-5	Z 5 CND 27-05	-	-
2.1	500 - 740		1.4546	X5CrNiNb18-10	Z 6 CNNb 18.10	347 S 18	58F
M	Rost- und säurebeständige Stähle – Duplex · Corrosion and acid proof steels – Duplex						
3.1	340 - 950		1.4462	X2CrNiMoN22-5-3	Z 3 CND 22-05 Az	318 S 13	-
3.1	630 - 850		1.4362	X2CrNiN23-4	Z 3 CN 23-04 Az	-	-
4.1	730 - 1250		1.4410	X2CrNiMoN25-7-4	Z 3 CND 25-06	-	-
3.1	730 - 1000		1.4507	X2CrNiMoCuN25-6-3	Z 3 CNDU 25-06	-	-
3.1	730 - 1000		1.4507	X2CrNiMoCuN25-6-3	Z 3 CNDU 25-06	-	-
M	Rost- und säurebeständige Stähle – martensitisch · Corrosion and acid proof steels – martensitic						
1.1	> 600		1.4006	X10Cr13	Z 12 C 13	410 S 21	56A
1.1	650 - 850		1.4005	X12CrS13	Z 12 CF 13	416 S 21	-
1.1	> 700		1.4021	X20Cr13	Z 20 C 13	420 S 37	-
1.1	> 740		1.4028	X30Cr13	Z 30 C 13	420 S 45	-
1.1	> 760		1.4031	X38Cr13	Z 40 C 14	-	-
1.1	> 780		1.4034	X46Cr13	Z 40 CM	420 S 45	56D
1.1	> 850		1.4116	X50CrMoV15	Z 50 CD 15	-	-
1.1	> 900		1.4122	X39CrMo17-1	Z 38 CD 16-01	-	-
3.1	780 - 980		1.4313	X5CrNi134	Z 5 CN 13.4	425 C 11	-
3.1	840 - 1000		1.4418	X4CrNiMo6-5-1	Z 6 CND 16-05-01	-	-
1.1	> 650		1.4024	X15Cr13	Z 12 C 13 M	420 S 29	56B
1.1	640 - 840		1.4104	X14CrMoS17	Z 13 CF 17	-	-
1.1	750 - 950		1.4057	X17CrNi162	Z 15 CN 16.02	431 S 29	57
1.1			1.4747	X80CrNiSi20	Z 80 CSN 20.02	443 S 65	59
1.1	< 900		1.4125	X105CrMo17	Z 100 CD 17	-	-
M	Rost- und säurebeständige Stähle – ausscheidungshärtend · Corrosion and acid proof steels – precipitation-hardened						
4.1	> 1275		1.4542	X5CrNiCuNb16-4	Z 7 CNU 15-05	-	-
3.1	> 1030		1.4568	X7CrNiAl17-7	Z 9 CNA 17-07	301 S 81	-
K	Gusseisen mit Lamellengrafit (GJL) · Cast iron with lamellar graphite (GJL)						
1.1	100 - 200		0.6010	EN-GJL100 (GG10)	Ft 10 D	-	-
1.1	150 - 250		0.6015	EN-GJL150 (GG15)	Ft 15 D	Grade 150	-
1.2	200 - 300		0.6020	EN-GJL200 (GG20)	Ft 20 D	Grade 220	-
1.2	250 - 350		0.6025	EN-GJL250 (GG25)	Ft 25 D	Grade 260	-
1.2	300 - 400		0.6030	EN-GJL300 (GG30)	Ft 30 D	Grade 300	-
1.2	350 - 450		0.6035	EN-GJL350 (GG35)	Ft 35 D	Grade 350	-
1.2	400 - 500		0.6040	EN-GJLZ (GG40)	Ft 40 D	Grade 400	-
1.1	> 170		0.6655	GGL-NiCuCr15-6-2	L-NUC 15 6 2	L-NUC 15 6 2	-
1.1	> 170		0.6660	GGL-NiCr20-2	L-NC 20 2	L-NC 20 2	-
1.1	> 190		0.6676	GGL-NiCr30-3	L-NC 30 3	L-NC 30 3	-
1.1	> 170		0.6680	GGL-NiSiCr30-5-5	L-NSC 30 5 5	L-NSC 30 5 5	-
K	Gusseisen mit Kugelgrafit (GJS) · Cast iron with nodular graphite (GJS)						
2.1	370 - 400		0.7040	EN-GJS-400-15 (GGG40)	FGS 400-12	SNG 420/12	-
2.1	420 - 500		0.7050	EN-GJS-500-7 (GGG50)	FGS 500-7	SNG 500/7	-
2.2	550 - 600		0.7060	EN-GJS-600-3 (GGG60)	FGS 600-3	SNG 600/3	-
2.2	660 - 700		0.7070	EN-GJS-700-2 (GGG70)	FGS 700-2	SNG 700/2	-
2.2	800		0.7080	EN-GJS-800-2 (GGG80)	FGS 800-2	SNG 800/2	-
2.1	370 - 480		0.7660	GGG-NiCr20-2	S-NC 20 2	S-NiCr 20 2	-
2.1	> 390		0.7661	GGG-NiCr20-3	S-NC 20 3	S-NiCr 20 3	-
2.1	370 - 450		0.7670	EN-GJSA-XNi22	S-N 22	S-Ni 22	-
2.1	440 - 480		0.7673	EN-GJSA-XNiMn23-4	S-NM 23 4	S-NiMn 23 4	-
2.1	370 - 480		0.7676	EN-GJSA-XNiCr30-3	S-NC 30 3	S-NiCr 30 3	-
2.1	> 370		0.7677	GGG-NiCr301	S-NC 30 1	S-NiCr 30 1	-
2.1	390 - 500		0.7680	EN-GJSA-XNiSiCr30-5-5	S-NSC 30 5 5	S-NiSiCr 30 5 5	-
2.1	370 - 420		0.7683	EN-GJSA-XNi35	S-N 35	S-Ni 35	-
2.1	370 - 450		0.7685	EN-GJSA-XNiCr35-3	S-NC 35 3	S-NiCr 35 3	-



UNI	UNE	JIS	SIS	AISI/SAE/ASTM	
X 2 CrNiMo 17 13	-	SCS 16; SUS 316 L	2353	316 L	2.1
X 2 CrNiMo 17-12-3	F-3537	-	-	316 L	2.1
X 2 CrNiMoN 17 12	F-3542	SUS 316 LN	-	316 LN	2.1
X 2 CrNiMoN 17 13	F-3543	SUS 316 LN	2375	316 LN	2.1
X 6 CrNiMoTi 17 13	-	SUS 316 Ti	-	316 Ti	2.1
X 6 CrNiMoTi 17 12	F.3535	SUS 316 Ti	2350	316 Ti	2.1
X 6 CrNiMoNb 17 12	F.3536	-	-	316 Cb	2.1
X 2 CrNiMo 18 15	F-3539	SUS 317 L	2367	317 L	2.1
-	F-3544	-	-	317 LMN	2.1
X 6 CrNiMoNb 17 13	-	-	-	318	2.1
X 6 CrNiTi 18 11	F.3553; F.3523	SUS 321	2337	321	2.1
-	-	SUS 321	-	321 H	2.1
X 6 CrNiNb 18 11	F.3552; F.3524	SUS 347	2338	347	2.1
-	-	-	2584	B 668	2.1
-	-	-	2562	904 L	2.1
-	F.3313	SUH 330	-	330	2.1
-	F-35552	SUS 329 J 1	2324	329	2.1
X 6 CrNiNb 18 11	F-3524	SUS 347	2338	348	2.1
M					
-	-	SUS 329J3L	2377	2205	3.1
-	-	-	2327	2304	3.1
-	-	SCS 14A	2328	2507	4.1
-	-	-	-	255	3.1
-	-	-	-	255	3.1
M					
X 12 Cr 13	F.3401	SUS 410	2302	410; CA-15	1.1
X 12 CrS 13	-	SUS 416	2380	416	1.1
X 20 Cr 13	-	SUS 420 J 1	2303	420	1.1
X 30 Cr 13	-	SUS 420 J 2	2304	420	1.1
X 40 Cr 14	-	SUS 420 J 2	2304	420	1.1
X 40 Cr 14	F.3405	SUS 420 J 2	2304	420	1.1
-	F-3422	-	-	-	1.1
-	-	-	-	-	1.1
X 6 CrNi 13 04	-	SCS 5	2385	CA 6-NM	3.1
-	-	-	2387	-	3.1
-	-	SUS 410J1	-	420	1.1
X 14 CrS 17	F-3431	SUS 430 F	2383	430 F	1.1
X 16 CrNi 16	F-3427	SUS 431	2321	431	1.1
X 80 CrSiNi 20	F.320.B	SUH 4	-	HNW 6	1.1
X 105 CrMo 17	-	SUS 440 C	-	440 C	1.1
M					
-	-	SCS 630	-	630	4.1
-	-	SUS 631	2388	631	3.1
K					
G 10	-	FC 10	01 10-00	A48-20 B	1.1
G 15	FG 15	FC 15	01 15-00	A48-25 B	1.1
G 20	FG 20	FC 20	01 200	A48-30 B	1.2
G 25	FG 25	FC 25	01 250	A48-40 B	1.2
G 30	FG 30	FC 30	1 300	A48-45 B	1.2
G 35	FG 35	FC 35	1 350	A48-50 B	1.2
-	-	-	1 400	A48-60 B	1.2
-	-	-	-	A-436 Type 1	1.1
-	-	-	-	A-436 Type 2	1.1
-	-	-	-	A-436 Type 3	1.1
-	-	-	-	A-436 Type 4	1.1
K					
GS 400-12	GGG 40	FCD 40	0717-02	60-40-18	2.1
GS 500/7	GGG 50	FCD 50	0727-02	65-45-12	2.1
GS 600/3	-	FCD 60	0732-03	80-55-06	2.2
GS 700/2	GGG 70	FCD 70	0737-01	100-70-03	2.2
GS 800/2	-	-	-	120-90-02	2.2
-	F 43000	-	-	A 439 Type D-2	2.1
-	F 43001	-	-	A 439 Type D-2B	2.1
-	F 43002	-	-	A 439 Type D-2C	2.1
-	F 43003	-	-	A 439 Type D-2M	2.1
-	-	-	-	A 439 Type D-3	2.1
-	F 43004	-	-	A 439 Type D-3A	2.1
-	F 43005	-	-	A 439 Type D-4	2.1
-	F 43006	-	-	A 439 Type D-5	2.1
-	-	-	-	A 439 Type D-5B	2.1





	R _m [N/mm ²]	Rockwell [HRC]	Mat.-Nr.	DIN	AFNOR	BS	EN
K Gusseisen mit Vermiculargrafit (GJV) · Cast iron with vermicular graphite (GJV)							
3.1	300-375			EN-GJV300	-	-	-
3.2	350-425			EN-GJV350	-	-	-
3.2	400-475			EN-GJV400	-	-	-
3.2	450-525			EN-GJV450	-	-	-
3.2	500-575			EN-GJV500	-	-	-
K Temperguss (GTMW, GTMB) · Malleable cast iron (GTMW, GTMB)							
4.1	> 350		0.8135	EN-GJMB-350-10	MN35-10	B340/12	-
4.1	> 450		0.8145	EN-GJMB-450-6	-	P440/7	-
4.2	> 550		0.8155	EN-GJMB-550-4	MP50-5	P510/4	-
4.2	> 650		0.8165	EN-GJMB-650-2	MP60-3	P570/3	-
4.2	> 700		0.8170	EN-GJMB-700-2	M870-2	P690/2	-
4.1	270 - 360		0.8035	EN-GJMW-350-4	MB35-7	W340/3	-
4.1	300 - 420		0.8040	EN-GJMW-400-5	MB40-10	W410/4	-
4.1	330 - 480		0.8045	EN-GJMW-450-7	-	-	-
4.2	490 - 570		0.8055	EN-GJMW-550-4	-	-	-
N Aluminium unlegiert · Unalloyed aluminium							
1.1	65 - 150		3.0225	Al99.5	A5	1B	-
1.1	40 - 100		3.0305	Al99.9	A9	-	-
N Aluminium-Knetlegierungen, nicht ausgehärtet · Wrought aluminium alloys, not hardened							
1.1	100 - 125		3.0505	AlMn0.5Mg0.5	-	N31	-
1.2	80 - 230		3.0515	AlMn1	-	N3	-
1.2	115 - 290		3.0525	AlMn1Mg0.5	A-M1G0,5	-	-
1.1	100 - 205		3.3315	AlMg1	A-G0,6	N41	-
1.2	180 - 310		3.3535	AlMg3	A-G3M	N5	-
N Aluminium Knetlegierungen, ausgehärtet · Wrought aluminium alloys, hardened							
1.3	150 - 400		3.1325	AlCuMg1	A-U4G	H14	-
1.3	180 - 460		3.1355	AlCuMg2	A-U4G1	2L97	-
1.3	130 - 360		3.2315	AlMgSi1	A-SGM0,7	H30	-
1.2	130 - 270		3.3206	AlMgSi0.5	-	H9	-
1.2	120 - 300		3.3211	AlMg1SiCu	-	H20	-
1.3	410 - 490		3.4345	AlZnMgCu0.5	AZ 4 GU/9051	L86	-
1.3	180 - 560		3.4365	AlZnMgCu1.5	AZ 4 GU/9050 C	L87	-
N Aluminium-Gusslegierungen Si ≤ 7% · Aluminium cast alloys Si ≤ 7%							
1.4	280 - 300		3.2134	G-AlSi5Cu1Mg	-	-	-
1.4	140 - 300		3.3241	G-AlMg3Si	-	-	-
1.4	200		3.3292	GD-AlMg9	A-G10S	-	-
1.4	140 - 210		3.3541	GD-AlMg3	A-G3T	-	-
N Aluminium-Gusslegierungen 7% < Si ≤ 12% · Aluminium cast alloys 7% < Si ≤ 12%							
1.5	160 - 200		3.2161	G-AlSi8Cu3	-	-	-
1.5	230 - 360		3.2373	G-AlSi9Mg	A-S9G	-	-
1.5	240 - 350		3.2163	G-AlSi9Cu3	A-S9U3	LM24	-
1.5	150 - 340		3.2381	G-AlSi10Mg	A-S10G	LM9	-
1.5	160		3.2383	G-AlSi10Mg(Cu)	A-S10GU	LM 9	-
1.5	150 - 170		3.2581	G-AlSi12	A-S13	LM 6	-
1.5	150 - 290		3.2583	G-AlSi12(Cu)	A-S12U	LM 20	-
N Aluminium-Gusslegierungen Si > 12% · Aluminium cast alloys Si > 12%							
1.6	165 - 370			G-AlSi17Cu4Mg	-	-	-
1.6	180 - 220			G-AlSi18CuNiMg	-	-	-
1.6	200 - 240			G-AlSi21CuNiMg	-	-	-
1.6	230 - 300			G-AlSi25CuNiMg	-	-	-
N Reinkupfer, niedriglegiertes Kupfer · Pure copper, low-alloyed copper							
2.2	< 600		2.0240	CuZn15	CuZn15	CZ 102	-
2.2	< 800		2.0265	CuZn30	CuZn30	CZ 106	-
N Kupfer-Zink-Legierungen (Messing, langspanend) · Copper-zinc alloys (brass, long-chipping)							
2.2	< 800		2.0321	CuZn37	CuZn37	CZ 108	-
2.2	< 800		2.0335	CuZn36	Ms63	CZ 108	-
2.2	340 - 480		2.0360	CuZn40	Ms60	DCB1	-
N Kupfer-Zink-Legierungen (Messing, kurzspanend) · Copper-zinc alloys (brass, short-chipping)							
2.3	340 - 570		2.0401	CuZn39Pb3	Ms58	-	-
N Kupfer-Zinn-Legierungen (Zinnbronze, langspanend) · Copper-tin alloys (tin bronze, long-chipping)							
2.5	< 900		2.1016	CuSn4	-	-	-
2.5	390 - 620		2.1030	CuSn8P	-	-	-
N Kupfer-Zinn-Legierungen (Zinnbronze, kurzspanend) · Copper-tin alloys (tin bronze, short-chipping)							
2.6	200 - 250		2.1097	G-CuSn5ZnPb	Rg5	-	-
2.6	230 - 320		2.1090.01	G-CuSn7ZnPb	Rg7	-	-
2.6	280		2.1086.01	G-CuSn10Zn	Rg10	-	-
2.6	600 - 650		2.0975	G-CuAl10Ni	CuNiAl11	-	-
N Kupfer-Aluminium-Legierungen (Alubronze) · Copper-aluminium alloys (alu bronze)							
2.7	> 550		AMPCO® 8	-	-	-	-
2.8	> 750		AMPCO® 21	-	-	-	-



	UNI	UNE	JIS	SIS	AISI/SAE/ASTM	
						K
-	-	-	-	-	-	3.1
-	-	-	-	-	-	3.2
-	-	-	-	-	-	3.2
-	-	-	-	-	-	3.2
-	-	-	-	-	-	3.2
						K
-		GTS 35	-	0810	32510	4.1
-		GTS 45	-	0852	40010	4.1
-		GTS 55	-	0854	50005	4.2
-		GTS 65	-	0856	70003	4.2
-		GTS 70	-	0862; 0864	90001	4.2
-		GTW 35	FCMW 330	-	MB 350-4	4.1
GMB 40		GTW 40	FCMW 370	-	MB 400-5	4.1
GMB 45		GTW 45	FCMWP 440	-	MB 450-7	4.1
-		GTW 55	-	-	-	4.2
						N
4507	L-3051	A1x1	-	-	-	1.1
-	-	-	-	-	-	1.1
						N
-	-	-	-	-	3105	1.1
3568	L-3810	144054	-	-	-	1.2
-	-	-	-	-	-	1.2
5764	L-3350	A2x8	144106	-	-	1.1
3575	L-3390	-	-	-	-	1.2
						N
3579	L-3120	-	-	-	-	1.3
3579	L-3140	A3x4	-	-	-	1.3
3571	L-3451	-	144212	-	-	1.3
3569	L-3441	A2x5	144103	-	-	1.2
-	-	-	-	-	-	1.2
811-04	-	-	-	-	7050	1.3
811-05	-	-	-	-	7175	1.3
						N
-	-	-	-	-	-	1.4
-	-	-	-	-	-	1.4
5080	-	-	-	-	-	1.4
3059	-	ADC6	-	-	-	1.4
						N
-	-	-	-	-	-	1.5
3051	-	AC4A	-	-	-	1.5
5075	-	-	-	-	-	1.5
3051	L-2560	-	4253	-	-	1.5
-	-	-	4253	-	A 360.2	1.5
3051	-	AC3	4261	-	A 413.2	1.5
3048	-	-	4260	-	A 413.1	1.5
						N
-	-	-	-	-	-	1.6
-	-	-	-	-	-	1.6
-	-	-	-	-	-	1.6
-	-	-	-	-	-	1.6
						N
-	-	C2300	-	-	C23000	2.2
-	-	C2600	-	-	C26000	2.2
						N
-	-	C 2700	-	-	C27200	2.2
P-CuZn35	-	C 2700	-	-	C27000	2.2
-	-	-	-	-	C28000	2.2
						N
-	-	-	-	-	C38500	2.3
						N
-	-	C 5111	-	-	C51100	2.5
-	-	C5210	-	-	C52100	2.5
						N
-	-	H 5111	-	-	C83600	2.6
-	-	-	-	-	C93200	2.6
-	-	-	-	-	-	2.6
-	-	-	-	-	-	2.6
						N
-	-	-	-	-	-	2.7
-	-	-	-	-	-	2.8



	R _m [N/mm ²]	Rockwell [HRC]					EN
			Mat.-Nr.	DIN	AFNOR	BS	
2.7	> 500		AMPCO® 25	-	-	-	-
2.8	> 810		AMPCO® 45	-	-	-	-
2.8	> 1000		AMPCO® M-4	-	-	-	-
N	Magnesium-Knetlegierungen · Magnesium wrought alloys						
3.1	> 270		3.5612	MgAl6Zn	-	-	-
3.2	> 240		3.5912	G-MgAl9Zn1	-	-	-
N	Kunststoffe · Synthetics						
4.1			Bakelit	-	-	-	-
4.1			Pertinax	-	-	-	-
4.2			PMMA	-	-	-	-
4.2			POM	-	-	-	-
4.2			PVC	-	-	-	-
N	Faserverstärkte Kunststoffe · Fibre-reinforced synthetics						
4.3	155 - 365		GFK	-	-	-	-
4.3	190 - 210		CFK uni.	-	-	-	-
4.3	190 - 210		CFK multi.	-	-	-	-
4.3			AFK	-	-	-	-
S	Nickel-, Kobalt- und Eisen-Legierungen · Nickel alloys, cobalt alloys and iron alloys						
2.6	900 - 1100		1.4718	X45CrSi9-3	Z 45 CS 9	401 S 45	52
2.6	500 - 750		1.4828	X15CrNiSi20-12	Z 15 CNS 20.12	309 S 24	-
2.6	550 - 800		1.4841	X15CrNiSi25-20	Z 15 CNS 25.20	-	-
2.6	500 - 750		1.4845	X12CrNi25-21	Z 12 CN 25.20	310 S 24	-
2.6	550 - 800		1.4864	X12NiCrSi36-16	Z 12 NCS 37.18	NA 17	-
2.6	950 - 1200		1.4871	X53CrMnNiN21-9	Z 52 CMN 21.09	349 S 54	-
2.6	500 - 750		1.4876	X10NiCrAlTi33-20	Z 8 NC 32.21	NA 15 (H)	-
2.6	500 - 750		1.4878	X12CrNiTi18-9	Z 6 CNT 18.12 (B)	321 S 20	-
2.2	500 - 700		2.4360	NiCu30Fe	Nu 30	NA 13	-
2.2	620 - 850		2.4375	NiCu30Al	Nu 30 AT	NA 18	-
2.2	> 690		2.4685	G-NiMo28	-	-	-
2.2	> 740		2.4610	NiMo16Cr16Ti	-	-	-
2.2	> 760		2.4617	G-NiMo30	-	-	-
2.2	700 - 800		2.4630, 2.4951	NiCr20Ti	NC 20 T	HR 5	-
2.2	800 - 1000		2.4631	NiCr20TiAl	-	HR 401; 601	-
2.3	1200		2.4632	NiCr20Co18Ti	-	-	-
2.3	1180		2.4634	NiCo20Cr15MoAlTi	-	-	-
2.2	< 770		2.4662	NiCr13Mo6Ti3	-	HR 53	-
2.3	900 - 1200		2.4670	-	-	-	-
2.3	900 - 1200		2.4674	-	-	-	-
2.3	1270		2.6554	-	-	-	-
2.2	890		2.4856	NiCr22Mo9Nb	NC 22 FeDNb	NA 21	-
2.3	< 1400		2.4668	NiCr19FeNbMo	NC 19Fe Nb	-	-
S	Reintitan, Titanlegierungen · Pure titanium, titanium alloys						
1.1	290 - 410		3.7025	Ti99.5 / Ti Gr.1	-	-	-
1.1	380 - 540		3.7035	Ti99.4 / Ti Gr.2	-	TA 1	-
1.2	460 - 590		3.7055	Ti99.3 / Ti Gr.3	-	TA 2	-
1.2	540 - 740		3.7065	Ti99.2 / Ti Gr.4	-	TA 3	-
1.1	390 - 540		3.7235	Ti2Pd / Ti Gr.2Pd	-	-	-
1.2	> 890		3.7165	TiAl6V4 / Ti Gr. 5	T-A6V	TA 28	-
1.3	> 1000		3.7185	TiAl4Mo4Sn2	-	-	-
H	Gehärtete Stähle, Hartguss · Hardened steels, hard castings						
1.1	1250 - 1550	< 50	Weldox 1100	-	-	-	-
1.2	1600 - 1800	< 55	Hardox 500	-	-	-	-
1.2	1820 - 1900	< 55	Hardox 550	-	-	-	-
1.2	~ 1860	< 55	1.2713	55NiCrMoV6	55 NCDV 7	-	-
1.3	1995 - 2300	< 60	Armox 600T	-	-	-	-
1.3	~ 2100	< 60	1.2542	45WCv7	-	BS 1	-
1.4		< 63	Ferro-Titanit	-	-	-	-
1.4		< 63	1.2379	X155CrVMo12-1	Z 160 CDV 12	BD 2	-
1.5		< 66	HSSE	-	-	-	-
1.5		< 66	1.2436	X210CrW12	-	-	-



	UNI	UNE	JIS	SIS	AISI/SAE/ASTM	
-	-	-	-	-	-	2.7
-	-	-	-	-	-	2.8
-	-	-	-	-	-	2.8
N						
-	-	-	-	-	-	3.1
-	-	-	-	-	-	3.2
N						
-	-	-	-	-	-	4.1
-	-	-	-	-	-	4.1
-	-	-	-	-	-	4.2
-	-	-	-	-	-	4.2
-	-	-	-	-	-	4.2
N						
-	-	-	-	-	-	4.3
-	-	-	-	-	-	4.3
-	-	-	-	-	-	4.3
-	-	-	-	-	-	4.3
S						
X 45 CrSi 8	-	-	SUH 1	-	HNV 3	2.6
-	-	-	SUH 309	-	309	2.6
X 16 CrNiSi 25 20	-	-	SUH 310	-	314; 310	2.6
X 6 CrNi 26 20	F.331	-	SUH 310; SUS 310 S	-	310 S	2.6
-	-	-	SUH 330	-	330	2.6
X 53 CrMnNiN 21 9	-	-	SUH 35; SUH 36	-	EV 8	2.6
-	-	-	NCF 800	-	B 163	2.6
X 6 CrNiTi 18 11	-	-	SUS 321	2337	321	2.6
-	-	-	-	-	Monel 400	2.2
-	-	-	-	-	Monel K-500	2.2
-	-	-	-	-	Hastelloy B	2.2
-	-	-	-	-	Hastelloy C-4	2.2
-	-	-	-	-	Hastelloy B-2	2.2
-	-	-	-	-	Nimonic 75	2.2
-	-	-	NCF 80 A	-	Nimonic 80 A	2.2
-	-	-	-	-	Nimonic 90	2.3
-	-	-	-	-	Nimonic 105	2.3
-	-	-	-	-	Nimonic 901	2.2
-	-	-	-	-	Nimocast 713	2.3
-	-	-	-	-	Nimocast PK 24	2.3
-	-	-	-	-	Waspaloy	2.3
-	-	-	-	-	Inconel 625	2.2
-	-	-	-	-	Inconel 718	2.3
S						
-	-	-	-	-	-	1.1
-	-	-	-	-	-	1.1
-	-	-	-	-	-	1.2
-	-	-	-	-	-	1.2
-	-	-	-	-	-	1.1
-	-	-	-	-	R56400	1.2
-	-	-	-	-	-	1.3
H						
-	-	-	-	-	Weldox 1100	1.1
-	-	-	-	-	Hardox 500	1.2
-	-	-	-	-	Hardox 550	1.2
-	F.520.S	-	SKT 4	-	L 6	1.2
-	-	-	-	-	Armox 600T	1.3
45 WCrV 8 KU	45WCrSi8	-	-	2710	S 1	1.3
-	-	-	-	-	Ferro-Titanit	1.4
X 155 CrVMo 12 1KU	-	-	SKD 11	-	D 2	1.4
-	-	-	-	-	HSSE	1.5
X 215 CrW 12 1 KU	X210CrW12	-	SKD 2	2312	-	1.5



Der Service ist so wichtig wie das Produkt selbst. Aus diesem Grund hat EMUGE-FRANKEN ein umfangreiches Kommunikations- und Servicesystem geschaffen. Nachfolgend finden Sie einige Beispiele dafür.

Service is just as important as the product itself. For this reason, EMUGE-FRANKEN has created a comprehensive communication and service system. Please see the following examples:

Weltweite Präsenz

Ihren zuständigen Ansprechpartner können Sie über unsere Zentralen in Lauf und Rückersdorf oder im Internet unter www.emuge-franken.com abfragen.

Worldwide presence

Please see our homepage – www.emuge-franken.com –, or contact our service staff in Lauf or Rückersdorf, to find out who is responsible for your area.

Systemlösungen

Eine sehr enge Zusammenarbeit mit den Werkzeugmaschinenherstellern ermöglicht uns einen umfangreichen Überblick über die Prozessparameter. Wenn Sie nach prozesssicheren Fertigungslösungen suchen, ist unser Experten-Team gerne bereit, mit Ihnen gemeinsam die wirtschaftlichste Problemlösung zu erarbeiten.

System solutions

Our close cooperation with machine tool makers means that we have a profound understanding of all aspects of machining. If you are looking for manufacturing solutions with reliable processes, our team of experts will be happy to assist you in finding the most economical solution for your application.

Messen/Informationsveranstaltungen

Über Messebeteiligungen weltweit werden Interessenten ständig über technologische Entwicklungen und Neuprodukte von EMUGE-FRANKEN informiert.

Fairs and exhibitions/Information events

We take part in a variety of international exhibitions to provide you with information about technological developments and new products from EMUGE-FRANKEN.

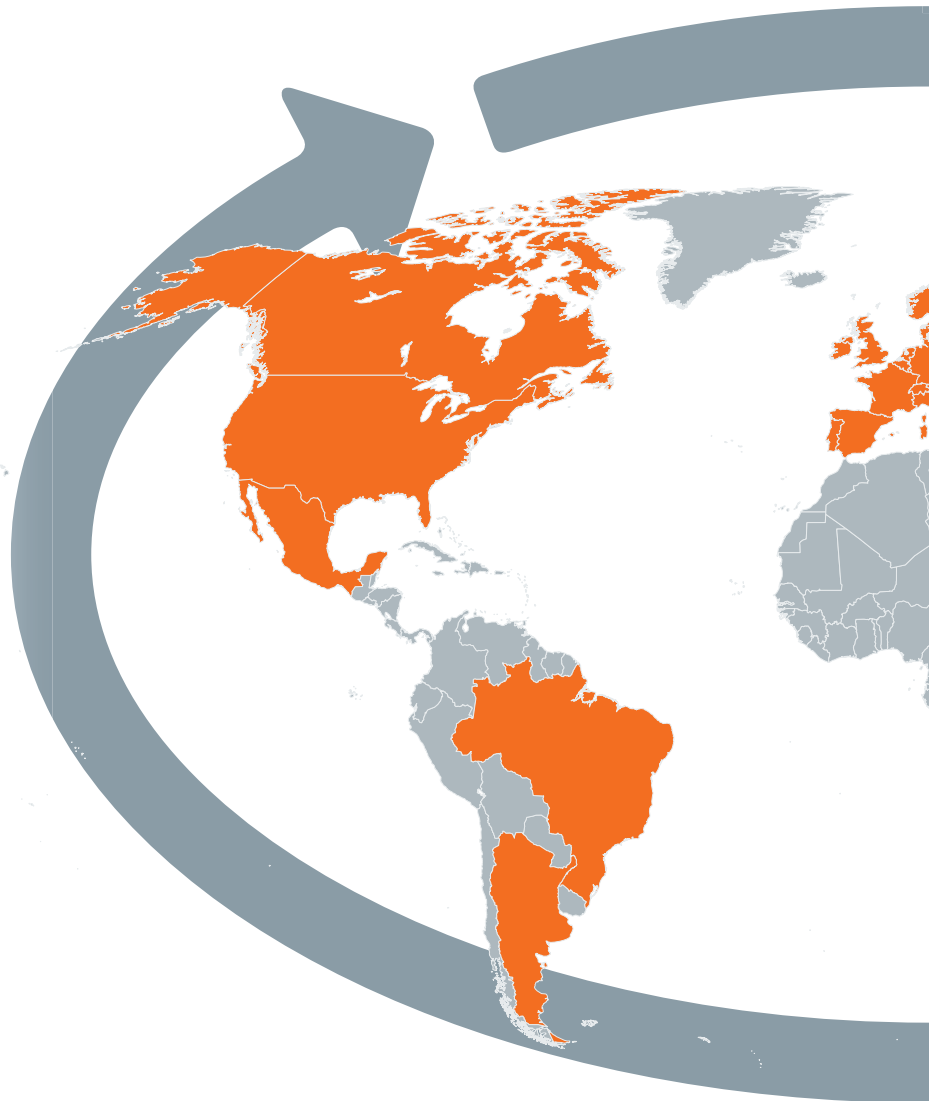

Nachschleif- und Nachbeschichtungsservice

Auch das leistungsfähigste Zerspanungswerkzeug wird einmal stumpf. Wir bieten Ihnen einen Nachschleif- und Nachbeschichtungsservice in Herstellerqualität. Gerne beraten wir Sie vor Ort oder in unserem Haus.

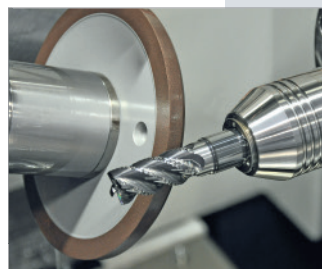

Regrinding and recoating service

Even the most efficient tool will become blunt eventually. We can offer you a regrinding and recoating service in manufacturer quality. We will be happy to advise you either here at the company or at your premises.



Print-Medien

Neben unseren umfangreichen Katalogen bieten wir Sonderprospekte, Fachartikel, Wandtafeln und vieles mehr.

Sales literature

In addition to our comprehensive catalogues, we offer special brochures, reprints of technical articles, wall charts, and much more.

Technisches Handbuch

Das Handbuch der Gewindetechnik und Frästechnik ist das Nachschlagewerk für die Fertigungsoptimierung. Ein Standardwerk für jeden metall- und kunststoffverarbeitenden Betrieb, mit relevanten DIN-Normen. (752 Seiten, DIN A4, nur deutschsprachig) ISBN 3-89578-232-7

Manual of Threading and Milling Technology

The new Manual of Threading and Milling Technology is the reference book for production optimisation. A standard work of reference for any company that machines metals or synthetics, with the most relevant DIN standards. (752 pages, DIN A4, available only in German) ISBN 3-89578-232-7

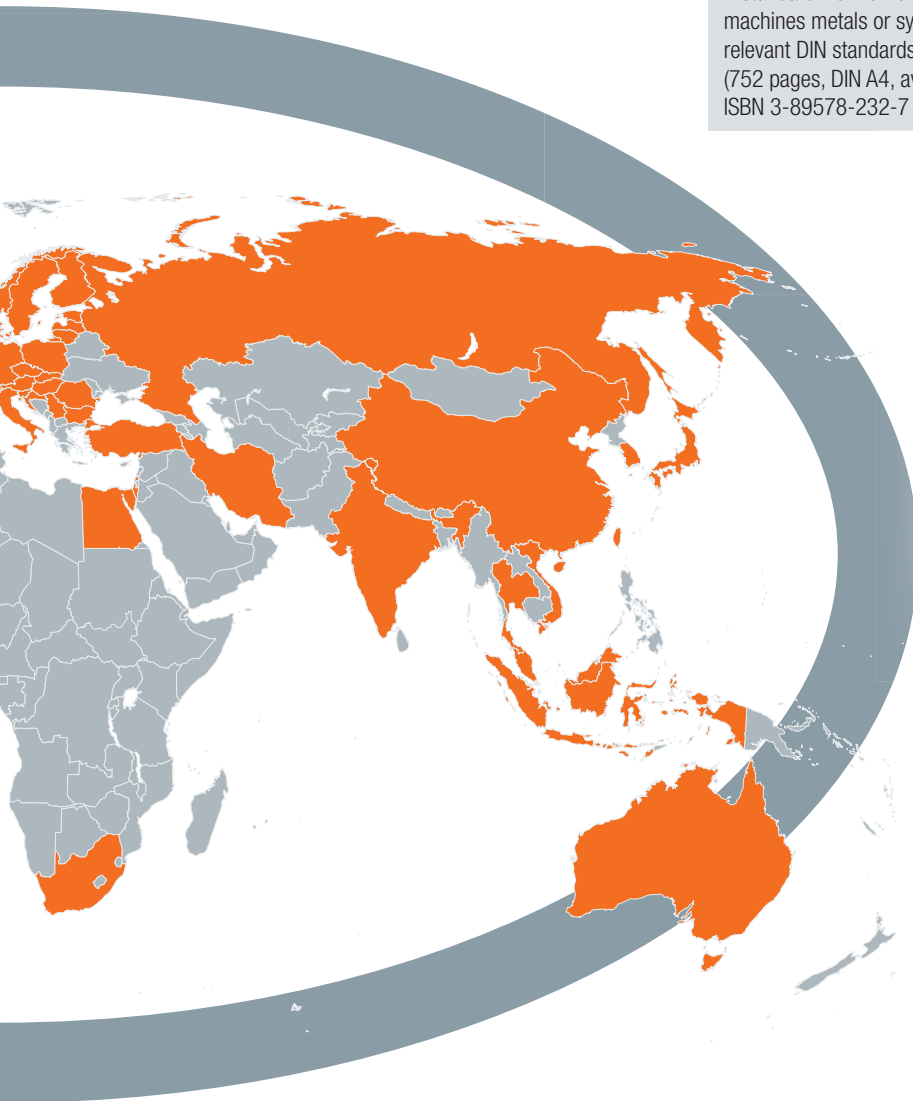

Lieferservice

EMUGE-FRANKEN verfügt über eines der größten Werkzeuglager in der Branche. Somit wird sichergestellt, dass auch bei Spezialwerkzeugen kürzeste Lieferzeiten eingehalten werden können.

Delivery service

EMUGE-FRANKEN has a more extensive stock-holding than almost any other company in the industry. This helps us to make sure that even very special tools can be supplied within the shortest possible delivery times.



EMUGE-FRANKEN Internet-Service EFIS

Auskünfte über Verfügbarkeit und Preise der lagerhaltigen Werkzeuge von EMUGE-FRANKEN erhalten Sie innerhalb weniger Minuten, unabhängig von der Verfügbarkeit eines Ansprechpartners.

EMUGE-FRANKEN Internet Service EFIS

Information about price and availability of stock tools is always available at a glance, even if your contact person is not available.

Anwendungstechnik

Die Abteilung „Anwendungstechnik“ ist die Service- und Dienstleistungsabteilung für den weltweit bestehenden Kundenkreis. Für die von EMUGE-FRANKEN angebotenen Produkte steht dieses Expertenteam weltweit zur Verfügung.

Technical service

The Technical Service Department is the service and consulting partner for our customers worldwide. This team of experts will help you with any question regarding EMUGE-FRANKEN products.

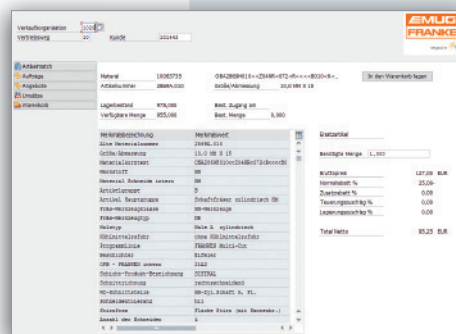

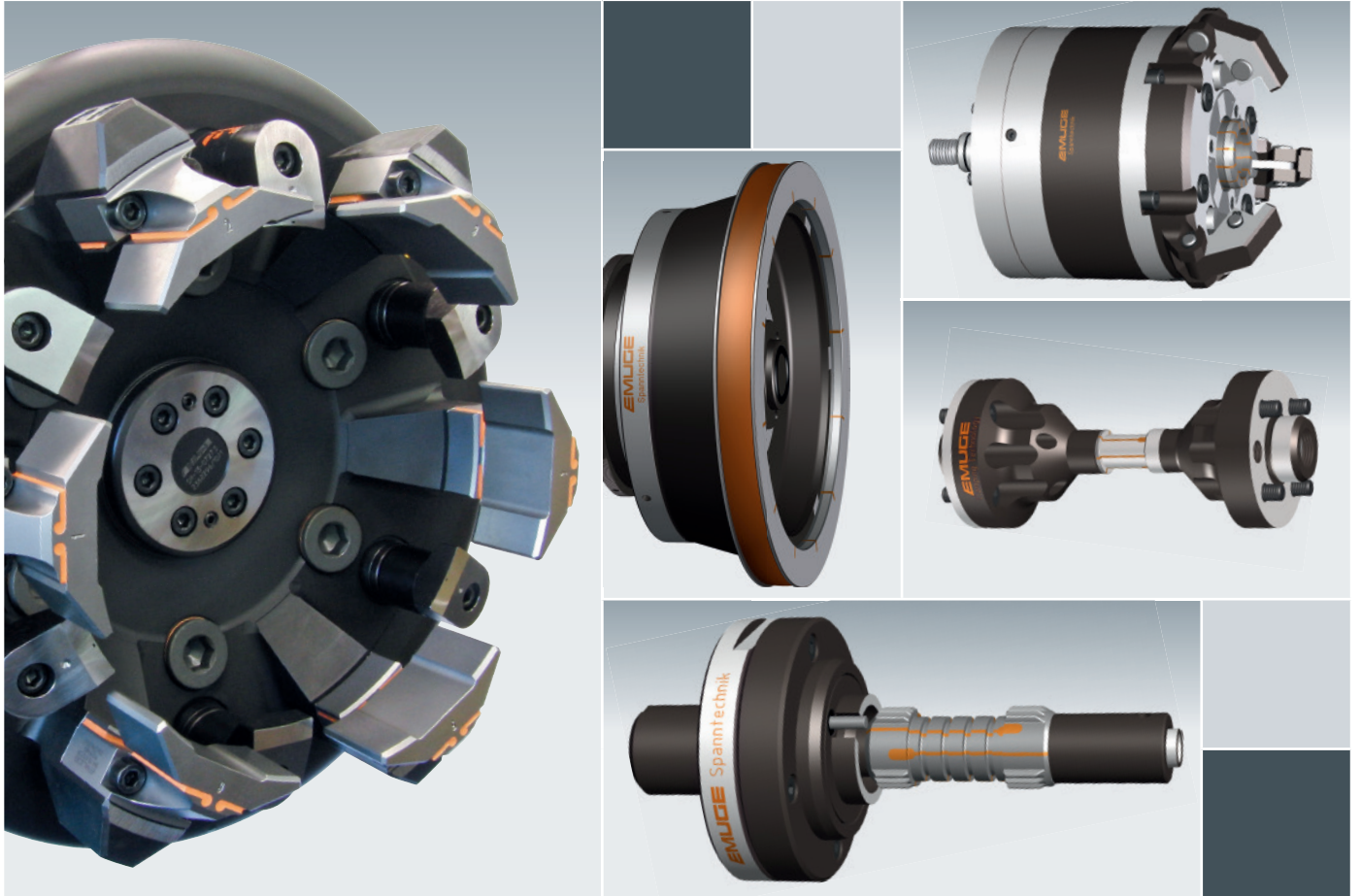

Werkstückspannung Workpiece Clamping



Neben Spannzangen-Aufnahmen, Schnellwechsel-Aufnahmen und Gewindeschneidapparaten bietet EMUGE auch **Präzisionsspannmittel für die Werkstückspannung**. Die überwiegende Anzahl dieser Spannzeuge wird speziell für die von den Kunden geschilderten Anwendungsfälle konstruiert und sind somit **auf den Fertigungsprozess optimierte Sonderlösungen**. Dabei werden schon in der Planungsphase sämtliche Rahmenbedingungen wie z.B. Maschinenausstattung, Genauigkeitsanforderungen und Prozessablauf so praxisnah wie möglich berücksichtigt.

In addition to our collet holders, quick-change holders and tapping attachments, EMUGE also offers **precision clamping tools for workpiece clamping**. The largest part of these clamping tools are designed especially for individual customers' applications, and are, as a consequence, **highly optimised special solutions for specific production processes**. In order to achieve such solutions, it is strictly necessary to analyse all the basic conditions, e.g. machine equipment, precision requirements, details of the production process etc., even in the first planning stage, with a close view to practical work conditions.

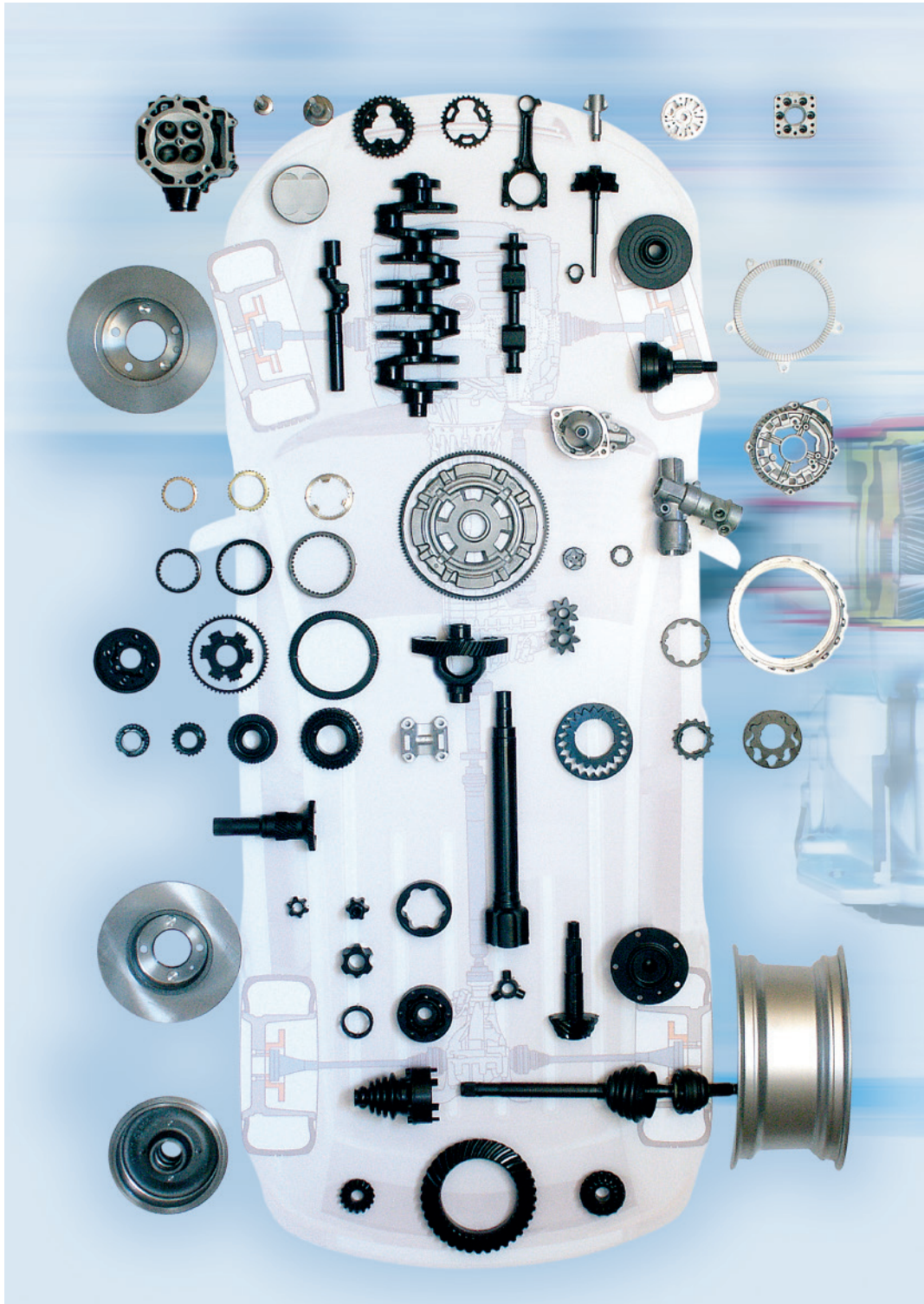

Systemspezifikationen

Die Werkstückspannung ist ein wesentliches Element im Produktionsprozess. Die überwiegende Anzahl dieser Spannzeuge wird speziell für die von den Anwendern geschilderten Einsatzfälle konstruiert und sind somit auf den Fertigungsprozess optimierte Sonderlösungen.

Bei der Entwicklung dieser Spannmittel sind sämtliche Voraussetzungen wie Maschinenausrüstung, Genauigkeitsanforderungen und Prozessablauf so praxisnah wie möglich zu berücksichtigen. EMUGE, einer der führenden Hersteller solcher Spannmittel, bedient sich verschiedener Spannprinzipien, die nachfolgend beschrieben werden. Die unten aufgeführten Werte sind lediglich **Richtwerte**.

System specifications

Workpiece clamping is an essential element of the production process. The largest part of these clamping tools are specially designed for the application case described by the user, which means they are special solutions optimised for the individual production process.

In the development of these clamping tools, all basic conditions like machine equipment, precision requirements and process sequence, must be taken into account with as much regard to practical conditions as possible. EMUGE, as one of the leading manufacturers of such clamping equipment, uses various clamping principles which we will describe in detail below. The values listed below are only **reference values**.

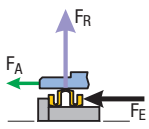
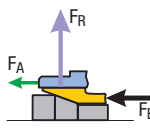
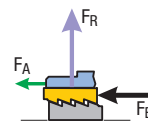
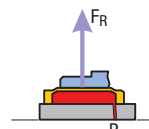
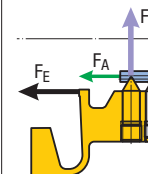
Eigenschaften Features	System				
	SP	SZ	SG	SH	SM
Systemaufbau System set-up					
Erreichbare Rundlaufgenauigkeit Achievable concentricity	2 µm	4 µm	4 µm	2 µm	4 µm
Max. Expansion in Bezug zum Spanndurchmesser Max. expansion in reference to clamping diameter	IT7 (11)	IT13	IT13	IT7	0,1 - 0,6 mm
Spannbereiche Werkstück-Außendurchmesser Clamping ranges, workpiece outside diameter	5 - 400 mm	5 - 400 mm	6 - 300 mm	5 - 300 mm	6 - 300 mm
Spannbereiche Werkstück-Innendurchmesser Clamping ranges, workpiece inside diameter	12 - 400 mm	8 - 400 mm	12 - 300 mm	12 - 300 mm	—
Sicherheitsfunktion gegen Überspannen Safety function against over-clamping	ja yes	ja yes	ja yes	bedingt partially	ja yes
Verschleißschutzbeschichtung möglich Wear protection coating possible	ja yes	ja yes	ja yes	ja yes	ja yes

F_R = Radialkraft
Radial force

F_A = Axialkraft
Axial force

F_E = Kräfteinleitung
Application of force

P_E = Druckeinleitung
Application of pressure

Toleranzranggrad Degree of tolerance	Nennmaßbereich in mm Nominal size range in mm											
	≤ 3	> 3 ≤ 6	> 6 ≤ 10	> 10 ≤ 18	> 18 ≤ 30	> 30 ≤ 50	> 50 ≤ 80	> 80 ≤ 120	> 120 ≤ 180	> 180 ≤ 250	> 250 ≤ 315	> 315 ≤ 400
IT7	10	12	15	18	21	25	30	35	40	46	52	57
IT11	60	75	90	110	130	160	190	220	250	290	320	360
IT13	140	180	220	270	330	390	460	540	630	720	810	890



System SP

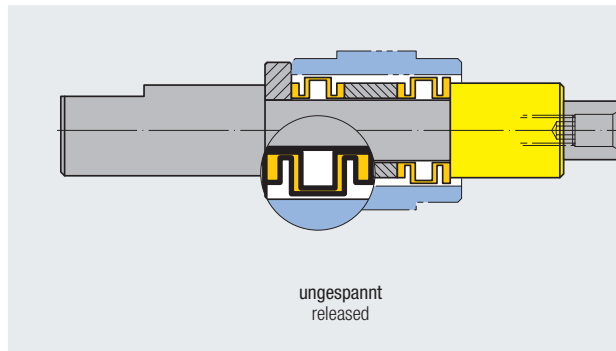

Durch eine axiale Kraftbeaufschlagung bewegen sich die Spannhülsen in Krafrichtung und dehnen sich dabei radial aus. Hierdurch wird einerseits das Spiel zwischen Spannhülse und Grundkörper, andererseits zwischen Spannhülse und Werkstück beseitigt. Das Werkstück wird gespannt.

In Abhängigkeit von der Toleranz des Werkstücks und der Ausführung des Spannzeugs und der Spannhülsen können mit dem System SP Rundlaufabweichungen $\leq 0,002$ mm erreicht werden.

Durch diese hohe Genauigkeit wird das System SP nicht nur bei der Werkstück-, sondern auch bei der Werkzeugspannung eingesetzt.

System SP

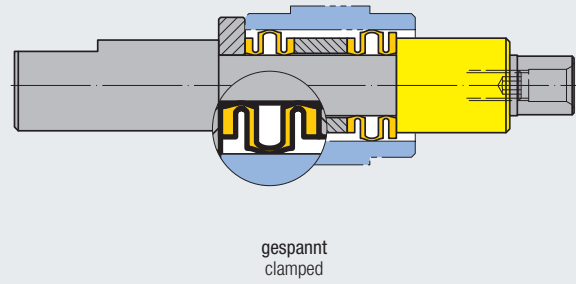

By applying an axial force the clamping sleeves move in direction of the force and expand radially. On the one hand this eliminates the clearance between clamping sleeve and body, on the other hand between clamping sleeve and workpiece. The workpiece is being clamped.

Depending on the tolerance of the workpiece, on the design of the clamping tool and of the clamping sleeves the system SP achieves concentricities of ≤ 0.002 mm (corresponding to ≤ 0.0001 inch).

Due to this high precision the system SP is not only used to clamp workpieces, it is also used to clamp tools.

System SZ

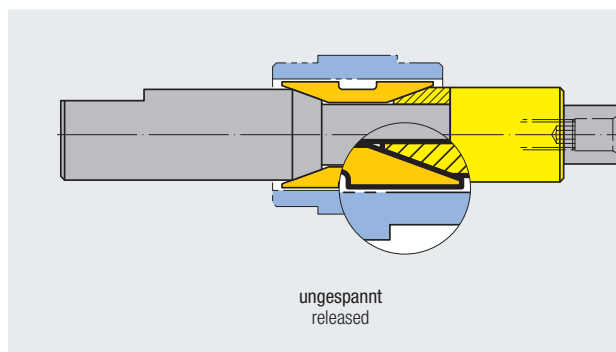

Wenn das zu spannende Werkstück nur eine kurze Spannbasis oder der zu spannende Durchmesser eine sehr große Toleranz hat, so kommt das System SZ zum Einsatz.

Hierbei wird eine geschlitzte Spannzanze durch das Einleiten einer Axialkraft über einen Kegel radial aufgeweitet. Gleichzeitig findet auch eine axiale Bewegung statt. Das Werkstück wird gespannt.

System SZ

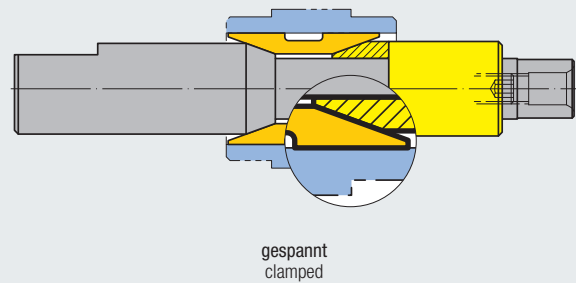

If the workpiece to be clamped has only a short clamping base or if the diameter to be clamped has a very large tolerance, system SZ is used.

By applying an axial force a slitted collet is radially expanded by a cone. Simultaneously an axial movement occurs. The workpiece is being clamped.



System SG

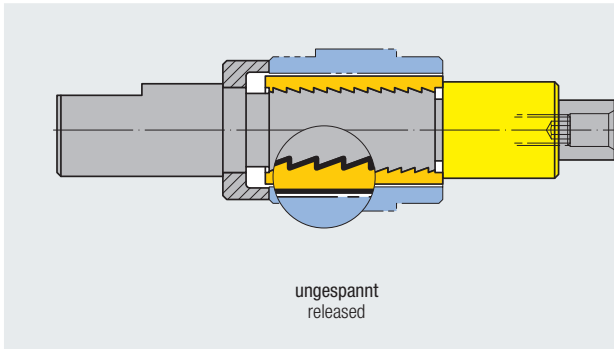

Bedingt durch die Bauart erlaubt das System SP nur Aufweitungen bis etwa zur Toleranzklasse IT11. Sollen größere Toleranzen überbrückt werden, so kommt das System SG zum Einsatz.

Dabei wird eine geschlitzte Spannbüchse mit einem speziellen Sägewinde auf den Grundkörper geschraubt. Bei einer axialen Kraftbeaufschlagung bewegt sich die Spannbüchse in Krafrichtung und dehnt sich gleichzeitig auf Grund des Flankenwinkels in radialer Richtung. Das Werkstück wird gespannt.

Die auf das Werkstück wirkende axiale Komponente erhöht das übertragbare Drehmoment und die Steifigkeit der Spannung. Somit werden auch Werkstücke, die mit einem großen Spannerschnitt bearbeitet werden, sicher gespannt.

System SG

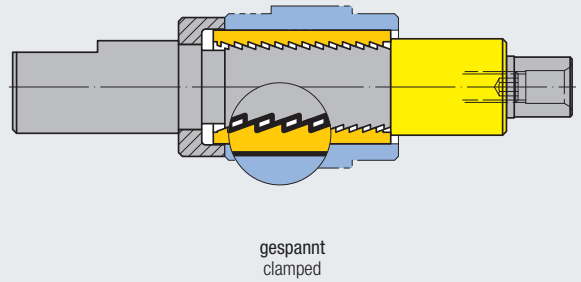

Depending on the type of design the system SP only allows radial expansion up to tolerance class IT11. To bridge larger tolerances, system SG is used.

This is a slitted clamping bush with a special buttress thread. With this thread the bush is screwed onto the body. By applying an axial force the clamping bush moves in direction of the force. Due to the thread angle there is also a radial expansion. The workpiece is being clamped.

The axial component, which has an effect on the workpiece, increases the transferable torque and the stiffness of the clamping process. Consequently the workpiece is safely clamped even if it is machined with a large depth of cut.

System SH

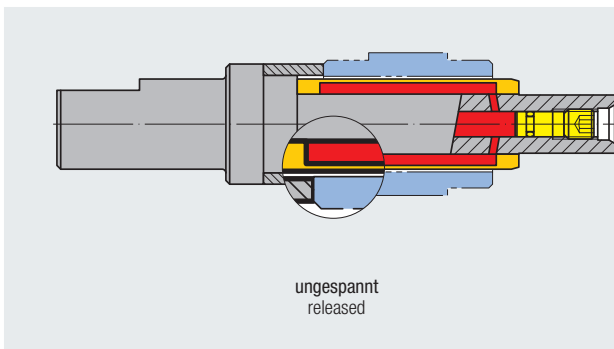

Hydraulische Spannsysteme SH werden bei stark begrenztem Bauraum eingesetzt. Es lassen sich damit auch lange, dünnwandige Werkstücke oder mehrere gleiche Werkstücke spannen.

Dabei handelt es sich um geschlossene Systeme, die mit Hydrauliköl gefüllt sind. Dieses wird mit einem Kolben beaufschlagt. Der sich aufbauende Druck weitet die dünnwandige Dehnzone radial auf und spannt somit das bzw. die Werkstücke.

System SH

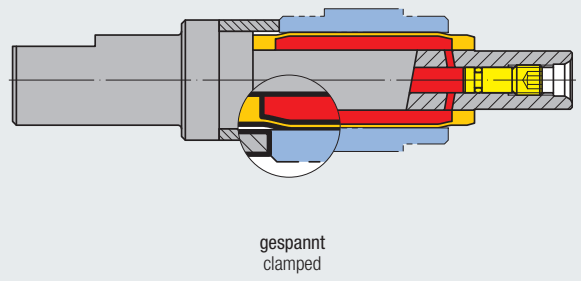

If there is not enough room for a mechanical clamping system, hydraulic system SH is used. It also allows clamping long, thin-walled workpieces or a number of similar workpieces.

System SH is a closed system filled with hydraulic oil. A force is applied on it with a piston. The hydraulic pressure radially expands the thin-walled clamping zone. The workpiece/the workpieces is/are being clamped.



System SM

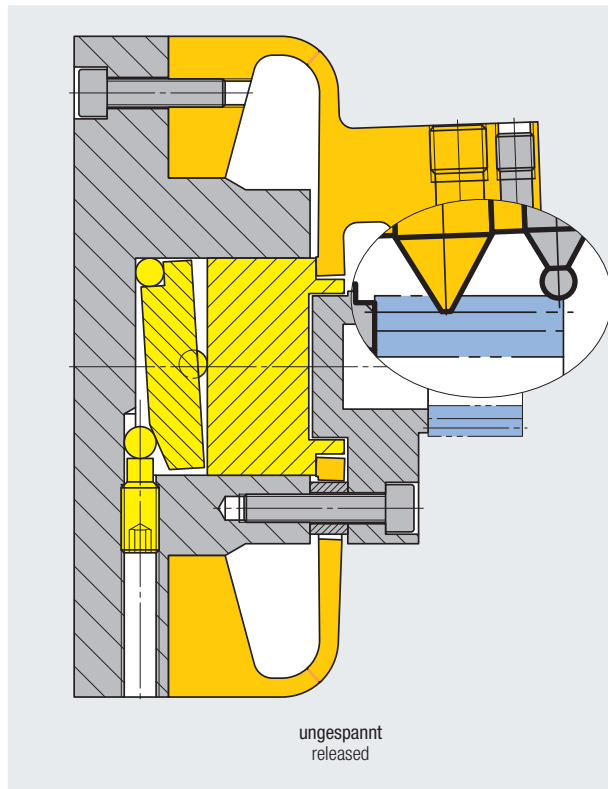

System SM

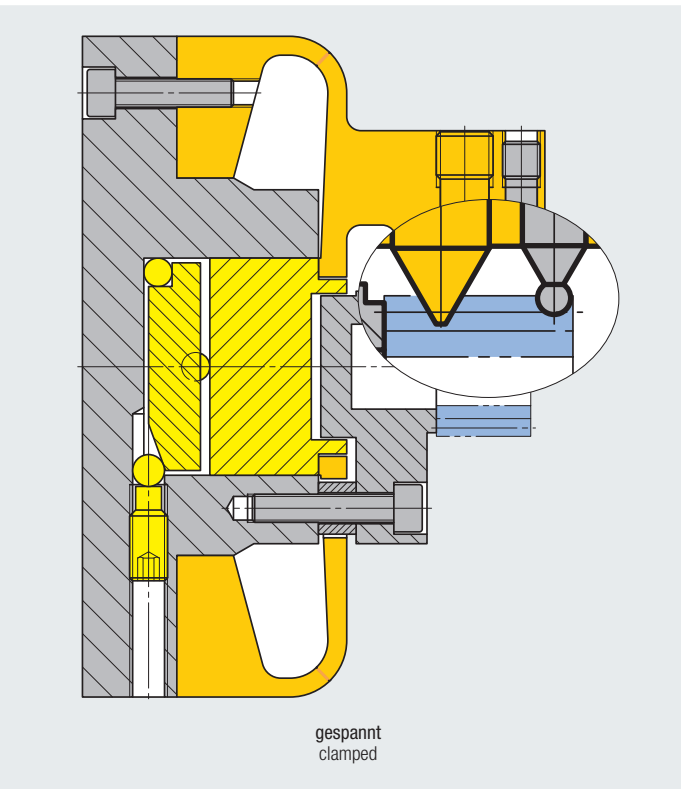

Bei der Fertigung von z. B. hochgenauen Zahnrädern ist es sehr wichtig, die Rundlaufabweichung zwischen dem Teilkreis und der Aufnahmebohrung möglichst gering zu halten.

Hierzu dient das Membranspannsystem SM. Es ermöglicht, das Zahnrad im Teilkreis zu spannen und die Aufnahmebohrung zu bearbeiten.

Das Spannelement ist eine Ringscheibe mit vorzugsweise drei Spannbacken. Bei einem dünnwandigen Werkstück kann die Membran auch vier oder sechs Spannbacken haben. Diese sind entweder aus der Membran herausgearbeitet oder aufgeschraubt.

Wird in axialer Richtung Kraft auf die Membran ausgeübt, so biegt sich diese durch. Dabei bewegen sich die Membranspannbacken axial und öffnen gleichzeitig radial. Das Zahnrad wird freigegeben.

Wegen ihres Eigenfederverhaltens kehrt die Membran in ihre Ausgangslage zurück, sobald die Axialkraft verringert oder weggenommen wird. Das Zahnrad wird in radialer und axialer Richtung gespannt.

In order to manufacture high precision gear wheels for example, it is very important that the eccentricity between pitch circle and seating bore is very small.

For this purpose the diaphragm clamping system SM is used. For machining the seating bore it allows clamping of the gear wheel at the pitch circle.

The clamping element is a ring disk with primarily three clamping jaws. If the workpiece is thin-walled the diaphragm can also have four or six clamping jaws. These are either carved out of the diaphragm or they are screwed onto it.

By applying an axial force onto the diaphragm, it bends in direction of the force. The clamping jaws simultaneously move axially and open in radial direction. The gear wheel is being released.

Due to its flexibility the diaphragm returns to its initial position if the axial force is reduced or taken away. The gear wheel is being clamped in axial and radial direction.



Hinweis:

Die allgemeinen Geschäftsbedingungen können Sie bei der für Sie zuständigen Landesvertretung anfordern.

Please note:

If you want specific General Sales Conditions for your own country, please ask your local contact.

I. Allgemeines

1. Allen Lieferungen und Leistungen liegen diese Bedingungen sowie etwaige gesonderte vertragliche Vereinbarungen zugrunde. Abweichende Einkaufsbedingungen des Bestellers werden auch durch Auftragsannahme nicht Vertragsinhalt.
Ein Vertrag kommt – mangels besonderer Vereinbarung – mit der schriftlichen Auftragsbestätigung des Lieferers zustande.
2. Der Lieferer behält sich an Mustern, Kostenvoranschlägen, Zeichnungen u.ä. Informationen körperlicher und unkörperlicher Art – auch in elektronischer Form – Eigentums- und Urheberrechte vor; sie dürfen Dritten nicht zugänglich gemacht werden. Der Lieferer verpflichtet sich, vom Besteller als vertraulich bezeichnete Informationen und Unterlagen nur mit dessen Zustimmung Dritten zugänglich zu machen.
3. Muster werden nur gegen Berechnung geliefert.
4. Mündliche Nebenabreden bestehen nicht. Änderungen bedürfen der Schriftform.

II. Preis und Zahlung

1. Die Preise gelten mangels besonderer Vereinbarung ab Werk einschließlich Verladung im Werk, jedoch ausschließlich Verpackung und Entladung. Zu den Preisen kommt die Umsatzsteuer in der jeweiligen gesetzlichen Höhe hinzu.
2. Mangels besonderer Vereinbarung ist die Zahlung ohne jeden Abzug á Konto des Lieferers zu leisten. Berechnet wird die jeweilige Liefermenge.
3. Das Recht, Zahlungen zurückzuhalten, steht dem Besteller nur insoweit zu, als seine Gegenansprüche unbestritten oder rechtskräftig festgestellt sind.
4. Das Recht des Bestellers, mit Gegenansprüchen aus anderen Rechtsverhältnissen aufzurechnen, steht ihm nur insoweit zu, als sie unbestritten oder rechtskräftig festgestellt sind.

III. Lieferzeit, Lieferverzögerung

1. Die Lieferzeit ergibt sich aus den Vereinbarungen der Vertragsparteien. Ihre Einhaltung durch den Lieferer setzt voraus, dass alle kaufmännischen und technischen Fragen zwischen den Vertragsparteien geklärt sind und der Besteller alle ihm obliegenden Verpflichtungen, wie z.B. Beibringung der erforderlichen behördlichen Bescheinigungen oder Genehmigungen oder die Leistung einer Anzahlung erfüllt hat. Ist dies nicht der Fall, so verlängert sich die Lieferzeit angemessen. Dies gilt nicht, soweit der Lieferer die Verzögerung zu vertreten hat.

2. Die Einhaltung der Lieferzeit steht unter dem Vorbehalt richtiger und rechtzeitiger Selbstbelieferung. Sich abzeichnende Verzögerungen teilt der Lieferer sobald als möglich mit.
3. Die Lieferzeit ist eingehalten, wenn der Liefergegenstand bis zu ihrem Ablauf das Werk des Lieferers verlassen hat oder die Versandbereitschaft gemeldet ist. Soweit eine Abnahme zu erfolgen hat, ist – außer bei berechtigter Abnahmeverweigerung – der Abnahmetermin maßgebend, hilfsweise die Meldung der Abnahmebereitschaft.
4. Werden der Versand bzw. die Abnahme des Liefergegenstandes aus Gründen verzögert, die der Besteller zu vertreten hat, so werden ihm, beginnend einen Monat nach Meldung der Versand- bzw. der Abnahmebereitschaft, die durch die Verzögerung entstandenen Kosten berechnet.
Wird der Versand auf Wunsch des Bestellers verzögert, so ist der Lieferer berechtigt, nach Setzung und fruchtlosem Ablauf einer angemessenen Frist, anderweitig über den Liefergegenstand zu verfügen und den Besteller mit angemessen verlängerter Frist zu beliefern.
5. Ist die Nichteinhaltung der Lieferzeit auf höhere Gewalt, auf Arbeitskämpfe oder sonstige Ereignisse, die außerhalb des Einflussbereiches des Lieferers liegen, zurückzuführen, so verlängert sich die Lieferzeit angemessen. Der Lieferer wird dem Besteller den Beginn und das Ende derartiger Umstände baldmöglichst mitteilen.
6. Der Besteller kann ohne Fristsetzung vom Vertrag zurücktreten, wenn dem Lieferer die gesamte Leistung vor Gefahrübergang endgültig unmöglich wird. Der Besteller kann darüber hinaus vom Vertrag zurücktreten, wenn bei einer Bestellung die Ausführung eines Teils der Lieferung unmöglich wird und er ein berechtigtes Interesse an der Ablehnung der Teillieferung hat. Ist dies nicht der Fall, so hat der Besteller den auf die Teillieferung entfallenen Vertragspreis zu zahlen. Dasselbe gilt bei Unvermögen des Lieferers. Im Übrigen gilt Abschnitt VIII.2.
Tritt die Unmöglichkeit oder das Unvermögen während des Annahmeverzuges ein oder ist der Besteller für diese Umstände allein oder weit überwiegend verantwortlich, bleibt er zur Gegenleistung verpflichtet.
7. Kommt der Lieferer in Verzug und erwächst dem Besteller hieraus ein Schaden, so ist er berechtigt, eine pauschale Verzugsentschädigung zu verlangen. Sie beträgt für jede volle Woche der Verspätung 0,5 %, im Ganzen aber höchstens 5 % vom Wert desjenigen Teils der Gesamtlieferung, der infolge der Verspätung nicht rechtzeitig oder nicht vertragsgemäß genutzt werden kann.

Setzt der Besteller dem Lieferer – unter Berücksichtigung der gesetzlichen Ausnahmefälle – nach Fälligkeit eine angemessene Frist zur Leistung und wird die Frist nicht eingehalten, ist der Besteller im Rahmen der gesetzlichen Vorschriften zum Rücktritt berechtigt. Er verpflichtet sich, auf Verlangen des Lieferers in angemessener Frist zu erklären, ob er von seinem Rücktrittsrecht Gebrauch macht.

Weitere Ansprüche aus Lieferverzug bestimmen sich ausschließlich nach Abschnitt VII. 2 dieser Bedingungen.

IV. Gefahrübergang, Abnahme

1. Die Gefahr geht auf den Besteller über, wenn der Liefergegenstand das Werk verlassen hat, und zwar auch dann, wenn Teillieferungen erfolgen oder der Lieferer noch andere Leistungen, z.B. die Versandkosten oder Anlieferung und Aufstellung, übernommen hat. Soweit eine Abnahme zu erfolgen hat, ist diese für den Gefahrübergang maßgebend. Sie muss unverzüglich zum Abnahmetermin, hilfsweise nach der Meldung des Lieferers über die Abnahmebereitschaft durchgeführt werden. Der Besteller darf die Abnahme bei Vorliegen eines nicht wesentlichen Mangels nicht verweigern.
2. Verzögert sich oder unterbleibt der Versand bzw. die Abnahme infolge von Umständen, die dem Lieferer nicht zuzurechnen sind, geht die Gefahr vom Tage der Meldung der Versand- bzw. Abnahmebereitschaft auf den Besteller über. Der Lieferer verpflichtet sich, auf Kosten des Bestellers die Versicherungen abzuschließen, die dieser verlangt.
3. Teillieferungen sind zulässig, soweit für den Besteller zumutbar.

V. Eigentumsvorbehalt

1. Der Lieferer behält sich das Eigentum an dem Liefergegenstand vor, bis sämtliche Forderungen des Lieferers gegen den Besteller aus der Geschäftsverbindung einschließlich der künftig entstehenden Forderungen, auch aus gleichzeitig oder später abgeschlossenen Verträgen, beglichen sind. Dies gilt auch dann, wenn einzelne oder sämtliche Forderungen des Lieferers in eine laufende Rechnung aufgenommen wurden und der Saldo gezogen und anerkannt ist.
Bei vertragswidrigem Verhalten des Bestellers, insbesondere bei Zahlungsverzug, ist der Lieferer zur Rücknahme des Liefergegenstandes nach Mahnung berechtigt und der Besteller zur Herausgabe verpflichtet. Auf Grund des Eigentumsvorbehalts kann der Lieferer den Liefergegenstand nur herausverlangen, wenn er vom Vertrag zurückgetreten ist. Bei Pfändungen oder sonstigen Eingriffen



Dritter hat der Besteller den Lieferer unverzüglich zu benachrichtigen.

2. Der Besteller ist berechtigt, den Liefergegenstand im ordentlichen Geschäftsgang weiterzuveräußern. Er tritt jedoch dem Lieferer bereits jetzt alle Forderungen ab, die ihm aus der Weiterveräußerung gegen den Abnehmer oder gegen Dritte erwachsen.
Zur Einziehung dieser Forderungen ist der Besteller auch nach der Abtretung ermächtigt. Die Befugnis des Lieferers, die Forderungen selbst einzuziehen, bleibt hiervon unberührt. Die Einziehungsbefugnis erlischt, wenn
 - der Besteller mit seinen Zahlungsverpflichtungen gegenüber dem Lieferer in Verzug gerät oder
 - sie widerrufen ist oder
 - ein Antrag auf Eröffnung eines Insolvenzverfahrens gestellt ist.
 Der Lieferer kann dann verlangen, dass der Besteller ihm die abgetretenen Forderungen und deren Schuldner bekannt gibt, alle zum Einzug erforderlichen Angaben macht, die dazugehörigen Unterlagen aushändigt und den Schuldnern die Abtretung mitteilt, soweit nicht bereits durch den Lieferer geschehen.
Wird der Liefergegenstand zusammen mit anderen Waren, die dem Lieferanten nicht gehören, weiterveräußert, gilt die Forderung des Bestellers gegen den Abnehmer in Höhe des zwischen Lieferer und Besteller vereinbarten Lieferpreises als abgetreten.
3. Der Besteller darf den Liefergegenstand weder verpfänden noch zur Sicherheit übereignen.
4. Der Lieferer ist berechtigt, den Liefergegenstand auf Kosten des Bestellers gegen Diebstahl, Bruch-, Feuer-, Wasser- und sonstige Schäden zu versichern, sofern nicht der Besteller selbst die Versicherung nachweislich abgeschlossen hat.
5. Wird im Zusammenhang mit der Bezahlung des Kaufpreises durch den Besteller eine wechselmäßige Haftung des Lieferers begründet, so erlöschen der Eigentumsvorbehalt, einschließlich seiner vereinbarten Sonderformen, oder sonstige zur Zahlungssicherung vereinbarte Sicherheiten nicht vor Einlösung des Wechsels durch den Besteller als Bezogenem.
6. Der Antrag auf Eröffnung des Insolvenzverfahrens berechtigt den Lieferer vom Vertrag zurückzutreten und die sofortige Rückgabe des Liefergegenstandes zu verlangen.

VI. Mängelansprüche

Für Sach- und Rechtsmängel der Lieferung haftet der Lieferer unter Ausschluss weiterer Ansprüche – vorbehaltlich Abschnitt VII – wie folgt:

Sachmängel

1. Alle diejenigen Teile sind nach Wahl des Lieferers nachzubessern oder mangelfrei zu ersetzen, die sich infolge eines vor dem Ge-

fährübergang liegenden Umstandes als mangelhaft herausstellen.

Die Feststellung solcher Mängel ist dem Lieferer unverzüglich schriftlich anzuzeigen. Ersetzte Teile werden Eigentum des Lieferers.

2. Zur Vornahme aller dem Lieferer notwendig erscheinenden Nachbesserungen und Ersatzlieferungen hat der Besteller nach Verständigung mit dem Lieferer die erforderliche Zeit und Gelegenheit zu geben; andernfalls ist der Lieferer von der Haftung für die daraus entstehenden Folgen befreit. Nur in dringenden Fällen der Gefährdung der Betriebssicherheit bzw. zur Abwehr unverhältnismäßig großer Schäden, wobei der Lieferer sofort zu verständigen ist, hat der Besteller das Recht, den Mangel selbst oder durch Dritte beseitigen zu lassen und vom Lieferer Ersatz der erforderlichen Aufwendungen zu verlangen.
3. Der Lieferer trägt – soweit sich die Beanstandung als berechtigt herausstellt – die unmittelbaren Kosten der Nachbesserung bzw. der Ersatzlieferung einschließlich des Versandes. Er trägt außerdem die Kosten des Aus- und Einbaus sowie die Kosten der etwa erforderlichen Gestellung der notwendigen Monteure und Hilfskräfte einschließlich Fahrtkosten, soweit hierdurch keine unverhältnismäßige Belastung des Lieferers eintritt.
4. Der Besteller hat im Rahmen der gesetzlichen Vorschriften ein Recht zum Rücktritt vom Vertrag, wenn der Lieferer – unter Berücksichtigung der gesetzlichen Ausnahmefälle – eine ihm gesetzte angemessene Frist für die Nachbesserung oder Ersatzlieferung wegen eines Sachmangels fruchtlos verstreichen lässt. Liegt nur ein unerheblicher Mangel vor, steht dem Besteller lediglich ein Recht zur Minderung des Vertragspreises zu. Das Recht auf Minderung des Vertragspreises bleibt ansonsten ausgeschlossen.
5. Weitere Ansprüche bestimmen sich ausschließlich nach Abschnitt VII.2. dieser Bedingungen.
6. Keine Haftung wird insbesondere in folgenden Fällen übernommen:
Ungeeignete oder unsachgemäße Verwendung, fehlerhafte Montage bzw. Inbetriebsetzung durch den Besteller oder Dritte, natürliche Abnutzung, fehlerhafte oder nachlässige Behandlung, nicht ordnungsgemäße Wartung, ungeeignete Betriebsmittel, mangelhafte Bauarbeiten, ungeeigneter Baugrund, chemische, elektrochemische oder elektrische Einflüsse – sofern sie nicht vom Lieferer zu verantworten sind.

Für Mängel des vom Besteller angelieferten Materials haftet der Lieferer nur, wenn er bei Anwendung fachmännischer Sorgfalt die Mängel hätte erkennen müssen. Bei Fertigung nach Zeichnung des Bestellers haftet der Lieferer nur für die zeichnungsmäßige Ausführung.

Werden Sonderwerkzeuge in Auftrag gegeben, so darf die Bestellmenge um 10 %, mindestens jedoch um 2 Stück über- oder unterschritten werden.

7. Bessert der Besteller oder ein Dritter unsachgemäß nach, besteht keine Haftung des Lieferers für die daraus entstehenden Folgen. Gleiches gilt für ohne vorherige Zustimmung des Lieferers vorgenommene Änderungen des Liefergegenstandes.

Rechtsmängel

8. Führt die Benutzung des Liefergegenstandes zur Verletzung von gewerblichen Schutzrechten oder Urheberrechten im Inland, wird der Lieferer auf seine Kosten dem Besteller grundsätzlich das Recht zum weiteren Gebrauch verschaffen oder den Liefergegenstand in für den Besteller zumutbarer Weise derart modifizieren, dass die Schutzrechtsverletzung nicht mehr besteht. Ist dies zu wirtschaftlich angemessenen Bedingungen oder in angemessener Frist nicht möglich, ist der Besteller zum Rücktritt vom Vertrag berechtigt. Unter den genannten Voraussetzungen steht auch dem Lieferer ein Recht zum Rücktritt vom Vertrag zu. Darüber hinaus wird der Lieferer den Besteller von unbestrittenen oder rechtskräftig festgestellten Ansprüchen der betreffenden Schutzrechtsinhaber freistellen.
9. Die in Abschnitt VI.8. genannten Verpflichtungen des Lieferers sind vorbehaltlich Abschnitt VII.2. für den Fall der Schutz oder Urheberrechtsverletzung abschließend.
Sie bestehen nur, wenn
 - der Besteller den Lieferer unverzüglich von geltend gemachten Schutz- oder Urheberrechtsverletzungen unterrichtet,
 - der Besteller den Lieferer in angemessenem Umfang bei der Abwehr der geltend gemachten Ansprüche unterstützt bzw. dem Lieferer die Durchführung der Modifizierungsmaßnahmen gemäß Abschnitt VI.8. ermöglicht,
 - dem Lieferer alle Abwehrmaßnahmen einschließlich außergerichtlicher Regelungen vorbehalten bleiben,
 - der Rechtsmangel nicht auf einer Anweisung des Bestellers beruht und
 - die Rechtsverletzung nicht dadurch verursacht wurde, dass der Besteller den Liefergegenstand eigenmächtig geändert oder in einer nicht vertragsgemäßen Weise verwendet hat.
10. Der Besteller übernimmt für die von ihm beizubringenden Unterlagen, wie Zeichnungen, Lehren, Muster oder dgl., die alleinige Verantwortung. Der Besteller hat dafür einzustehen, dass von ihm vorgelegte Ausführungszeichnungen in Schutzrechte Dritter nicht eingreifen. Der Lieferer ist dem Besteller gegenüber nicht zur Prüfung verpflichtet, ob durch die Abgabe von Angeboten auf Grund ihm eingesandter Ausführung irgendwelche Schutzrechte Dritter verletzt werden. Ergibt sich trotzdem aus anspruchsbegründenden Tatsachen eine Haftung des Lieferers, so hat der Besteller ihn schadlos zu halten.



VII. Haftung des Lieferers, Haftungsausschluss

1. Wenn der Liefergegenstand infolge vom Lieferer schuldhaft unterlassener oder fehlerhafter Vorschläge oder Beratungen, die vor oder nach Vertragsschluss erfolgten, oder durch die schuldhaft Verletzung anderer vertraglicher Nebenverpflichtungen – insbesondere Anleitung für Bedienung und Wartung des Liefergegenstandes – vom Besteller nicht vertragsgemäß verwendet werden kann, so gelten unter Ausschluss weiterer Ansprüche des Bestellers die Regelungen der Abschnitte VI und VII.2.
2. Für Schäden, die nicht am Liefergegenstand selbst entstanden sind, haftet der Lieferer – aus welchen Rechtsgründen auch immer – nur
 - bei Vorsatz,
 - bei grober Fahrlässigkeit des Inhabers/der Organe oder leitender Angestellter,
 - bei schuldhafter Verletzung von Leben, Körper, Gesundheit,
 - bei Mängeln, die er arglistig verschwiegen hat,
 - im Rahmen einer Garantiezusage,
 - bei Mängeln des Liefergegenstandes, soweit nach Produktionshaftungsgesetz für Personen- oder Sachschäden an privat genutzten Gegenständen gehaftet wird.

Bei schuldhafter Verletzung wesentlicher Vertragspflichten haftet der Lieferer auch bei grober Fahrlässigkeit nicht leitender Angestellter und bei leichter Fahrlässigkeit, in letzterem Fall begrenzt auf den vertrags-

typischen, vernünftigerweise vorhersehbaren Schaden.

Weitere Ansprüche sind ausgeschlossen.

VIII. Verjährung

Alle Ansprüche des Bestellers – aus welchen Rechtsgründen auch immer – verjähren in 12 Monaten. Für Schadensersatzansprüche nach Abschnitt VII.2. gelten die gesetzlichen Fristen. Sie gelten auch für Mängel eines Bauwerks oder für Liefergegenstände, die entsprechend ihrer üblichen Verwendungsweise für ein Bauwerk verwendet wurden und dessen Mangelhaftigkeit verursacht haben.

IX. Softwarenutzung

Soweit im Lieferumfang Software enthalten ist, wird dem Besteller ein nicht ausschließliches Recht eingeräumt, die gelieferte Software einschließlich ihrer Dokumentationen zu nutzen.

Sie wird zur Verwendung auf dem dafür bestimmten Liefergegenstand überlassen.

Eine Nutzung der Software auf mehr als einem System ist untersagt.

Der Besteller darf die Software nur im gesetzlich zulässigen Umfang (§§ 69 a ff. UrhG) vervielfältigen, überarbeiten, übersetzen oder von dem Objektcode in den Quellcode umwandeln. Der Besteller verpflichtet sich, Herstellerangaben – insbesondere Copyright-Vermerke – nicht zu entfernen oder ohne vorherige ausdrückliche Zustimmung des Lieferers zu verändern.

Alle sonstigen Rechte an der Software und den Dokumentationen einschließlich der Kopien bleiben beim Lieferer bzw. beim Softwarelieferanten. Die Vergabe von Unterlizenzen ist nicht zulässig.

X. Anwendbares Recht, Gerichtsstand

1. Für alle Rechtsbeziehungen zwischen dem Lieferer und dem Besteller gilt ausschließlich das für die Rechtsbeziehungen inländischer Parteien untereinander maßgebliche Recht der Bundesrepublik Deutschland.
2. Gerichtsstand ist das für den Sitz des Lieferers zuständige Gericht. Der Lieferer ist jedoch berechtigt, am Hauptsitz des Bestellers Klage zu erheben.

XI. Besondere Bedingungen für Bearbeitungsverträge (Fertigstellung, Aufarbeitung, Umarbeitung oder Wiederherstellung von Werkzeugen)

Ergänzend zu oder abweichend von den Lieferbedingungen gilt für Bearbeitungsverträge:

1. Für das Verhalten des an den Bearbeiter eingesandten Materials übernimmt dieser keine Haftung. Sein Anspruch auf Vergütung bleibt unberührt.
2. Wird das Material bei der Bearbeitung durch Verschulden des Bearbeiters unbrauchbar, entfällt sein Vergütungsanspruch.

Der Schadensersatzanspruch des Bestellers richtet sich nach Abschnitt VII.2. der Lieferbedingungen.



A		
A0101001	G (BSP)	174
A0101001	M	90
A0101001	MF	130-131
A0101001	UNF	160
A0101051	M-LH	90
A0101051	MF-LH	130-131
A0102501	M	91
A0102501	W zyl	199
A0102521	M „6GX“	91
A0121001	M	90
A0181000	NPT	189
A0181000	NPTF	193
A0181000	Rc (BSPT)	197
A0181000	W keg	198
A0191000	NPT	189
A0201000	M	90
A0203000	M	91
A0221000	M	90
A0451000	M	91
A0501000	M	91
A0513500	M	91
A6622501	G (BSP)	178
A6622501	MF	138
A6622501	Rp (BSPP)	181
A6622521	MF „6GX“	138
A6622531	G (BSP) „+0,05“	178
A6622531	Rp (BSPP) „+0,05“	181
A662254A	G (BSP) „+0,1“	178
A662254A	MF „+0,1“	138

B		
B0100501	M	49
B0100501	MF	104
B0100501	UNC	141
B0100501	UNF	153
B0101001	BSF	206
B0101001	M	36
B0101001	MF	102
B0101051	MF-LH	102
B0102000	LK-M	228
B0102001	M	45
B0102501	M	48
B0109101	M	50
B0109201	M	45
B0109401	M	53
B010J601	M	47
B010J901	G (BSP)	166
B010J901	M	51
B010J901	MF	104
B010K101	G (BSP)	167
B010K101	M	52
B010K101	MF	105
B010R501	M	45
B010T001	M	47
B0119401	M	53
B011R501	M	45
B0121001	M	36

B016K101	G (BSP)	167
B016K101	M	52
B016K101	MF	105
B0181000	NPT	185
B0181000	NPTF	191
B0183000	NPT	185
B0183000	NPTF	191
B0183000	Rc (BSPT)	195
B0193000	NPT	185
B0201000	M	37
B0201000	UNC	140
B0201000	UNF	152
B0201010	UNC „3B“	140
B0201010	UNF „3B“	152
B0201020	M „6G“	38
B0201030	M „7G“	38
B0201400	M	37
B0201420	M „6G“	38
B0201430	M „7G“	38
B0203000	BSW	201
B0203000	EG M (STI)	216
B0203000	EG UNC (STI)	220
B0203000	EG UNF (STI)	224
B0203000	LK-M	228
B0203000	M	41
B0203000	UNC	141
B0203000	UNF	153
B0203010	M „4H“	41
B0203020	M „6G“	41
B0203030	M „7G“	42
B0203050	M-LH	42
B0203100	BSW	201
B0203100	EG M (STI)	216
B0203100	EG UNC (STI)	220
B0203100	EG UNF (STI)	224
B0203100	LK-M	228
B0203100	M	41
B0203100	MF	103
B0203100	UNC	141
B0203100	UNF	153
B0203110	M „4H“	41
B0203120	M „6G“	41
B0203130	M „7G“	42
B0203150	M-LH	43
B0204500	EG M (STI)	217
B0204500	M	46
B0208400	M	36
B0208400	MF	102
B0208410	M „4H“	37
B0208420	M „6G“	37
B0208430	M „7G“	37
B0208450	M-LH	37
B0208900	M	36
B0208900	MF	102
B0208900	UNC	140
B0208900	UNF	152
B0208910	M „4H“	37
B0208920	M „6G“	37
B0208930	M „7G“	37
B0208950	M-LH	37
B0208E01	M	39
B0208E01	MF	102
B0208F01	M	54
B0208F01	MF	106
B0208F21	M „6GX“	55

B020A601	M	54
B020A601	MF	106
B020A621	M „6GX“	55
B020C000	M	38
B020C300	BSW	201
B020C300	EG M (STI)	216
B020C300	EG UNC (STI)	220
B020C300	EG UNF (STI)	224
B020C300	LK-M	228
B020C300	M	41
B020C300	MF	103
B020C300	UNC	141
B020C300	UNF	153
B020C310	M „4H“	41
B020C320	M „6G“	42
B020C330	M „7G“	42
B020C350	M-LH	43
B020K500	M	36
B020S800	EG M (STI)	217
B020S800	M	46
B0223000	M	43
B0306001	M	48
B0309601	M	49
B0309611	MJ	210
B0309611	UNJC	212
B0309611	UNJF	214
B030J401	M	49
B030J411	MJ	211
B030J411	UNJC	213
B030J411	UNJF	215
B0401400	M	39
B040V401	M	49
B0451000	M	39
B0453701	M	55
B0456001	M	49
B0459601	M	49
B0459611	MJ	210
B0459611	UNJC	212
B0459611	UNJF	214
B0461000	M	39
B046L801	M	48
B0501000	BSW	201
B0501000	M	39
B0501000	MF	103
B0501000	UNC	140
B0501000	UNF	152
B0501010	M „4H“	39
B0501010	MF „4H“	103
B0501010	UNC „3B“	141
B0501010	UNF „3B“	153
B0501020	M „6G“	39
B0501030	M „7G“	40
B0501050	M-LH	40
B0501400	M	39
B0501400	MF	103
B0501400	UNC	140
B0501400	UNF	152
B0501410	M „4H“	39
B0501420	M „6G“	39
B0501430	M „7G“	40
B0501450	M-LH	40
B0503000	BSW	202
B0503000	M	43
B0503000	MF	103
B0503000	UNC	141

B0503000	UNF	153
B0503010	M „4H“	43
B0503020	M „6G“	43
B0503030	M „7G“	43
B0503050	M-LH	44
B0503500	EG M (STI)	217
B0503500	M	58
B0503500	UNC	143
B0503530	UNC „+0,05“	143
B0503700	M	58
B0504500	M	46
B050C300	BSW	202
B050C300	M	43
B050C300	MF	103
B050C300	UNC	141
B050C300	UNF	153
B050C310	M „4H“	43
B050C320	M „6G“	43
B050C330	M „7G“	44
B050C350	M-LH	44
B050C400	M	58
B050S800	EG M (STI)	217
B050S800	EG UNC (STI)	221
B050S800	EG UNF (STI)	225
B050S800	LK-M	229
B050S800	M	46
B050S810	MJ	210
B050S810	UNJC	212
B050S810	UNJF	214
B0513500	EG M (STI)	217
B0513500	EG UNC (STI)	221
B0513500	EG UNF (STI)	225
B0513500	LK-M	229
B0513500	M	59
B0513500	MF	107
B0513500	UNC	143
B0513500	UNF	155
B0513520	M „6G“	59
B0513520	MF „6G“	107
B0513530	UNF „+0,05“	155
B0513700	EG M (STI)	217
B0513700	EG UNC (STI)	221
B0513700	EG UNF (STI)	225
B0513700	LK-M	229
B0513700	M	59
B0513700	MF	107
B0513700	UNC	143
B0513700	UNF	155
B0513720	M „6G“	59
B0513720	MF „6G“	107
B051C400	M	59
B051S800	M	46
B0601000	M	40
B0601400	M	41
B0603000	M	44
B060C300	M	44
B0653501	M	59
B0653540	M „+0,1“	59
B0653701	M	59
B0911000	M	278
B0911300	M	278
B0911400	LK-M	304
B0911400	M	278
B0911400	MF	294
B0911400	UNC	299



B0911400	UNF	301	B5059500	MF	295	B583A601	M	57	C0203000	EG UNC (STI)	222
B0911420	M „6GX“	279	B505Q800	M	285	B583A621	M „6GX“	58	C0203000	EG UNF (STI)	226
B0921000	M	278	B505Q800	MF	295	B670J400	NPT	186	C0203000	G (BSP)	169
B0921300	M	278	B519Q200	M	281	B670J400	NPTF	191	C0203000	LK-M	230
B0921400	LK-M	304	B519Y700	M	281	B8170901	M	47	C0203000	M	68
B0921400	M	279	B519Z700	M	283				C0203000	MF	115
B0921400	MF	294	B5216F00	M	279				C0203000	UNC	145
B0921400	UNC	299	B5217F00	M	279				C0203000	UNF	157
B0921400	UNF	301	B521Q200	M	281				C0203010	M „4H“	68
B0921420	M „6GX“	279	B521W700	M	283				C0203010	MF „4H“	115
B0963701	M	55	B521Y700	M	281				C0203020	M „6G“	69
B0973500	M	59	B521Z700	M	283				C0203020	MF „6G“	116
B0973700	M	59	B521Z700	MF	295				C0203030	M „7G“	69
B0983701	M	55	B521Z700	UNC	299				C0203050	M-LH	69
B0989501	M	47	B521Z700	UNF	301				C0203100	BSW	203
B098Q801	M	47	B521Z720	M „6GX“	283				C0203100	EG M (STI)	218
B099C400	M	58	B5236F00	M	279				C0203100	EG UNC (STI)	222
B1069101	M	50	B5237F00	M	279				C0203100	EG UNF (STI)	226
B1069401	M	53	B523Q200	M	281				C0203100	G (BSP)	169
B106R501	M	45	B523W700	M	283				C0203100	LK-M	230
B1088F01	M	54	B523Y700	M	281				C0203100	M	68
B1088F21	M „6GX“	55	B523Z700	M	283				C0203100	MF	115
B108A601	M	54	B523Z700	MF	295				C0203100	UNC	145
B108A621	M „6GX“	55	B523Z700	UNC	299				C0203100	UNEF	165
B1099401	M	54	B523Z700	UNF	301				C0203100	UNF	157
B1099501	M	47	B523Z800	M	284				C0203110	M „4H“	68
B109R501	M	45	B526Q200	M	281				C0203110	MF „4H“	115
B1583000	NPT	186	B526Z700	M	283				C0203120	M „6G“	69
B1583000	NPTF	191	B5296A00	M	280				C0203120	MF „6G“	116
B1593000	NPT	186	B529Q200	M	282				C0203130	M „7G“	69
B1950501	M	50	B529Y700	M	281				C0203150	M-LH	69
B1950901	M	50	B529Z700	M	283				C0204500	M	73
B1950901	MF	104	B5316A00	M	280				C0208400	G (BSP)	168
B1959101	M	50	B5316F00	M	280				C0208400	M	64
B1959401	M	53	B5317F00	M	279				C0208400	MF	108-109
B195R501	M	45	B531Q200	M	282				C0208410	M „4H“	65
B1969401	M	53	B531Y700	M	281				C0208410	MF „4H“	108-109
B1969501	M	47	B531Z700	M	283				C0208420	M „6G“	65
B196R501	M	45	B531Z800	M	284				C0208420	MF „6G“	110
B1970100	M	279	B533Q200	M	282				C0208430	M „7G“	65
B2100501	M	63	B535P300	M	279				C0208450	M-LH	65
B2201000	M	62	B544Z700	M	286				C0208450	MF-LH	110
B2203000	M	63	B555Z700	M	286				C0208900	G (BSP)	168
B220C300	M	63	B5760F01	M	56				C0208900	M	64
B2401400	M	62	B5760F01	UNC	142				C0208900	MF	108-109
B2461000	M	62	B5760F01	UNF	154				C0208900	UNC	144
B2501000	M	62	B5760F21	M „6GX“	57				C0208900	UNF	156
B2503000	M	63	B576A601	M	56				C0208910	M „4H“	64
B250C300	M	63	B576A601	UNC	142				C0208910	MF „4H“	108-109
B3159401	M	60	B576A601	UNF	154				C0208920	M „6G“	65
B3169401	M	60	B576A621	M „6GX“	57				C0208920	MF „6G“	110
B3179401	M	60	B5810F01	M	56				C0208930	M „7G“	65
B3189401	M	60	B5810F21	M „6GX“	57				C0208950	M-LH	65
B3208F01	M	61	B581A601	M	56				C0208950	MF-LH	110
B3258F01	M	61	B581A621	M „6GX“	57				C0208E01	M	65
B3600F01	M	61	B5820F01	M	56				C0208E01	MF	111-112
B3650F01	M	61	B5820F01	UNC	142				C0208F01	M	77
B4053701	M	55	B5820F01	UNF	154				C0208F01	MF	121
B4093701	M	63	B5820F21	M „6GX“	57				C0208F21	M „6GX“	77
B4253701	M	55	B582A601	M	57				C020A601	M	77
B438J401	M	49	B582A601	UNC	142				C020A601	MF	121
B438J411	MJ	211	B582A601	UNF	154				C020A621	M „6GX“	77
B438J411	UNJC	213	B582A621	M „6GX“	57				C020C300	BSW	203
B438J411	UNJF	215	B5830F01	M	57				C020C300	EG M (STI)	218
B5059500	M	285	B5830F21	M „6GX“	57				C020C300	EG UNC (STI)	222

C

C0100501	G (BSP)	170
C0100501	M	75
C0100501	MF	118
C0100501	Pg	209
C0100501	UNC	145
C0100501	UNF	157
C0101001	BSF	207
C0101001	G (BSP)	168
C0101001	M	64
C0101001	MF	108-109
C0101001	NPSF	183
C0101001	NPSM	182
C0101001	Pg	209
C0101001	Rp (BSPP)	179
C0101001	UNEF	164
C0102000	LK-M	230
C0102001	M	71
C0102001	MF	117
C0109101	G (BSP)	170
C0109101	M	75
C0109101	MF	119
C0109201	M	71
C0109201	MF	117
C0109401	M	76
C0109401	MF	119
C010J901	G (BSP)	171
C010J901	M	75
C010J901	MF	119
C010R501	M	72
C010R501	MF	117
C0119401	M	76
C0119401	MF	120
C011R501	M	72
C011R501	MF	117
C0121001	M	64
C0181000	NPT	187
C0181000	NPTF	192
C0183000	NPT	187
C0183000	NPTF	192
C0183000	Rc (BSPT)	196
C0193000	NPT	187
C0201000	G (BSP)	168
C0201000	M	65
C0201000	MF	111-112
C0201000	UNC	144
C0201000	UNEF	164
C0201000	UNF	156
C0201010	UNC „3B“	144
C0201010	UNF „3B“	156
C0201400	G (BSP)	168
C0201400	M	65
C0201400	MF	111-112
C0203000	BSW	203
C0203000	EG M (STI)	218



C020C300	EG UNF (STI)	226	C0503030	M „7G“	71	C0803001	M	84	C2401400	M	86
C020C300	G (BSP)	169	C0503050	M-LH	71	C0803001	MF	126-127	C2461000	M	86
C020C300	LK-M	230	C0503500	EG M (STI)	219	C0803009	M	84	C2501000	M	86
C020C300	M	68	C0503500	M	81	C0803009	MF	126-127	C2503000	M	87
C020C300	MF	115	C0503500	UNC	147	C0803101	G (BSP)	173	C250C300	M	87
C020C300	UNC	145	C0503530	UNC „+0,05“	147	C0803101	M	85	C3159401	M	83
C020C300	UNEF	165	C0503700	M	81	C0803101	MF	126-127	C3159401	MF	125
C020C300	UNF	157	C0504500	M	73	C0803109	M	85	C3169401	M	83
C020C310	M „4H“	69	C0504500	MF	118	C0803109	MF	126-127	C3169401	MF	125
C020C310	MF „4H“	116	C050C300	BSW	204	C0911400	G (BSP)	303	C3179401	M	83
C020C320	M „6G“	69	C050C300	G (BSP)	170	C0911400	M	287	C3179401	MF	125
C020C320	MF „6G“	116	C050C300	M	70	C0911400	MF	296	C3189401	M	83
C020C330	M „7G“	69	C050C300	MF	117	C0911400	UNC	300	C3189401	MF	125
C020C350	M-LH	69	C050C300	UNC	145	C0911400	UNF	302	C3208F01	M	83
C020S800	M	73	C050C300	UNF	157	C0921400	G (BSP)	303	C3208F01	MF	125
C0306001	M	73	C050C310	M „4H“	70	C0921400	M	287	C3258F01	M	83
C0309601	M	73	C050C320	M „6G“	71	C0921400	MF	296	C3258F01	MF	125
C030J401	M	74	C050C330	M „7G“	71	C0921400	UNC	300	C3600F01	M	83
C0401400	G (BSP)	169	C050C350	M-LH	71	C0921400	UNF	302	C3600F01	MF	125
C0401400	M	66	C050C400	M	81	C0963701	M	78	C3650F01	M	83
C0451000	G (BSP)	169	C050S800	EG M (STI)	219	C0963701	MF	121	C3650F01	MF	125
C0451000	M	66	C050S800	M	73	C0973500	MF	124	C4053701	M	78
C0451000	MF	111-112	C0513500	EG M (STI)	219	C0973700	M	81	C4053701	MF	121
C0453701	M	78	C0513500	EG UNC (STI)	223	C0973700	MF	124	C4063701	M	89
C0453701	MF	121	C0513500	EG UNF (STI)	227	C0983701	M	78	C4063701	MF	129
C0456001	M	73	C0513500	G (BSP)	172	C0983701	MF	121	C4093701	M	87
C0459601	M	74	C0513500	LK-M	231	C099C400	M	81	C4253701	M	78
C0461000	G (BSP)	169	C0513500	M	81	C1069101	M	75	C4253701	MF	121
C0461000	M	66	C0513500	MF	124	C1069101	MF	119	C4283701	M	89
C0461000	MF	111-112	C0513500	NPSF	183	C1069401	M	76	C4283701	MF	129
C0461000	UNEF	164	C0513500	NPSM	182	C1069401	MF	120	C438J401	M	74
C0501000	BSW	203	C0513500	Rp (BSPP)	180	C106R501	M	72	C4963701	M	88
C0501000	G (BSP)	169	C0513500	UNC	147	C106R501	MF	117	C4963701	MF	128
C0501000	M	66	C0513500	UNF	159	C1088F01	M	77	C4973701	M	88
C0501000	MF	113-114	C0513520	M „6G“	81	C1088F01	MF	121	C4973701	MF	128
C0501000	UNC	144	C0513520	MF „6G“	124	C1088F21	M „6GX“	77	C500W700	M	292
C0501000	UNEF	164	C0513530	G (BSP) „+0,05“	172	C108A601	M	77	C5059500	M	290
C0501000	UNF	156	C0513530	UNF „+0,05“	159	C108A601	MF	121	C5059500	MF	298
C0501010	M „4H“	67	C0513700	EG M (STI)	219	C108A621	M „6GX“	77	C505Q800	M	290
C0501010	MF „4H“	113-114	C0513700	EG UNC (STI)	223	C1099401	M	77	C505Q800	MF	298
C0501010	UNC „3B“	145	C0513700	EG UNF (STI)	227	C1099401	MF	120	C519Z700	M	289
C0501010	UNF „3B“	157	C0513700	G (BSP)	172	C109R501	M	73	C5216F00	M	288
C0501020	M „6G“	67	C0513700	LK-M	231	C109R501	MF	118	C5216F00	MF	297
C0501030	M „7G“	67	C0513700	M	81	C1583000	NPT	188	C5217F00	M	287
C0501050	M-LH	67	C0513700	MF	124	C1583000	NPTF	192	C5217F00	MF	296
C0501050	MF-LH	113-114	C0513700	NPSF	183	C1593000	NPT	188	C521W700	M	289
C0501400	G (BSP)	169	C0513700	NPSM	182	C1950501	M	75	C521W700	MF	297
C0501400	M	66	C0513700	Rp (BSPP)	180	C1950501	MF	119	C521Z700	G (BSP)	303
C0501400	MF	113-114	C0513700	UNC	147	C1950901	M	75	C521Z700	M	289
C0501400	UNC	144	C0513700	UNF	159	C1950901	MF	119	C521Z700	MF	297
C0501400	UNF	156	C0513720	M „6G“	82	C1959101	M	75	C521Z700	UNC	300
C0501410	M „4H“	67	C0513720	MF „6G“	125	C1959101	MF	119	C521Z700	UNF	302
C0501420	M „6G“	67	C051C400	M	81	C1959401	M	76	C5236F00	M	288
C0501430	M „7G“	67	C0539401	M	89	C1959401	MF	119	C5236F00	MF	297
C0501450	M-LH	67	C0539401	MF	129	C195R501	M	72	C5237F00	M	287
C0501450	MF-LH	113-114	C0579401	M	88	C195R501	MF	117	C5237F00	MF	296
C0503000	BSW	204	C0579401	MF	128	C1960901	G (BSP)	170	C523W700	M	289
C0503000	G (BSP)	169	C0601000	M	67	C1969401	M	76	C523W700	MF	297
C0503000	M	70	C0601400	M	67	C1969401	MF	120	C523Z700	G (BSP)	303
C0503000	MF	116	C0603000	M	71	C196R501	M	72	C523Z700	M	289
C0503000	UN-8	148	C060C300	M	71	C196R501	MF	117	C523Z700	MF	297
C0503000	UNC	145	C0653501	M	82	C2100501	M	87	C523Z700	UNC	300
C0503000	UNF	157	C0653540	M „+0,1“	82	C2201000	M	86	C523Z700	UNF	302
C0503010	M „4H“	70	C0653701	M	82	C2203000	M	87	C526Z700	M	289
C0503020	M „6G“	70	C0803001	G (BSP)	173	C220C300	M	87	C529Z700	M	289



C5316F00	M	288
C5316F00	MF	297
C5317F00	M	287
C5317F00	MF	296
C531Z700	M	289
C544Z700	M	291
C555Z700	M	291
C5760F01	G (BSP)	171
C5760F01	M	79
C5760F01	MF	122
C5760F01	UNC	146
C5760F01	UNF	158
C5760F21	M „6GX“	79
C576A601	G (BSP)	171
C576A601	M	79
C576A601	MF	122
C576A601	UNC	146
C576A601	UNF	158
C576A621	M „6GX“	79
C5810F01	G (BSP)	171
C5810F01	M	79
C5810F01	MF	122
C5810F21	M „6GX“	80
C581A601	G (BSP)	171
C581A601	M	79
C581A601	MF	122
C581A621	M „6GX“	80
C5820F01	G (BSP)	171
C5820F01	M	79
C5820F01	MF	122
C5820F01	UNC	146
C5820F01	UNF	158
C5820F21	M „6GX“	80
C582A601	G (BSP)	171
C582A601	M	79
C582A601	MF	123
C582A601	UNC	146
C582A601	UNF	158
C582A621	M „6GX“	80
C5830F01	G (BSP)	171
C5830F01	M	79
C5830F01	MF	123
C5830F21	M „6GX“	80
C583A601	G (BSP)	171
C583A601	M	79
C583A601	MF	123
C583A621	M „6GX“	81
C594W700	M	293
C595W700	M	293
C599W700	M	292

D

D0101000	BSF	495
D0101000	BSW	494
D0101000	G (BSP)	489
D0101000	M	478
D0101000	MF	484
D0101000	Tr	496
D0101000	Tr-F	497
D0101000	UNC	486

D0101000	UNEF	488
D0101000	UNF	487
D0101030	M „6e“	479
D0101030	MF „6e“	485
D0101050	M-LH	479
D0101050	MF-LH	485
D0101500	G (BSP)	489
D0101500	M	478
D0101500	MF	484
D0101500	UNC	486
D0101500	UNEF	488
D0101500	UNF	487
D0102500	G (BSP)	489
D0102500	M	479
D0102500	MF	485
D0103000	M	479
D0103000	MF	485
D0103500	M	479
D0191000	NPT	491
D0191000	NPTF	492
D0191000	R (BSPT)	493
D0301500	M	481
D0302500	G (BSP)	490
D0361500	M	480
D0401000	M	482

F

F010... SFM	734-735
F018... SFM-L-DZ	737-738
F019... SFM-L-DZ	737-738
F020... SFM-L-DZ	737-738
F033... HF	748-749
F033... HF/HD/Spezial	750-751
F040... GR	744, 746
F040... GR, GR-S	746
F041... GR-S	745
F056... EM	758-759
F056... EM/IKZ	761
F057... EM-U	764-765
F057... EM-U/IKZ	767
F058... EM-L	768-769
F059... EM-UL	771-772
F062... EM-SE	777
F063... HE	753
F063... HE/IKZZ	752
F064... HE	752-753
F080... EM-E	760
F081... EM-U-E	766
F082... EM-L-E	770
F083... EM-UL-E	773
F086... EM-Z/ER/IKZ	774
F089... EM-R	778
F090... A-E	795
F090... A-EM	795
F090... A-EP	795
F090... A-SW	795
F090... DEU	798
F090... TORCO-FIX	795
F091... VEU	799
F092... AEU	798
F093... VS	798
F094... DS/ER	789
F094... ER	787
F094... ER-GB	786
F094... GR	746
F094... Hi-Q/ER	791
F094... Hi-Q/ERBC	792
F094... Hi-Q/ERC	791
F094... Hi-Q/ERM	790
F094... Hi-Q/ERMC	790
F094... KS/ER	789
F094... PCM ET1	788
F094... PGR-GB	796
F211... SFM-NP	736
F256... EM-E-Lock	762-763
F310... KSN/HD	698-705
F313... KSN/Synchro	711-713
F315... Softsynchro®	662-679
F315... Zubehör · Accessories	793
F322... Softsynchro®/PGR	680-681
F323... KSN/HD/ER	706-708
F323... Zubehör · Accessories	794
F324... KSN/HD/PGR	709-710
F330... KSN	688-697
F330... Zubehör · Accessories	780-783
F338... SWITCH-MASTER®	740-741
F347... KSN/MQL	727, 729
F348... KSN/MQL	728
F349... Softsynchro®/MMS	716, 718
F350... EM-L/ER/IKZ	775
F350... Zubehör · Accessories	794
F351... Softsynchro®/MMS	717
F354... Softsyn.® Mod./IKZ	667
F355... Softsyn.® Mod./MQL	720-725
F355... Zubehör · Accessories	782-784
F356... EM/PGR/IKZ	776
F374... Speedsyn.® Mod./IKZ	684-685
F374... Zubehör · Accessories	793
F375... Speedsyn.® Mod./MQL	686, 726
F375... Zubehör · Accessories	785
F449... EM/MQL	730
F450... EM-Z/MQL	731-732
FZ111000	243
FZ111010	243
FZ111100	244
FZ111300	240
FZ111310	240
FZ112600	241
FZ112610	241
FZ115480	242
FZ115490	242
FZ115500	242
FZ115510	242
FZ115520	242
FZ115530	242
FZ191015	239
FZ191115	239
FZ191215	239
FZ191315	239
FZ191415	239
FZ191515	239
FZ201000	498

G

G0037165	1:16	200
G0037175	1:16	200
G0303000	Tr	233
G0303050	Tr-LH	233
G0321000	Tr-F	235
G0321050	Tr-F-LH	235
G0323000	Tr-F	235
G0351000	Tr	232
G0351050	Tr-LH	232
G0401000	Rd	237
G0442500	Tr	234
G0442500	Tr-F	236
GF161121	M, MF	385
GF161126	M, MF	385
GF161131	M, MF	385
GF161136	M, MF	385
GF161151	M, MF	385
GF161156	M, MF	385
GF161211	M, MF	385
GF161216	M, MF	385
GF161421	M, MF	385
GF161426	M, MF	385
GF161431	M, MF	385
GF161436	M, MF	385
GF161451	M, MF	385
GF161456	M, MF	385
GF161511	M, MF	385
GF161516	M, MF	385
GF161721	M, MF	385
GF161726	M, MF	385
GF161731	M, MF	385
GF161736	M, MF	385
GF161751	M, MF	385
GF161756	M, MF	385
GF161811	M, MF	385
GF161816	M, MF	385
GF162101	M, MF	383
GF162106	M, MF	383
GF162121	G (BSP), Rp (BSPP), W	394
GF162121	M, MF	383
GF162121	Pg	397
GF162126	G (BSP), Rp (BSPP), W	394
GF162126	M, MF	383
GF162126	Pg	397
GF162131	G (BSP), Rp (BSPP), W	394
GF162131	M, MF	383
GF162136	G (BSP), Rp (BSPP), W	394
GF162136	M, MF	383
GF162151	G (BSP), Rp (BSPP), W	394
GF162151	M, MF	383
GF162156	G (BSP), Rp (BSPP), W	394
GF162156	M, MF	383
GF162211	G (BSP), Rp (BSPP), W	394
GF162211	M, MF	383
GF162211	Pg	397
GF162216	G (BSP), Rp (BSPP), W	394
GF162216	M, MF	383
GF162216	Pg	397
GF162311	M, MF	384
GF162311	UN	391
GF162316	M, MF	384
GF162316	UN	391



GF162321	M, MF	384	GF162756	M, MF	383	GF163426	LK-M	398	GF163816	UN	390
GF162321	UN	391	GF162811	G (BSP), Rp (BSPP), W	394	GF163426	M, MF	382	GF165361	G (BSP), Rp (BSPP), W	395
GF162326	M, MF	384	GF162811	M, MF	383	GF163426	Pg	396	GF165361	M, MF	386
GF162326	UN	391	GF162811	Pg	397	GF163426	UN	390	GF165366	G (BSP), Rp (BSPP), W	395
GF162331	M, MF	384	GF162816	G (BSP), Rp (BSPP), W	394	GF163431	G (BSP), Rp (BSPP), W	393	GF165366	M, MF	386
GF162331	UN	391	GF162816	M, MF	383	GF163431	LK-M	398	GF165371	G (BSP), Rp (BSPP), W	395
GF162336	M, MF	384	GF162816	Pg	397	GF163431	M, MF	382	GF165371	M, MF	386
GF162336	UN	391	GF162911	M, MF	384	GF163431	UN	390	GF165376	G (BSP), Rp (BSPP), W	395
GF162351	M, MF	384	GF162911	UN	391	GF163436	G (BSP), Rp (BSPP), W	393	GF165376	M, MF	386
GF162351	UN	391	GF162916	M, MF	384	GF163436	LK-M	398	GF165381	G (BSP), Rp (BSPP), W	395
GF162356	M, MF	384	GF162916	UN	391	GF163436	M, MF	382	GF165381	M, MF	386
GF162356	UN	391	GF162921	M, MF	384	GF163436	UN	390	GF165386	G (BSP), Rp (BSPP), W	395
GF162401	M, MF	383	GF162921	UN	391	GF163451	G (BSP), Rp (BSPP), W	393	GF165386	M, MF	386
GF162406	M, MF	383	GF162926	M, MF	384	GF163451	LK-M	398	GF165391	G (BSP), Rp (BSPP), W	395
GF162421	G (BSP), Rp (BSPP), W	394	GF162926	UN	391	GF163451	M, MF	382	GF165391	M, MF	386
GF162421	M, MF	383	GF162931	M, MF	384	GF163451	UN	390	GF165396	G (BSP), Rp (BSPP), W	395
GF162421	Pg	397	GF162931	UN	391	GF163456	G (BSP), Rp (BSPP), W	393	GF165396	M, MF	386
GF162426	G (BSP), Rp (BSPP), W	394	GF162936	M, MF	384	GF163456	LK-M	398	GF165661	G (BSP), Rp (BSPP), W	395
GF162426	M, MF	383	GF162936	UN	391	GF163456	M, MF	382	GF165661	M, MF	386
GF162426	Pg	397	GF162951	M, MF	384	GF163456	UN	390	GF165666	G (BSP), Rp (BSPP), W	395
GF162431	G (BSP), Rp (BSPP), W	394	GF162951	UN	391	GF163511	G (BSP), Rp (BSPP), W	393	GF165666	M, MF	386
GF162431	M, MF	383	GF162956	M, MF	384	GF163511	LK-M	398	GF165671	G (BSP), Rp (BSPP), W	395
GF162436	G (BSP), Rp (BSPP), W	394	GF162956	UN	391	GF163511	M, MF	382	GF165671	M, MF	386
GF162436	M, MF	383	GF163101	M, MF	382	GF163511	Pg	396	GF165676	G (BSP), Rp (BSPP), W	395
GF162451	G (BSP), Rp (BSPP), W	394	GF163106	M, MF	382	GF163511	UN	390	GF165676	M, MF	386
GF162451	M, MF	383	GF163121	LK-M	398	GF163516	G (BSP), Rp (BSPP), W	393	GF165681	G (BSP), Rp (BSPP), W	395
GF162456	G (BSP), Rp (BSPP), W	394	GF163121	M, MF	382	GF163516	LK-M	398	GF165681	M, MF	386
GF162456	M, MF	383	GF163121	Pg	396	GF163516	M, MF	382	GF165686	G (BSP), Rp (BSPP), W	395
GF162511	G (BSP), Rp (BSPP), W	394	GF163121	UN	390	GF163516	Pg	396	GF165686	M, MF	386
GF162511	M, MF	383	GF163126	LK-M	398	GF163516	UN	390	GF165691	G (BSP), Rp (BSPP), W	395
GF162511	Pg	397	GF163126	M, MF	382	GF163701	M, MF	382	GF165691	M, MF	386
GF162516	G (BSP), Rp (BSPP), W	394	GF163126	Pg	396	GF163706	M, MF	382	GF165696	G (BSP), Rp (BSPP), W	395
GF162516	M, MF	383	GF163126	UN	390	GF163721	LK-M	398	GF165696	M, MF	386
GF162516	Pg	397	GF163131	G (BSP), Rp (BSPP), W	393	GF163721	M, MF	382	GF165961	G (BSP), Rp (BSPP), W	395
GF162611	M, MF	384	GF163131	LK-M	398	GF163721	Pg	396	GF165961	M, MF	386
GF162611	UN	391	GF163131	M, MF	382	GF163721	UN	390	GF165966	G (BSP), Rp (BSPP), W	395
GF162616	M, MF	384	GF163131	UN	390	GF163726	LK-M	398	GF165966	M, MF	386
GF162616	UN	391	GF163136	G (BSP), Rp (BSPP), W	393	GF163726	M, MF	382	GF165971	G (BSP), Rp (BSPP), W	395
GF162621	M, MF	384	GF163136	LK-M	398	GF163726	Pg	396	GF165971	M, MF	386
GF162621	UN	391	GF163136	M, MF	382	GF163726	UN	390	GF165976	G (BSP), Rp (BSPP), W	395
GF162626	M, MF	384	GF163136	UN	390	GF163731	G (BSP), Rp (BSPP), W	393	GF165976	M, MF	386
GF162626	UN	391	GF163151	G (BSP), Rp (BSPP), W	393	GF163731	LK-M	398	GF165981	G (BSP), Rp (BSPP), W	395
GF162631	M, MF	384	GF163151	LK-M	398	GF163731	M, MF	382	GF165981	M, MF	386
GF162631	UN	391	GF163151	M, MF	382	GF163731	UN	390	GF165986	G (BSP), Rp (BSPP), W	395
GF162636	M, MF	384	GF163151	UN	390	GF163736	G (BSP), Rp (BSPP), W	393	GF165986	M, MF	386
GF162636	UN	391	GF163156	G (BSP), Rp (BSPP), W	393	GF163736	LK-M	398	GF165991	G (BSP), Rp (BSPP), W	395
GF162651	M, MF	384	GF163156	LK-M	398	GF163736	M, MF	382	GF165991	M, MF	386
GF162651	UN	391	GF163156	M, MF	382	GF163736	UN	390	GF165996	G (BSP), Rp (BSPP), W	395
GF162656	M, MF	384	GF163156	UN	390	GF163751	G (BSP), Rp (BSPP), W	393	GF165996	M, MF	386
GF162656	UN	391	GF163211	G (BSP), Rp (BSPP), W	393	GF163751	LK-M	398	GF173101	NPT	401
GF162701	M, MF	383	GF163211	LK-M	398	GF163751	M, MF	382	GF173101	NPTF	406
GF162706	M, MF	383	GF163211	M, MF	382	GF163751	UN	390	GF173101	Rc (BSPT)	411
GF162721	G (BSP), Rp (BSPP), W	394	GF163211	Pg	396	GF163756	G (BSP), Rp (BSPP), W	393	GF173106	NPT	401
GF162721	M, MF	383	GF163211	UN	390	GF163756	LK-M	398	GF173106	NPTF	406
GF162721	Pg	397	GF163216	G (BSP), Rp (BSPP), W	393	GF163756	M, MF	382	GF173106	Rc (BSPT)	411
GF162726	G (BSP), Rp (BSPP), W	394	GF163216	LK-M	398	GF163756	UN	390	GF173111	NPT	401
GF162726	M, MF	383	GF163216	M, MF	382	GF163811	G (BSP), Rp (BSPP), W	393	GF173111	NPTF	406
GF162726	Pg	397	GF163216	Pg	396	GF163811	LK-M	398	GF173111	Rc (BSPT)	411
GF162731	G (BSP), Rp (BSPP), W	394	GF163216	UN	390	GF163811	M, MF	382	GF173116	NPT	401
GF162731	M, MF	383	GF163401	M, MF	382	GF163811	Pg	396	GF173116	NPTF	406
GF162736	G (BSP), Rp (BSPP), W	394	GF163406	M, MF	382	GF163811	UN	390	GF173116	Rc (BSPT)	411
GF162736	M, MF	383	GF163421	LK-M	398	GF163816	G (BSP), Rp (BSPP), W	393	GF173131	NPT	401
GF162751	G (BSP), Rp (BSPP), W	394	GF163421	M, MF	382	GF163816	LK-M	398	GF173131	NPTF	406
GF162751	M, MF	383	GF163421	Pg	396	GF163816	M, MF	382	GF173131	Rc (BSPT)	411
GF162756	G (BSP), Rp (BSPP), W	394	GF163421	UN	390	GF163816	Pg	396	GF173136	NPT	401



GF173136	NPTF	406	GF175331	NPTF	408	GF193401	Rc (BSPT)	412	GF195606	NPTF	409
GF173136	Rc (BSPT)	411	GF175336	NPT (API-LP)	403	GF193406	NPT	402	GF195611	NPT (API-LP)	404
GF173151	NPT	401	GF175336	NPTF	408	GF193406	NPTF	407	GF195611	NPTF	409
GF173151	NPTF	406	GF175351	NPT (API-LP)	403	GF193406	Rc (BSPT)	412	GF195616	NPT (API-LP)	404
GF173151	Rc (BSPT)	411	GF175351	NPTF	408	GF193411	NPT	402	GF195616	NPTF	409
GF173156	NPT	401	GF175356	NPT (API-LP)	403	GF193411	NPTF	407	GF195631	NPT (API-LP)	404
GF173156	NPTF	406	GF175356	NPTF	408	GF193411	Rc (BSPT)	412	GF195631	NPTF	409
GF173156	Rc (BSPT)	411	GF175601	NPT (API-LP)	403	GF193416	NPT	402	GF195636	NPT (API-LP)	404
GF173401	NPT	401	GF175601	NPTF	408	GF193416	NPTF	407	GF195636	NPTF	409
GF173401	NPTF	406	GF175606	NPT (API-LP)	403	GF193416	Rc (BSPT)	412	GF195651	NPT (API-LP)	404
GF173401	Rc (BSPT)	411	GF175606	NPTF	408	GF193431	NPT	402	GF195651	NPTF	409
GF173406	NPT	401	GF175611	NPT (API-LP)	403	GF193431	NPTF	407	GF195656	NPT (API-LP)	404
GF173406	NPTF	406	GF175611	NPTF	408	GF193431	Rc (BSPT)	412	GF195656	NPTF	409
GF173406	Rc (BSPT)	411	GF175616	NPT (API-LP)	403	GF193436	NPT	402	GF195901	NPT (API-LP)	404
GF173411	NPT	401	GF175616	NPTF	408	GF193436	NPTF	407	GF195901	NPTF	409
GF173411	NPTF	406	GF175631	NPT (API-LP)	403	GF193436	Rc (BSPT)	412	GF195906	NPT (API-LP)	404
GF173411	Rc (BSPT)	411	GF175631	NPTF	408	GF193451	NPT	402	GF195906	NPTF	409
GF173416	NPT	401	GF175636	NPT (API-LP)	403	GF193451	NPTF	407	GF195911	NPT (API-LP)	404
GF173416	NPTF	406	GF175636	NPTF	408	GF193451	Rc (BSPT)	412	GF195911	NPTF	409
GF173416	Rc (BSPT)	411	GF175651	NPT (API-LP)	403	GF193456	NPT	402	GF195916	NPT (API-LP)	404
GF173431	NPT	401	GF175651	NPTF	408	GF193456	NPTF	407	GF195916	NPTF	409
GF173431	NPTF	406	GF175656	NPT (API-LP)	403	GF193456	Rc (BSPT)	412	GF195931	NPT (API-LP)	404
GF173431	Rc (BSPT)	411	GF175656	NPTF	408	GF193701	NPT	402	GF195931	NPTF	409
GF173436	NPT	401	GF175901	NPT (API-LP)	403	GF193701	NPTF	407	GF195936	NPT (API-LP)	404
GF173436	NPTF	406	GF175901	NPTF	408	GF193701	Rc (BSPT)	412	GF195936	NPTF	409
GF173436	Rc (BSPT)	411	GF175906	NPT (API-LP)	403	GF193706	NPT	402	GF195951	NPT (API-LP)	404
GF173451	NPT	401	GF175906	NPTF	408	GF193706	NPTF	407	GF195951	NPTF	409
GF173451	NPTF	406	GF175911	NPT (API-LP)	403	GF193706	Rc (BSPT)	412	GF195956	NPT (API-LP)	404
GF173451	Rc (BSPT)	411	GF175911	NPTF	408	GF193711	NPT	402	GF195956	NPTF	409
GF173456	NPT	401	GF175916	NPT (API-LP)	403	GF193711	NPTF	407	GF243701	M, MF	414
GF173456	NPTF	406	GF175916	NPTF	408	GF193711	Rc (BSPT)	412	GF243706	M, MF	414
GF173456	Rc (BSPT)	411	GF175931	NPT (API-LP)	403	GF193716	NPT	402	GF253101	M, MF	414
GF173701	NPT	401	GF175931	NPTF	408	GF193716	NPTF	407	GF253106	M, MF	414
GF173701	NPTF	406	GF175936	NPT (API-LP)	403	GF193716	Rc (BSPT)	412	GF253701	M, MF	414
GF173701	Rc (BSPT)	411	GF175936	NPTF	408	GF193731	NPT	402	GF253701	UNC, UNF	418
GF173706	NPT	401	GF175951	NPT (API-LP)	403	GF193731	NPTF	407	GF253706	M, MF	414
GF173706	NPTF	406	GF175951	NPTF	408	GF193731	Rc (BSPT)	412	GF253706	UNC, UNF	418
GF173706	Rc (BSPT)	411	GF175956	NPT (API-LP)	403	GF193736	NPT	402	GF26A129	M, MF	416
GF173711	NPT	401	GF175956	NPTF	408	GF193736	NPTF	407	GF26A129	UNC	420
GF173711	NPTF	406	GF193101	NPT	402	GF193736	Rc (BSPT)	412	GF26A129	UNF	420
GF173711	Rc (BSPT)	411	GF193101	NPTF	407	GF193751	NPT	402	GF26A729	M, MF	416
GF173716	NPT	401	GF193101	Rc (BSPT)	412	GF193751	NPTF	407	GF26A729	UNC	420
GF173716	NPTF	406	GF193106	NPT	402	GF193751	Rc (BSPT)	412	GF26A729	UNF	420
GF173716	Rc (BSPT)	411	GF193106	NPTF	407	GF193756	NPT	402	GF273106	M, MF	415
GF173731	NPT	401	GF193106	Rc (BSPT)	412	GF193756	NPTF	407	GF273106	UNC	419
GF173731	NPTF	406	GF193111	NPT	402	GF193756	Rc (BSPT)	412	GF273106	UNF	419
GF173731	Rc (BSPT)	411	GF193111	NPTF	407	GF195301	NPT (API-LP)	404	GF273701	M, MF	415
GF173736	NPT	401	GF193111	Rc (BSPT)	412	GF195301	NPTF	409	GF273706	M, MF	415
GF173736	NPTF	406	GF193116	NPT	402	GF195306	NPT (API-LP)	404	GF273706	UNC	419
GF173736	Rc (BSPT)	411	GF193116	NPTF	407	GF195306	NPTF	409	GF273706	UNF	419
GF173751	NPT	401	GF193116	Rc (BSPT)	412	GF195311	NPT (API-LP)	404	GF283129	M, MF	417
GF173751	NPTF	406	GF193131	NPT	402	GF195311	NPTF	409	GF283729	M, MF	417
GF173751	Rc (BSPT)	411	GF193131	NPTF	407	GF195316	NPT (API-LP)	404	GF303701	M	360
GF173756	NPT	401	GF193131	Rc (BSPT)	412	GF195316	NPTF	409	GF303706	M	361
GF173756	NPTF	406	GF193136	NPT	402	GF195331	NPT (API-LP)	404	GF313701	M	360
GF173756	Rc (BSPT)	411	GF193136	NPTF	407	GF195331	NPTF	409	GF313706	M	361
GF175301	NPT (API-LP)	403	GF193136	Rc (BSPT)	412	GF195336	NPT (API-LP)	404	GF322101	G (BSP)	376
GF175301	NPTF	408	GF193151	NPT	402	GF195336	NPTF	409	GF322101	M	362
GF175306	NPT (API-LP)	403	GF193151	NPTF	407	GF195351	NPT (API-LP)	404	GF322101	MF	368
GF175306	NPTF	408	GF193151	Rc (BSPT)	412	GF195351	NPTF	409	GF322101	UNC	372
GF175311	NPT (API-LP)	403	GF193156	NPT	402	GF195356	NPT (API-LP)	404	GF322101	UNF	374
GF175311	NPTF	408	GF193156	NPTF	407	GF195356	NPTF	409	GF322106	G (BSP)	377
GF175316	NPT (API-LP)	403	GF193156	Rc (BSPT)	412	GF195601	NPT (API-LP)	404	GF322106	M	363
GF175316	NPTF	408	GF193401	NPT	402	GF195601	NPTF	409	GF322106	MF	369
GF175331	NPT (API-LP)	403	GF193401	NPTF	407	GF195606	NPT (API-LP)	404	GF322106	UNC	373



GF322106	UNF	375	GF333101	MF	366	GF422506	UNF	347	GF439246	M	338
GF322401	G (BSP)	376	GF333106	LK-M	379	GF422551	M	336	GF439246	MF	342
GF322401	M	362	GF333106	M	361	GF422556	M	337	GF439248	M	339
GF322401	MF	368	GF333106	MF	367	GF422801	EG M (STI)	350	GF439248	MF	343
GF322401	UNC	372	GF333401	LK-M	378	GF422801	G (BSP)	348	GF439546	M	338
GF322401	UNF	374	GF333401	M	360	GF422801	M	334	GF439546	MF	342
GF322406	G (BSP)	377	GF333401	MF	366	GF422801	MF	340	GF439548	M	339
GF322406	M	363	GF333406	LK-M	379	GF422801	UNC	344	GF439548	MF	343
GF322406	MF	369	GF333406	M	361	GF422801	UNF	346	GF439846	M	338
GF322406	UNC	373	GF333406	MF	367	GF422806	EG M (STI)	351	GF439846	MF	342
GF322406	UNF	375	GF333701	LK-M	378	GF422806	G (BSP)	349	GF439848	M	339
GF322701	G (BSP)	376	GF333701	M	360	GF422806	M	335	GF439848	MF	343
GF322701	M	362	GF333701	MF	366	GF422806	MF	341	GF442201	M	334
GF322701	MF	368	GF333706	LK-M	379	GF422806	UNC	345	GF442201	UNC	344
GF322701	UNC	372	GF333706	M	361	GF422806	UNF	347	GF442206	M	335
GF322701	UNF	374	GF333706	MF	367	GF422851	M	336	GF442206	UNC	345
GF322706	G (BSP)	377	GF335121	M	364	GF422856	M	337	GF442251	M	336
GF322706	M	363	GF335121	MF	370	GF429246	M	338	GF442256	M	337
GF322706	MF	369	GF335126	M	365	GF429248	M	339	GF442501	M	334
GF322706	UNC	373	GF335126	MF	371	GF429546	M	338	GF442501	UNC	344
GF322706	UNF	375	GF335421	M	364	GF429548	M	339	GF442506	M	335
GF323101	M	360	GF335421	MF	370	GF429846	M	338	GF442506	UNC	345
GF323101	MF	366	GF335426	M	365	GF429848	M	339	GF442551	M	336
GF323106	M	361	GF335426	MF	371	GF432201	EG M (STI)	350	GF442556	M	337
GF323106	MF	367	GF335721	M	364	GF432201	G (BSP)	348	GF442801	M	334
GF323401	M	360	GF335721	MF	370	GF432201	M	334	GF442801	UNC	344
GF323401	MF	366	GF335726	M	365	GF432201	MF	340	GF442806	M	335
GF323406	M	361	GF335726	MF	371	GF432201	UNC	344	GF442806	UNC	345
GF323406	MF	367	GF342101	M	362	GF432201	UNF	346	GF442851	M	336
GF323701	M	360	GF342101	UNC	372	GF432206	EG M (STI)	351	GF442856	M	337
GF323701	MF	366	GF342106	M	363	GF432206	G (BSP)	349	GF449246	M	338
GF323706	M	361	GF342106	UNC	373	GF432206	M	335	GF449248	M	339
GF323706	MF	367	GF342401	M	362	GF432206	MF	341	GF449546	M	338
GF332101	G (BSP)	376	GF342401	UNC	372	GF432206	UNC	345	GF449548	M	339
GF332101	M	362	GF342406	M	363	GF432206	UNF	347	GF449846	M	338
GF332101	MF	368	GF342406	UNC	373	GF432251	M	336	GF449848	M	339
GF332101	UNC	372	GF342701	M	362	GF432256	M	337	GF603111	G (BSP), BSW, BSF, W	423
GF332101	UNF	374	GF342701	UNC	372	GF432501	EG M (STI)	350	GF603111	M, MF	423
GF332106	G (BSP)	377	GF342706	M	363	GF432501	G (BSP)	348	GF603111	UN	423
GF332106	M	363	GF342706	UNC	373	GF432501	M	334	GF603117	G (BSP), BSW, BSF, W	423
GF332106	MF	369	GF422201	EG M (STI)	350	GF432501	MF	340	GF603117	M, MF	423
GF332106	UNC	373	GF422201	G (BSP)	348	GF432501	UNC	344	GF603117	UN	423
GF332106	UNF	375	GF422201	M	334	GF432501	UNF	346	GF603142	G (BSP), BSW, BSF, W	424
GF332401	G (BSP)	376	GF422201	MF	340	GF432506	EG M (STI)	351	GF603142	M, MF	424
GF332401	M	362	GF422201	UNC	344	GF432506	G (BSP)	349	GF603147	G (BSP), BSW, BSF, W	424
GF332401	MF	368	GF422201	UNF	346	GF432506	M	335	GF603147	M, MF	424
GF332401	UNC	372	GF422206	EG M (STI)	351	GF432506	MF	341	GF613121	G (BSP), BSW, BSF, W	425
GF332401	UNF	374	GF422206	G (BSP)	349	GF432506	UNC	345	GF613121	M, MF	425
GF332406	G (BSP)	377	GF422206	M	335	GF432506	UNF	347	GF613127	G (BSP), BSW, BSF, W	425
GF332406	M	363	GF422206	MF	341	GF432551	M	336	GF613127	M, MF	425
GF332406	MF	369	GF422206	UNC	345	GF432556	M	337	GF641007	M, MF	431
GF332406	UNC	373	GF422206	UNF	347	GF432801	EG M (STI)	350	GF641107	M, MF	433
GF332406	UNF	375	GF422251	M	336	GF432801	G (BSP)	348	GF641207	M, MF	435
GF332701	G (BSP)	376	GF422256	M	337	GF432801	M	334	GF641307	M, MF	437
GF332701	M	362	GF422501	EG M (STI)	350	GF432801	MF	340	GF641407	M, MF	439
GF332701	MF	368	GF422501	G (BSP)	348	GF432801	UNC	344	GF643005	G (BSP), BSW, BSF, W	431
GF332701	UNC	372	GF422501	M	334	GF432801	UNF	346	GF643005	M, MF, UN	431
GF332701	UNF	374	GF422501	MF	340	GF432806	EG M (STI)	351	GF643007	G (BSP), BSW, BSF, W	431
GF332706	G (BSP)	377	GF422501	UNC	344	GF432806	G (BSP)	349	GF643007	M, MF, UN	431
GF332706	M	363	GF422501	UNF	346	GF432806	M	335	GF643007	Tr	431
GF332706	MF	369	GF422506	EG M (STI)	351	GF432806	MF	341	GF643105	G (BSP), BSW, BSF, W	433
GF332706	UNC	373	GF422506	G (BSP)	349	GF432806	UNC	345	GF643105	M, MF, UN	433
GF332706	UNF	375	GF422506	M	335	GF432806	UNF	347	GF643107	G (BSP), BSW, BSF, W	433
GF333101	LK-M	378	GF422506	MF	341	GF432851	M	336	GF643107	M, MF, UN	433
GF333101	M	360	GF422506	UNC	345	GF432856	M	337	GF643107	NPT	433



GF643107	Tr	433	GFB35406	UNF, UN	392	GZ349024	439	GZ80H0C4	442
GF643205	G (BSP), BSW, BSF, W	435	GFB35701	M, MF	387	GZ349025	441	GZ80I0C4	442
GF643205	M, MF, UN	435	GFB35701	MF	388	GZ349040	431	GZ80J0C4	442
GF643207	G (BSP), BSW, BSF, W	435	GFB35706	M, MF	387	GZ349041	433		
GF643207	M, MF, UN	435	GFB35706	MF	388	GZ349042	435		
GF643207	NPT	435	GFB35706	UNC, UN	392	GZ349043	437		
GF643207	Tr	435	GFB35706	UNF, UN	392	GZ349044	439		
GF643305	G (BSP), BSW, BSF, W	437	GZ301110		422	GZ349045	441		
GF643305	M, MF, UN	437	GZ301130		422	GZ349053	437		
GF643307	G (BSP), BSW, BSF, W	437	GZ301140		422	GZ349054	439		
GF643307	M, MF, UN	437	GZ301310		422	GZ349055	441		
GF643307	Tr	437	GZ301320		422	GZ34A000	430		
GF643405	G (BSP), BSW, BSF, W	439	GZ301330		422	GZ34A001	432		
GF643405	M, MF, UN	439	GZ301340		422	GZ34A002	434		
GF643407	G (BSP), BSW, BSF, W	439	GZ303010		424	GZ34A003	436		
GF643407	M, MF, UN	439	GZ309010		423	GZ34A010	430		
GF643407	Tr	439	GZ309020		423	GZ34C000	430		
GF643505	M, MF, UN	441	GZ309020		424	GZ34C001	432		
GF643507	M, MF, UN	441	GZ309210		424	GZ34C002	434		
GF643507	Tr	441	GZ311330		425	GZ34C010	430		
GF663005		442	GZ319020		425	GZ34C020	430		
GF663007		442	GZ319060		425	GZ351000	430		
GF663105		442	GZ341000		430	GZ351001	432		
GF663107		442	GZ341001		432	GZ351002	434		
GF663205		442	GZ341012		434	GZ352003	436		
GF663207		442	GZ341021		432	GZ352004	438		
GF663305		442	GZ341032		434	GZ352005	440		
GF663307		442	GZ341040		430	GZ353000	430		
GF663405		442	GZ341050		430	GZ353001	432		
GF663407		442	GZ341101		432	GZ353002	434		
GF732257	M, MF	355	GZ341112		434	GZ353003	436		
GF732257	UNC	356	GZ341121		432	GZ353004	438		
GF732257	UNF	357	GZ341131		432	GZ353005	440		
GF732557	M, MF	355	GZ341143		436	GZ359310	431		
GF732557	UNC	356	GZ341153		436	GZ359311	433		
GF732557	UNF	357	GZ341200		430	GZ359312	435		
GF732857	M, MF	355	GZ341201		432	GZ359313	437		
GF732857	UNC	356	GZ341202		434	GZ359314	439		
GF732857	UNF	357	GZ341211		432	GZ359315	441		
GF733208	M, MF	355	GZ341221		432	GZ5243A4	444		
GF733208	UNC	356	GZ341231		432	GZ5263A4	444		
GF733208	UNF	357	GZ343003		436	GZ5263B4	444		
GF733508	M, MF	355	GZ343014		438	GZ5263B5	444		
GF733508	UNC	356	GZ343103		436	GZ5391A4	444		
GF733508	UNF	357	GZ343114		438	GZ5391B4	444		
GF733808	M, MF	355	GZ344003		436	GZ5391B5	444		
GF733808	UNC	356	GZ344014		438	GZ5521A4	444		
GF733808	UNF	357	GZ344024		438	GZ56E1A4	444		
GF753276	M, MF	354	GZ344035		440	GZ7243AA	445		
GF753576	M, MF	354	GZ344045		440	GZ7243AB	445		
GF753876	M, MF	354	GZ344103		436	GZ7243AC	445		
GF927126	M	389	GZ344114		438	GZ7243AD	445		
GF927426	M	389	GZ344124		438	GZ7263AE	445		
GF927726	M	389	GZ344203		436	GZ7263AF	445		
GFB35101	M, MF	387	GZ344204		438	GZ7391AA	445		
GFB35101	MF	388	GZ349010		431	GZ7391AB	445		
GFB35106	M, MF	387	GZ349011		433	GZ7391AC	445		
GFB35106	MF	388	GZ349012		435	GZ7391AD	445		
GFB35106	UNC, UN	392	GZ349013		437	GZ73A1AE	445		
GFB35106	UNF, UN	392	GZ349014		439	GZ73A1AF	445		
GFB35401	M, MF	387	GZ349015		441	GZ7521AB	445		
GFB35401	MF	388	GZ349020		431	GZ7521AC	445		
GFB35406	M, MF	387	GZ349021		433	GZ75D1AA	445		
GFB35406	MF	388	GZ349022		435	GZ80F0C4	442		
GFB35406	UNC, UN	392	GZ349023		437	GZ80G0C4	442		
								H	
								H0101001	BSF 208
								H0101001	BSW 205
								H0101001	M 92
								H0101001	UNC 149
								H0111001	BSF 208
								H0111001	BSW 205
								H0111001	M 92
								H0111001	UNC 149
								H0111019	BSF 208
								H0111019	BSW 205
								H0111019	M 92
								H0111019	UNC 149
								H0111029	BSF 208
								H0111029	BSW 205
								H0111029	M 92
								H0111029	UNC 149
								H0201001	G (BSP) 175
								H0201001	MF 132-133
								H0201001	UNF 161
								H0201051	MF-LH 134
								H0211001	G (BSP) 175
								H0211001	MF 132-133
								H0211001	UNF 161
								H0211009	G (BSP) 175
								H0211009	MF 132-133
								H0211009	UNF 161
								H0211051	MF-LH 134
								H0211059	MF-LH 134
								H0300901	M 93
								H0310901	M 93
								H0310919	M 93
								H0310929	M 93
								H0320901	MF 135
								H0330901	MF 135
								H0330909	MF 135
								H0403001	M 95
								H0403001	UNC 151
								H0403101	M 97
								H0407101	M 99
								H0413019	M 94
								H0413019	UNC 150
								H0413119	M 96
								H0417119	M 98
								H0423001	M 94
								H0423001	UNC 150
								H0423019	M 94
								H0423019	UNC 150
								H0423029	M 94
								H0423029	UNC 150
								H0423101	M 96
								H0423119	M 96
								H0423129	M 96
								H0427101	M 98
								H0427119	M 98
								H0427129	M 98
								H0433001	M 95



H0433001	UNC	151
H0433101	M	97
H0437101	M	99
H0453001	G (BSP)	177
H0453001	M	95
H0453001	MF	137
H0453001	UNC	151
H0453001	UNF	163
H0453101	M	97
H0463009	G (BSP)	176
H0463009	MF	136
H0463009	UNF	162
H0473001	G (BSP)	176
H0473001	MF	136
H0473001	UNF	162
H0473009	G (BSP)	176
H0473009	MF	136
H0473009	UNF	162
H0483001	G (BSP)	177
H0483001	M	95
H0483001	MF	137
H0483001	UNC	151
H0483001	UNF	163
H0483101	M	97

L

L0091040		628
L0091070		628
L0091410		629
L0091500		629
L0091510		629
L0100100	BSW	614
L0100100	EG M (STI)	617
L0100100	G (BSP)	610
L0100100	LK-M	618
L0100100	M	584
L0100100	MF	588-589
L0100100	Tr	619
L0100100	Tr-F	620
L0100100	UNC	606
L0100100	UNF	608
L0100110	M „4H“	584
L0100110	MF „4H“	588-589
L0100110	MJ	616
L0100110	UNC „3B“	606
L0100110	UNF „3B“	608
L0100110	UNJC	616
L0100110	UNJF	616
L0100120	M „6G“	585
L0100120	MF „6G“	588-589
L0100130	M „6E“	585
L0100150	M-LH	585
L0100150	MF-LH	588-589
L0100160	MF-LH „4H“	588-589
L0100170	MF-LH „6G“	588-589
L0100200	Rd	621
L0101100	M	584
L0101100	MF	588-589
L0101110	M „4H“	584
L0101120	M „6G“	585

L0105100	M	584
L0105100	MF	588-589
L0105110	M „4H“	584
L0105120	M „6G“	585
L0120100	BSW	614
L0120100	G (BSP)	610
L0120100	M	585
L0120100	MF	590-596
L0120100	Pg	615
L0120100	Tr	619
L0120100	Tr-F	620
L0120100	UNC	606
L0120100	UNF	608
L0120110	MF „4H“	590-596
L0120120	MF „6G“	590-596
L0120150	MF-LH	590-596
L0120160	MF-LH „4H“	591-597
L0120170	MF-LH „6G“	591-597
L0120200	Rd	621
L0121100	M	585
L0121100	MF	590-596
L0125100	M	585
L0125100	MF	590-596
L0140100	BSW	614
L0140100	G (BSP)	610
L0140100	M	585
L0140100	MF	591-597
L0140100	Tr	619
L0140100	Tr-F	620
L0140100	UNC	606
L0140100	UNF	608
L0140110	MF „4H“	591-597
L0140120	MF „6G“	591-597
L0140150	MF-LH	591-597
L0140160	MF-LH „4H“	591-597
L0140170	MF-LH „6G“	591-597
L0140200	Rd	621
L0160100	M	623
L0160105	M	623
L0180100	Pg	615
L0190100	Pg	615
L0200500	BSW	614
L0200500	G (BSP)	610
L0200500	M	586
L0200500	MF	598-604
L0200500	Pg	615
L0200500	Tr	619
L0200500	Tr-F	620
L0200500	UNC	607
L0200500	UNF	609
L0200501	MF „6h“	598-604
L0200510	M „4h“	586
L0200510	MF „4h“	598-604
L0200510	UNC „3A“	607
L0200510	UNF „3A“	609
L0200530	M „6e“	586
L0200530	MF „6e“	598-604
L0200550	M-LH	586
L0200550	MF-LH	598-604
L0200560	MF-LH „4h“	598-604
L0200580	MF-LH „6e“	598-604
L0200600	Rd	621
L0300500	BSW	614
L0300500	G (BSP)	610
L0300500	M	587

L0300500	MF	599-605
L0300500	Tr	619
L0300500	Tr-F	620
L0300500	UNC	607
L0300500	UNF	609
L0300501	MF „6h“	599-605
L0300510	M „4h“	587
L0300510	MF „4h“	599-605
L0300510	UNC „3A“	607
L0300510	UNF „3A“	609
L0300530	M „6e“	587
L0300530	MF „6e“	599-605
L0300550	M-LH	587
L0300550	MF-LH	599-605
L0300560	MF-LH „4h“	599-605
L0300580	MF-LH „6e“	599-605
L0300600	Rd	621
L0320500	Pg	615
L0500100	NPT	612
L0500100	NPTF	613
L0510100	NPTF	613
L0520100	NPTF	613
L0600500	NPT	612
L0600500	NPTF	613
L1010100	G (BSP)	627
L1010100	M	624
L1010100	UNC	625
L1010100	UNF	626
L1020200	G (BSP)	627
L1020200	M	624
L1020200	UNC	625
L1020200	UNF	626
L1040100	G (BSP)	627
L1040100	M	624
L1040100	UNC	625
L1040100	UNF	626
L1050200	G (BSP)	627
L1050200	M	624
L1050200	UNC	625
L1050200	UNF	626
L14000H7	DIN 2245 Z	622
L14200H7	DIN 2246 ZG	622
L14400H7	DIN 2247 ZA	622
L1800101	Rp, Rc	611
L1815101	Rp, Rc	611
L1830501		611
L1850501	R	611
L1860501	R	611
L1870101		611

M

M0101000	M	101
M0601000	M	100
M0601000	MF	139
M0621000	M	100

Q

QB002002	794
QB002003	794

T

TA103324	524-527
TA107725	558
TA203344	528-531
TA204524	546-549
TA212444	554-557
TA213344	532-535
TA214524	550-553
TA223344	536-539
TA403324	524-527
TA503344	528-531
TA504524	546-549
TA512444	554-557
TA513344	532-535
TA514524	550-553
TCHDHS63	564
TCHDRD20	565
TCHDSK40	565
TCHDSK50	565
TCWNHS63	562
TCWNSK40	563
TCWNSK50	563
TE213324	523
TG203344	560
TG204524	561
TM003324	540-543
TM200000	544
TM210000	545
TM500000	544
TM510000	545
TM909090	544-545
TM909191	544-545
TM909192	544-545
TM909293	544-545
TM909394	544-545
TM909395	544-545
TM919099	544-545
TM919199	544-545
TM919299	544-545
TM919399	544-545
TWA01001	562
TWA01002	564
TWA02001	562
TWA03001	566
TWA03002	566
TWA03003	566
TWA04001	563, 565
TWB03001	562, 564
TWB03002	562, 564



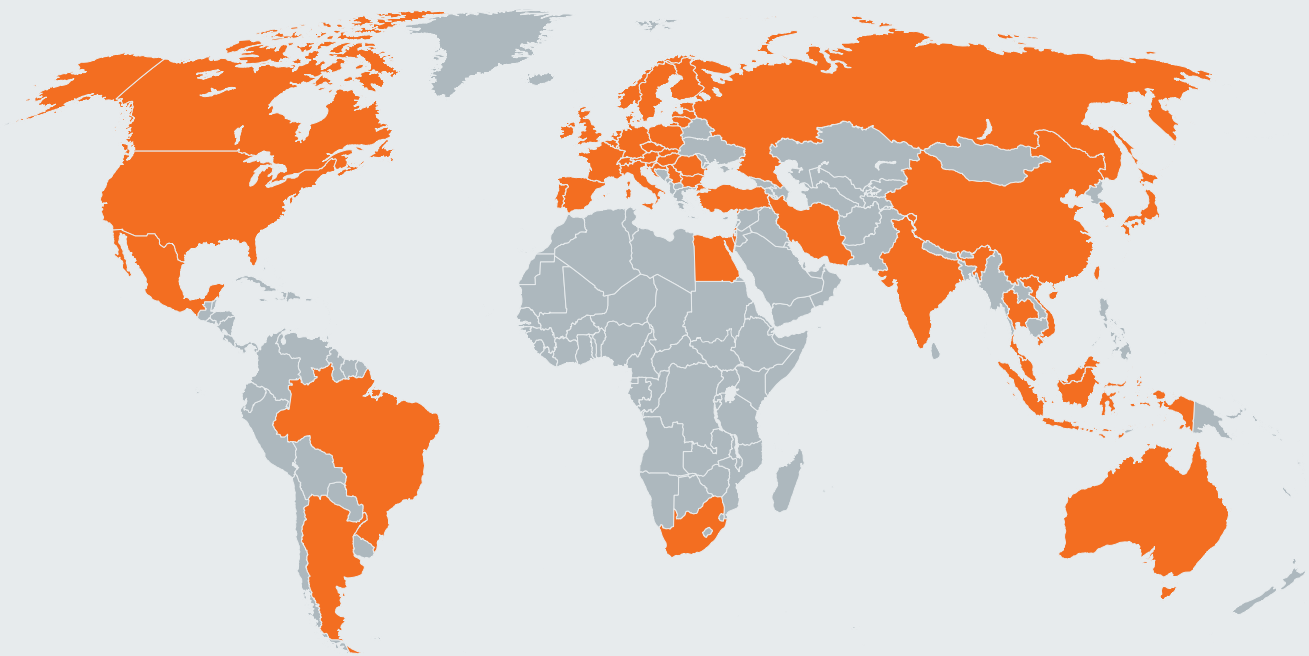

EMUGE-FRANKEN Vertriebspartner finden Sie auf www.emuge-franken.com/vertrieb
EMUGE-FRANKEN sales partners, please see www.emuge-franken.com/sales

EMUGE-Werk Richard Glimpel GmbH & Co. KG
Fabrik für Präzisionswerkzeuge

🏠 Nürnberger Straße 96-100
91207 Lauf
GERMANY

☎ +49 (0) 9123 / 186-0
📠 +49 (0) 9123 / 14313

FRANKEN GmbH & Co. KG
Fabrik für Präzisionswerkzeuge

🏠 Frankenstraße 7/9a
90607 Rückersdorf
GERMANY

☎ +49 (0) 911 / 9575-5
📠 +49 (0) 911 / 9575-327

✉ info@emuge-franken.com 🌐 www.emuge-franken.com